

### TRENCHSTOP™ 5 WR6 technology in enhanced creepage and clearance package offers improved reliability against package contamination

#### Features

- $V_{CE} = 650\text{ V}$
- $I_C = 60\text{ A}$
- Pin-to-pin creepage distance > 4.8 mm
- Pin-to-pin clearance distance > 3.4 mm
- Monolithic diode optimized for PFC and welding applications
- Stable temperature behavior
- Very low  $V_{CEsat}$  and low  $E_{off}$
- Easy paralleling capability due to positive temperature coefficient in  $V_{CEsat}$
- Low temperature dependence of  $V_{CEsat}$  and  $E_{sw}$
- Product spectrum and PSpice Models: <http://www.infineon.com/igbt/>

#### Potential applications

- PFC
- Welding
- ZCS applications

#### Product validation

- Qualified for industrial applications according to the relevant tests of JEDEC47/20/22

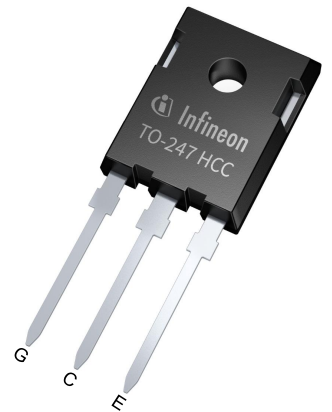

- Lead-free
- Green
- Halogen-free
- RoHS

#### Description

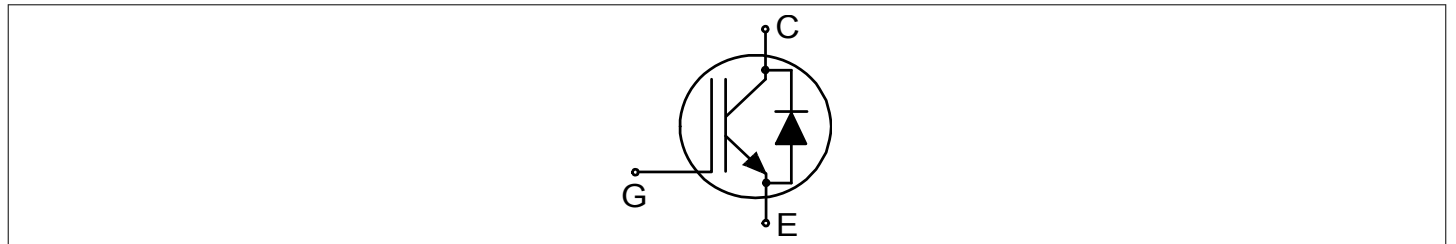

Type	Package	Marking
IKWH60N65WR6	PG-TO247-3-STD-NN4.8	H60EWR6

## Table of contents

	<b>Description</b> .....	1
	<b>Features</b> .....	1
	<b>Potential applications</b> .....	1
	<b>Product validation</b> .....	1
	<b>Table of contents</b> .....	2
<b>1</b>	<b>Package</b> .....	3
<b>2</b>	<b>IGBT</b> .....	3
<b>3</b>	<b>Diode</b> .....	5
<b>4</b>	<b>Characteristics diagrams</b> .....	7
<b>5</b>	<b>Package outlines</b> .....	14
<b>6</b>	<b>Testing conditions</b> .....	15
	<b>Revision history</b> .....	16
	<b>Disclaimer</b> .....	17

## 1 Package

**Table 1** Characteristic values

Parameter	Symbol	Note or test condition	Values			Unit
			Min.	Typ.	Max.	
Internal emitter inductance measured 5 mm (0.197 in.) from case	$L_E$			13		nH
Storage temperature	$T_{stg}$		-55		150	°C
Soldering temperature	$T_{sold}$	wave soldering 1.6 mm (0.063 in.) from case for 10 s			260	°C
Mounting torque	$M$	M3 screw, Maximum of mounting process: 3			0.6	Nm
Thermal resistance, junction-ambient	$R_{th(j-a)}$				40	K/W
IGBT thermal resistance, junction-case	$R_{th(j-c)}$				0.6	K/W
Diode thermal resistance, junction-case	$R_{th(j-c)}$				2.3	K/W

## 2 IGBT

**Table 2** Maximum rated values

Parameter	Symbol	Note or test condition	Values	Unit	
Collector-emitter voltage	$V_{CE}$	$T_{vj} \geq 25\text{ °C}$	650	V	
DC collector current, limited by $T_{vjmax}$	$I_C$		$T_c = 25\text{ °C}$	100	A
			$T_c = 100\text{ °C}$	63	
Pulsed collector current, $t_p$ limited by $T_{vjmax}$	$I_{Cpulse}$		180	A	
Turn-off safe operating area		$V_{CE} \leq 650\text{ V}, T_{vj} \leq 175\text{ °C}$	180	A	
Gate-emitter voltage	$V_{GE}$		$\pm 20$	V	
Transient gate-emitter voltage	$V_{GE}$	$t_p \leq 10\text{ }\mu\text{s}, D < 0.01$	$\pm 30$	V	
Power dissipation	$P_{tot}$		$T_c = 25\text{ °C}$	240	W
			$T_c = 100\text{ °C}$	120	

**Table 3** Characteristic values

Parameter	Symbol	Note or test condition	Values			Unit
			Min.	Typ.	Max.	
Collector-emitter breakdown voltage	$V_{BRCES}$	$I_C = 0.2\text{ mA}, V_{GE} = 0\text{ V}$	650			V

(table continues...)

Table 3 (continued) Characteristic values

Parameter	Symbol	Note or test condition		Values			Unit
				Min.	Typ.	Max.	
Collector-emitter saturation voltage	$V_{CEsat}$	$I_C = 60\text{ A}, V_{GE} = 15\text{ V}$	$T_{vj} = 25\text{ °C}$		1.55	1.85	V
			$T_{vj} = 175\text{ °C}$		1.8		
Gate-emitter threshold voltage	$V_{GETh}$	$I_C = 0.6\text{ mA}, V_{CE} = V_{GE}$		3.2	4	4.8	V
Zero gate-voltage collector current	$I_{CES}$	$V_{CE} = 650\text{ V}, V_{GE} = 0\text{ V}$	$T_{vj} = 25\text{ °C}$			40	$\mu\text{A}$
			$T_{vj} = 175\text{ °C}$		0.5		mA
Gate-emitter leakage current	$I_{GES}$	$V_{CE} = 0\text{ V}, V_{GE} = 20\text{ V}$				100	nA
Transconductance	$g_{fs}$	$I_C = 60\text{ A}, V_{CE} = 20\text{ V}$			150		S
Input capacitance	$C_{ies}$	$V_{CE} = 25\text{ V}, V_{GE} = 0\text{ V}, f = 100\text{ kHz}$			4270		pF
Output capacitance	$C_{oes}$	$V_{CE} = 25\text{ V}, V_{GE} = 0\text{ V}, f = 100\text{ kHz}$			44		pF
Reverse transfer capacitance	$C_{res}$	$V_{CE} = 25\text{ V}, V_{GE} = 0\text{ V}, f = 100\text{ kHz}$			19		pF
Gate charge	$Q_G$	$I_C = 60\text{ A}, V_{GE} = 15\text{ V}, V_{CC} = 520\text{ V}$			174		nC
Turn-on delay time	$t_{d(on)}$	$V_{CC} = 400\text{ V}, V_{GE} = 0/15\text{ V}, R_{G(on)} = 15\ \Omega, R_{G(off)} = 15\ \Omega, L_\sigma = 30\text{ nH}, C_\sigma = 31\text{ pF}$	$T_{vj} = 25\text{ °C}, I_C = 60\text{ A}$		35		ns
			$T_{vj} = 175\text{ °C}, I_C = 60\text{ A}$		32		
Rise time (inductive load)	$t_r$	$V_{CC} = 400\text{ V}, V_{GE} = 0/15\text{ V}, R_{G(on)} = 15\ \Omega, R_{G(off)} = 15\ \Omega, L_\sigma = 30\text{ nH}, C_\sigma = 31\text{ pF}$	$T_{vj} = 25\text{ °C}, I_C = 60\text{ A}$		28		ns
			$T_{vj} = 175\text{ °C}, I_C = 60\text{ A}$		30		
Turn-off delay time	$t_{d(off)}$	$V_{CC} = 400\text{ V}, V_{GE} = 0/15\text{ V}, R_{G(on)} = 15\ \Omega, R_{G(off)} = 15\ \Omega, L_\sigma = 30\text{ nH}, C_\sigma = 31\text{ pF}$	$T_{vj} = 25\text{ °C}, I_C = 60\text{ A}$		311		ns
			$T_{vj} = 175\text{ °C}, I_C = 60\text{ A}$		344		
Fall time (inductive load)	$t_f$	$V_{CC} = 400\text{ V}, V_{GE} = 0/15\text{ V}, R_{G(on)} = 15\ \Omega, R_{G(off)} = 15\ \Omega, L_\sigma = 30\text{ nH}, C_\sigma = 31\text{ pF}$	$T_{vj} = 25\text{ °C}, I_C = 60\text{ A}$		23		ns
			$T_{vj} = 175\text{ °C}, I_C = 60\text{ A}$		20		
Turn-on energy	$E_{on}$	$V_{CC} = 400\text{ V}, V_{GE} = 0/15\text{ V}, R_{G(on)} = 15\ \Omega, R_{G(off)} = 15\ \Omega, L_\sigma = 30\text{ nH}, C_\sigma = 31\text{ pF}$	$T_{vj} = 25\text{ °C}, I_C = 60\text{ A}$		1.82		mJ
			$T_{vj} = 175\text{ °C}, I_C = 60\text{ A}$		2.04		

(table continues...)

**Table 3 (continued) Characteristic values**

Parameter	Symbol	Note or test condition	Values			Unit	
			Min.	Typ.	Max.		
Turn-off energy	$E_{off}$	$V_{CC} = 400\text{ V}, V_{GE} = 0/15\text{ V},$ $R_{G(on)} = 15\ \Omega,$ $R_{G(off)} = 15\ \Omega, L_{\sigma} = 30\text{ nH},$ $C_{\sigma} = 31\text{ pF}$	$T_{vj} = 25\text{ }^{\circ}\text{C},$ $I_C = 60\text{ A}$		0.85		mJ
			$T_{vj} = 175\text{ }^{\circ}\text{C},$ $I_C = 60\text{ A}$		1.17		
Total switching energy	$E_{ts}$	$V_{CC} = 400\text{ V}, V_{GE} = 0/15\text{ V},$ $R_{G(on)} = 15\ \Omega,$ $R_{G(off)} = 15\ \Omega, L_{\sigma} = 30\text{ nH},$ $C_{\sigma} = 31\text{ pF}$	$T_{vj} = 25\text{ }^{\circ}\text{C},$ $I_C = 60\text{ A}$		2.67		mJ
			$T_{vj} = 175\text{ }^{\circ}\text{C},$ $I_C = 60\text{ A}$		3.21		
Operating junction temperature	$T_{vj}$		-40		175	$^{\circ}\text{C}$	

Note: Electrical Characteristic, at  $T_{vj} = 25\text{ }^{\circ}\text{C}$ , unless otherwise specified.

### 3 Diode

**Table 4 Maximum rated values**

Parameter	Symbol	Note or test condition	Values	Unit	
Repetitive peak reverse voltage	$V_{RRM}$	$T_{vj} \geq 25\text{ }^{\circ}\text{C}$	650	V	
Diode forward current, limited by $T_{vjmax}$	$I_F$		$T_c = 25\text{ }^{\circ}\text{C}$	32	A
			$T_c = 100\text{ }^{\circ}\text{C}$	19	
Diode pulsed current, $t_p$ limited by $T_{vjmax}$	$I_{Fpulse}$		60	A	

**Table 5 Characteristic values**

Parameter	Symbol	Note or test condition	Values			Unit	
			Min.	Typ.	Max.		
Diode forward voltage	$V_F$	$I_F = 16\text{ A}$	$T_{vj} = 25\text{ }^{\circ}\text{C}$		1.3	1.6	V
			$T_{vj} = 175\text{ }^{\circ}\text{C}$		1.3		
Diode reverse recovery time	$t_{rr}$	$V_R = 400\text{ V}, R_{G(on)} = 15\ \Omega$	$T_{vj} = 25\text{ }^{\circ}\text{C},$ $I_F = 30\text{ A},$ $-di_F/dt = 1700\text{ A}/\mu\text{s}$		92		ns
			$T_{vj} = 175\text{ }^{\circ}\text{C},$ $I_F = 30\text{ A},$ $-di_F/dt = 1600\text{ A}/\mu\text{s}$		121		

(table continues...)

Table 5 (continued) Characteristic values

Parameter	Symbol	Note or test condition		Values			Unit
				Min.	Typ.	Max.	
Diode reverse recovery charge	$Q_{rr}$	$V_R = 400 \text{ V}, R_{G(on)} = 15 \Omega$	$T_{vj} = 25 \text{ }^\circ\text{C},$ $I_F = 30 \text{ A},$ $-di_F/dt = 1700 \text{ A}/\mu\text{s}$		2.3		$\mu\text{C}$
			$T_{vj} = 175 \text{ }^\circ\text{C},$ $I_F = 30 \text{ A},$ $-di_F/dt = 1600 \text{ A}/\mu\text{s}$		3.8		
Diode peak reverse recovery current	$I_{rrm}$	$V_R = 400 \text{ V}, R_{G(on)} = 15 \Omega$	$T_{vj} = 25 \text{ }^\circ\text{C},$ $I_F = 30 \text{ A},$ $-di_F/dt = 1700 \text{ A}/\mu\text{s}$		34		A
			$T_{vj} = 175 \text{ }^\circ\text{C},$ $I_F = 30 \text{ A},$ $-di_F/dt = 1600 \text{ A}/\mu\text{s}$		48.3		
Diode peak rate of fall of reverse recovery current	$di_{rr}/dt$	$V_R = 400 \text{ V}, R_{G(on)} = 15 \Omega$	$T_{vj} = 25 \text{ }^\circ\text{C},$ $I_F = 30 \text{ A},$ $-di_F/dt = 1700 \text{ A}/\mu\text{s}$		450		$\text{A}/\mu\text{s}$
			$T_{vj} = 175 \text{ }^\circ\text{C},$ $I_F = 30 \text{ A},$ $-di_F/dt = 1600 \text{ A}/\mu\text{s}$		900		
Operating junction temperature	$T_{vj}$			-40		175	$^\circ\text{C}$

Note: For optimum lifetime and reliability, Infineon recommends operating conditions that do not exceed 80% of the maximum ratings stated in this datasheet.

## 4 Characteristics diagrams

### Reverse bias safe operating area

$$I_C = f(V_{CE})$$

$$T_{vj} \leq 175\text{ °C}, T_c = 25\text{ °C}, V_{GE} = 15\text{ V}$$

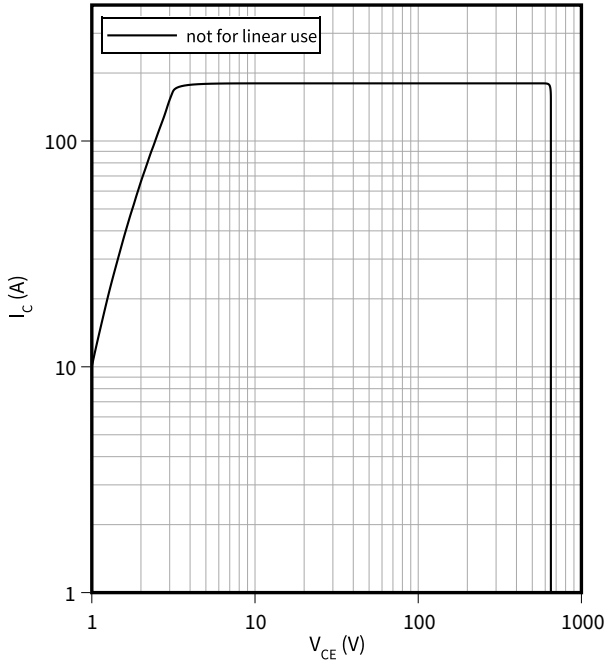

### Power dissipation as a function of case temperature

$$P_{tot} = f(T_c)$$

$$T_{vj} \leq 175\text{ °C}$$

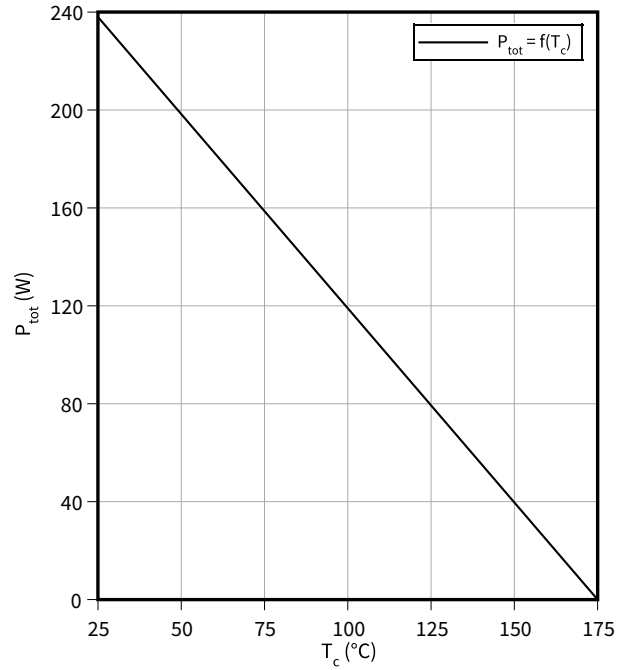

### Collector current as a function of case temperature

$$I_C = f(T_c)$$

$$T_{vj} \leq 175\text{ °C}, V_{GE} \geq 15\text{ V}$$

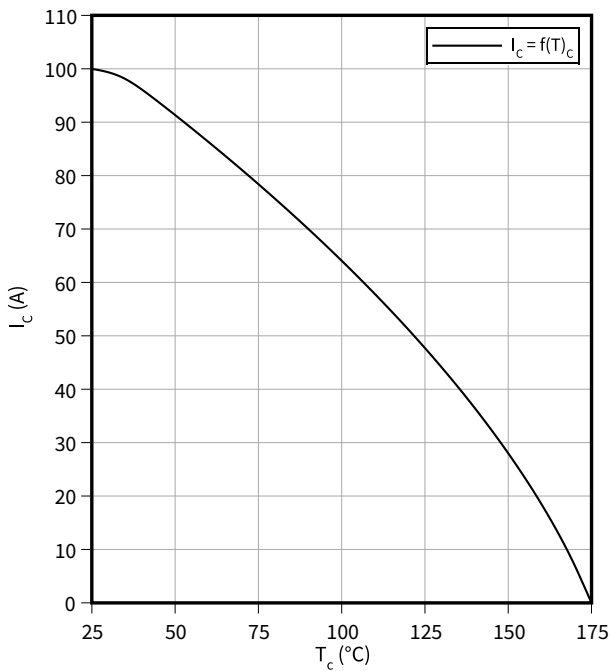

### Typical output characteristic

$$I_C = f(V_{CE})$$

$$T_{vj} = 25\text{ °C}$$

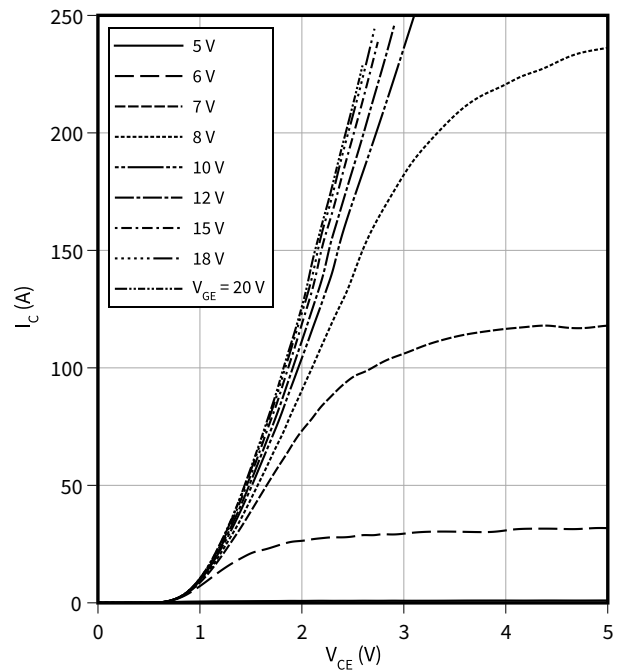

4 Characteristics diagrams

**Typical output characteristic**

$I_C = f(V_{CE})$   
 $T_{vj} = 175\text{ °C}$

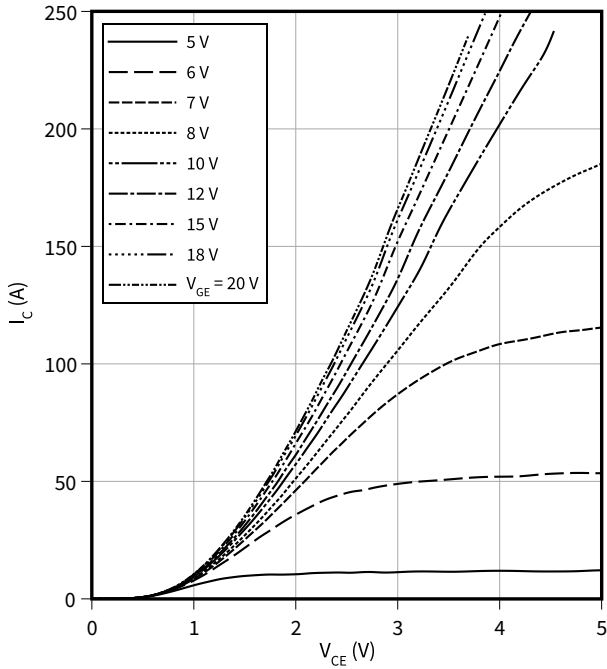

**Typical transfer characteristic**

$I_C = f(V_{GE})$   
 $V_{CE} = 20\text{ V}$

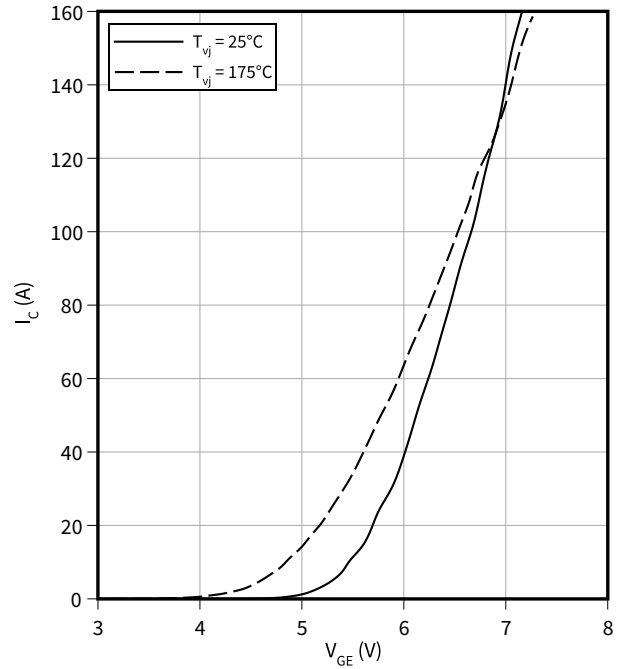

**Typical collector-emitter saturation voltage as a function of junction temperature**

$V_{CEsat} = f(T_{vj})$   
 $V_{GE} = 15\text{ V}$

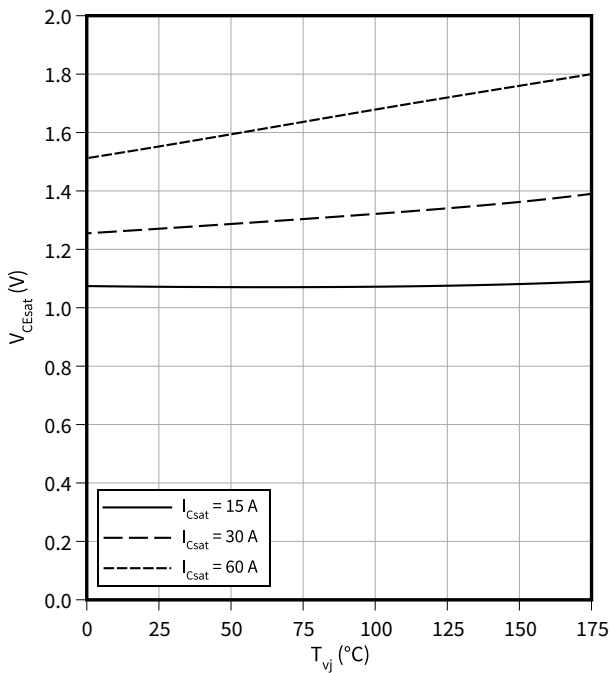

**Gate-emitter threshold voltage as a function of junction temperature**

$V_{GEth} = f(T_{vj})$   
 $I_C = 0.2\text{ mA}$

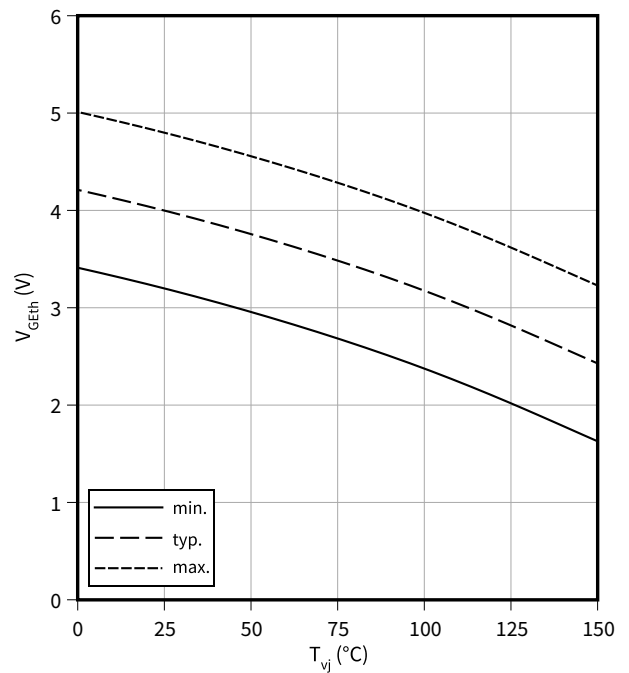



4 Characteristics diagrams

**Typical switching times as a function of collector current**

$t = f(I_C)$

$V_{CC} = 400\text{ V}, T_{vj} = 175\text{ °C}, V_{GE} = 0/15\text{ V}, R_G = 15\text{ }\Omega$

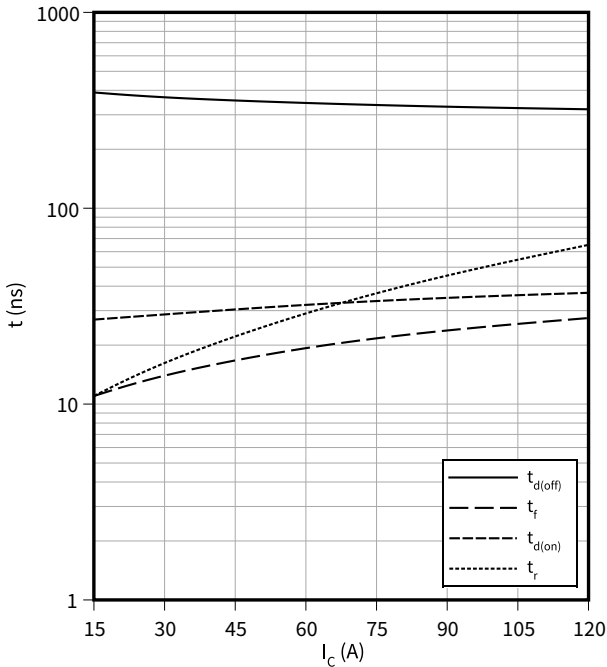

**Typical switching times as a function of gate resistor**

$t = f(R_G)$

$I_C = 60\text{ A}, V_{CC} = 400\text{ V}, T_{vj} = 175\text{ °C}, V_{GE} = 0/15\text{ V}$

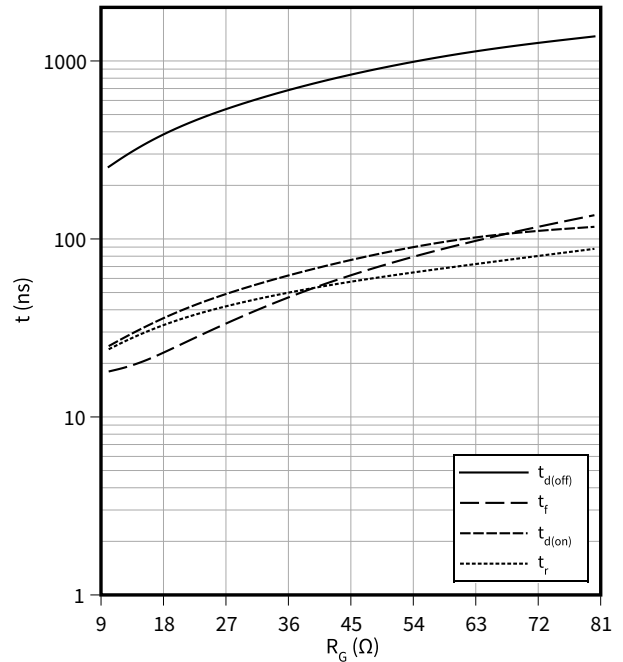

**Typical switching times as a function of junction temperature**

$t = f(T_{vj})$

$I_C = 60\text{ A}, V_{CC} = 400\text{ V}, V_{GE} = 0/15\text{ V}, R_G = 15\text{ }\Omega$

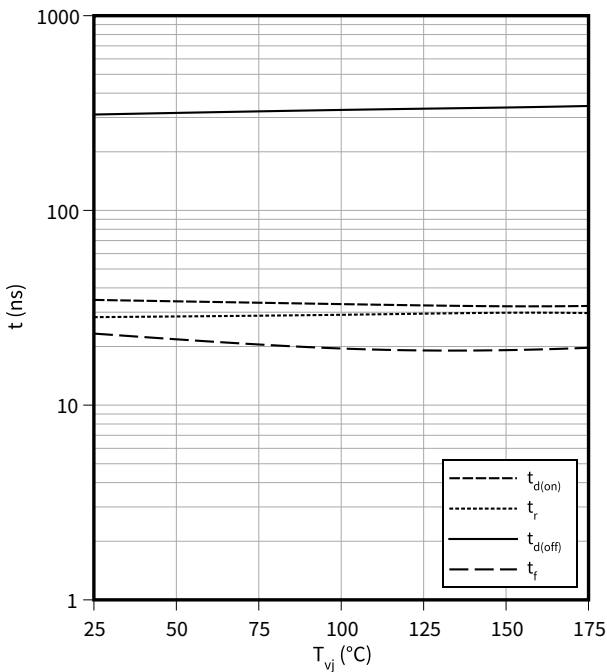

**Typical switching energy losses as a function of collector current**

$E = f(I_C)$

$V_{CC} = 400\text{ V}, T_{vj} = 175\text{ °C}, V_{GE} = 0/15\text{ V}, R_G = 15\text{ }\Omega$

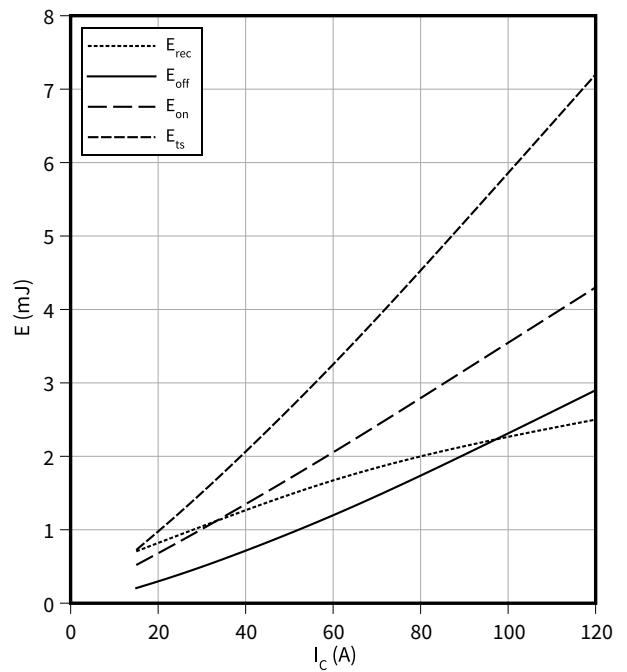

4 Characteristics diagrams

**Typical switching energy losses as a function of gate resistor**

$E = f(R_G)$

$I_C = 60\text{ A}, V_{CC} = 400\text{ V}, T_{vj} = 175\text{ }^\circ\text{C}, V_{GE} = 0/15\text{ V}$

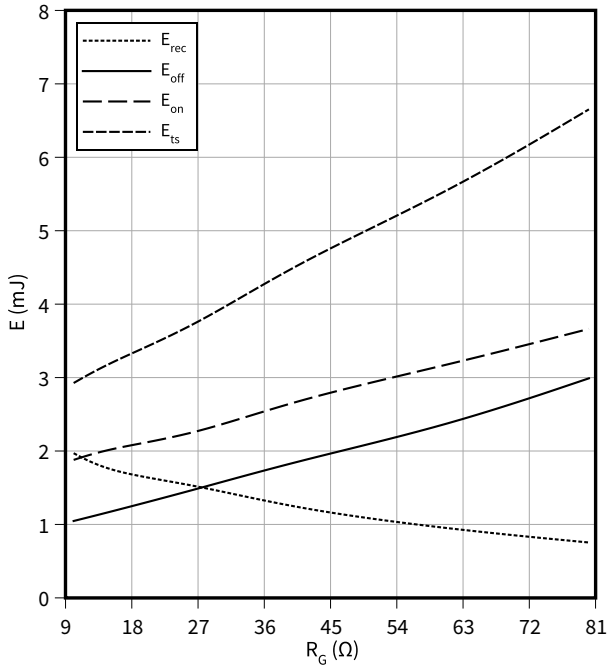

**Typical switching energy losses as a function of junction temperature**

$E = f(T_{vj})$

$I_C = 60\text{ A}, V_{CC} = 400\text{ V}, V_{GE} = 0/15\text{ V}, R_G = 15\text{ }\Omega$

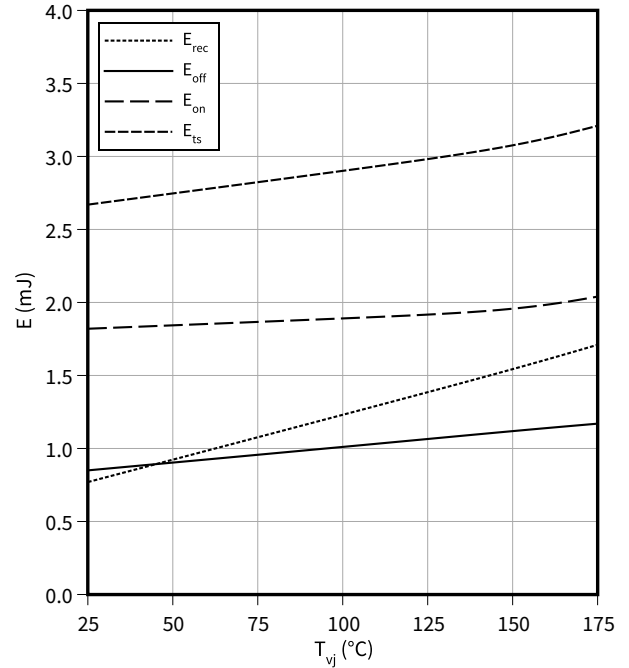

**Typical switching energy losses as a function of collector emitter voltage**

$E = f(V_{CE})$

$I_C = 60\text{ A}, T_{vj} = 175\text{ }^\circ\text{C}, V_{GE} = 0/15\text{ V}, R_G = 15\text{ }\Omega$

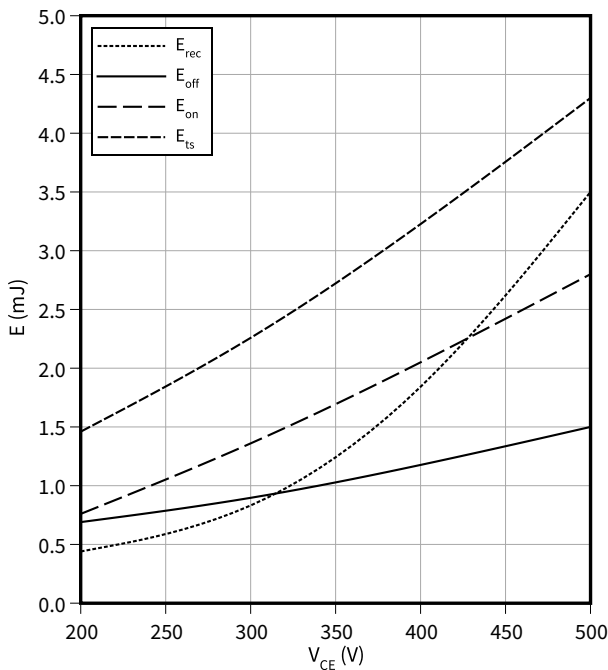

**Typical gate charge**

$V_{GE} = f(Q_G)$

$I_C = 60\text{ A}$

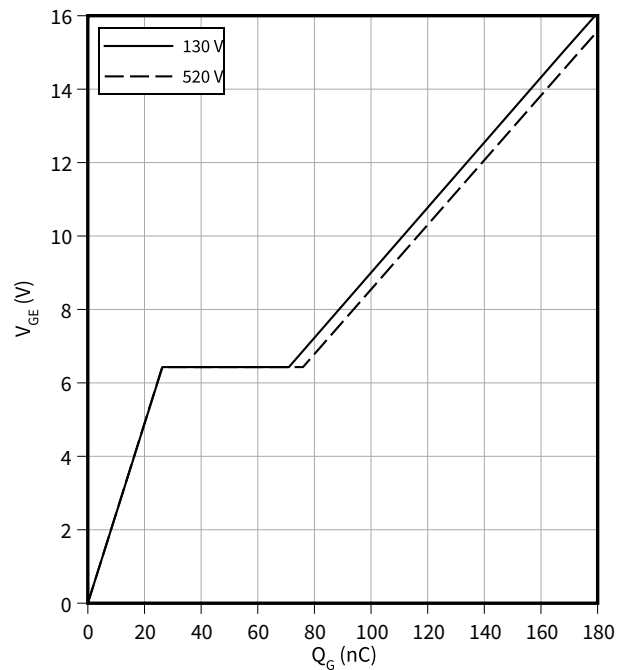

4 Characteristics diagrams

**Typical capacitance as a function of collector-emitter voltage**

$C = f(V_{CE})$

$f = 100 \text{ kHz}, V_{GE} = 0 \text{ V}$

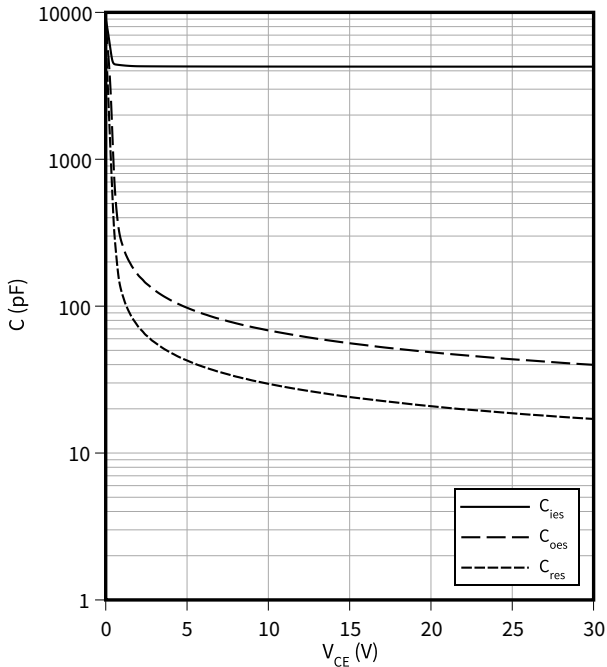

**IGBT transient thermal impedance as a function of pulse width**

$Z_{th(j-c)} = f(t_p)$

$D = t_p/T$

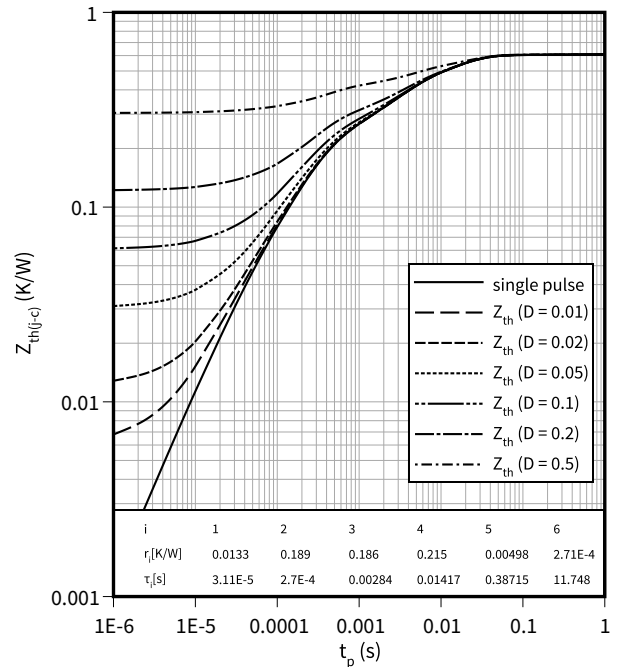

**Diode transient thermal impedance as a function of pulse width**

$Z_{th(j-c)} = f(t_p)$

$D = t_p/T$

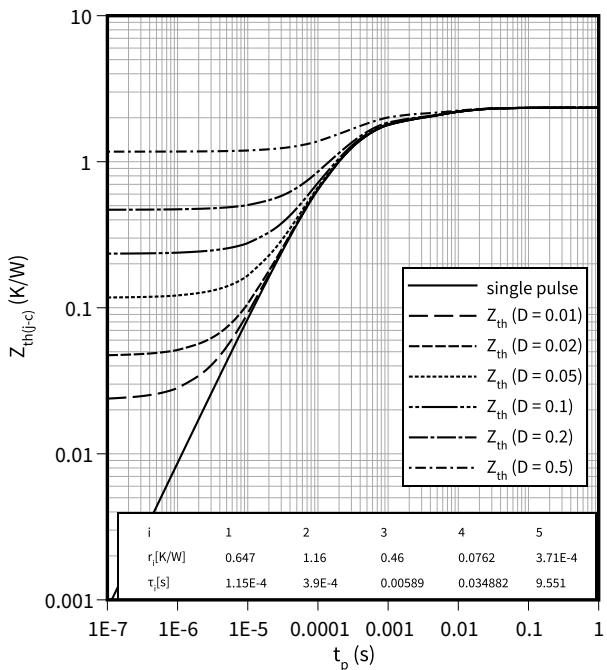

**Typical diode forward current as a function of forward voltage**

$I_F = f(V_F)$

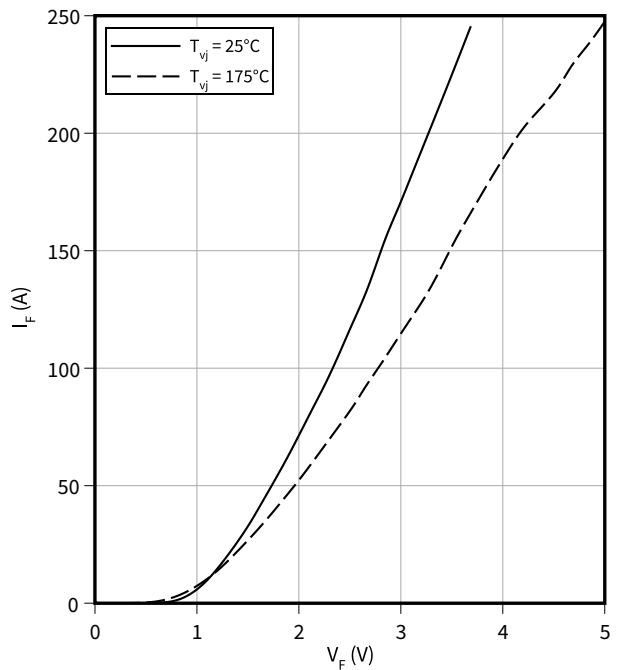

4 Characteristics diagrams

**Typical diode forward voltage as a function of junction temperature**

$V_F = f(T_{vj})$

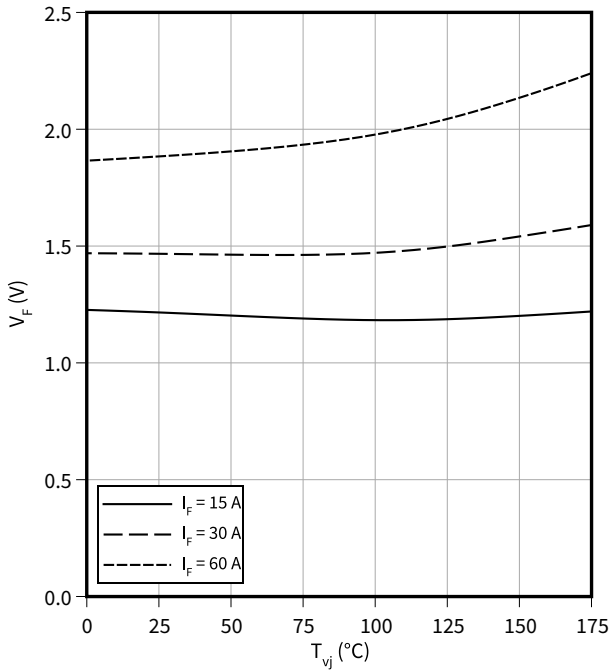

**Typical reverse recovery time as a function of diode current slope**

$t_{rr} = f(di_F/dt)$

$V_R = 400$  V,  $I_F = 30$  A

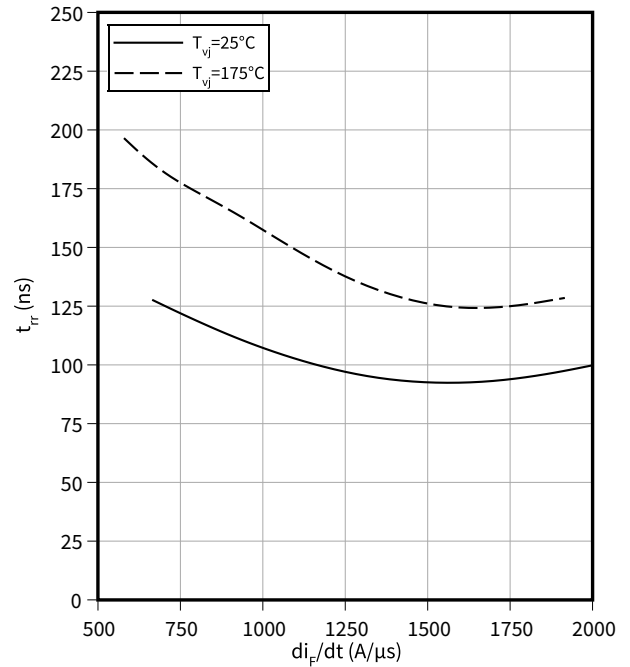

**Typical reverse recovery charge as a function of diode current slope**

$Q_{rr} = f(di_F/dt)$

$V_R = 400$  V,  $I_F = 30$  A

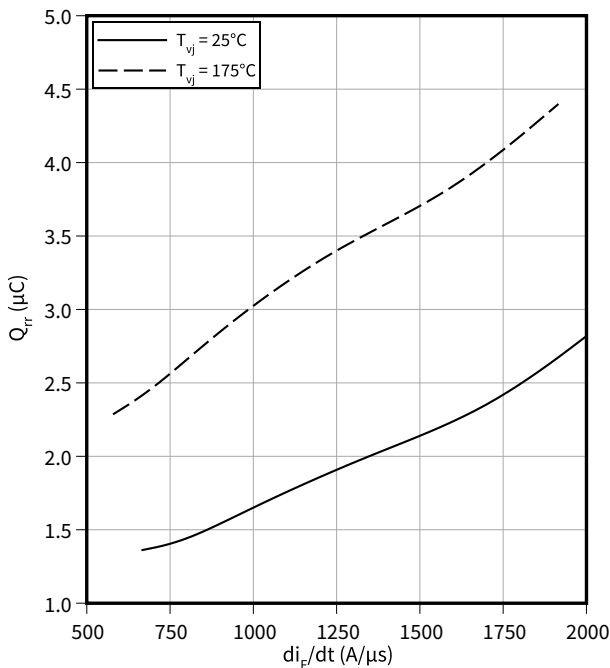

**Typical reverse recovery current as a function of diode current slope**

$I_{rrm} = f(di_F/dt)$

$V_R = 400$  V,  $I_F = 30$  A

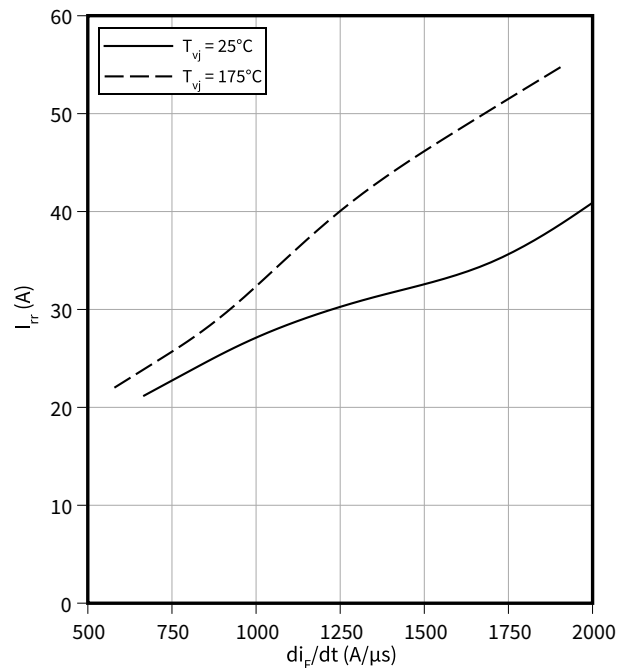

4 Characteristics diagrams

**Typical diode peak rate of fall of reverse recovery current as a function of diode current slope**

$di_{rr}/dt = f(di_F/dt)$

$V_R = 400\text{ V}, I_F = 30\text{ A}$

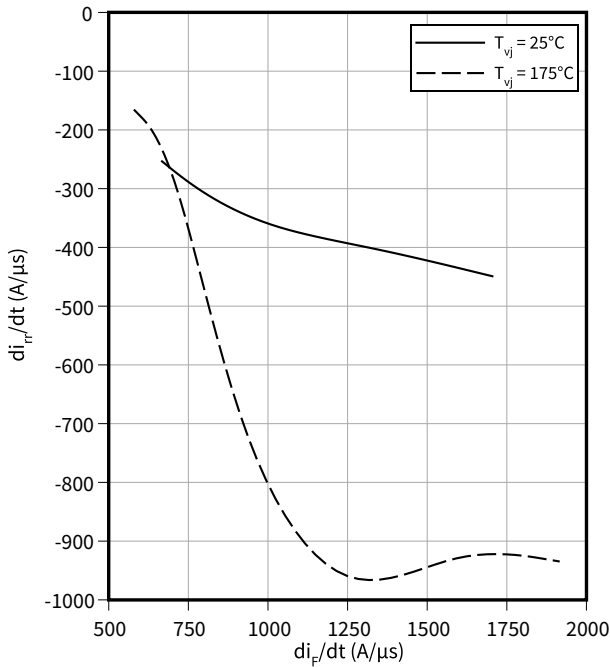

**Typical reverse energy losses as a function of diode current slope**

$E_{rec} = f(di_F/dt)$

$V_R = 400\text{ V}, I_F = 30\text{ A}$

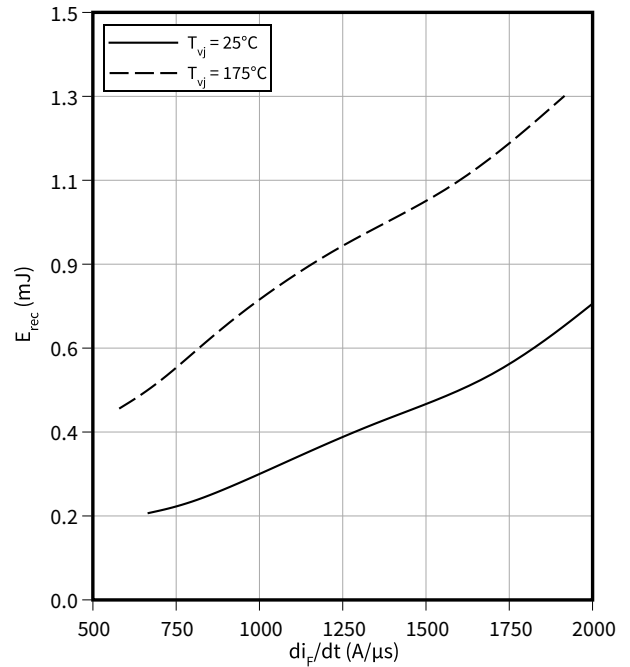

**Typical diode current slope as a function of gate resistor**

$di_F/dt = f(R_G)$

$V_R = 400\text{ V}, I_F = 30\text{ A}$

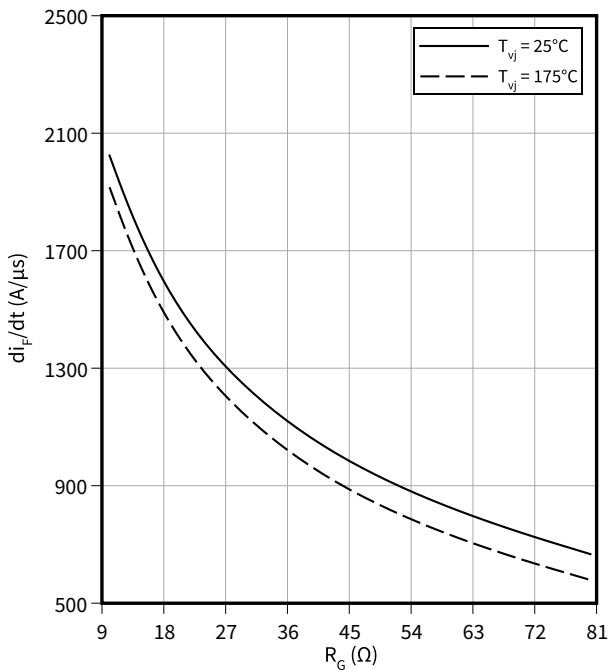

5 Package outlines

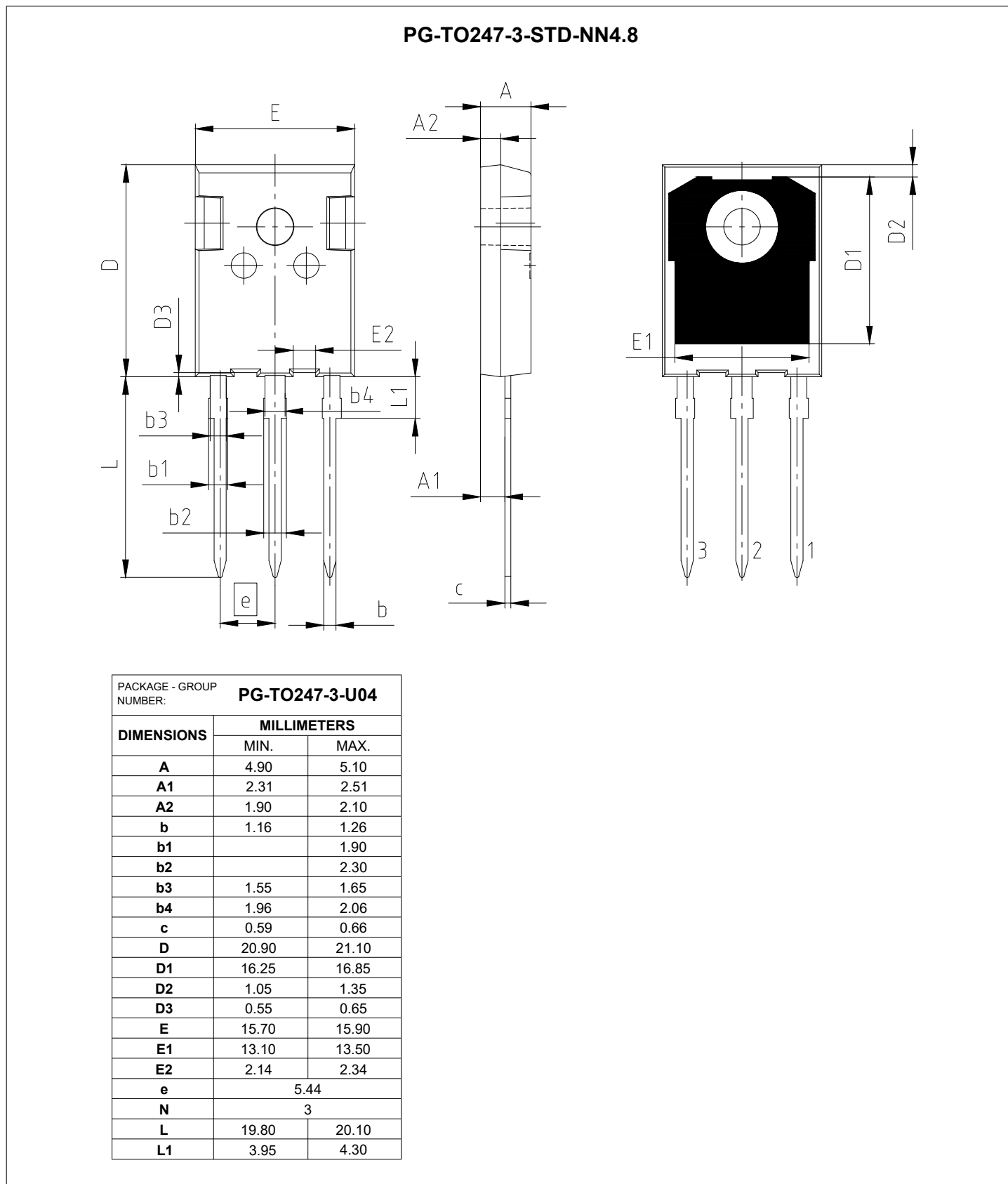

Figure 1

## 6 Testing conditions

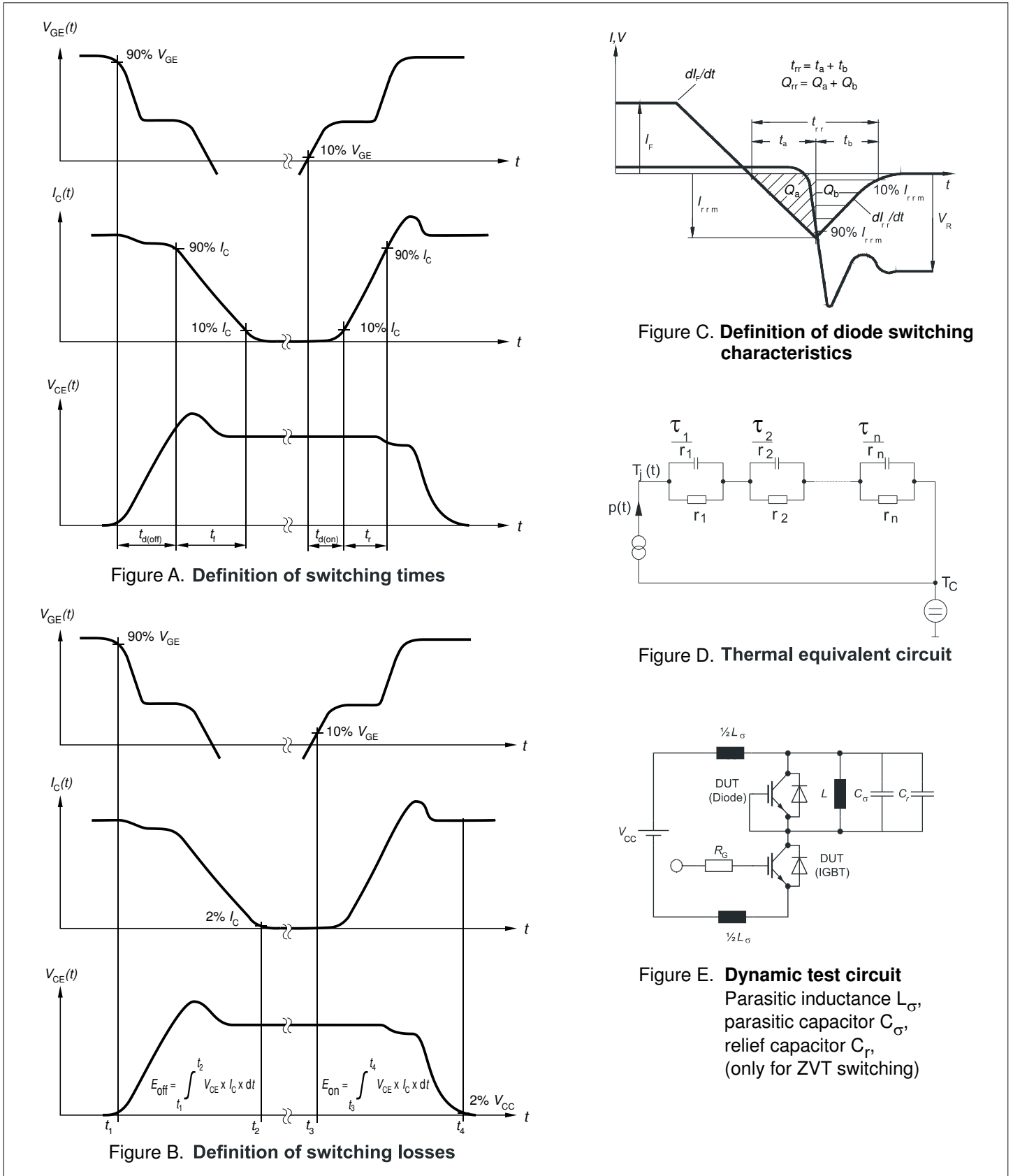

Figure 2

## Revision history

Document revision	Date of release	Description of changes
1.00	2021-05-21	Final datasheet
1.10	2022-12-06	Update of “DC collector current, limited by $T_{vjmax}$ ” in table “Maximum rated values”, for 25°C and 100°C Transient gate-emitter voltage $V_{GE}$ in table “Maximum rated values” of IGBT changed to $\pm 30V$ Update of diagram “Collector current as a function of case temperature”, $I_C = f(T_C)$ "Forward bias safe operating area" diagram renamed to “Reverse bias safe operating area” Correction of package outline dimensions Change package name to marketing name Editorial changes



## Trademarks

All referenced product or service names and trademarks are the property of their respective owners.

**Edition 2022-12-06**

**Published by**

**Infineon Technologies AG**

**81726 Munich, Germany**

**© 2022 Infineon Technologies AG**

**All Rights Reserved.**

**Do you have a question about any aspect of this document?**

**Email: [erratum@infineon.com](mailto:erratum@infineon.com)**

**Document reference**

**IFX-ABA918-002**

## Important notice

The information given in this document shall in no event be regarded as a guarantee of conditions or characteristics ("Beschaffheitsgarantie").

With respect to any examples, hints or any typical values stated herein and/or any information regarding the application of the product, Infineon Technologies hereby disclaims any and all warranties and liabilities of any kind, including without limitation warranties of non-infringement of intellectual property rights of any third party.

In addition, any information given in this document is subject to customer's compliance with its obligations stated in this document and any applicable legal requirements, norms and standards concerning customer's products and any use of the product of Infineon Technologies in customer's applications.

The data contained in this document is exclusively intended for technically trained staff. It is the responsibility of customer's technical departments to evaluate the suitability of the product for the intended application and the completeness of the product information given in this document with respect to such application.

Please note that this product is not qualified according to the AEC Q100 or AEC Q101 documents of the Automotive Electronics Council.

## Warnings

Due to technical requirements products may contain dangerous substances. For information on the types in question please contact your nearest Infineon Technologies office.

Except as otherwise explicitly approved by Infineon Technologies in a written document signed by authorized representatives of Infineon Technologies, Infineon Technologies' products may not be used in any applications where a failure of the product or any consequences of the use thereof can reasonably be expected to result in personal injury.

## X-ON Electronics

Largest Supplier of Electrical and Electronic Components

*Click to view similar products for [IGBT Transistors](#) category:*

*Click to view products by [Infineon](#) manufacturer:*

Other Similar products are found below :

[IRG4PC30W](#) [APT20GT60BRDQ1G](#) [STGWA25H120DF2](#) [APT30GS60BRDQ2G](#) [GT50JR22\(STA1ES\)](#) [TIG058E8-TL-H](#) [IDW40E65D2](#)  
[APT40GR120B2SCD10](#) [NGTB75N65FL2WAG](#) [NTE3320](#) [STGW80H65DFB-4](#) [IKFW50N65EH5XKSA1](#) [IMBG120R090M1HXTMA1](#)  
[GT30N135SRA,S1E](#) [IGW30N60TP](#) [IGW40N60TP](#) [IGW50N60TP](#) [IHW30N65R5](#) [IKFW40N60DH3E](#) [IKP15N65H5](#) [IKQ100N60T](#)  
[IKQ120N60T](#) [IKW75N60H3](#) [IKZ50N65NH5](#) [IKZ75N65NH5](#) [FGD3040G2-F085C](#) [FGH4L50T65SQD](#) [FGHL40T65MQDT](#)  
[FGHL50T65MQD](#) [FGHL50T65MQDTL4](#) [FGHL75T65LQDT](#) [FGHL75T65MQD](#) [FGHL75T65MQDT](#) [FGHL75T65MQDTL4](#)  
[FGY75T120SWD](#) [EL3120S1\(TA\)\(SAS\)-V](#) [CRG40T60AK3SD](#) [CRG15T120BNR3S](#) [KGF75N65KDF-U/H](#) [MBQ40T120FESTH](#)  
[AOB10B65M1](#) [CRG15T60A83L](#) [CRG40T120BK3SD](#) [CRG40T65AN5H](#) [RGTH60TS65GC11](#) [FGH60N60SMD\\_F085](#) [FGH75T65UPD](#)  
[FGY75N60SMD](#) [NGB8206ANSL3G](#) [IKW20N60H3FKSA1](#)