

CoolSiC™ 2000 V SiC Trench MOSFET : Silicon Carbide MOSFET with .XT interconnection technology

Features

- $V_{DS} = 2000\text{ V}$ at $T_{vj} = 25^\circ\text{C}$
- $I_{DCC} = 123\text{ A}$ at $T_c = 25^\circ\text{C}$
- $R_{DS(on)} = 12\text{ m}\Omega$ at $V_{GS} = 18\text{ V}$, $T_{vj} = 25^\circ\text{C}$
- Very low switching losses
- Benchmark gate threshold voltage, $V_{GS(th)} = 4.5\text{ V}$
- Robust body diode for hard commutation
- .XT interconnection technology for best-in-class thermal performance

Potential applications

- String inverter
- Solar power optimizer
- EV-Charging

Product validation

- Qualified for industrial applications according to the relevant tests of JEDEC47/20/22
- Please also note the application note AN2019-05 for power and thermal cycling

Description

- 1 – drain
- 2 – source
- 3 – Kelvin sense contact
- 4 – gate

Note: the source and sense pins are not exchangeable, their exchange might lead to malfunction (only for 4pin, TO263-7L)

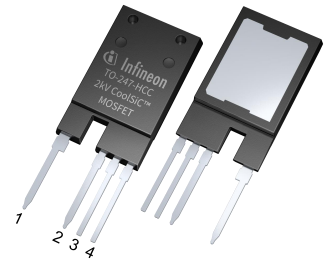

- Halogen-free
- Green
- Lead-free
- RoHS

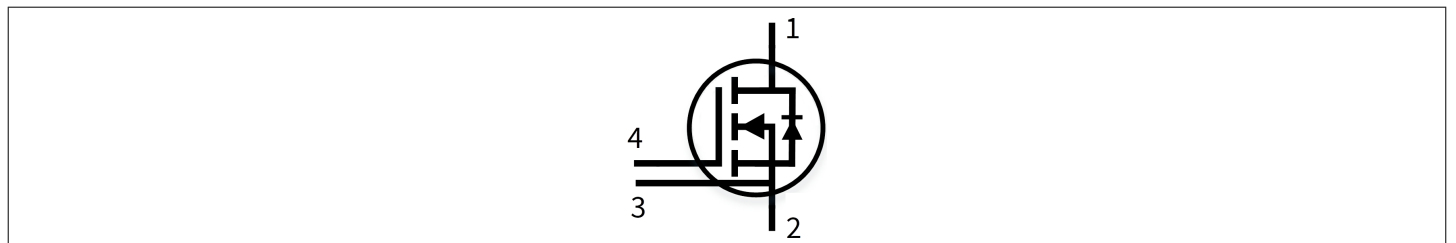

Type	Package	Marking
IMYH200R012M1H	PG-TO247-4-PLUS-NT14	20M1H012

Table of contents

	Description	1
	Features	1
	Potential applications	1
	Product validation	1
	Table of contents	2
1	Package	3
2	MOSFET	3
3	Body diode (MOSFET)	6
4	Characteristics diagrams	7
5	Package outlines	13
6	Testing conditions	14
	Revision history	15
	Disclaimer	16

1 Package

Table 1 Characteristic values

Parameter	Symbol	Note or test condition	Values			Unit
			Min.	Typ.	Max.	
Storage temperature	T_{stg}		-55		150	°C
Soldering temperature	T_{sold}	wave soldering 1.6 mm (0.063 in.) from case for 10 s			260	°C
Thermal resistance, junction-ambient	$R_{th(j-a)}$				62	K/W
MOSFET/body diode thermal resistance, junction-case	$R_{th(j-c)}$			0.12	0.16	K/W

2 MOSFET

Table 2 Maximum rated values

Parameter	Symbol	Note or test condition	Values	Unit	
Drain-source voltage	V_{DSS}	$T_{vj} \geq 25 \text{ °C}$	2000	V	
Continuous DC drain current for $R_{th(j-c,max)}$, limited by $T_{vj(max)}$	I_{DDC}	$V_{GS} = 18 \text{ V}$	$T_c = 25 \text{ °C}$	123	A
			$T_c = 100 \text{ °C}$	94	
Peak drain current, t_p limited by $T_{vj(max)}$	I_{DM}	$V_{GS} = 18 \text{ V}$	282	A	
Gate-source voltage, max. transient voltage ¹⁾	V_{GS}	$t_p \leq 0.5 \text{ }\mu\text{s}$, $D < 0.01$	-10/23	V	
Gate-source voltage, max. static voltage	V_{GS}		-7/20	V	
Power dissipation, limited by $T_{vj(max)}$	P_{tot}	$T_c = 25 \text{ °C}$	552	W	
		$T_c = 100 \text{ °C}$	319		

1) **Important note:** The selection of positive and negative gate-source voltages impacts the long-term behavior of the device. The design guidelines described in Application Note AN2018-09 must be considered to ensure sound operation of the device over the planned lifetime.

Table 3 Recommended values

Parameter	Symbol	Note or test condition	Values	Unit
Recommended turn-on gate voltage	$V_{GS(on)}$		15...18	V
Recommended turn-off gate voltage	$V_{GS(off)}$		-5...0	V

Table 4 Characteristic values

Parameter	Symbol	Note or test condition	Values			Unit	
			Min.	Typ.	Max.		
Drain-source on-state resistance	$R_{DS(on)}$	$I_D = 60\text{ A}$	$T_{vj} = 25\text{ °C}$, $V_{GS(on)} = 18\text{ V}$		12	16.5	mΩ
			$T_{vj} = 100\text{ °C}$, $V_{GS(on)} = 18\text{ V}$		20		
			$T_{vj} = 175\text{ °C}$, $V_{GS(on)} = 18\text{ V}$		36		
			$T_{vj} = 25\text{ °C}$, $V_{GS(on)} = 15\text{ V}$		13	18	
Gate-source threshold voltage	$V_{GS(th)}$	$I_D = 48\text{ mA}$, $V_{DS} = V_{GS}$ (tested after 1 ms pulse at $V_{GS} = 20\text{ V}$)	$T_{vj} = 25\text{ °C}$	3.5	4.5	5.5	V
			$T_{vj} = 175\text{ °C}$		3.6		
Zero gate-voltage drain current	I_{DSS}	$V_{DS} = 2000\text{ V}$, $V_{GS} = 0\text{ V}$	$T_{vj} = 25\text{ °C}$			800	μA
			$T_{vj} = 175\text{ °C}$		10		
Gate leakage current	I_{GSS}	$V_{DS} = 0\text{ V}$	$V_{GS} = 23\text{ V}$			100	nA
			$V_{GS} = -10\text{ V}$			-100	
Forward transconductance	g_{fs}	$I_D = 60\text{ A}$, $V_{DS} = 20\text{ V}$			30		S
Internal gate resistance	$R_{G,int}$	$f = 100\text{ kHz}$, $V_{AC} = 25\text{ mV}$			3		Ω
Input capacitance	C_{iss}	$V_{DD} = 1200\text{ V}$, $V_{GS} = 0\text{ V}$, $f = 100\text{ kHz}$, $V_{AC} = 25\text{ mV}$			9700		pF
Output capacitance	C_{oss}	$V_{DD} = 1200\text{ V}$, $V_{GS} = 0\text{ V}$, $f = 100\text{ kHz}$, $V_{AC} = 25\text{ mV}$			322		pF
Reverse transfer capacitance	C_{rss}	$V_{DD} = 1200\text{ V}$, $V_{GS} = 0\text{ V}$, $f = 100\text{ kHz}$, $V_{AC} = 25\text{ mV}$			22		pF
C_{oss} stored energy	E_{oss}	$V_{DD} = 1200\text{ V}$, $V_{GS} = 0\text{ V}$, $f = 100\text{ kHz}$, $V_{AC} = 25\text{ mV}$			216		μJ
Total gate charge	Q_G	$V_{DD} = 1200\text{ V}$, $I_D = 60\text{ A}$, $V_{GS} = -2/18\text{ V}$, turn-on pulse			246		nC
Plateau gate charge	$Q_{GS(pl)}$	$V_{DD} = 1200\text{ V}$, $I_D = 60\text{ A}$, $V_{GS} = -2/18\text{ V}$, turn-on pulse			66		nC
Gate-to-drain charge	Q_{GD}	$V_{DD} = 1200\text{ V}$, $I_D = 60\text{ A}$, $V_{GS} = -2/18\text{ V}$, turn-on pulse			44		nC
Turn-on delay time	$t_{d(on)}$	$V_{DD} = 1200\text{ V}$, $I_D = 60\text{ A}$, $V_{GS} = -2/18\text{ V}$, $R_{GS(on)} = 2\text{ Ω}$, $R_{GS(off)} = 2\text{ Ω}$, $L_\sigma = 15\text{ nH}$, diode: body diode at $V_{GS} = -2\text{ V}$	$T_{vj} = 25\text{ °C}$		16		ns
			$T_{vj} = 175\text{ °C}$		21		

(table continues...)

Table 4 (continued) Characteristic values

Parameter	Symbol	Note or test condition	Values			Unit
			Min.	Typ.	Max.	
Rise time	t_r	$V_{DD} = 1200\text{ V}, I_D = 60\text{ A},$ $V_{GS} = -2/18\text{ V},$ $R_{GS(on)} = 2\ \Omega,$ $R_{GS(off)} = 2\ \Omega, L_\sigma = 15\text{ nH},$ diode: body diode at $V_{GS} = -2\text{ V}$	$T_{vj} = 25\text{ }^\circ\text{C}$		13	ns
			$T_{vj} = 175\text{ }^\circ\text{C}$		19	
Turn-off delay time	$t_{d(off)}$	$V_{DD} = 1200\text{ V}, I_D = 60\text{ A},$ $V_{GS} = -2/18\text{ V},$ $R_{GS(on)} = 2\ \Omega,$ $R_{GS(off)} = 2\ \Omega, L_\sigma = 15\text{ nH},$ diode: body diode at $V_{GS} = -2\text{ V}$	$T_{vj} = 25\text{ }^\circ\text{C}$		50	ns
			$T_{vj} = 175\text{ }^\circ\text{C}$		77	
Fall time	t_f	$V_{DD} = 1200\text{ V}, I_D = 60\text{ A},$ $V_{GS} = -2/18\text{ V},$ $R_{GS(on)} = 2\ \Omega,$ $R_{GS(off)} = 2\ \Omega, L_\sigma = 15\text{ nH},$ diode: body diode at $V_{GS} = -2\text{ V}$	$T_{vj} = 25\text{ }^\circ\text{C}$		24	ns
			$T_{vj} = 175\text{ }^\circ\text{C}$		27	
Turn-on energy	E_{on}	$V_{DD} = 1200\text{ V}, I_D = 60\text{ A},$ $V_{GS} = -2/18\text{ V},$ $R_{GS(on)} = 2\ \Omega,$ $R_{GS(off)} = 2\ \Omega, L_\sigma = 15\text{ nH},$ diode: body diode at $V_{GS} = -2\text{ V}$	$T_{vj} = 25\text{ }^\circ\text{C}$		2400	μJ
			$T_{vj} = 175\text{ }^\circ\text{C}$		3800	
Turn-off energy	E_{off}	$V_{DD} = 1200\text{ V}, I_D = 60\text{ A},$ $V_{GS} = -2/18\text{ V},$ $R_{GS(on)} = 2\ \Omega,$ $R_{GS(off)} = 2\ \Omega, L_\sigma = 15\text{ nH},$ diode: body diode at $V_{GS} = -2\text{ V}$	$T_{vj} = 25\text{ }^\circ\text{C}$		960	μJ
			$T_{vj} = 175\text{ }^\circ\text{C}$		1200	
Total switching energy	E_{tot}	$V_{DD} = 1200\text{ V}, I_D = 60\text{ A},$ $V_{GS} = -2/18\text{ V},$ $R_{GS(on)} = 2\ \Omega,$ $R_{GS(off)} = 2\ \Omega, L_\sigma = 15\text{ nH},$ diode: body diode at $V_{GS} = -2\text{ V}$	$T_{vj} = 25\text{ }^\circ\text{C}$		4280	μJ
			$T_{vj} = 175\text{ }^\circ\text{C}$		6835	
Virtual junction temperature	T_{vj}			-55	175	$^\circ\text{C}$

Note: The chip technology was characterized up to 100 kV/ μs . The measured dV/dt was limited by measurement test setup and package.

Dynamic test circuit see Fig. F.

3 Body diode (MOSFET)

Table 5 Maximum rated values

Parameter	Symbol	Note or test condition	Values	Unit	
Drain-source voltage	V_{DSS}	$T_{vj} \geq 25\text{ °C}$	2000	V	
Continuous reverse drain current for $R_{th(j-c,max)}$, limited by $T_{vj(max)}$	I_{SDC}	$V_{GS} = 0\text{ V}$	$T_c = 25\text{ °C}$	123	A
			$T_c = 100\text{ °C}$	94	
Peak reverse drain current, t_p limited by $T_{vj(max)}$	I_{SM}	$V_{GS} = 0\text{ V}$	256	A	

Table 6 Characteristic values

Parameter	Symbol	Note or test condition	Values			Unit
			Min.	Typ.	Max.	
Drain-source reverse voltage	V_{SD}	$I_{SD} = 60\text{ A}, V_{GS} = 0\text{ V}$	$T_{vj} = 25\text{ °C}$	3.4	5.5	V
			$T_{vj} = 100\text{ °C}$	3.3		
			$T_{vj} = 175\text{ °C}$	3.2		
MOSFET forward recovery charge	Q_{fr}	$V_{DD} = 1200\text{ V}, I_{SD} = 60\text{ A}, V_{GS} = -2\text{ V}, R_{GS(on)} = 2\text{ }\Omega, Q_{fr}$ includes also Q_C	$T_{vj} = 25\text{ °C}$	2000		nC
			$T_{vj} = 175\text{ °C}$	3950		
MOSFET peak forward recovery current	I_{frm}	$V_{DD} = 1200\text{ V}, I_{SD} = 60\text{ A}, V_{GS} = -2\text{ V}, di_{SD}/dt = 3000\text{ A}/\mu\text{s}, Q_{fr}$ includes also Q_C	$T_{vj} = 25\text{ °C}$	54		A
			$T_{vj} = 175\text{ °C}$	63		
MOSFET forward recovery energy	E_{fr}	$V_{DD} = 1200\text{ V}, I_{SD} = 60\text{ A}, V_{GS} = -2\text{ V}, R_{GS(on)} = 2\text{ }\Omega, Q_{fr}$ includes also Q_C	$T_{vj} = 25\text{ °C}$	920		μJ
			$T_{vj} = 175\text{ °C}$	1835		
Virtual junction temperature	T_{vj}		-55		175	$^{\circ}\text{C}$

4 Characteristics diagrams

Reverse bias safe operating area (RBSOA)

$$I_{DS} = f(V_{DS})$$

$$T_{vj} \leq 175\text{ °C}, V_{GS} = 0/18\text{ V}, T_c = 25\text{ °C}$$

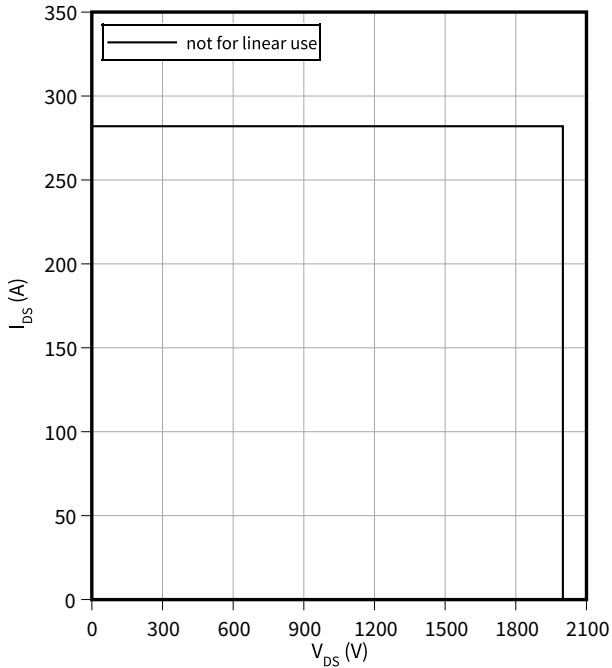

Power dissipation as a function of case temperature limited by bond wire

$$P_{tot} = f(T_c)$$

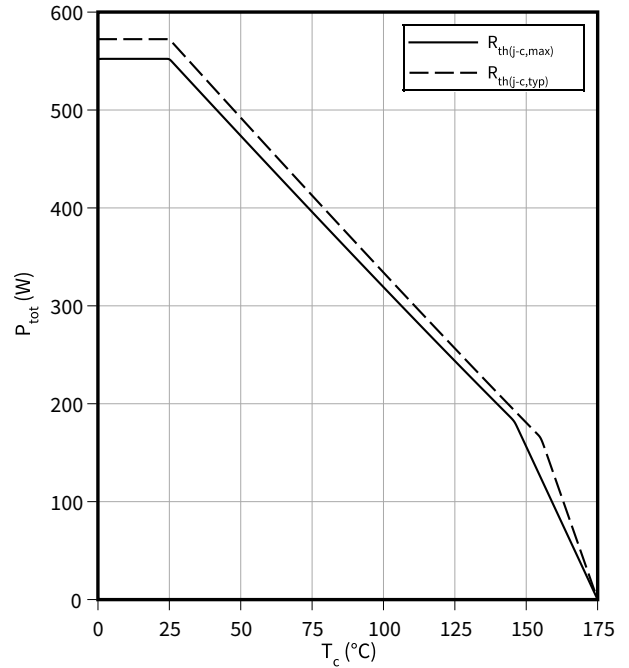

Maximum DC drain to source current as a function of case temperature limited by bond wire

$$I_{DS} = f(T_c)$$

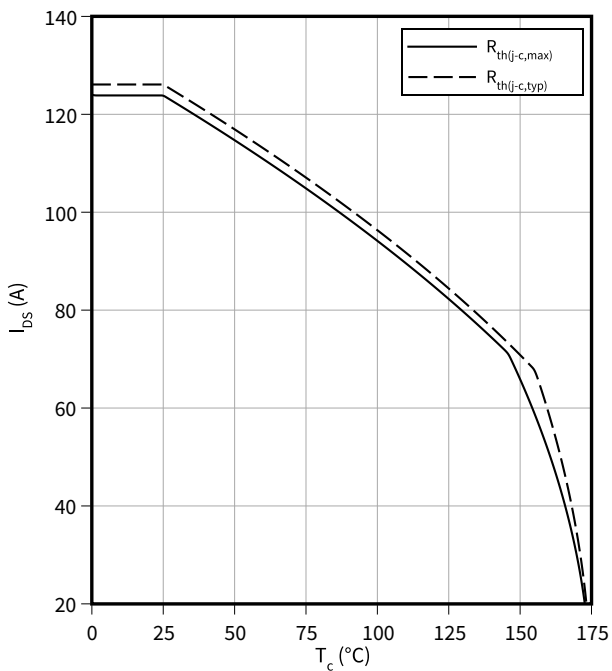

Maximum source to drain current as a function of case temperature limited by bond wire

$$I_{SD} = f(T_c)$$

$$V_{GS} = 0\text{ V}$$

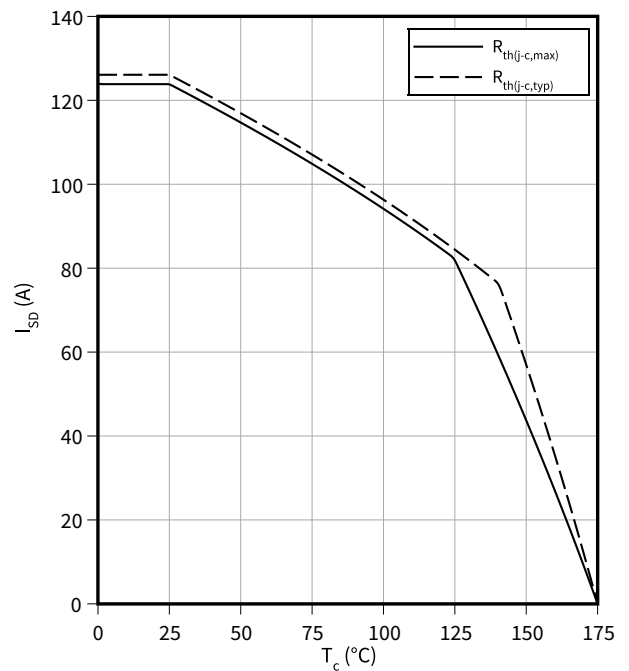

4 Characteristics diagrams

Typical transfer characteristic

$I_{DS} = f(V_{GS})$
 $V_{DS} = 20\text{ V}$, $t_p = 20\ \mu\text{s}$

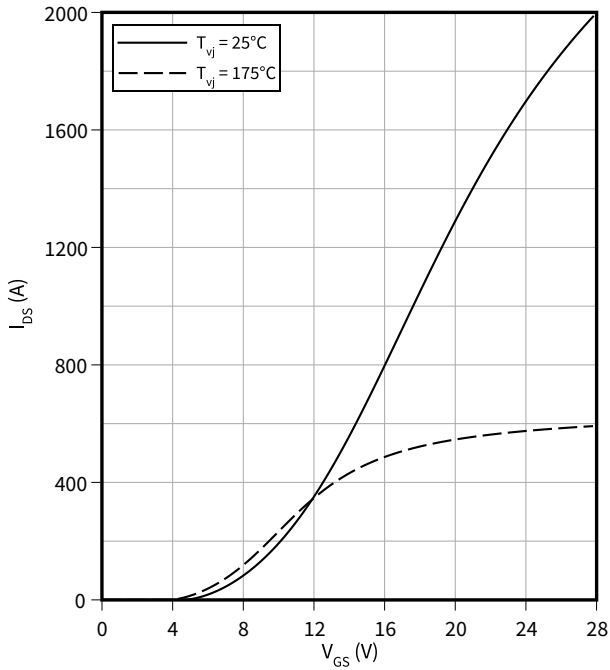

Typical gate-source threshold voltage as a function of junction temperature

$V_{GS(th)} = f(T_{vj})$
 $I_D = 48\text{ mA}$

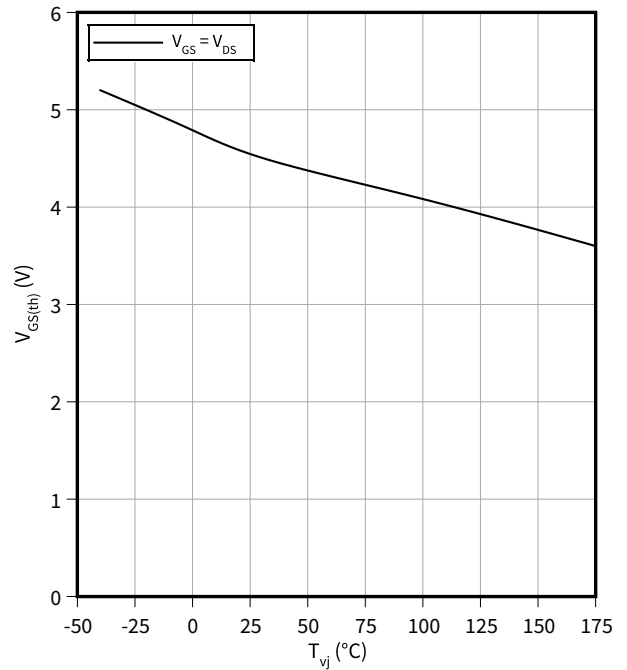

Typical output characteristic, V_{GS} as parameter

$I_{DS} = f(V_{DS})$
 $T_{vj} = 25\ ^\circ\text{C}$, $t_p = 20\ \mu\text{s}$

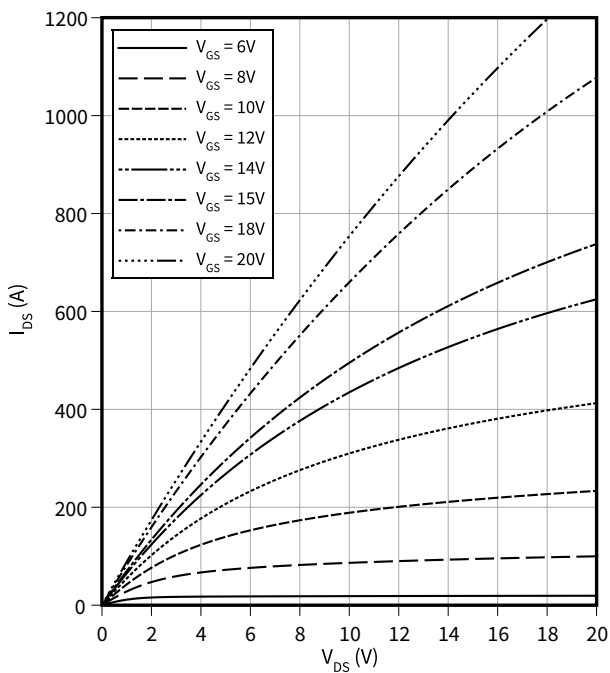

Typical output characteristic, V_{GS} as parameter

$I_{DS} = f(V_{DS})$
 $T_{vj} = 175\ ^\circ\text{C}$, $t_p = 20\ \mu\text{s}$

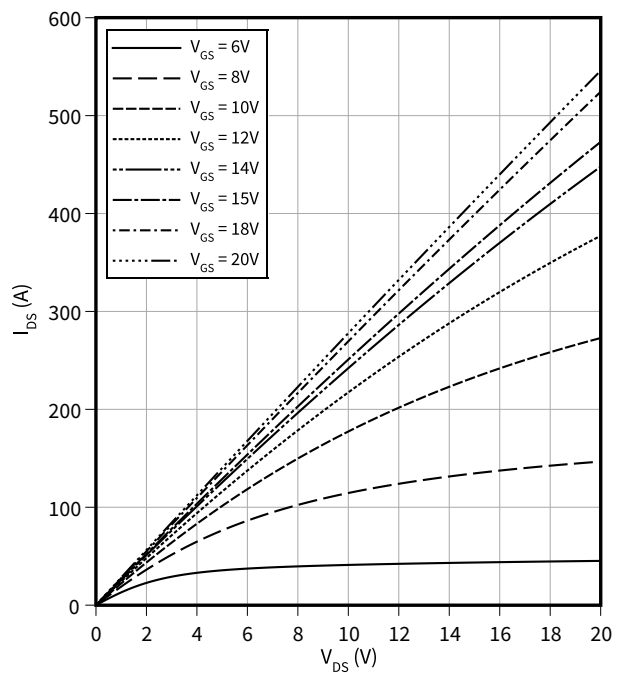

4 Characteristics diagrams

Typical on-state resistance as a function of junction temperature

$R_{DS(on)} = f(T_{vj})$
 $I_D = 60 \text{ A}$

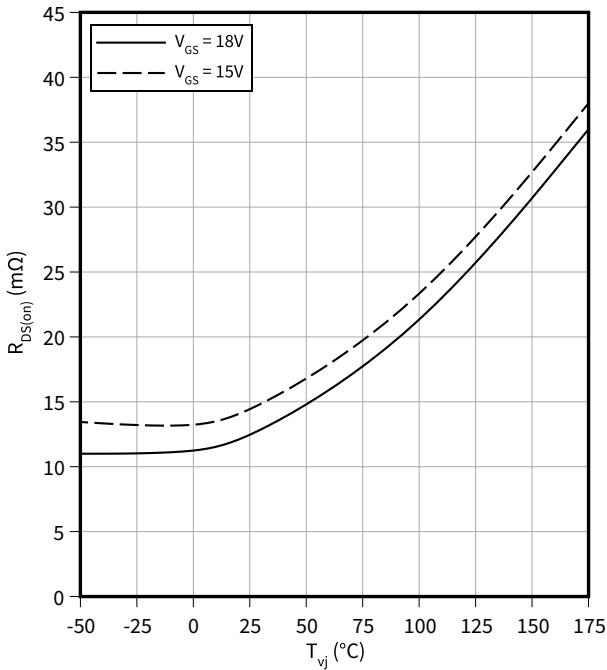

Typical gate charge

$V_{GS} = f(Q_G)$
 $I_D = 60 \text{ A}, V_{DS} = 1200 \text{ V}$

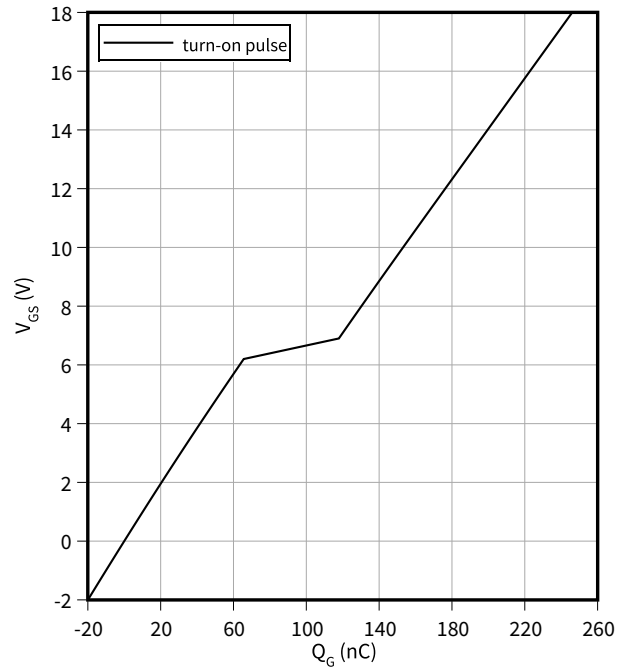

Typical capacitance as a function of drain-source voltage

$C = f(V_{DS})$
 $f = 100 \text{ kHz}, V_{GS} = 0 \text{ V}$

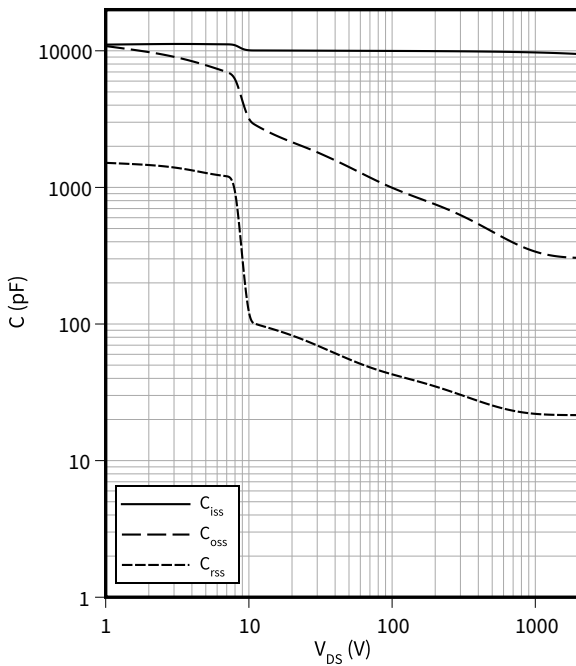

Typical reverse drain voltage as function of junction temperature

$V_{SD} = f(T_{vj})$
 $I_{SD} = 60 \text{ A}, V_{GS} = 0 \text{ V}$

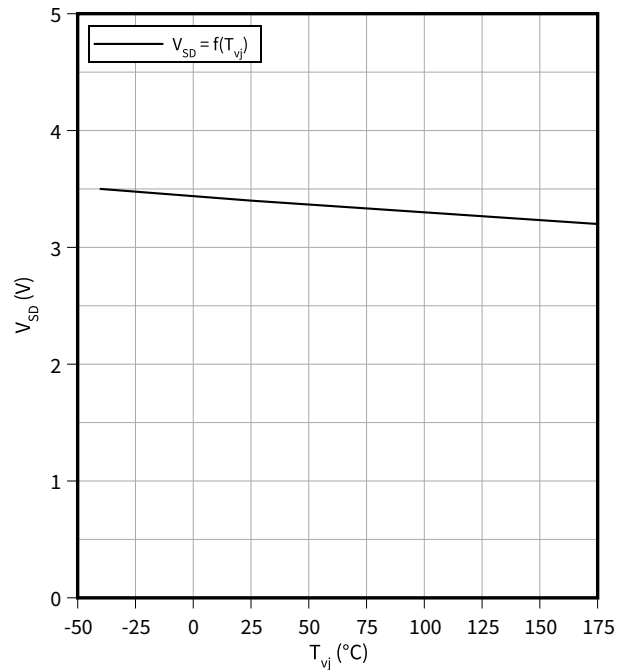

4 Characteristics diagrams

Typical reverse drain current as function of reverse drain voltage, V_{GS} as parameter

$I_{SD} = f(V_{SD})$
 $T_{vj} = 25\text{ °C}$, $t_p = 20\text{ }\mu\text{s}$

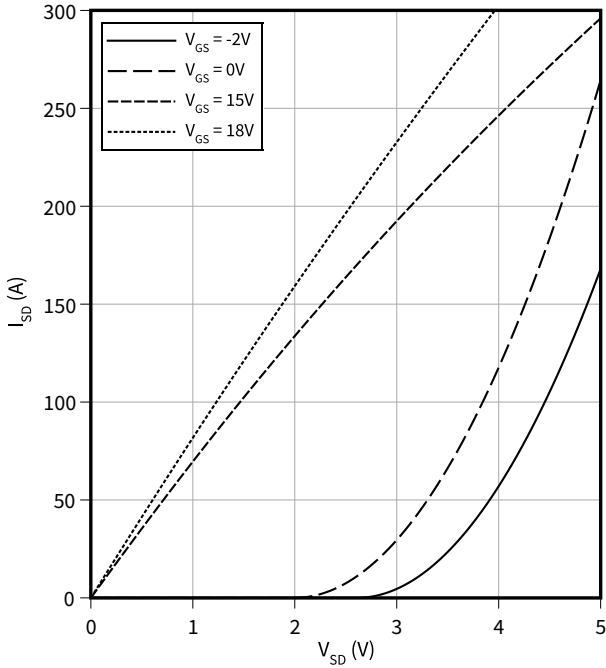

Typical reverse drain current as function of reverse drain voltage, V_{GS} as parameter

$I_{SD} = f(V_{SD})$
 $T_{vj} = 175\text{ °C}$, $t_p = 20\text{ }\mu\text{s}$

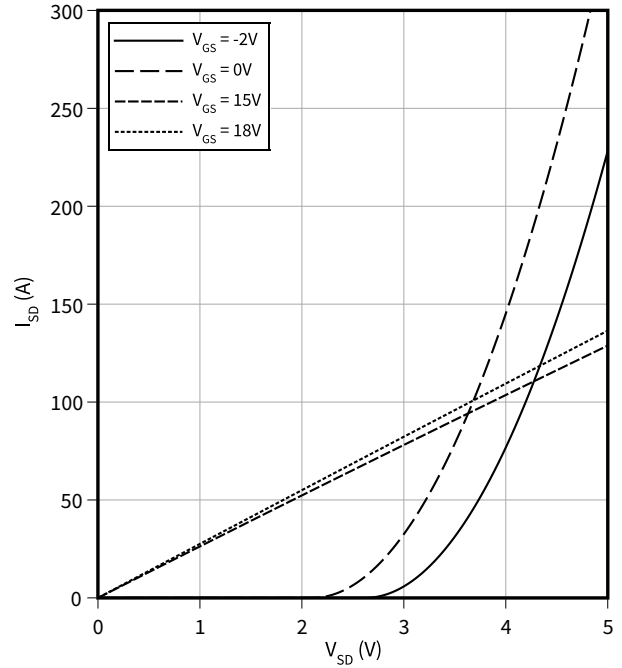

Typical switching energy as a function of junction temperature, test circuit in Fig. F, 2nd device own body diode: $V_{GS} = -2\text{ V}$

$E = f(T_{vj})$
 $V_{GS} = -2/18\text{ V}$, $I_D = 60\text{ A}$, $R_{G,ext} = 2\text{ }\Omega$, $V_{DD} = 1200\text{ V}$

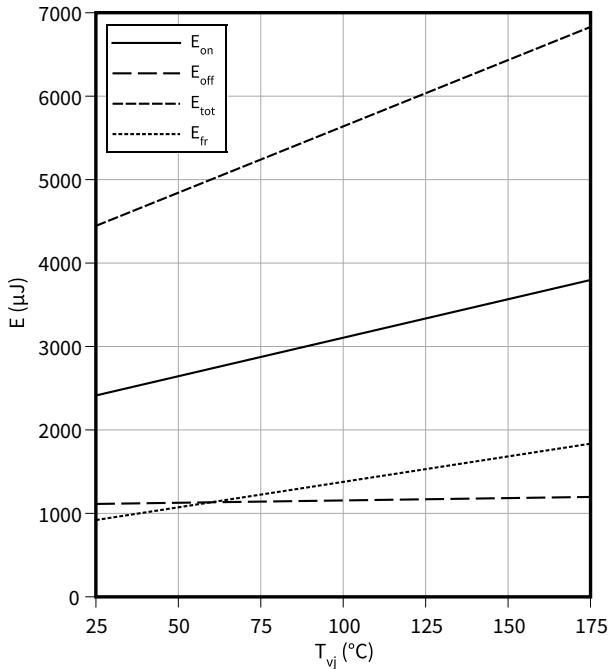

Typical switching energy as a function of drain current, test circuit in Fig. F, 2nd device own body diode: $V_{GS} = -2\text{ V}$

$E = f(I_D)$
 $V_{GS} = -2/18\text{ V}$, $T_{vj} = 175\text{ °C}$, $R_{G,ext} = 2\text{ }\Omega$, $V_{DD} = 1200\text{ V}$

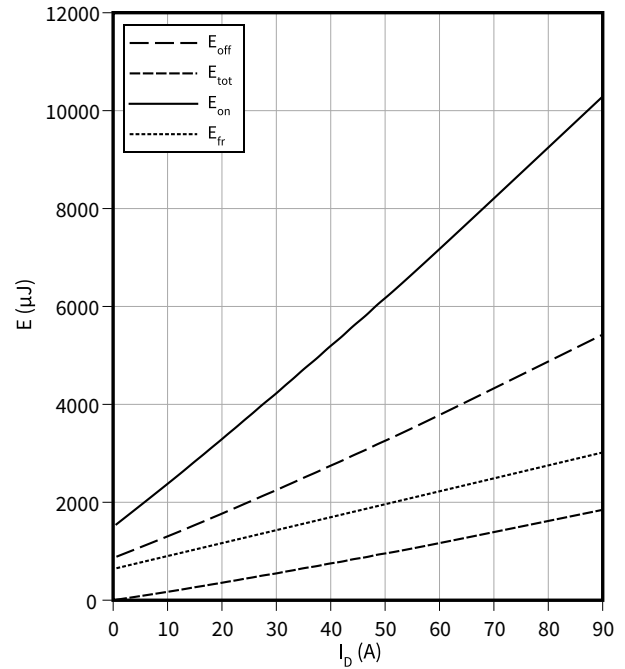

4 Characteristics diagrams

Typical switching energy losses as a function of gate resistance, test circuit in Fig. F, 2nd device own body diode: $V_{GS} = -2\text{ V}$

$E = f(R_{G,ext})$
 $V_{GS} = -2/18\text{ V}$, $I_D = 60\text{ A}$, $T_{vj} = 175\text{ °C}$, $V_{DD} = 1200\text{ V}$

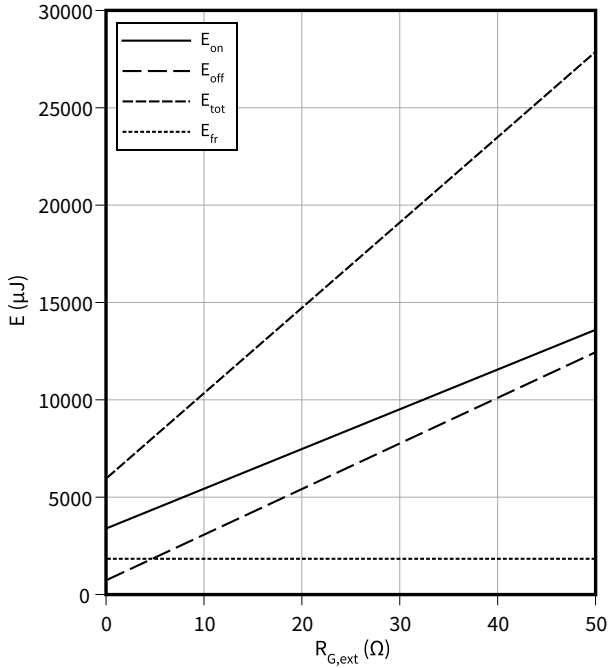

Typical switching times as a function of gate resistance, test circuit in Fig. F, 2nd device own body diode: $V_{GS} = -2\text{ V}$

$t = f(R_{G,ext})$
 $V_{GS} = -2/18\text{ V}$, $I_D = 60\text{ A}$, $T_{vj} = 175\text{ °C}$, $V_{DD} = 1200\text{ V}$

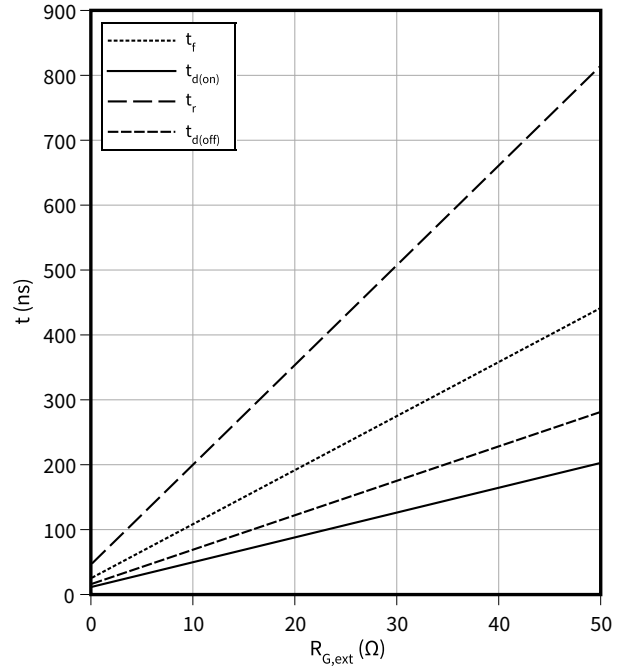

Typical reverse recovery charge as a function of reverse drain current slope, test circuit in Fig. F, 2nd device own body diode: $V_{GS} = -2\text{ V}$

$Q_{fr} = f(di_{SD}/dt)$
 $V_{GS} = -2/18\text{ V}$, $I_{SD} = 60\text{ A}$, $V_{DD} = 1200\text{ V}$

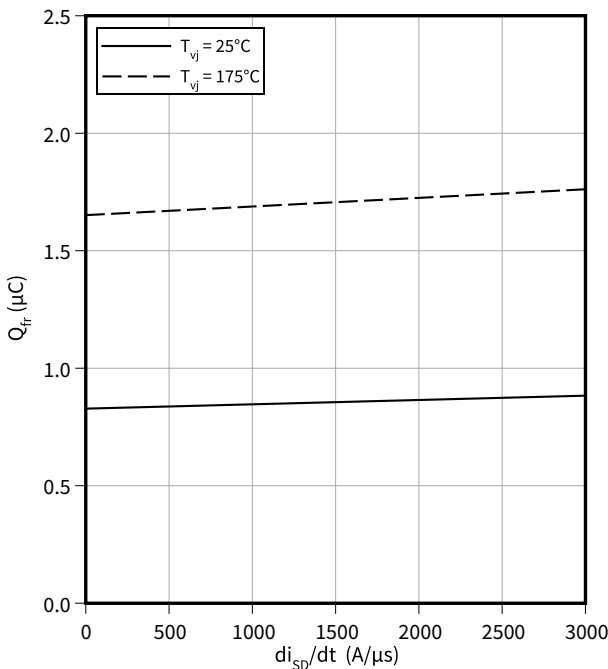

Typical reverse recovery current as a function of reverse drain current slope, test circuit in Fig. F, 2nd device own body diode: $V_{GS} = -2\text{ V}$

$I_{frm} = f(di_{SD}/dt)$
 $V_{GS} = -2/18\text{ V}$, $I_{SD} = 60\text{ A}$, $V_{DD} = 1200\text{ V}$

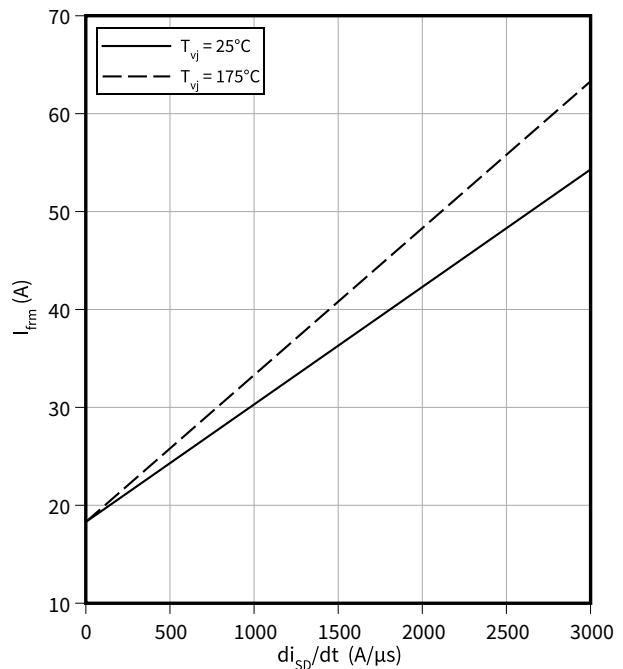

4 Characteristics diagrams

Typical switching energy losses as a function of dead time / blanking time, test circuit in Fig. F, 2nd device own body diode: $V_{GS} = -5\text{ V}$

$$E = f(t_{\text{dead}})$$

$I_D = 60\text{ A}$, $T_{vj} = 175\text{ °C}$, $R_{G,\text{ext}} = 2\ \Omega$, $V_{DD} = 1200\text{ V}$

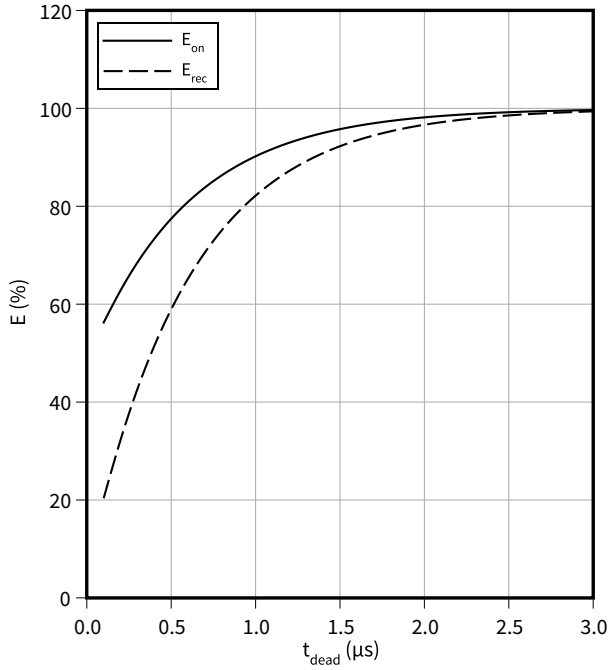

Max. transient thermal impedance (MOSFET/diode)

$$Z_{\text{th}(j-c),\text{max}} = f(t_p)$$

$$D = t_p/T$$

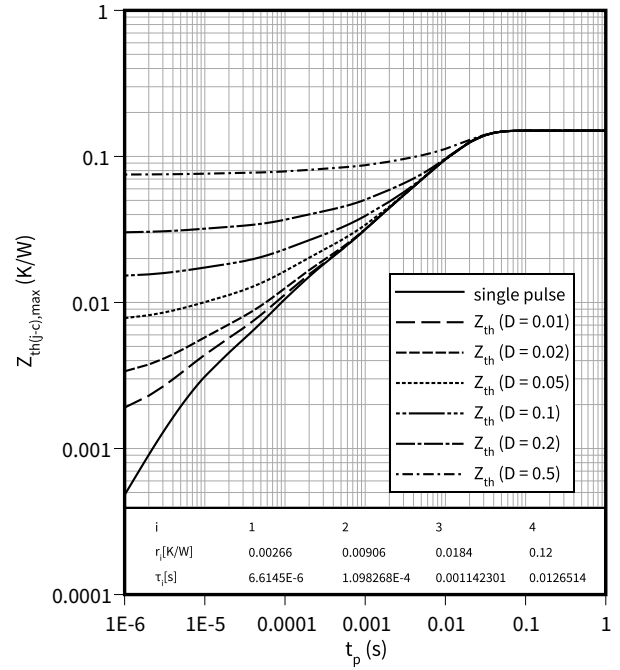

5 Package outlines

PG-T0247-4-PLUS-NT14

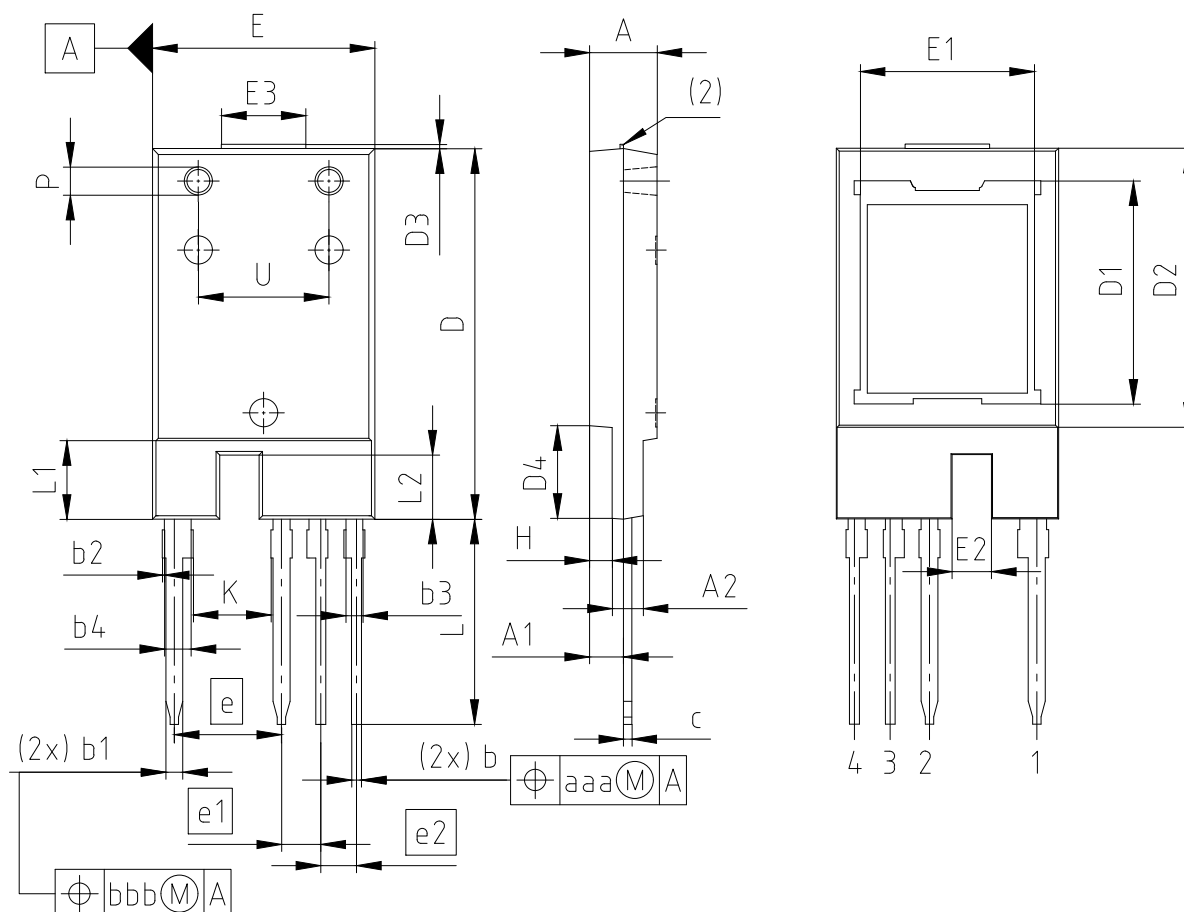

NOTES:

- (1) ALL METAL SURFACES TIN PLATED EXCEPT AREA OF CUT
- (2) MOLD GATE PROTRUSION AFTER DEGATING

PACKAGE - GROUP NUMBER: **PG-T0247-4-U04**

DIMENSIONS	MILLIMETERS		DIMENSIONS	MILLIMETERS	
	MIN.	MAX.		MIN.	MAX.
A	4.65	4.95	E1	12.00	12.80
A1	2.16	2.66	E2	2.60	3.00
A2	2.00	2.40	E3	5.00	7.00
b	0.60	0.80	e	7.62	
b1	1.10	1.30	e1	2.79	
b2	---	0.15	e2	2.54	
b3	1.10	1.30	H	1.51	1.71
b4	1.70	2.10	K	5.50	---
c	0.50	0.70	N	4	
D	26.00	26.70	L	14.30	14.90
D1	15.50	16.30	L1	5.40	5.70
D2	19.40	20.20	L2	5.40	5.70
D3	---	0.50	ØP	1.75	2.25
D4	6.35	6.65	U	9.00	9.50
E	15.60	16.00	aaa	0.25	
			bbb	0.25	

Figure 1

6 Testing conditions

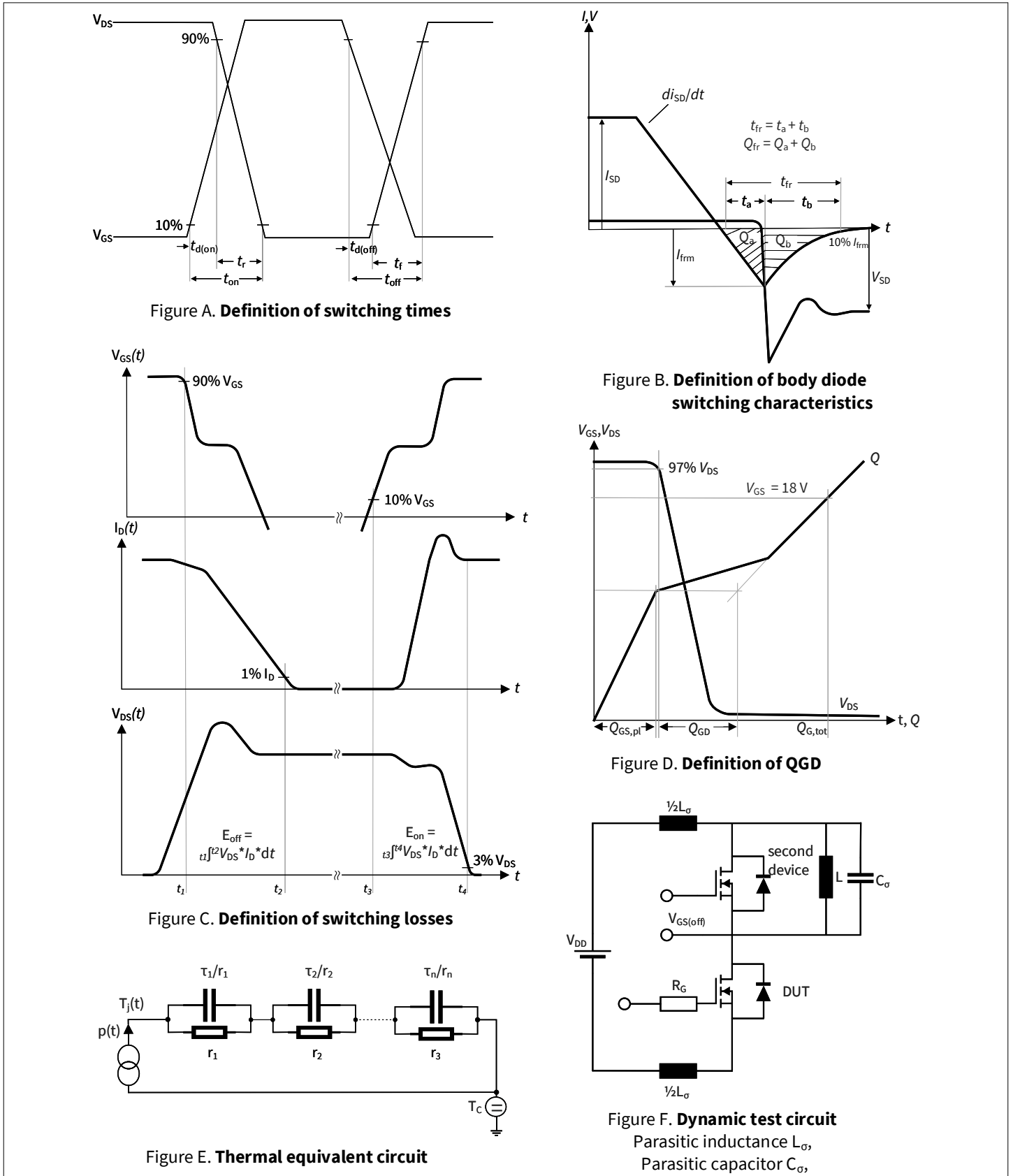

Figure 2

Revision history

Document revision	Date of release	Description of changes
0.10	2022-03-08	Preliminary datasheet
1.00	2022-10-04	Final datasheet
1.01	2022-10-06	Editorial changes
1.10	2023-01-16	Change of picture on page 1 Change of product outline drawing on page 13 Editorial changes

Trademarks

All referenced product or service names and trademarks are the property of their respective owners.

Edition 2023-01-16

Published by

Infineon Technologies AG

81726 Munich, Germany

© 2023 Infineon Technologies AG

All Rights Reserved.

Do you have a question about any aspect of this document?

Email: erratum@infineon.com

Document reference

IFX-ABD142-004

Important notice

The information given in this document shall in no event be regarded as a guarantee of conditions or characteristics ("Beschaffheitsgarantie").

With respect to any examples, hints or any typical values stated herein and/or any information regarding the application of the product, Infineon Technologies hereby disclaims any and all warranties and liabilities of any kind, including without limitation warranties of non-infringement of intellectual property rights of any third party.

In addition, any information given in this document is subject to customer's compliance with its obligations stated in this document and any applicable legal requirements, norms and standards concerning customer's products and any use of the product of Infineon Technologies in customer's applications.

The data contained in this document is exclusively intended for technically trained staff. It is the responsibility of customer's technical departments to evaluate the suitability of the product for the intended application and the completeness of the product information given in this document with respect to such application.

Please note that this product is not qualified according to the AEC Q100 or AEC Q101 documents of the Automotive Electronics Council.

Warnings

Due to technical requirements products may contain dangerous substances. For information on the types in question please contact your nearest Infineon Technologies office.

Except as otherwise explicitly approved by Infineon Technologies in a written document signed by authorized representatives of Infineon Technologies, Infineon Technologies' products may not be used in any applications where a failure of the product or any consequences of the use thereof can reasonably be expected to result in personal injury.

X-ON Electronics

Largest Supplier of Electrical and Electronic Components

Click to view similar products for [SiC MOSFETs](#) category:

Click to view products by [Infineon](#) manufacturer:

Other Similar products are found below :

[NTC040N120SC1](#) [HC3M001K170J](#) [IMBG65R048M1HXTMA1](#) [IMW120R045M1](#) [SCT3080ALGC11](#) [C3M0120100K](#) [C2M1000170J](#)
[C3M0120090J](#) [C3M0065090J](#) [C3M0280090J](#) [SCT2750NYTB](#) [SCT2H12NYTB](#) [C3M0021120D](#) [C3M0016120K](#) [C3M0045065D](#)
[C3M0045065K](#) [E3M0120090J](#) [C3M0065090J-TR](#) [C3M0120100J](#) [C3M0075120J](#) [DMWS120H100SM4](#) [DMWSH120H28SM4](#)
[DMWSH120H90SM4](#) [DMWSH120H90SM4Q](#) [DMWSH120H28SM4Q](#) [DMWSH120H90SCT7Q](#) [DMWSH120H28SM3](#)
[DMWSH120H43SM3](#) [DMWSH120H90SM3](#) [DMWSH120H28SM3Q](#) [DMWSH120H90SM3Q](#) [DIF120SIC053-AQ](#) [DIW120SIC059-AQ](#)
[G2R1000MT17D](#) [G3R60MT07K](#) [G2R50MT33K](#) [G3R12MT12K](#) [G3R160MT12D](#) [G3R160MT12J-TR](#) [G3R160MT17D](#) [G3R160MT17J-TR](#)
[G3R20MT12K](#) [G3R20MT12N](#) [G3R20MT17K](#) [G3R20MT17N](#) [G3R30MT12J-TR](#) [G3R30MT12K](#) [G3R350MT12D](#) [G3R40MT12D](#)
[G3R40MT12J](#)