

MOSFET

950V CoolMOS™ PFD7 SJ Power Device

The latest 950V CoolMOS™ PFD7 series sets a new benchmark in the super junction (SJ) technologies. This technology is designed to address Lighting and Industrial SMPS applications by combining best-in-class performance with state-of-the-art ease of use. Compared to the CoolMOS™ P7 families, the PFD7 offers an integrated ultra-fast body diode enabling usage in resonant topologies with markets lowest reverse recovery charge (Q_{rr}).

Features

- Integrated ultra-fast body diode
- Best-in-class reverse recovery charge Q_{rr}
- Best-in-class FOM R_{DS(on)} * E_{oss}, reduced Q_g, C_{iss}, and C_{oss}
- Best-in-class V_{(GS)th} of 3V and smallest V_{(GS)th} variation of ±0.5V
- Integrated fast body diode
- Best-in-class CoolMOS™ quality and reliability
- Fully optimized portfolio
- Best-in-class R_{DS(on)} in THD and SMD packages
- ESD protection min. Class 2 (HBM)

Benefits

- Excellent hard commutation robustness enabling usage in resonant topologies
- Extra safety margin for designs with increased bus voltage
- Enabling increased power density solutions
- Improved full load efficiency in industrial SMPS applications
- Price competitiveness over previous CoolMOS™ families
- Improved production yield by reducing ESD related failures

Potential applications

- Suitable for hard & soft switching topologies
- Optimized for usage in LLC and ZVS topologies
- PFC & LLC applications in Lighting and Industrial SMPS

Product validation

Fully qualified according to JEDEC for Industrial Applications

Table 1 Key Performance Parameters

Parameter	Value	Unit
V _{DS} @ T _j = 25 °C	950	V
R _{DS(on),max}	130	mΩ
Q _{g,typ}	141	nC
I _D	13.9	A
E _{oss} @ 500V	9.5	μJ
Body diode di _F /dt	1300	A/μs
Q _{oss} @ 500V	0.33	μC

Type / Ordering Code	Package	Marking	Related Links
IPA95R130PFD7	PG-TO220 FullPAK	95R130D7	see Appendix A

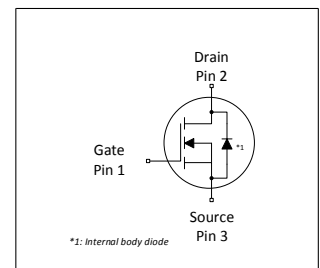

RoHS

Table of Contents

Description	1
Maximum ratings	3
Thermal characteristics	4
Electrical characteristics	5
Electrical characteristics diagrams	7
Test Circuits	11
Package Outlines	12
Appendix A	13
Revision History	14
Trademarks	14
Disclaimer	14

1 Maximum ratings

at $T_j = 25^\circ\text{C}$, unless otherwise specified

Table 2 Maximum ratings

Parameter	Symbol	Values			Unit	Note / Test Condition
		Min.	Typ.	Max.		
Continuous drain current ¹⁾	I_D	-	-	13.9 8.7	A	$T_C=25^\circ\text{C}$ $T_C=100^\circ\text{C}$
Pulsed drain current ²⁾	$I_{D,pulse}$	-	-	150	A	$T_C=25^\circ\text{C}$
Avalanche energy, single pulse	E_{AS}	-	-	100	mJ	$I_D=3.8\text{A}$; $V_{DD}=50\text{V}$; see table 10
Avalanche energy, repetitive	E_{AR}	-	-	0.77	mJ	$I_D=3.8\text{A}$; $V_{DD}=50\text{V}$; see table 10
Avalanche current, single pulse	I_{AS}	-	-	3.8	A	-
MOSFET dv/dt ruggedness	dv/dt	-	-	120	V/ns	$V_{DS}=0\dots400\text{V}$
Gate source voltage (static)	V_{GS}	-20	-	20	V	static;
Gate source voltage (dynamic)	V_{GS}	-30	-	30	V	AC ($f>1\text{ Hz}$)
Power dissipation	P_{tot}	-	-	33	W	$T_C=25^\circ\text{C}$
Storage temperature	T_{stg}	-55	-	150	$^\circ\text{C}$	-
Operating junction temperature	T_j	-55	-	150	$^\circ\text{C}$	-
Mounting torque	-	-	-	50	Ncm	M2.5 screws
Continuous diode forward current	I_S	-	-	10	A	$T_C=25^\circ\text{C}$
Diode pulse current ²⁾	$I_{S,pulse}$	-	-	150	A	$T_C=25^\circ\text{C}$
Reverse diode dv/dt ³⁾	dv/dt	-	-	70	V/ns	$V_{DS}=0\dots400\text{V}$, $I_{SD}\leq 10\text{A}$, $T_j=25^\circ\text{C}$ see table 8
Maximum diode commutation speed	di _F /dt	-	-	1300	A/ μs	$V_{DS}=0\dots400\text{V}$, $I_{SD}\leq 10\text{A}$, $T_j=25^\circ\text{C}$ see table 8
Insulation withstand voltage	V_{ISO}	-	-	2500	V	V_{rms} , $T_C=25^\circ\text{C}$, $t=1\text{min}$

¹⁾ Limited by $T_{j,max}$. Maximum Duty Cycle $D = 0.50$

²⁾ Pulse width t_p limited by $T_{j,max}$

³⁾ Identical low side and high side switch with identical R_θ

2 Thermal characteristics

Table 3 Thermal characteristics

Parameter	Symbol	Values			Unit	Note / Test Condition
		Min.	Typ.	Max.		
Thermal resistance, junction - case	R_{thJC}	-	-	3.80	°C/W	-
Thermal resistance, junction - ambient	R_{thJA}	-	-	62	°C/W	leaded
Thermal resistance, junction - ambient for SMD version	R_{thJA}	-	-	-	°C/W	n.a.
Soldering temperature, wavesoldering only allowed at leads	T_{sold}	-	-	260	°C	1.6mm (0.063 in.) from case for 10s

3 Electrical characteristics

at $T_j=25^\circ\text{C}$, unless otherwise specified

Table 4 Static characteristics

Parameter	Symbol	Values			Unit	Note / Test Condition
		Min.	Typ.	Max.		
Drain-source breakdown voltage	$V_{(BR)DSS}$	950	-	-	V	$V_{GS}=0\text{V}$, $I_D=1\text{mA}$
Gate threshold voltage	$V_{(GS)th}$	2.5	3	3.5	V	$V_{DS}=V_{GS}$, $I_D=1.25\text{mA}$
Zero gate voltage drain current	I_{DSS}	-	-	1	μA	$V_{DS}=950\text{V}$, $V_{GS}=0\text{V}$, $T_j=25^\circ\text{C}$ $V_{DS}=950\text{V}$, $V_{GS}=0\text{V}$, $T_j=150^\circ\text{C}$
Gate-source leakage current	I_{GSS}	-	-	100	nA	$V_{GS}=20\text{V}$, $V_{DS}=0\text{V}$
Drain-source on-state resistance	$R_{DS(on)}$	-	0.1 0.27	0.13	Ω	$V_{GS}=10\text{V}$, $I_D=25.1\text{A}$, $T_j=25^\circ\text{C}$ $V_{GS}=10\text{V}$, $I_D=25.1\text{A}$, $T_j=150^\circ\text{C}$
Gate resistance	R_G	-	0.9	-	Ω	$f=250\text{kHz}$, open drain

Table 5 Dynamic characteristics

Parameter	Symbol	Values			Unit	Note / Test Condition
		Min.	Typ.	Max.		
Input capacitance	C_{iss}	-	4170	-	pF	$V_{GS}=0\text{V}$, $V_{DS}=400\text{V}$, $f=250\text{kHz}$
Output capacitance	C_{oss}	-	53	-	pF	$V_{GS}=0\text{V}$, $V_{DS}=400\text{V}$, $f=250\text{kHz}$
Effective output capacitance, energy related ¹⁾	$C_{o(er)}$	-	88	-	pF	$V_{GS}=0\text{V}$, $V_{DS}=0\dots400\text{V}$
Effective output capacitance, time related ²⁾	$C_{o(tr)}$	-	894	-	pF	$I_D=\text{constant}$, $V_{GS}=0\text{V}$, $V_{DS}=0\dots400\text{V}$
Turn-on delay time	$t_{d(on)}$	-	25	-	ns	$V_{DD}=400\text{V}$, $V_{GS}=13\text{V}$, $I_D=25.1\text{A}$, $R_G=5.3\Omega$; see table 9
Rise time	t_r	-	14	-	ns	$V_{DD}=400\text{V}$, $V_{GS}=13\text{V}$, $I_D=25.1\text{A}$, $R_G=5.3\Omega$; see table 9
Turn-off delay time	$t_{d(off)}$	-	118	-	ns	$V_{DD}=400\text{V}$, $V_{GS}=13\text{V}$, $I_D=25.1\text{A}$, $R_G=5.3\Omega$; see table 9
Fall time	t_f	-	3.6	-	ns	$V_{DD}=400\text{V}$, $V_{GS}=13\text{V}$, $I_D=25.1\text{A}$, $R_G=5.3\Omega$; see table 9

Table 6 Gate charge characteristics

Parameter	Symbol	Values			Unit	Note / Test Condition
		Min.	Typ.	Max.		
Gate to source charge	Q_{gs}	-	19	-	nC	$V_{DD}=760\text{V}$, $I_D=25.1\text{A}$, $V_{GS}=0$ to 10V
Gate to drain charge	Q_{gd}	-	43	-	nC	$V_{DD}=760\text{V}$, $I_D=25.1\text{A}$, $V_{GS}=0$ to 10V
Gate charge total	Q_g	-	141	-	nC	$V_{DD}=760\text{V}$, $I_D=25.1\text{A}$, $V_{GS}=0$ to 10V
Gate plateau voltage	V_{plateau}	-	4.5	-	V	$V_{DD}=760\text{V}$, $I_D=25.1\text{A}$, $V_{GS}=0$ to 10V

¹⁾ $C_{o(er)}$ is a fixed capacitance that gives the same stored energy as C_{oss} while V_{DS} is rising from 0 to 400V

²⁾ $C_{o(tr)}$ is a fixed capacitance that gives the same charging time as C_{oss} while V_{DS} is rising from 0 to 400V

Table 7 Reverse diode characteristics

Parameter	Symbol	Values			Unit	Note / Test Condition
		Min.	Typ.	Max.		
Diode forward voltage	V_{SD}	-	1.1	-	V	$V_{GS}=0V, I_F=25.1A, T_j=25^{\circ}C$
Reverse recovery time	t_{rr}	-	153	-	ns	$V_R=400V, I_F=25.1A, di_F/dt=100A/\mu s$; see table 8
Reverse recovery charge	Q_{rr}	-	1.10	-	μC	$V_R=400V, I_F=25.1A, di_F/dt=100A/\mu s$; see table 8
Peak reverse recovery current	I_{rrm}	-	14.0	-	A	$V_R=400V, I_F=25.1A, di_F/dt=100A/\mu s$; see table 8

4 Electrical characteristics diagrams

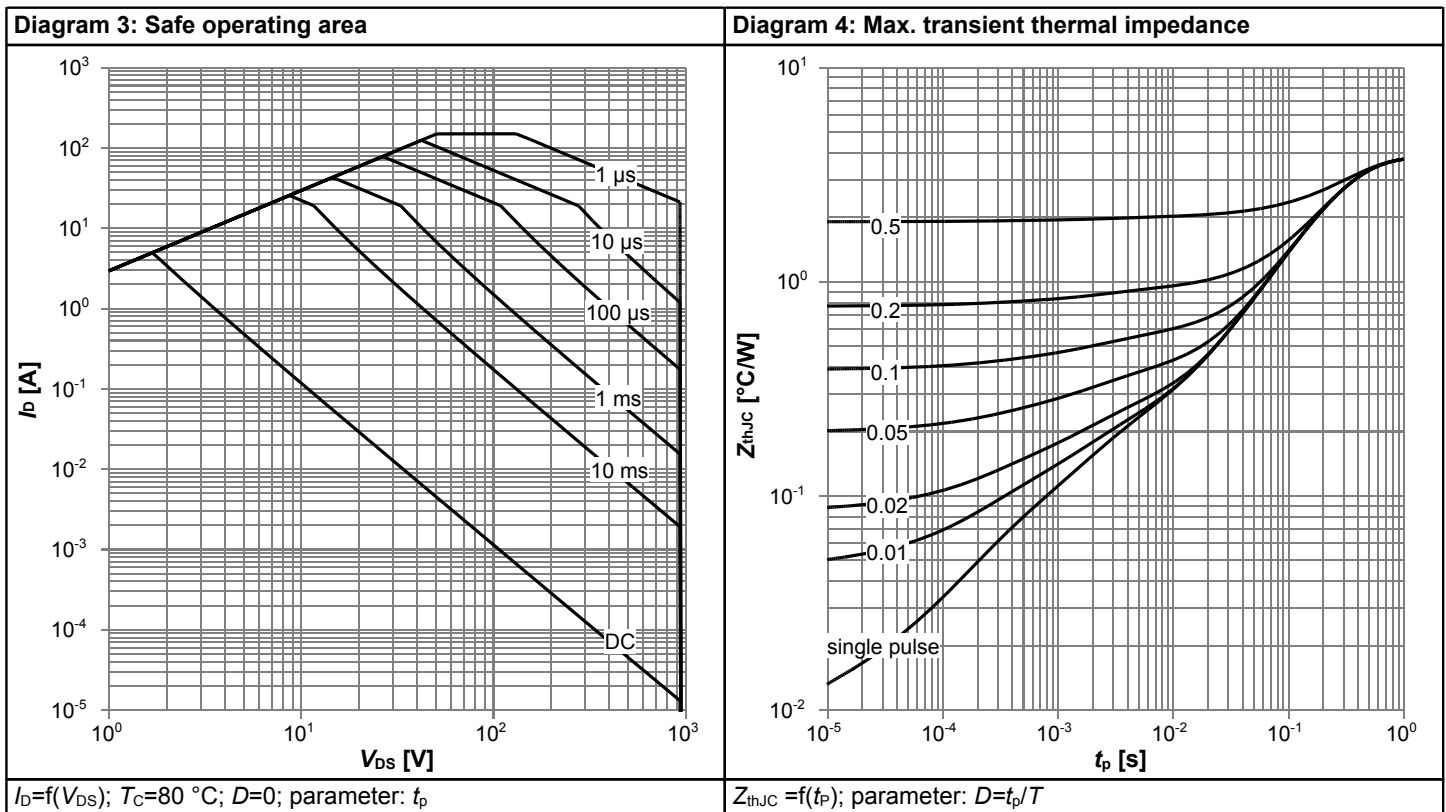
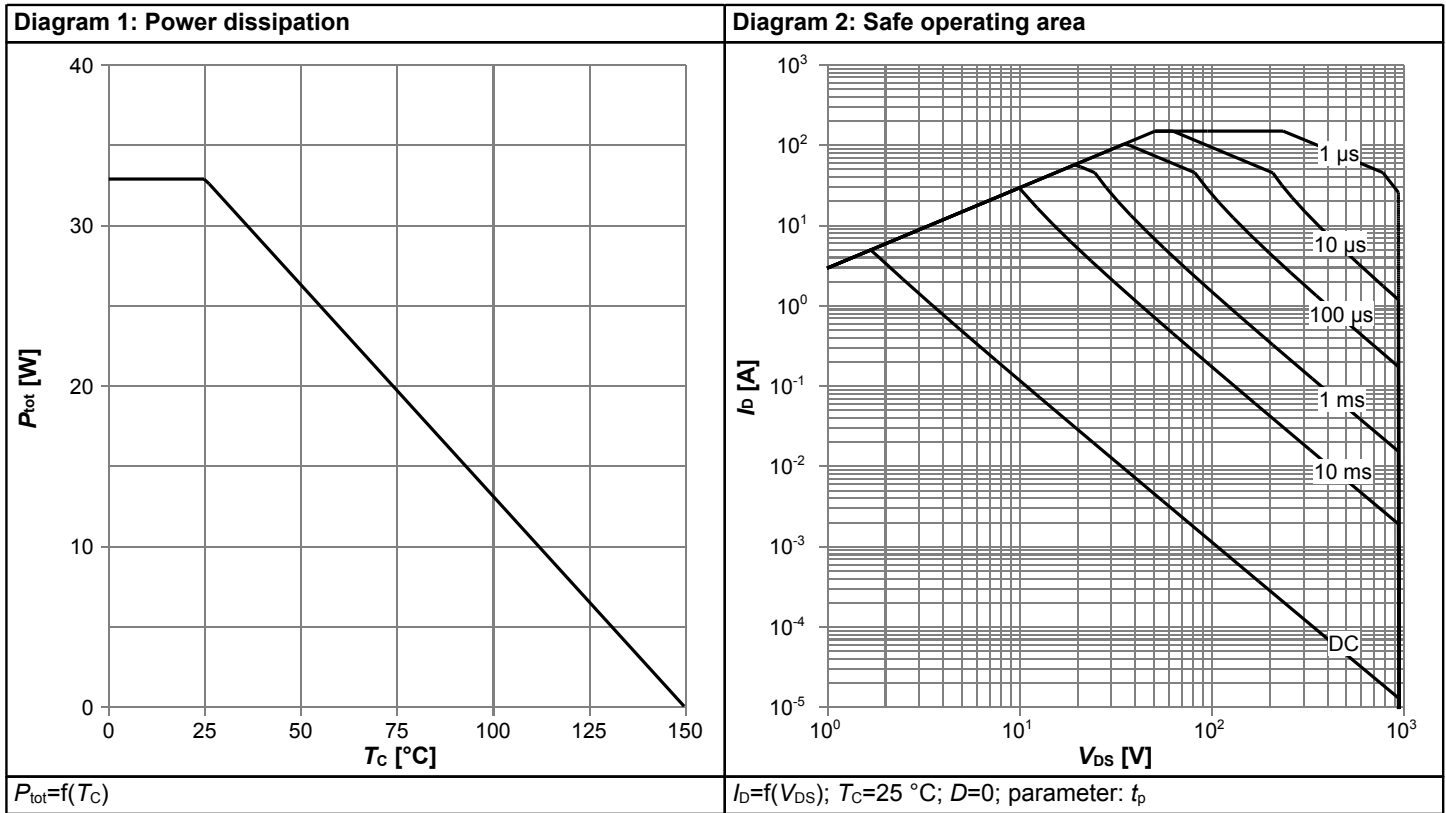
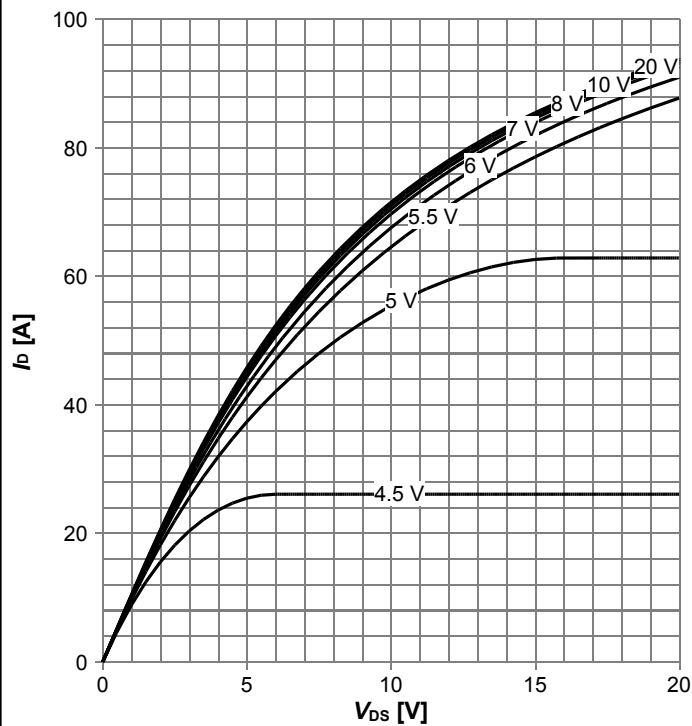
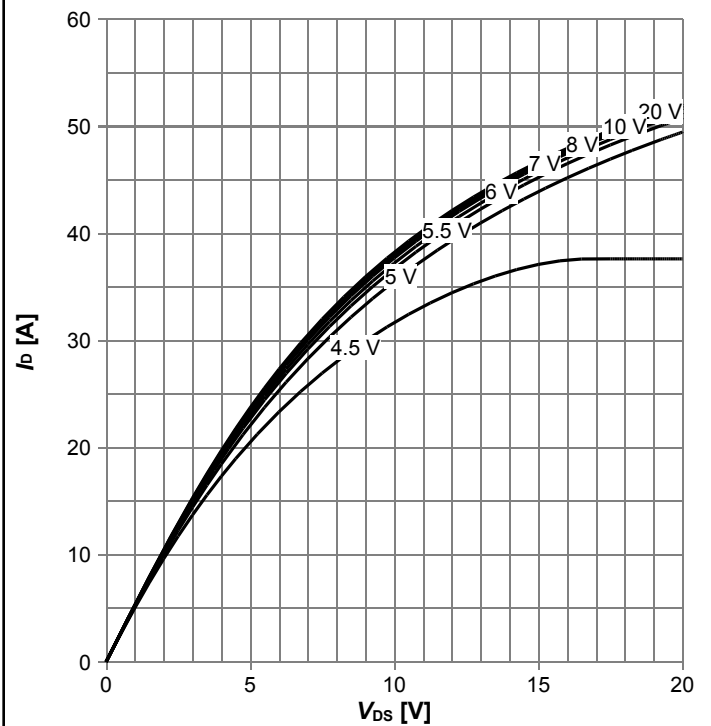

Diagram 5: Typ. output characteristics



$I_D=f(V_{DS}); T_j=25\text{ °C};$ parameter: V_{GS}

Diagram 6: Typ. output characteristics



$I_D=f(V_{DS}); T_j=125\text{ °C};$ parameter: V_{GS}

Diagram 7: Typ. drain-source on-state resistance

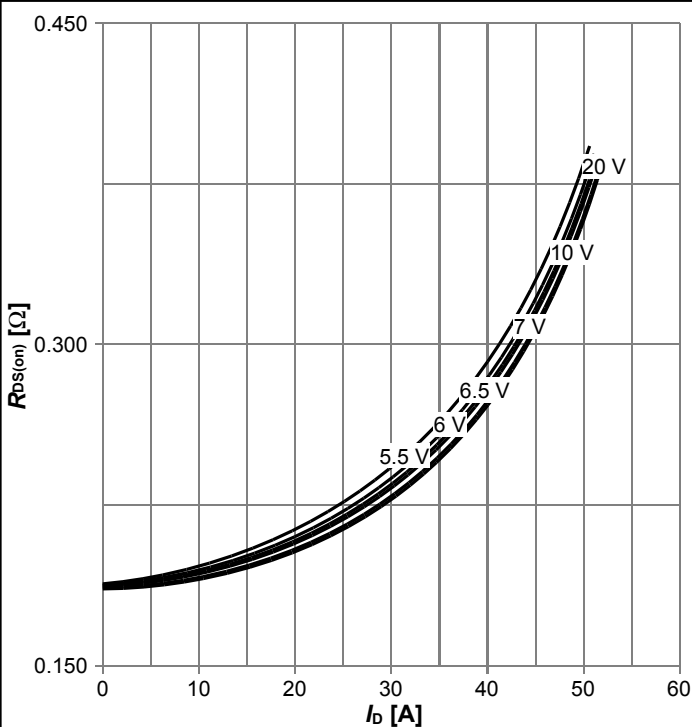

$R_{DS(on)}=f(I_D); T_j=125\text{ °C};$ parameter: V_{GS}

Diagram 8: Drain-source on-state resistance

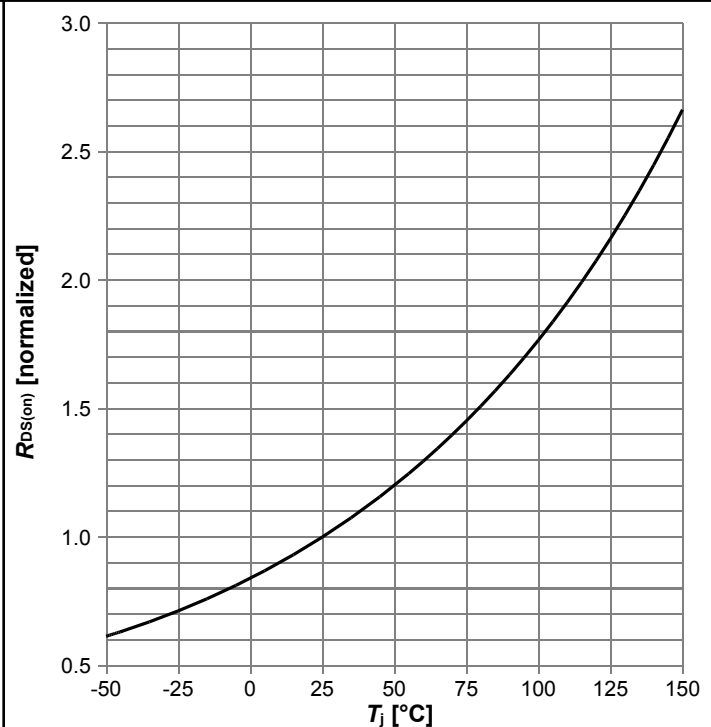

$R_{DS(on)}=f(T_j); I_D=25.1\text{ A}; V_{GS}=10\text{ V}$

Diagram 9: Typ. transfer characteristics

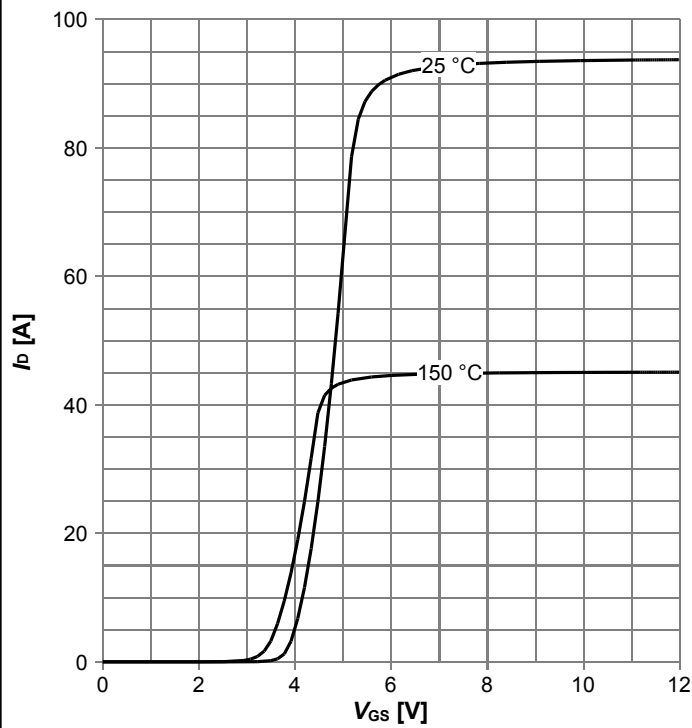

$I_D=f(V_{GS})$; $V_{DS}=20V$; parameter: T_j

Diagram 10: Typ. gate charge

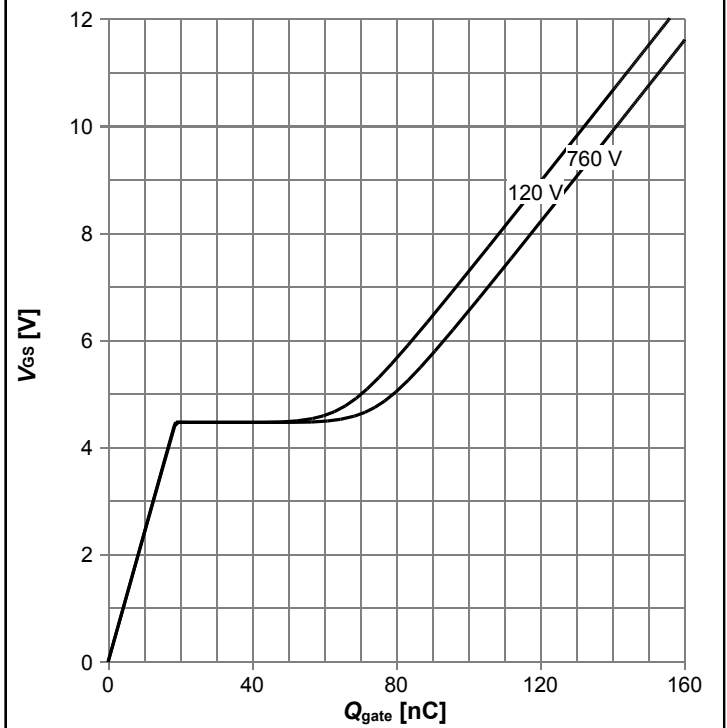

$V_{GS}=f(Q_{gate})$; $I_D=25.1$ A pulsed; parameter: V_{DD}

Diagram 11: Forward characteristics of reverse diode

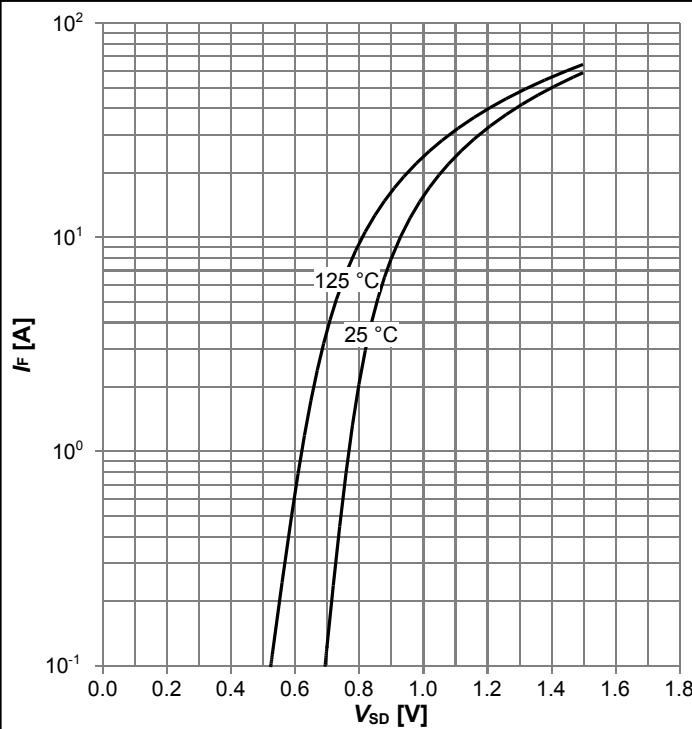

$I_F=f(V_{SD})$; parameter: T_j

Diagram 12: Avalanche energy

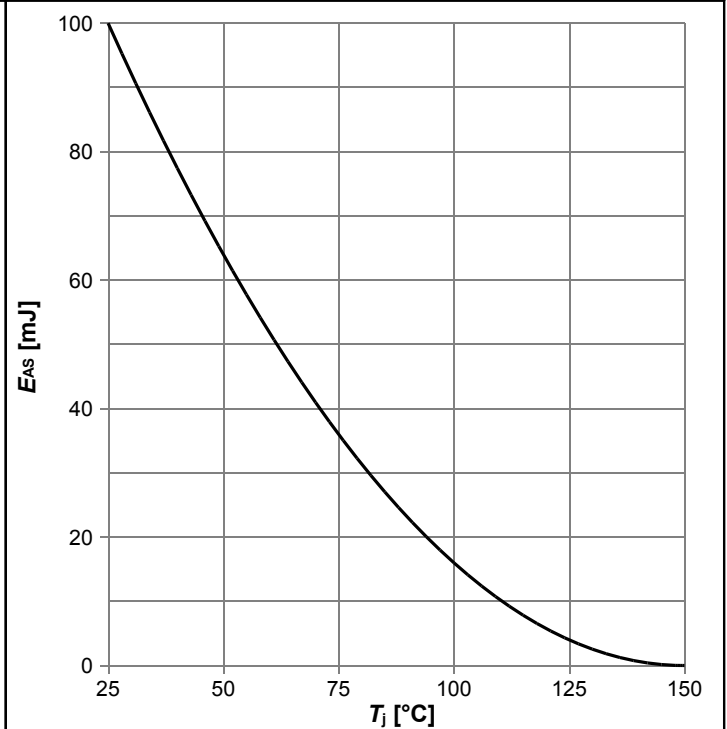

$E_{AS}=f(T_j)$; $I_D=3.8$ A; $V_{DD}=50$ V

Diagram 13: Drain-source breakdown voltage

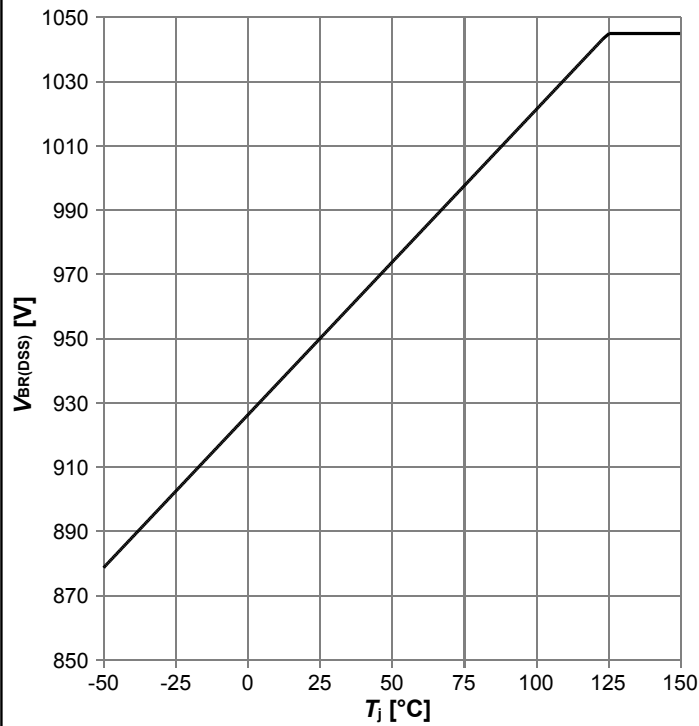

$V_{BR(DSS)}=f(T_j); I_D=1\text{ mA}$

Diagram 14: Typ. capacitances

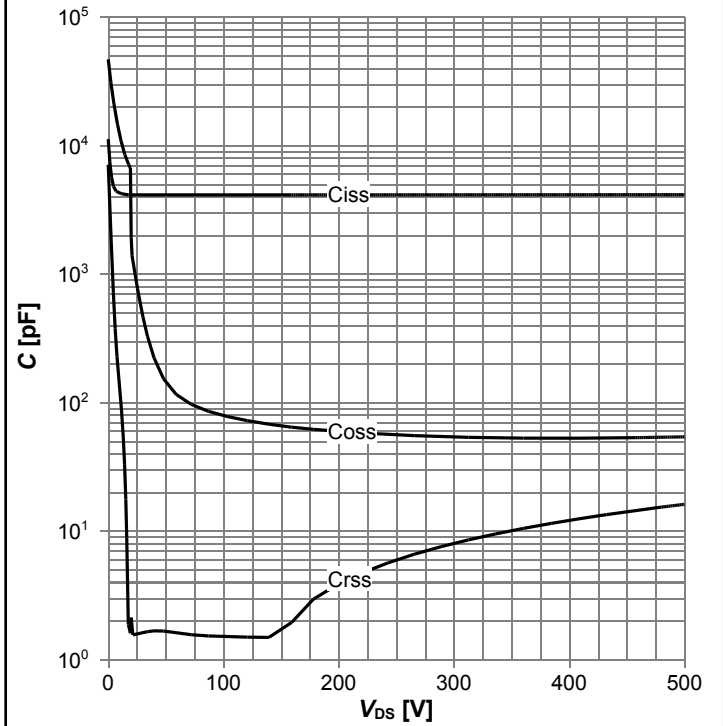

$C=f(V_{DS}); V_{GS}=0\text{ V}; f=250\text{ kHz}$

Diagram 15: Typ. Coss stored energy

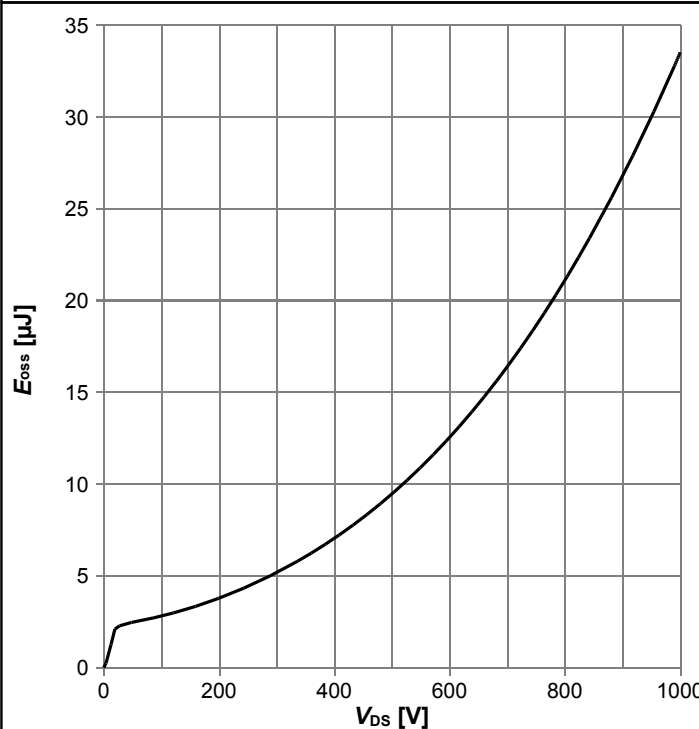

$E_{oss}=f(V_{DS})$

5 Test Circuits

Table 8 Diode characteristics



Table 9 Switching times



Table 10 Unclamped inductive load



6 Package Outlines

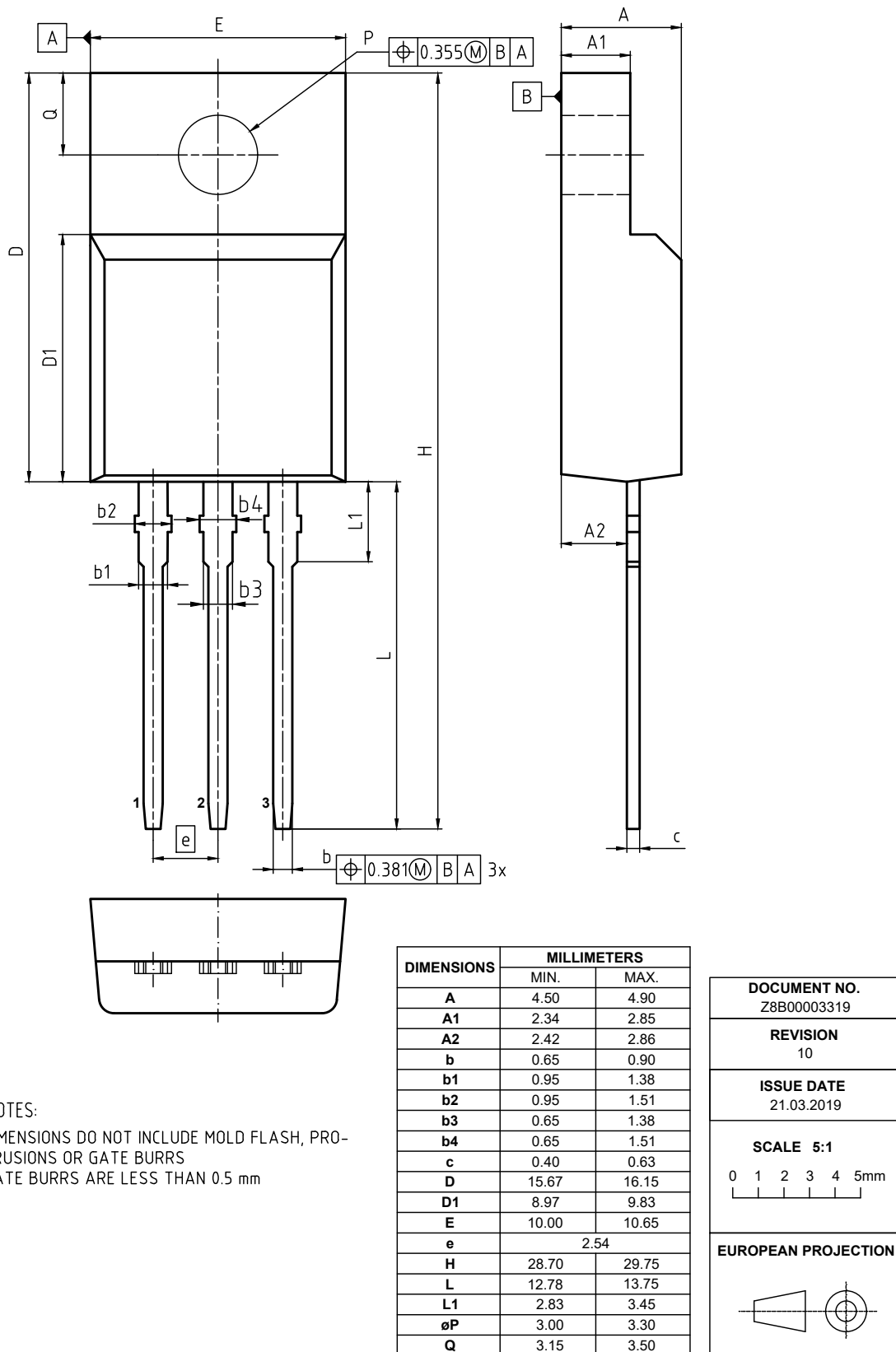

Figure 1 Outline PG-TO220 FullPAK, dimensions in mm

7 Appendix A

Table 11 Related Links

- IFX CoolMOS PFD7 950V Webpage: www.infineon.com
- IFX CoolMOS PFD7 950V application note: www.infineon.com
- IFX CoolMOS PFD7 950V simulation model: www.infineon.com
- IFX Design tools: www.infineon.com

Revision History

IPA95R130PFD7

Revision: 2022-04-22, Rev. 2.1

Previous Revision

Revision	Date	Subjects (major changes since last revision)
2.0	2022-03-18	Release of final version
2.1	2022-04-22	Modified features

Trademarks

All referenced product or service names and trademarks are the property of their respective owners.

We Listen to Your Comments

Any information within this document that you feel is wrong, unclear or missing at all? Your feedback will help us to continuously improve the quality of this document. Please send your proposal (including a reference to this document) to:

erratum@infineon.com

Published by

Infineon Technologies AG

81726 München, Germany

© 2022 Infineon Technologies AG

All Rights Reserved.

Legal Disclaimer

The information given in this document shall in no event be regarded as a guarantee of conditions or characteristics ("Beschaffungsgarantie").

With respect to any examples, hints or any typical values stated herein and/or any information regarding the application of the product, Infineon Technologies hereby disclaims any and all warranties and liabilities of any kind, including without limitation warranties of non-infringement of intellectual property rights of any third party.

In addition, any information given in this document is subject to customer's compliance with its obligations stated in this document and any applicable legal requirements, norms and standards concerning customer's products and any use of the product of Infineon Technologies in customer's applications.

The data contained in this document is exclusively intended for technically trained staff. It is the responsibility of customer's technical departments to evaluate the suitability of the product for the intended application and the completeness of the product information given in this document with respect to such application.

Information

For further information on technology, delivery terms and conditions and prices please contact your nearest Infineon Technologies Office (www.infineon.com).

Warnings

Due to technical requirements, components may contain dangerous substances. For information on the types in question, please contact the nearest Infineon Technologies Office.

The Infineon Technologies component described in this Data Sheet may be used in life-support devices or systems and/or automotive, aviation and aerospace applications or systems only with the express written approval of Infineon Technologies, if a failure of such components can reasonably be expected to cause the failure of that life-support, automotive, aviation and aerospace device or system or to affect the safety or effectiveness of that device or system. Life support devices or systems are intended to be implanted in the human body or to support and/or maintain and sustain and/or protect human life. If they fail, it is reasonable to assume that the health of the user or other persons may be endangered.

X-ON Electronics

Largest Supplier of Electrical and Electronic Components

Click to view similar products for [Infineon manufacturer](#):

Other Similar products are found below :

[0209085P001](#) [10TQ045](#) [111-4189PBF](#) [111-4190PBF](#) [16-1870-01](#) [16RIA80](#) [1EBN1001AEXUMA1](#) [1ED020I12-B2](#) [1ED020I12B2XUMA1](#)
[1ED020I12-BT](#) [1ED020I12BTXUMA1](#) [1ED020I12-F](#) [1ED020I12-F2](#) [1ED020I12F2XUMA1](#) [1ED020I12FA2](#) [1ED020I12FA2XUMA2](#)
[1ED020I12-FT](#) [1ED020I12FTA](#) [1ED020I12FTAXUMA2](#) [1ED3120MU12HXUMA1](#) [1ED3121MU12HXUMA1](#) [1ED3122MC12HXUMA1](#)
[1ED3122MU12HXUMA1](#) [1ED3123MC12HXUMA1](#) [1ED3123MU12HXUMA1](#) [1ED3124MC12HXUMA1](#) [1ED3124MU12HXUMA1](#)
[1ED3131MU12HXUMA1](#) [1ED3140MU12FXUMA1](#) [1ED3141MU12FXUMA1](#) [1ED3142MU12FXUMA1](#) [1ED3241MC12HXUMA1](#)
[1ED3321MC12NXUMA1](#) [1ED3323MC12NXUMA1](#) [1ED3431MU12MXUMA1](#) [1ED3461MU12MXUMA1](#) [1ED3491MC12MXUMA1](#)
[1ED3491MU12MXUMA1](#) [1ED3860MU12MXUMA1](#) [1ED3890MU12MXUMA1](#) [1ED44173N01BXTSA1](#) [1ED44175N01BXTSA1](#)
[1ED44176N01FXUMA1](#) [1EDB7275F](#) [1EDB7275FXUMA1](#) [1EDB8275FXUMA1](#) [1EDB9275FXUMA1](#) [1EDC05I12AHXUMA1](#)
[1EDC10I12MHXUMA1](#) [1EDC20H12AH](#)