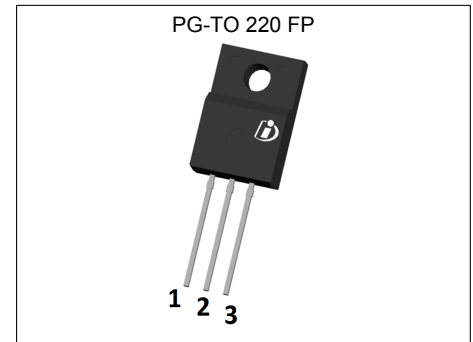


## MOSFET

### 600V CoolMOS™ P7 Power Transistor

The CoolMOS™ 7th generation platform is a revolutionary technology for high voltage power MOSFETs, designed according to the superjunction (SJ) principle and pioneered by Infineon Technologies. The 600V CoolMOS™ P7 series is the successor to the CoolMOS™ P6 series. It combines the benefits of a fast switching SJ MOSFET with excellent ease of use, e.g. very low ringing tendency, outstanding robustness of body diode against hard commutation and excellent ESD capability. Furthermore, extremely low switching and conduction losses make switching applications even more efficient, more compact and much cooler.

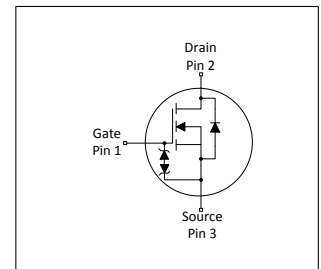


### Features

- Suitable for hard and soft switching (PFC and LLC) due to an outstanding commutation ruggedness
- Significant reduction of switching and conduction losses
- Excellent ESD robustness >2kV (HBM) for all products
- Better  $R_{DS(on)}/\text{package}$  products compared to competition enabled by a low  $R_{DS(on)} \cdot A$  (below  $10\text{m}\Omega \cdot \text{mm}^2$ )

### Benefits

- Ease of use and fast design-in through low ringing tendency and usage across PFC and PWM stages
- Simplified thermal management due to low switching and conduction losses
- Increased power density solutions enabled by using products with smaller footprint and higher manufacturing quality due to >2 kV ESD protection
- Suitable for a wide variety of applications and power ranges



### Potential applications

PFC stages, hard switching PWM stages and resonant switching stages for e.g. PC Silverbox, Adapter, LCD & PDP TV, Lighting, Server, Telecom and UPS.

### Product validation

Qualified according to JEDEC Standard

*Please note: For MOSFET paralleling the use of ferrite beads on the gate or separate totem poles is generally recommended.*

**Table 1 Key Performance Parameters**

| Parameter            | Value | Unit                   |
|----------------------|-------|------------------------|
| $V_{DS} @ T_{j,max}$ | 650   | V                      |
| $R_{DS(on),max}$     | 360   | $\text{m}\Omega$       |
| $Q_{g,typ}$          | 13    | nC                     |
| $I_{D,pulse}$        | 26    | A                      |
| $E_{oss} @ 400V$     | 1.6   | $\mu\text{J}$          |
| Body diode $di_F/dt$ | 900   | $\text{A}/\mu\text{s}$ |

| Type / Ordering Code | Package                         | Marking  | Related Links  |
|----------------------|---------------------------------|----------|----------------|
| IPAN60R360P7S        | PG-TO 220 FullPAK - Narrow Lead | 60S360P7 | see Appendix A |

## Table of Contents

|   |    |
|---|----|
| Description .....                         | 1  |
| Maximum ratings .....                     | 3  |
| Thermal characteristics .....             | 4  |
| Electrical characteristics .....          | 5  |
| Electrical characteristics diagrams ..... | 7  |
| Test Circuits .....                       | 11 |
| Package Outlines .....                    | 12 |
| Appendix A .....                          | 13 |
| Revision History .....                    | 14 |
| Trademarks .....                          | 14 |
| Disclaimer .....                          | 14 |

## 1 Maximum ratings

at  $T_j = 25^\circ\text{C}$ , unless otherwise specified

**Table 2 Maximum ratings**

| Parameter                              | Symbol              | Values |      |        | Unit             | Note / Test Condition   |
|--|---------------------|--------|------|--------|------------------|---|
|  |                     | Min.   | Typ. | Max.   |                  |   |
| Continuous drain current <sup>1)</sup> | $I_D$               | -      | -    | 9<br>6 | A                | $T_C=25^\circ\text{C}$<br>$T_C=100^\circ\text{C}$   |
| Pulsed drain current <sup>2)</sup>     | $I_{D,pulse}$       | -      | -    | 26     | A                | $T_C=25^\circ\text{C}$  |
| Avalanche energy, single pulse         | $E_{AS}$            | -      | -    | 27     | mJ               | $I_D=2.5\text{A}$ ; $V_{DD}=50\text{V}$ ; see table 10                                      |
| Avalanche energy, repetitive           | $E_{AR}$            | -      | -    | 0.14   | mJ               | $I_D=2.5\text{A}$ ; $V_{DD}=50\text{V}$ ; see table 10                                      |
| Avalanche current, single pulse        | $I_{AS}$            | -      | -    | 2.5    | A                | -   |
| MOSFET dv/dt ruggedness                | dv/dt               | -      | -    | 80     | V/ns             | $V_{DS}=0\dots400\text{V}$  |
| Gate source voltage (static)           | $V_{GS}$            | -20    | -    | 20     | V                | static;   |
| Gate source voltage (dynamic)          | $V_{GS}$            | -30    | -    | 30     | V                | AC ( $f>1\text{ Hz}$ )  |
| Power dissipation                      | $P_{tot}$           | -      | -    | 22     | W                | $T_C=25^\circ\text{C}$  |
| Storage temperature                    | $T_{stg}$           | -40    | -    | 150    | $^\circ\text{C}$ | -   |
| Operating junction temperature         | $T_j$               | -40    | -    | 150    | $^\circ\text{C}$ | -   |
| Mounting torque                        | -                   | -      | -    | 50     | Ncm              | M2.5 screws   |
| Continuous diode forward current       | $I_S$               | -      | -    | 9      | A                | $T_C=25^\circ\text{C}$  |
| Diode pulse current <sup>2)</sup>      | $I_{S,pulse}$       | -      | -    | 26     | A                | $T_C=25^\circ\text{C}$  |
| Reverse diode dv/dt <sup>3)</sup>      | dv/dt               | -      | -    | 50     | V/ns             | $V_{DS}=0\dots400\text{V}$ , $I_{SD}\leq 9\text{A}$ , $T_j=25^\circ\text{C}$<br>see table 8 |
| Maximum diode commutation speed        | di <sub>F</sub> /dt | -      | -    | 900    | A/ $\mu\text{s}$ | $V_{DS}=0\dots400\text{V}$ , $I_{SD}\leq 9\text{A}$ , $T_j=25^\circ\text{C}$<br>see table 8 |
| Insulation withstand voltage           | $V_{ISO}$           | -      | -    | 2500   | V                | $V_{rms}$ , $T_C=25^\circ\text{C}$ , $t=1\text{min}$  |

<sup>1)</sup> Limited by  $T_{j,max}$ . Maximum Duty Cycle  $D = 0.50$ ; TO-220 equivalent

<sup>2)</sup> Pulse width  $t_p$  limited by  $T_{j,max}$

<sup>3)</sup> Identical low side and high side switch with identical  $R_\theta$

## 2 Thermal characteristics

**Table 3 Thermal characteristics**

| Parameter  | Symbol     | Values |      |      | Unit | Note / Test Condition               |
|--|------------|--------|------|------|------|-------------------------------------|
|  |            | Min.   | Typ. | Max. |      |                                     |
| Thermal resistance, junction - case                        | $R_{thJC}$ | -      | -    | 5.61 | °C/W | -                                   |
| Thermal resistance, junction - ambient                     | $R_{thJA}$ | -      | -    | 62   | °C/W | leaded                              |
| Thermal resistance, junction - ambient for SMD version     | $R_{thJA}$ | -      | -    | -    | °C/W | -                                   |
| Soldering temperature, wavesoldering only allowed at leads | $T_{sold}$ | -      | -    | 260  | °C   | 1.6mm (0.063 in.) from case for 10s |

### 3 Electrical characteristics

at  $T_j=25^\circ\text{C}$ , unless otherwise specified

**Table 4 Static characteristics**

| Parameter                        | Symbol        | Values |                |            | Unit          | Note / Test Condition   |
|----------------------------------|---------------|--------|----------------|------------|---------------|---|
|                                  |               | Min.   | Typ.           | Max.       |               |   |
| Drain-source breakdown voltage   | $V_{(BR)DSS}$ | 600    | -              | -          | V             | $V_{GS}=0\text{V}$ , $I_D=1\text{mA}$   |
| Gate threshold voltage           | $V_{(GS)th}$  | 3      | 3.5            | 4          | V             | $V_{DS}=V_{GS}$ , $I_D=0.14\text{mA}$   |
| Zero gate voltage drain current  | $I_{DSS}$     | -      | -              | 1          | $\mu\text{A}$ | $V_{DS}=600\text{V}$ , $V_{GS}=0\text{V}$ , $T_j=25^\circ\text{C}$<br>$V_{DS}=600\text{V}$ , $V_{GS}=0\text{V}$ , $T_j=150^\circ\text{C}$ |
| Gate-source leakage current      | $I_{GSS}$     | -      | -              | 1000       | nA            | $V_{GS}=20\text{V}$ , $V_{DS}=0\text{V}$  |
| Drain-source on-state resistance | $R_{DS(on)}$  | -      | 0.300<br>0.702 | 0.360<br>- | $\Omega$      | $V_{GS}=10\text{V}$ , $I_D=2.7\text{A}$ , $T_j=25^\circ\text{C}$<br>$V_{GS}=10\text{V}$ , $I_D=2.7\text{A}$ , $T_j=150^\circ\text{C}$     |
| Gate resistance                  | $R_G$         | -      | 6.2            | -          | $\Omega$      | $f=1\text{MHz}$ , open drain  |

**Table 5 Dynamic characteristics**

| Parameter  | Symbol       | Values |      |      | Unit | Note / Test Condition  |
|--|--------------|--------|------|------|------|--|
|  |              | Min.   | Typ. | Max. |      |  |
| Input capacitance  | $C_{iss}$    | -      | 555  | -    | pF   | $V_{GS}=0\text{V}$ , $V_{DS}=400\text{V}$ , $f=250\text{kHz}$                                      |
| Output capacitance   | $C_{oss}$    | -      | 10   | -    | pF   | $V_{GS}=0\text{V}$ , $V_{DS}=400\text{V}$ , $f=250\text{kHz}$                                      |
| Effective output capacitance, energy related <sup>1)</sup> | $C_{o(er)}$  | -      | 20   | -    | pF   | $V_{GS}=0\text{V}$ , $V_{DS}=0\dots400\text{V}$  |
| Effective output capacitance, time related <sup>2)</sup>   | $C_{o(tr)}$  | -      | 214  | -    | pF   | $I_D=\text{constant}$ , $V_{GS}=0\text{V}$ , $V_{DS}=0\dots400\text{V}$                            |
| Turn-on delay time   | $t_{d(on)}$  | -      | 8    | -    | ns   | $V_{DD}=400\text{V}$ , $V_{GS}=13\text{V}$ , $I_D=2.7\text{A}$ ,<br>$R_G=10.0\Omega$ ; see table 9 |
| Rise time  | $t_r$        | -      | 7    | -    | ns   | $V_{DD}=400\text{V}$ , $V_{GS}=13\text{V}$ , $I_D=2.7\text{A}$ ,<br>$R_G=10.0\Omega$ ; see table 9 |
| Turn-off delay time  | $t_{d(off)}$ | -      | 42   | -    | ns   | $V_{DD}=400\text{V}$ , $V_{GS}=13\text{V}$ , $I_D=2.7\text{A}$ ,<br>$R_G=10.0\Omega$ ; see table 9 |
| Fall time  | $t_f$        | -      | 10   | -    | ns   | $V_{DD}=400\text{V}$ , $V_{GS}=13\text{V}$ , $I_D=2.7\text{A}$ ,<br>$R_G=10.0\Omega$ ; see table 9 |

**Table 6 Gate charge characteristics**

| Parameter             | Symbol        | Values |      |      | Unit | Note / Test Condition   |
|-----------------------|---------------|--------|------|------|------|---|
|                       |               | Min.   | Typ. | Max. |      |   |
| Gate to source charge | $Q_{GS}$      | -      | 3    | -    | nC   | $V_{DD}=400\text{V}$ , $I_D=2.7\text{A}$ , $V_{GS}=0$ to $10\text{V}$ |
| Gate to drain charge  | $Q_{gd}$      | -      | 4    | -    | nC   | $V_{DD}=400\text{V}$ , $I_D=2.7\text{A}$ , $V_{GS}=0$ to $10\text{V}$ |
| Gate charge total     | $Q_g$         | -      | 13   | -    | nC   | $V_{DD}=400\text{V}$ , $I_D=2.7\text{A}$ , $V_{GS}=0$ to $10\text{V}$ |
| Gate plateau voltage  | $V_{plateau}$ | -      | 5.2  | -    | V    | $V_{DD}=400\text{V}$ , $I_D=2.7\text{A}$ , $V_{GS}=0$ to $10\text{V}$ |

<sup>1)</sup>  $C_{o(er)}$  is a fixed capacitance that gives the same stored energy as  $C_{oss}$  while  $V_{DS}$  is rising from 0 to 400V

<sup>2)</sup>  $C_{o(tr)}$  is a fixed capacitance that gives the same charging time as  $C_{oss}$  while  $V_{DS}$  is rising from 0 to 400V

**Table 7 Reverse diode characteristics**

| Parameter                     | Symbol    | Values |      |      | Unit    | Note / Test Condition                                   |
|-------------------------------|-----------|--------|------|------|---------|---|
|                               |           | Min.   | Typ. | Max. |         |   |
| Diode forward voltage         | $V_{SD}$  | -      | 0.9  | -    | V       | $V_{GS}=0V, I_F=2.7A, T_j=25^\circ C$                   |
| Reverse recovery time         | $t_{rr}$  | -      | 145  | -    | ns      | $V_R=400V, I_F=1A, di_F/dt=100A/\mu s$ ;<br>see table 8 |
| Reverse recovery charge       | $Q_{rr}$  | -      | 0.74 | -    | $\mu C$ | $V_R=400V, I_F=1A, di_F/dt=100A/\mu s$ ;<br>see table 8 |
| Peak reverse recovery current | $I_{rrm}$ | -      | 11   | -    | A       | $V_R=400V, I_F=1A, di_F/dt=100A/\mu s$ ;<br>see table 8 |

**4 Electrical characteristics diagrams**

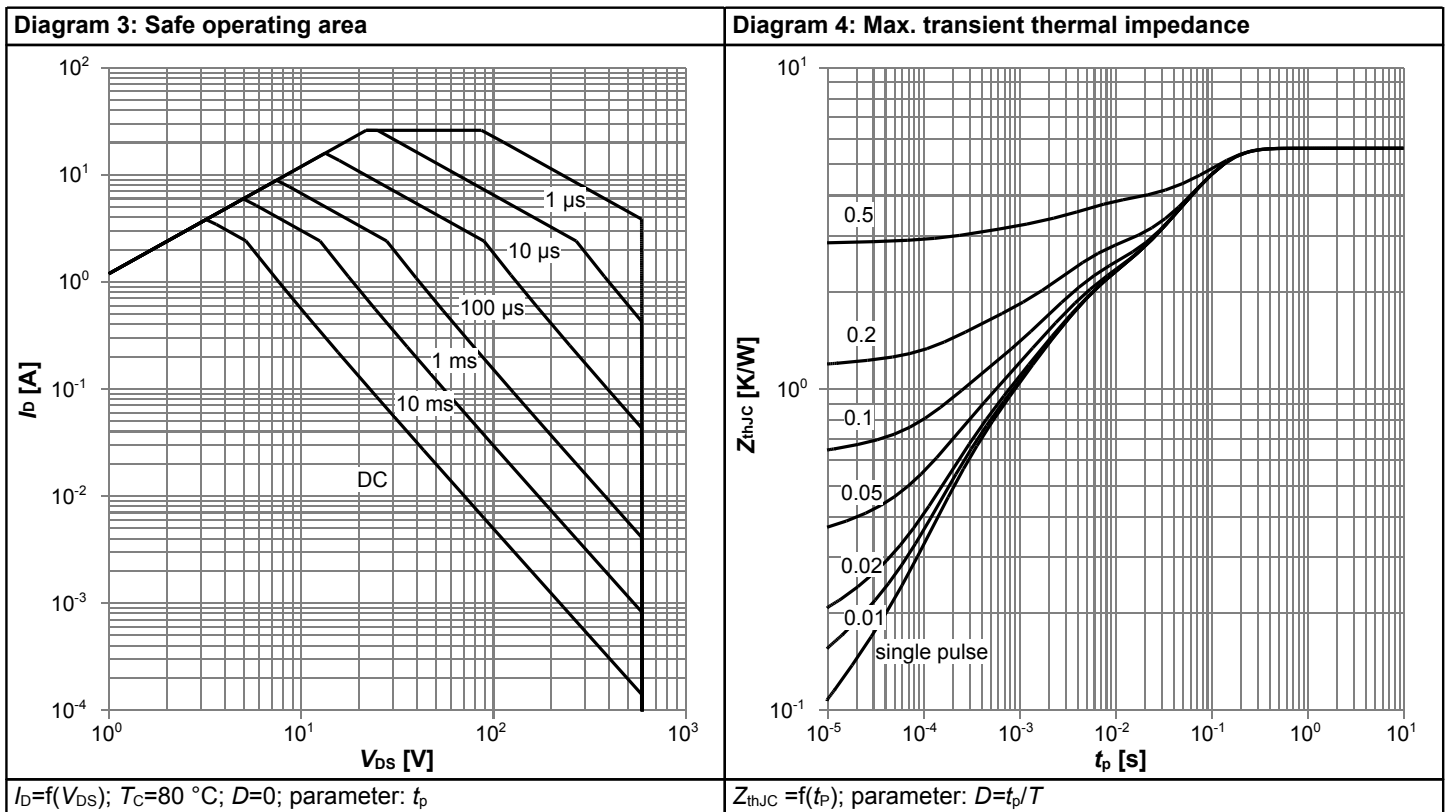
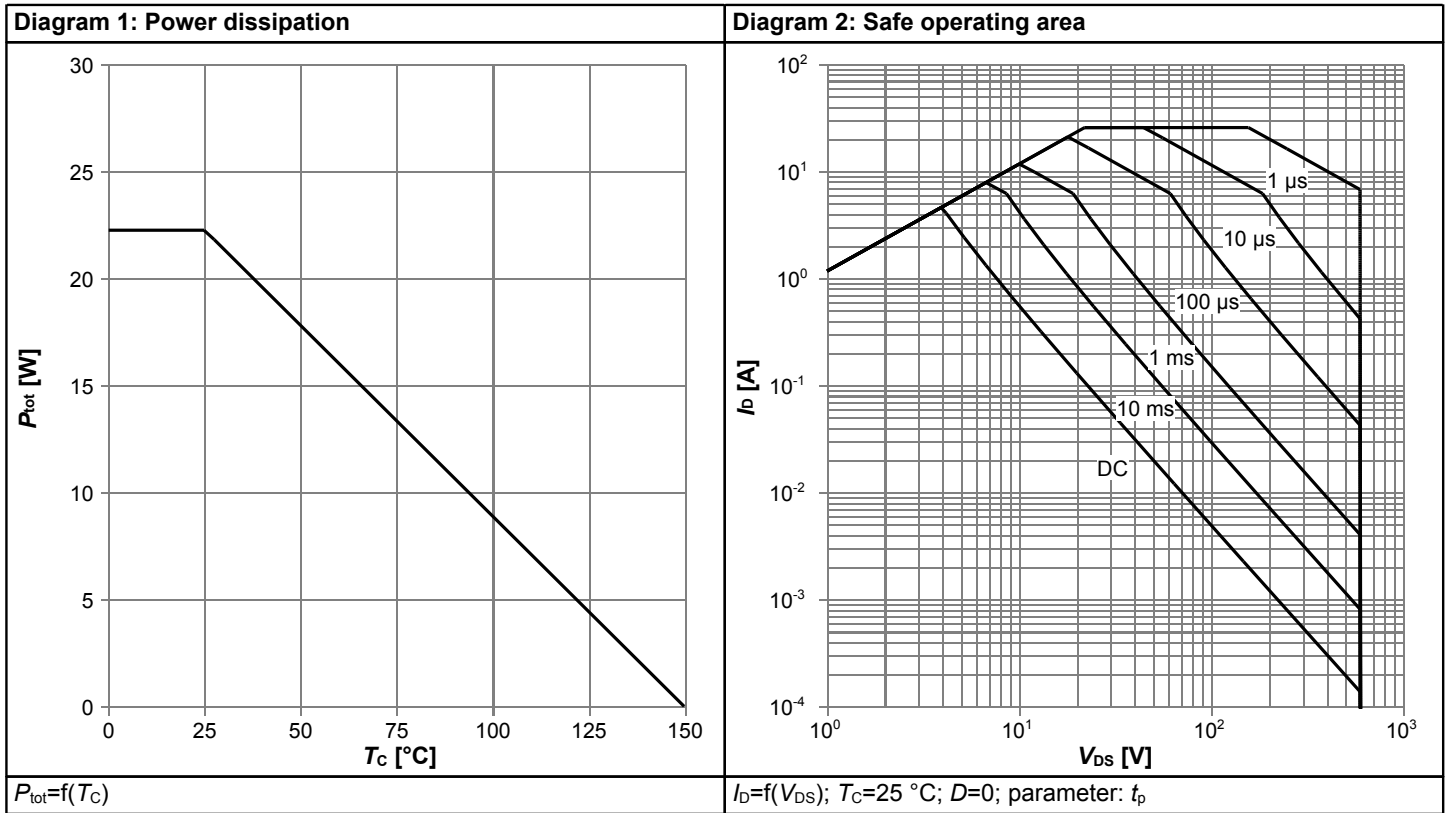
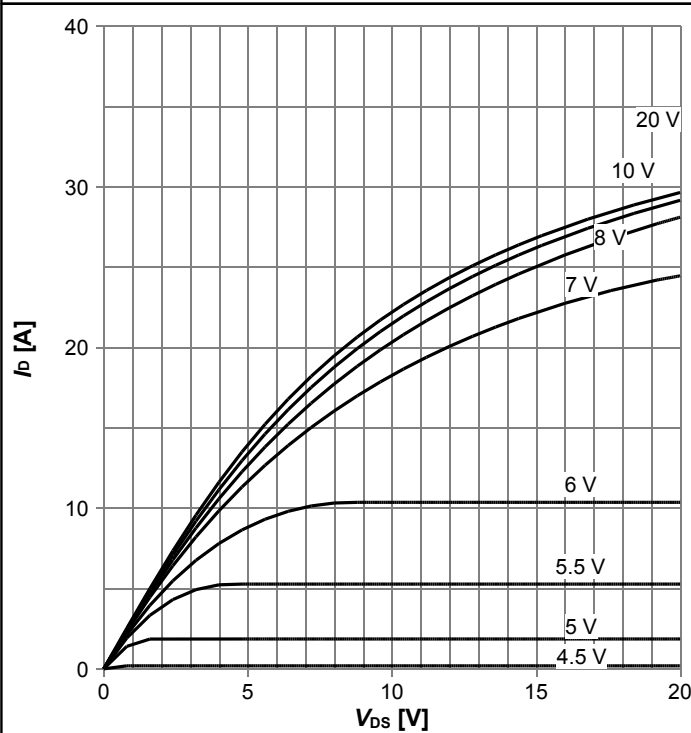
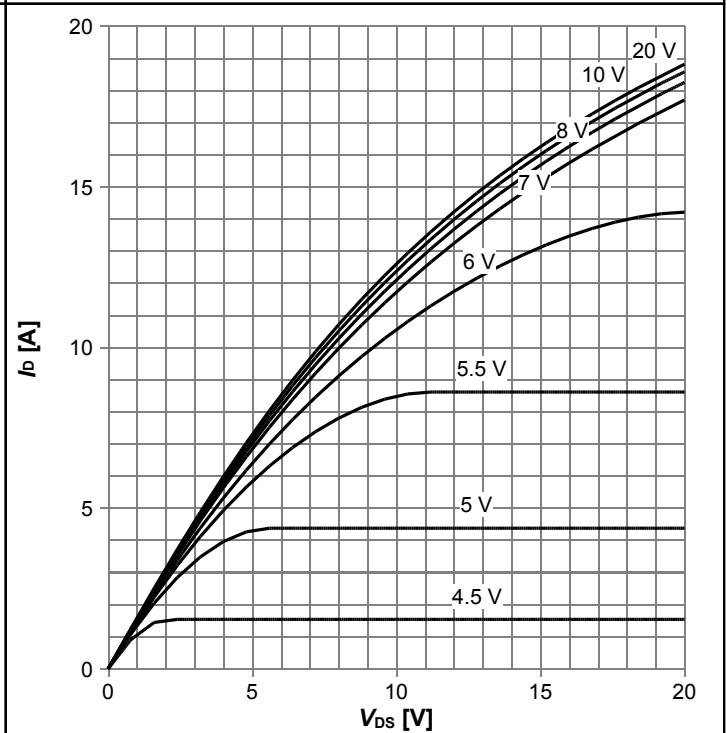


Diagram 5: Typ. output characteristics



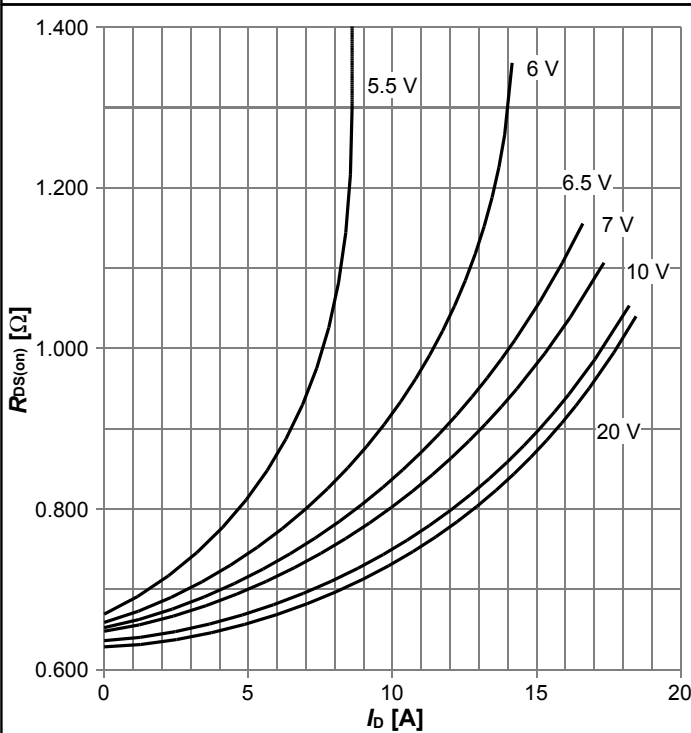
$I_D = f(V_{DS})$ ;  $T_j = 25\text{ °C}$ ; parameter:  $V_{GS}$

Diagram 6: Typ. output characteristics



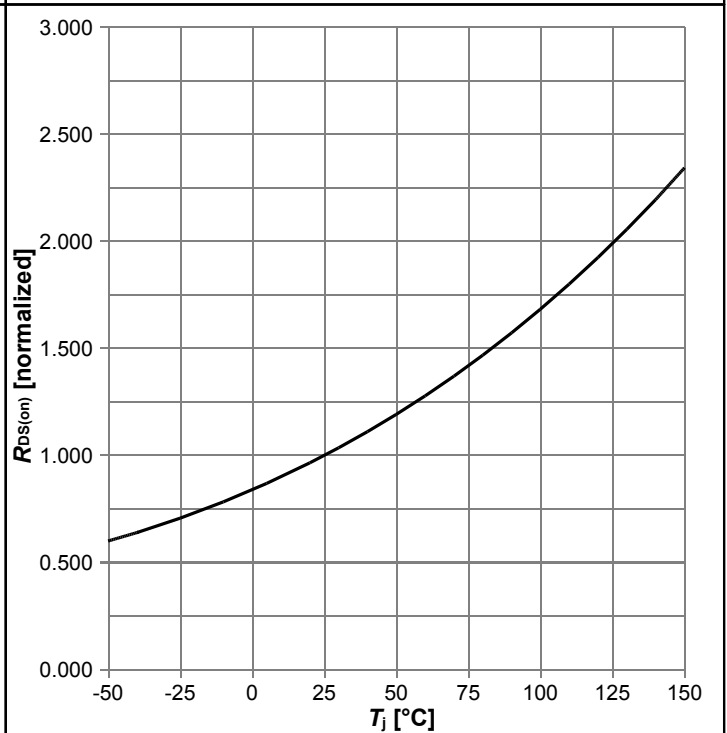
$I_D = f(V_{DS})$ ;  $T_j = 125\text{ °C}$ ; parameter:  $V_{GS}$

Diagram 7: Typ. drain-source on-state resistance



$R_{DS(on)} = f(I_D)$ ;  $T_j = 125\text{ °C}$ ; parameter:  $V_{GS}$

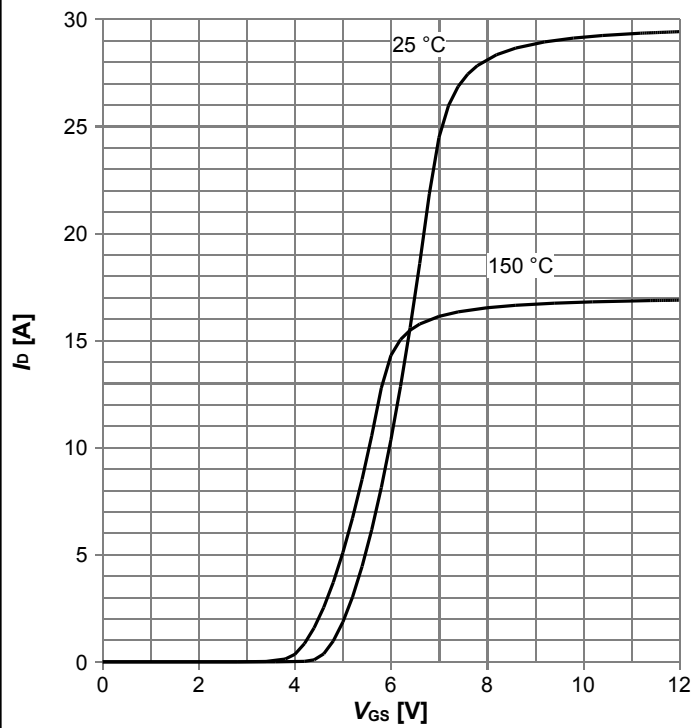
Diagram 8: Drain-source on-state resistance



$R_{DS(on)} = f(T_j)$ ;  $I_D = 2.7\text{ A}$ ;  $V_{GS} = 10\text{ V}$

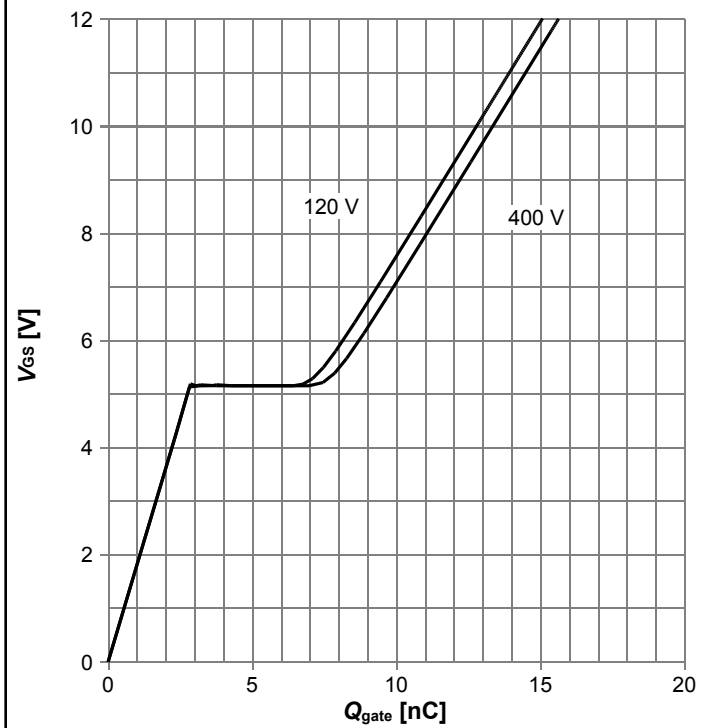


**Diagram 9: Typ. transfer characteristics**



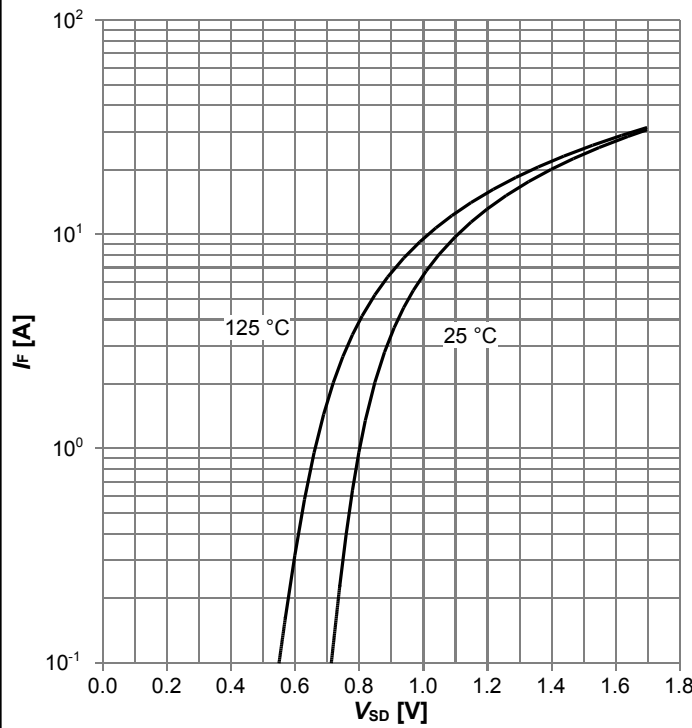
$I_D=f(V_{GS}); V_{DS}=20V$ ; parameter:  $T_j$

**Diagram 10: Typ. gate charge**



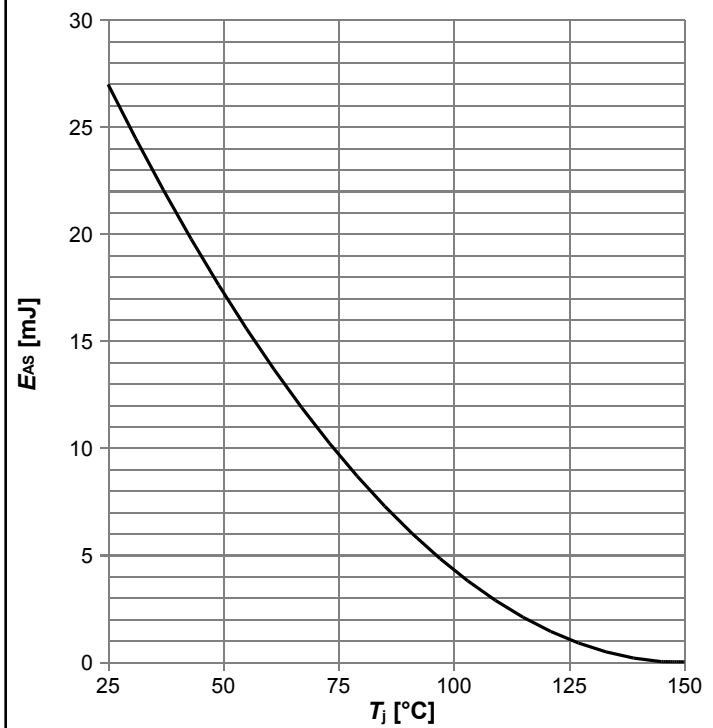
$V_{GS}=f(Q_{gate}); I_D=2.7\text{ A pulsed}$ ; parameter:  $V_{DD}$

**Diagram 11: Forward characteristics of reverse diode**



$I_F=f(V_{SD})$ ; parameter:  $T_j$

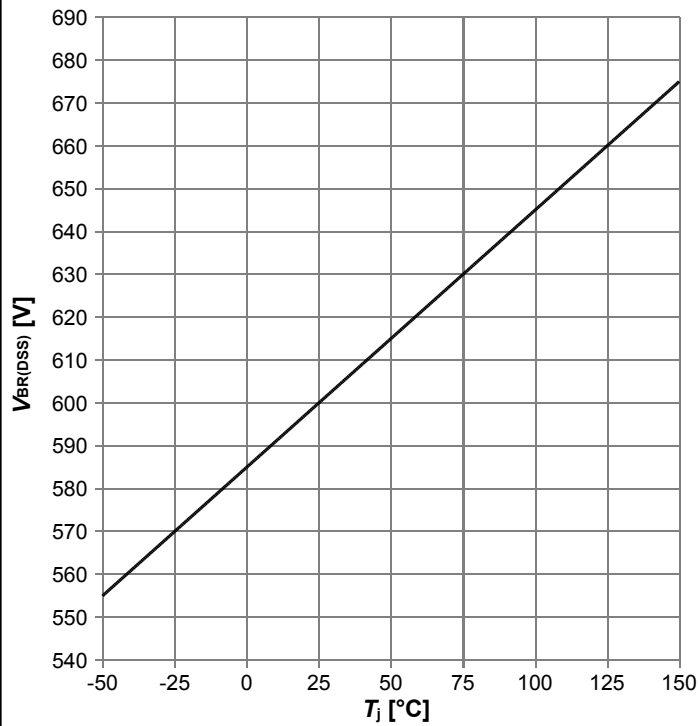
**Diagram 12: Avalanche energy**



$E_{AS}=f(T_j); I_D=2.5\text{ A}; V_{DD}=50\text{ V}$

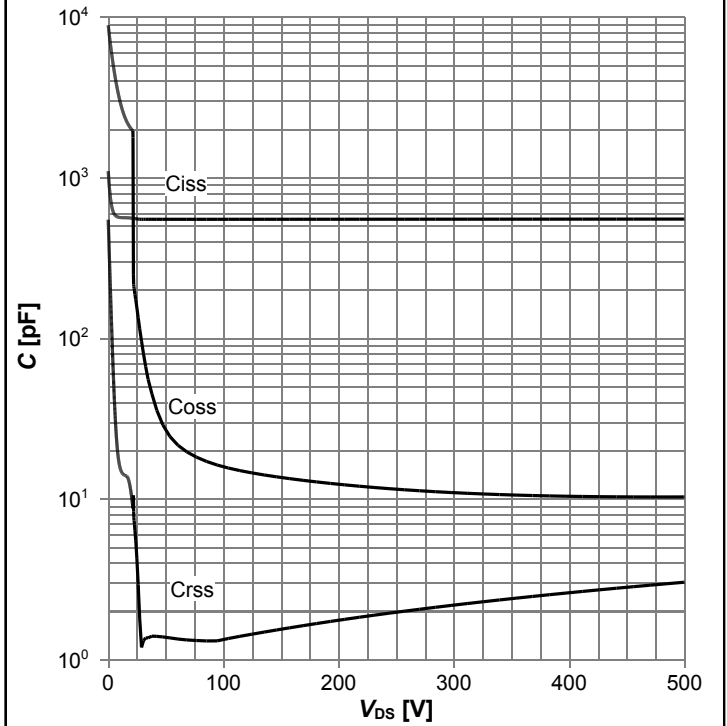
**600V CoolMOS™ P7 Power Transistor**  
**IPAN60R360P7S**

**Diagram 13: Drain-source breakdown voltage**



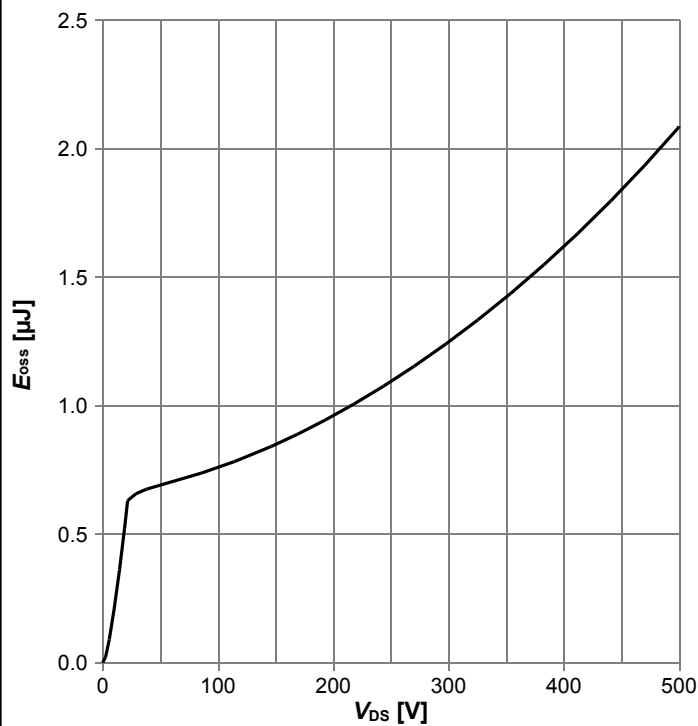
$V_{BR(DSS)}=f(T_j); I_D=1 \text{ mA}$

**Diagram 14: Typ. capacitances**



$C=f(V_{DS}); V_{GS}=0 \text{ V}; f=250 \text{ kHz}$

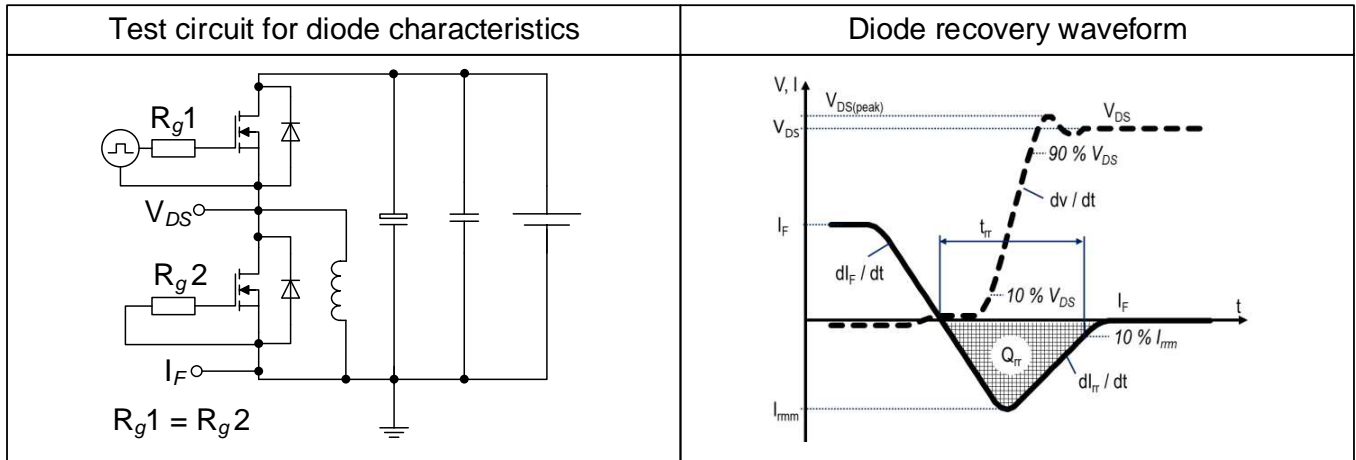
**Diagram 15: Typ. Coss stored energy**



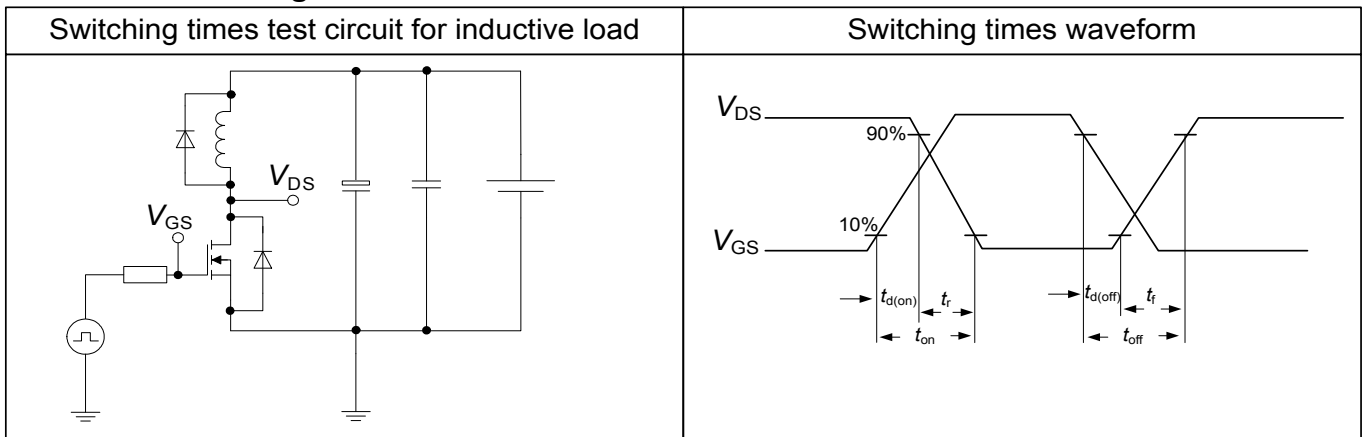
$E_{oss}=f(V_{DS})$

## 5 Test Circuits

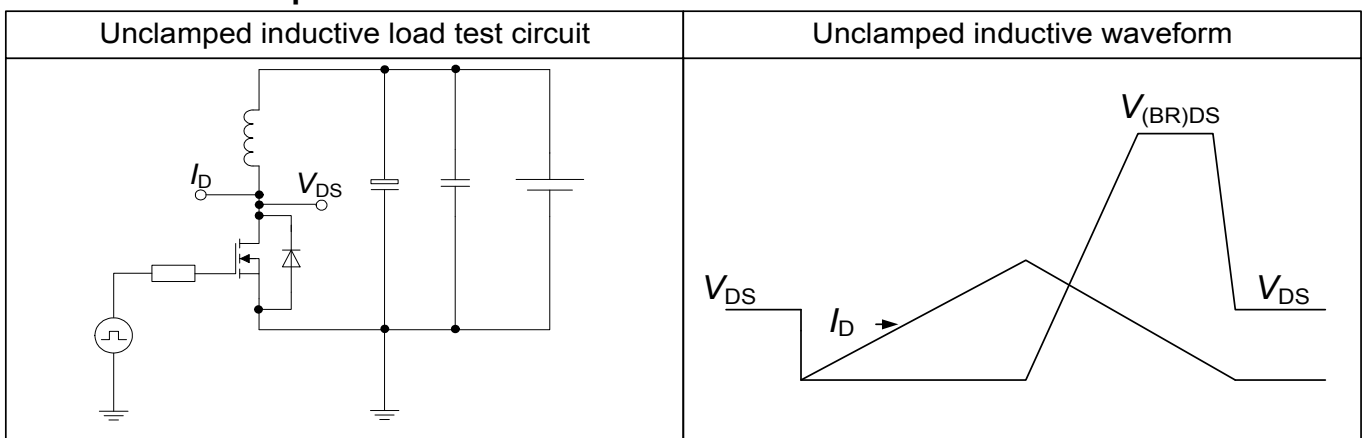
**Table 8 Diode characteristics**



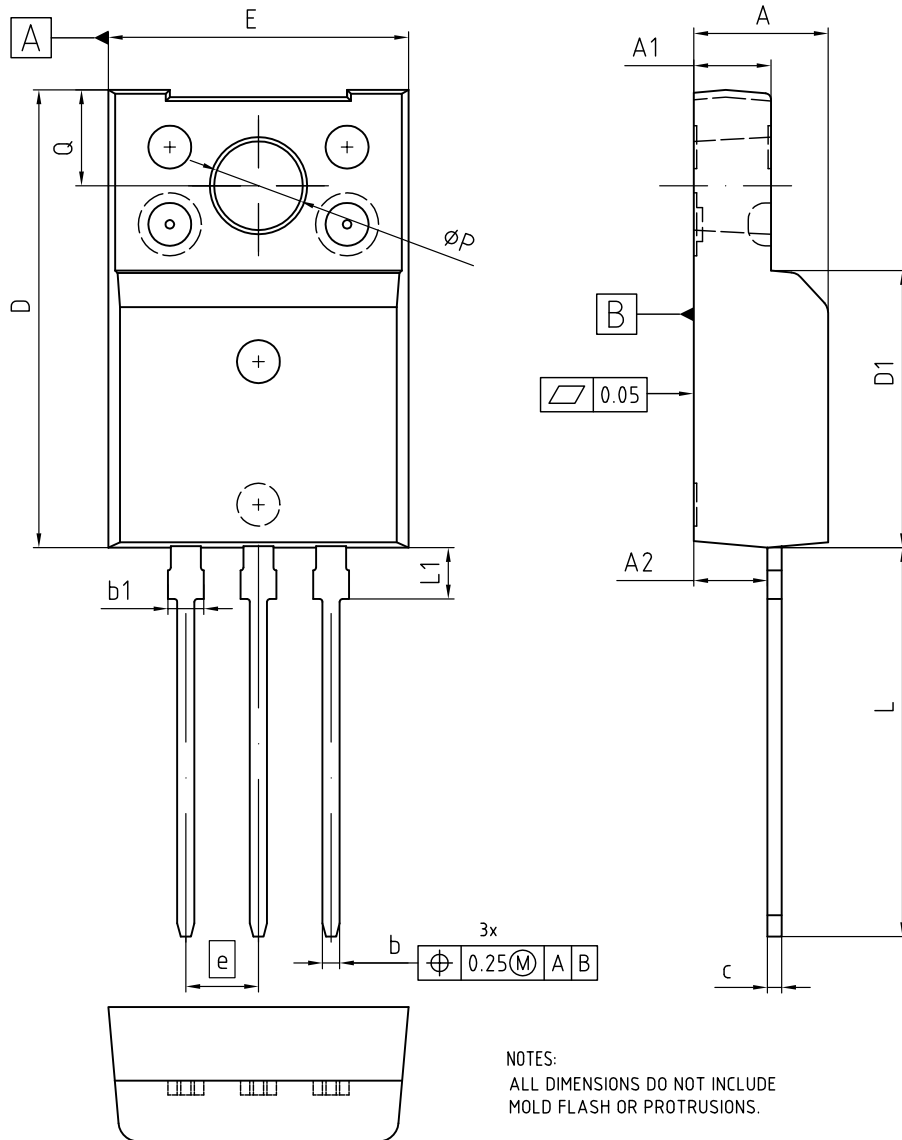
**Table 9 Switching times**



**Table 10 Unclamped inductive load**



**6 Package Outlines**



| DIMENSIONS | MILLIMETERS |       |
|------------|-------------|-------|
|            | MIN.        | MAX.  |
| A          | 4.60        | 4.80  |
| A1         | 2.60        | 2.80  |
| A2         | 2.47        | 2.67  |
| b          | 0.56        | 0.69  |
| b1         | 1.01        | 1.15  |
| c          | 0.46        | 0.59  |
| D          | 15.90       | 16.10 |
| D1         | 9.58        | 9.78  |
| E          | 10.40       | 10.60 |
| e          | 2.54        |       |
| N          | 3           |       |
| L          | 13.45       | 13.75 |
| L1         | 1.70        | 1.90  |
| phiP       | 3.00        | 3.20  |
| Q          | 3.25        | 3.45  |

|                                    |
|------------------------------------|
| <b>DOCUMENT NO.</b><br>Z8B00180155 |
| <b>REVISION</b><br>04              |
| <b>SCALE 5:1</b><br>0 1 2 3 4 5mm  |
| <b>EUROPEAN PROJECTION</b><br>     |
| <b>ISSUE DATE</b><br>07.11.2016    |

Figure 1 Outline PG-TO 220 FullPAK - Narrow Lead, dimensions in mm

## 7 Appendix A

Table 11 Related Links

- IFX CoolMOS P7 Webpage: [www.infineon.com](http://www.infineon.com)
- IFX CoolMOS P7 application note: [www.infineon.com](http://www.infineon.com)
- IFX CoolMOS P7 simulation model: [www.infineon.com](http://www.infineon.com)
- IFX Design tools: [www.infineon.com](http://www.infineon.com)

## Revision History

IPAN60R360P7S

Revision: 2019-02-26, Rev. 2.0

### Previous Revision

| Revision | Date       | Subjects (major changes since last revision) |
|----------|------------|--|
| 2.0      | 2019-02-26 | Release of final version                     |

#### Trademarks

All referenced product or service names and trademarks are the property of their respective owners.

#### We Listen to Your Comments

Any information within this document that you feel is wrong, unclear or missing at all? Your feedback will help us to continuously improve the quality of this document. Please send your proposal (including a reference to this document) to: [erratum@infineon.com](mailto:erratum@infineon.com)

#### Published by

Infineon Technologies AG  
81726 München, Germany  
© 2018 Infineon Technologies AG  
All Rights Reserved.

#### Legal Disclaimer

The information given in this document shall in no event be regarded as a guarantee of conditions or characteristics ("Beschaffungsgarantie").

With respect to any examples, hints or any typical values stated herein and/or any information regarding the application of the product, Infineon Technologies hereby disclaims any and all warranties and liabilities of any kind, including without limitation warranties of non-infringement of intellectual property rights of any third party.

In addition, any information given in this document is subject to customer's compliance with its obligations stated in this document and any applicable legal requirements, norms and standards concerning customer's products and any use of the product of Infineon Technologies in customer's applications.

The data contained in this document is exclusively intended for technically trained staff. It is the responsibility of customer's technical departments to evaluate the suitability of the product for the intended application and the completeness of the product information given in this document with respect to such application.

#### Information

For further information on technology, delivery terms and conditions and prices please contact your nearest Infineon Technologies Office ([www.infineon.com](http://www.infineon.com)).

#### Warnings

Due to technical requirements, components may contain dangerous substances. For information on the types in question, please contact the nearest Infineon Technologies Office.

The Infineon Technologies component described in this Data Sheet may be used in life-support devices or systems and/or automotive, aviation and aerospace applications or systems only with the express written approval of Infineon Technologies, if a failure of such components can reasonably be expected to cause the failure of that life-support, automotive, aviation and aerospace device or system or to affect the safety or effectiveness of that device or system. Life support devices or systems are intended to be implanted in the human body or to support and/or maintain and sustain and/or protect human life. If they fail, it is reasonable to assume that the health of the user or other persons may be endangered.

## X-ON Electronics

Largest Supplier of Electrical and Electronic Components

*Click to view similar products for [MOSFET](#) category:*

*Click to view products by [Infineon](#) manufacturer:*

Other Similar products are found below :

[614233C](#) [648584F](#) [IRFD120](#) [JANTX2N5237](#) [FCA20N60\\_F109](#) [FDZ595PZ](#) [2SK2545\(Q,T\)](#) [405094E](#) [423220D](#) [TPCC8103,L1Q\(CM](#)  
[MIC4420CM-TR](#) [VN1206L](#) [614234A](#) [715780A](#) [NTNS3166NZT5G](#) [SSM6J414TU,LF\(T](#) [751625C](#) [BUK954R8-60E](#) [GROUP A 5962-](#)  
[8877003PA](#) [NTE6400](#) [SQJ402EP-T1-GE3](#) [2SK2614\(TE16L1,Q\)](#) [2N7002KW-FAI](#) [DMN1017UCP3-7](#) [EFC2J004NUZTDG](#) [ECH8691-TL-W](#)  
[FCAB21350L1](#) [P85W28HP2F-7071](#) [DMN1053UCP4-7](#) [NTE221](#) [NTE222](#) [NTE2384](#) [NTE2903](#) [NTE2941](#) [NTE2945](#) [NTE2946](#) [NTE2960](#)  
[NTE2967](#) [NTE2969](#) [NTE2976](#) [NTE6400A](#) [NTE2910](#) [NTE2916](#) [NTE2956](#) [NTE2911](#) [DMN2080UCB4-7](#) [TK10A80W,S4X\(S](#)  
[SSM6P69NU,LF](#) [DMP22D4UFO-7B](#) [DMN1006UCA6-7](#)