

MOSFET

600V CoolMOS™ CE Power Transistor

CoolMOS™ is a revolutionary technology for high voltage power MOSFETs, designed according to the superjunction (SJ) principle and pioneered by Infineon Technologies. CoolMOS™ CE is a price-performance optimized platform enabling to target cost sensitive applications in Consumer and Lighting markets by still meeting highest efficiency standards. The new series provides all benefits of a fast switching Superjunction MOSFET while not sacrificing ease of use and offering the best cost down performance ratio available on the market.

Features

- Extremely low losses due to very low FOM $R_{DS(on)} \cdot Q_g$ and E_{oss}
- Very high commutation ruggedness
- Easy to use/drive
- Pb-free plating, Halogen free mold compound
- Qualified for standard grade applications

Applications

PFC stages, hard switching PWM stages and resonant switching stages for e.g. PC Silverbox, Adapter, LCD & PDP TV and indoor lighting.

Please note: Note1: For MOSFET paralleling the use of ferrite beads on the gate or separate totem poles is generally recommended.

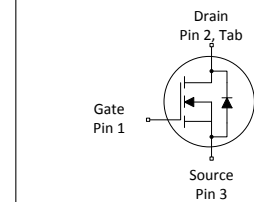
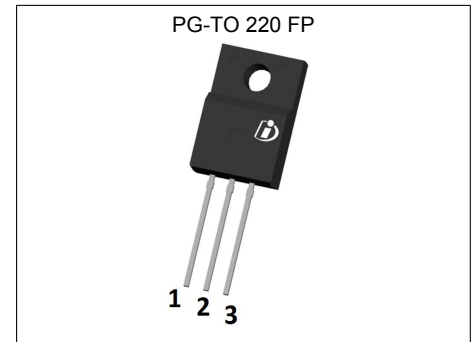

Table 1 Key Performance Parameters

| Parameter | Value | Unit |
|----------------------|-------|-----------|
| $V_{DS} @ T_{j,max}$ | 650 | V |
| $R_{DS(on),max}$ | 800 | $m\Omega$ |
| I_D | 8.4 | A |
| $Q_{g,typ}$ | 17.2 | nC |
| $I_{D,pulse}$ | 15.7 | A |
| $E_{oss@400V}$ | 1.6 | μJ |

| Type / Ordering Code | Package | Marking | Related Links |
|----------------------|---------------------------------|----------|----------------|
| IPAN60R800CE | PG-TO 220 FullPAK - Narrow Lead | 60S800CE | see Appendix A |

Table of Contents

| | |
|---|----|
| Description | 1 |
| Maximum ratings | 3 |
| Thermal characteristics | 3 |
| Electrical characteristics | 4 |
| Electrical characteristics diagrams | 6 |
| Test Circuits | 10 |
| Package Outlines | 11 |
| Appendix A | 12 |
| Revision History | 13 |
| Trademarks | 13 |
| Disclaimer | 13 |

1 Maximum ratings

at $T_j = 25^\circ\text{C}$, unless otherwise specified

Table 2 Maximum ratings

| Parameter | Symbol | Values | | | Unit | Note / Test Condition |
|--|---------------|--------|------|------------|------------------|---|
| | | Min. | Typ. | Max. | | |
| Continuous drain current ¹⁾ | I_D | - | - | 8.4 5.3 | A | $T_C=25^\circ\text{C}$ $T_C=100^\circ\text{C}$ |
| Pulsed drain current ²⁾ | $I_{D,pulse}$ | - | - | 15.7 | A | $T_C=25^\circ\text{C}$ |
| Avalanche energy, single pulse | E_{AS} | - | - | 72 | mJ | $I_D=1\text{A}$; $V_{DD}=50\text{V}$; see table 11 |
| Avalanche energy, repetitive | E_{AR} | - | - | 0.17 | mJ | $I_D=1\text{A}$; $V_{DD}=50\text{V}$; see table 11 |
| Avalanche current, repetitive | I_{AR} | - | - | 1.0 | A | - |
| MOSFET dv/dt ruggedness | dv/dt | - | - | 50 | V/ns | $V_{DS}=0\dots480\text{V}$ |
| Gate source voltage (static) | V_{GS} | -20 | - | 20 | V | static; |
| Gate source voltage (dynamic) | V_{GS} | -30 | - | 30 | V | AC ($f>1\text{ Hz}$) |
| Power dissipation (Non FullPAK) TO-252 | P_{tot} | - | - | 48 | W | $T_C=25^\circ\text{C}$ |
| Storage temperature | T_{stg} | -40 | - | 150 | $^\circ\text{C}$ | - |
| Operating junction temperature | T_j | -40 | - | 150 | $^\circ\text{C}$ | - |
| Continuous diode forward current | I_S | - | - | 5.9 | A | $T_C=25^\circ\text{C}$ |
| Diode pulse current ²⁾ | $I_{S,pulse}$ | - | - | 15.7 | A | $T_C=25^\circ\text{C}$ |
| Reverse diode dv/dt ³⁾ | dv/dt | - | - | 15 | V/ns | $V_{DS}=0\dots400\text{V}$, $I_{SD}\leq I_S$, $T_j=25^\circ\text{C}$ see table 9 |
| Maximum diode commutation speed | di/dt | - | - | 500 | A/ μs | $V_{DS}=0\dots400\text{V}$, $I_{SD}\leq I_S$, $T_j=25^\circ\text{C}$ see table 9 |
| Power dissipation (FullPAK) TO-220FP | P_{tot} | - | - | 27 | W | $T_C=25^\circ\text{C}$ |
| Mounting torque (FullPAK) TO-220FP | - | - | - | 50 | Ncm | M2.5 screws |
| Insulation withstand voltage for TO-220FP | V_{ISO} | - | - | 2500 | V | V_{rms} , $T_C=25^\circ\text{C}$, $t=1\text{min}$ |

2 Thermal characteristics

Table 3 Thermal characteristics (FullPAK) TO-220FP

| Parameter | Symbol | Values | | | Unit | Note / Test Condition |
|---|------------|--------|------|------|--------------------|-------------------------------------|
| | | Min. | Typ. | Max. | | |
| Thermal resistance, junction - case | R_{thJC} | - | - | 4.6 | $^\circ\text{C/W}$ | - |
| Thermal resistance, junction - ambient | R_{thJA} | - | - | 80 | $^\circ\text{C/W}$ | leaded |
| Soldering temperature, wavesoldering only allowed at leads | T_{sold} | - | - | 260 | $^\circ\text{C}$ | 1.6mm (0.063 in.) from case for 10s |

¹⁾ Limited by $T_{j,max}$. TO220 equivalent, Maximum duty cycle $D=0.50$

²⁾ Pulse width t_p limited by $T_{j,max}$

³⁾ Identical low side and high side switch with identical R_θ

3 Electrical characteristics
 at $T_j=25^\circ\text{C}$, unless otherwise specified

Table 4 Static characteristics

| Parameter | Symbol | Values | | | Unit | Note / Test Condition |
|----------------------------------|---------------|--------|------|------|----------|---|
| | | Min. | Typ. | Max. | | |
| Drain-source breakdown voltage | $V_{(BR)DSS}$ | 600 | - | - | V | $V_{GS}=0V, I_D=0.25mA$ |
| Gate threshold voltage | $V_{(GS)th}$ | 2.5 | 3.0 | 3.5 | V | $V_{DS}=V_{GS}, I_D=0.17mA$ |
| Zero gate voltage drain current | I_{DSS} | - | - | 1 | μA | $V_{DS}=600, V_{GS}=0V, T_j=25^\circ C$ $V_{DS}=600, V_{GS}=0V, T_j=150^\circ C$ |
| Gate-source leakage current | I_{GSS} | - | - | 100 | nA | $V_{GS}=20V, V_{DS}=0V$ |
| Drain-source on-state resistance | $R_{DS(on)}$ | - | 0.68 | 0.80 | Ω | $V_{GS}=10V, I_D=2A, T_j=25^\circ C$ $V_{GS}=10V, I_D=2A, T_j=150^\circ C$ |
| Gate resistance | R_G | - | 11 | - | Ω | $f=1MHz, \text{open drain}$ |

Table 5 Dynamic characteristics

| Parameter | Symbol | Values | | | Unit | Note / Test Condition |
|--|--------------|--------|------|------|------|--|
| | | Min. | Typ. | Max. | | |
| Input capacitance | C_{iss} | - | 373 | - | pF | $V_{GS}=0V, V_{DS}=100V, f=1MHz$ |
| Output capacitance | C_{oss} | - | 27 | - | pF | $V_{GS}=0V, V_{DS}=100V, f=1MHz$ |
| Effective output capacitance, energy related ¹⁾ | $C_{o(er)}$ | - | 18 | - | pF | $V_{GS}=0V, V_{DS}=0...480V$ |
| Effective output capacitance, time related ²⁾ | $C_{o(tr)}$ | - | 74 | - | pF | $I_D=\text{constant}, V_{GS}=0V, V_{DS}=0...480V$ |
| Turn-on delay time | $t_{d(on)}$ | - | 9 | - | ns | $V_{DD}=400V, V_{GS}=13V, I_D=2.5A,$ $R_G=6.8\Omega; \text{see table 10}$ |
| Rise time | t_r | - | 7 | - | ns | $V_{DD}=400V, V_{GS}=13V, I_D=2.5A,$ $R_G=6.8\Omega; \text{see table 10}$ |
| Turn-off delay time | $t_{d(off)}$ | - | 50 | - | ns | $V_{DD}=400V, V_{GS}=13V, I_D=2.5A,$ $R_G=6.8\Omega; \text{see table 10}$ |
| Fall time | t_f | - | 12 | - | ns | $V_{DD}=400V, V_{GS}=13V, I_D=2.5A,$ $R_G=6.8\Omega; \text{see table 10}$ |

Table 6 Gate charge characteristics

| Parameter | Symbol | Values | | | Unit | Note / Test Condition |
|-----------------------|---------------|--------|------|------|------|---|
| | | Min. | Typ. | Max. | | |
| Gate to source charge | Q_{GS} | - | 2 | - | nC | $V_{DD}=480V, I_D=2.5A, V_{GS}=0 \text{ to } 10V$ |
| Gate to drain charge | Q_{gd} | - | 8.9 | - | nC | $V_{DD}=480V, I_D=2.5A, V_{GS}=0 \text{ to } 10V$ |
| Gate charge total | Q_g | - | 17.2 | - | nC | $V_{DD}=480V, I_D=2.5A, V_{GS}=0 \text{ to } 10V$ |
| Gate plateau voltage | $V_{plateau}$ | - | 5.4 | - | V | $V_{DD}=480V, I_D=2.5A, V_{GS}=0 \text{ to } 10V$ |

¹⁾ $C_{o(er)}$ is a fixed capacitance that gives the same stored energy as C_{oss} while V_{DS} is rising from 0 to 80% $V_{(BR)DSS}$

²⁾ $C_{o(tr)}$ is a fixed capacitance that gives the same stored energy as C_{oss} while V_{DS} is rising from 0 to 80% $V_{(BR)DSS}$

Table 7 Reverse diode characteristics

| Parameter | Symbol | Values | | | Unit | Note / Test Condition |
|-------------------------------|-----------|--------|------|------|---------|---|
| | | Min. | Typ. | Max. | | |
| Diode forward voltage | V_{SD} | - | 0.9 | - | V | $V_{GS}=0V, I_F=2.5A, T_j=25^\circ C$ |
| Reverse recovery time | t_{rr} | - | 250 | - | ns | $V_R=400V, I_F=2.5A, di_F/dt=100A/\mu s$; see table 9 |
| Reverse recovery charge | Q_{rr} | - | 1.8 | - | μC | $V_R=400V, I_F=2.5A, di_F/dt=100A/\mu s$; see table 9 |
| Peak reverse recovery current | I_{rrm} | - | 16 | - | A | $V_R=400V, I_F=2.5A, di_F/dt=100A/\mu s$; see table 9 |

4 Electrical characteristics diagrams

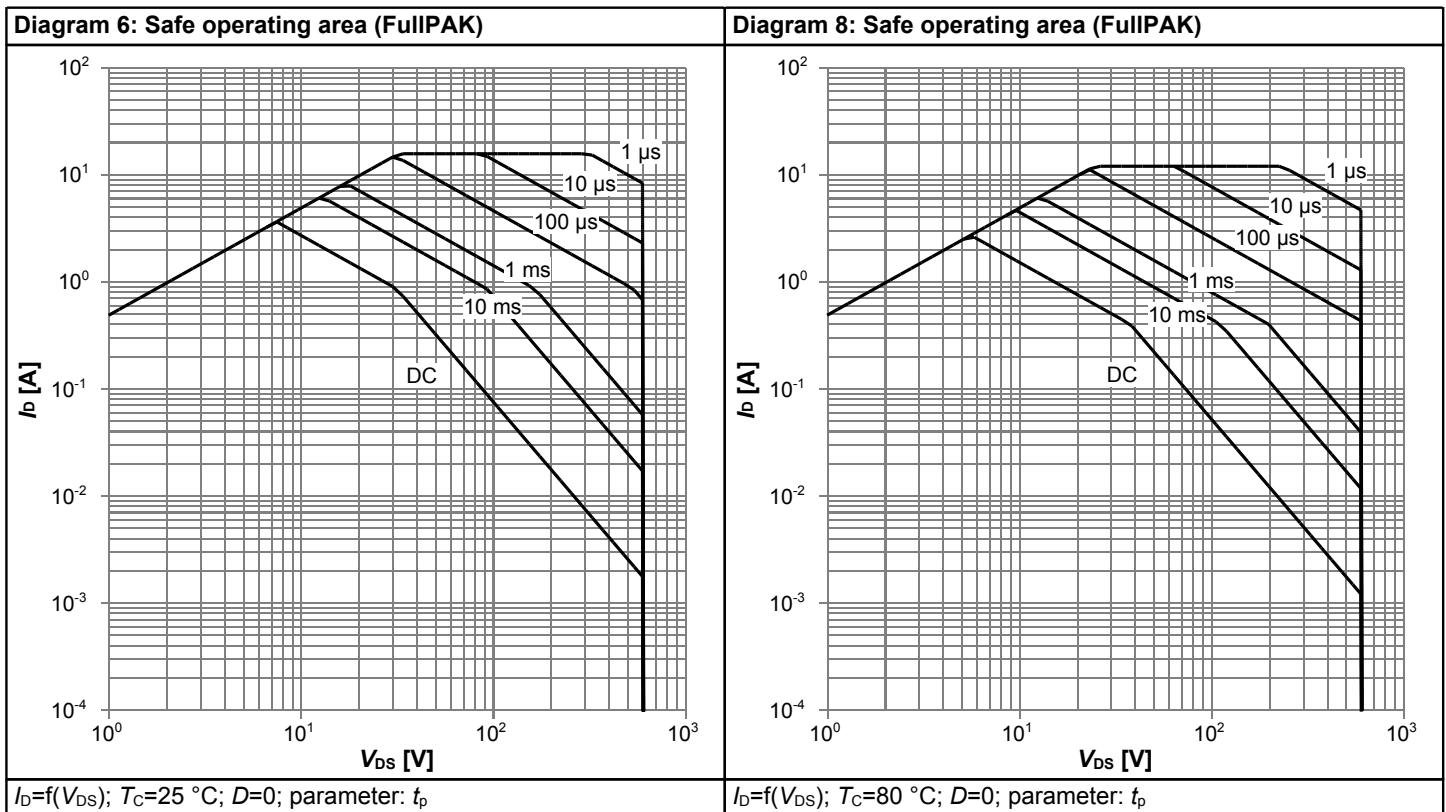
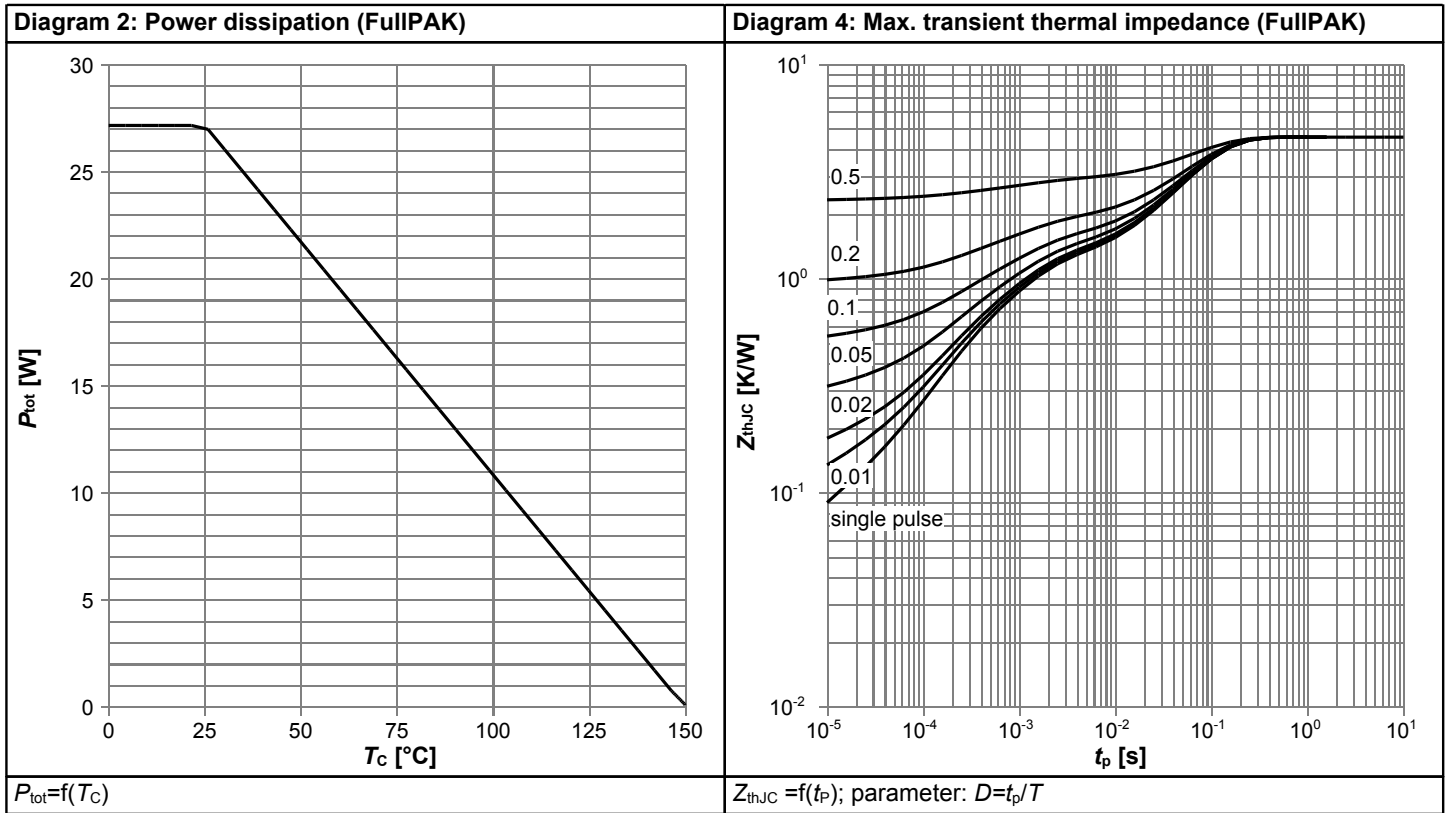
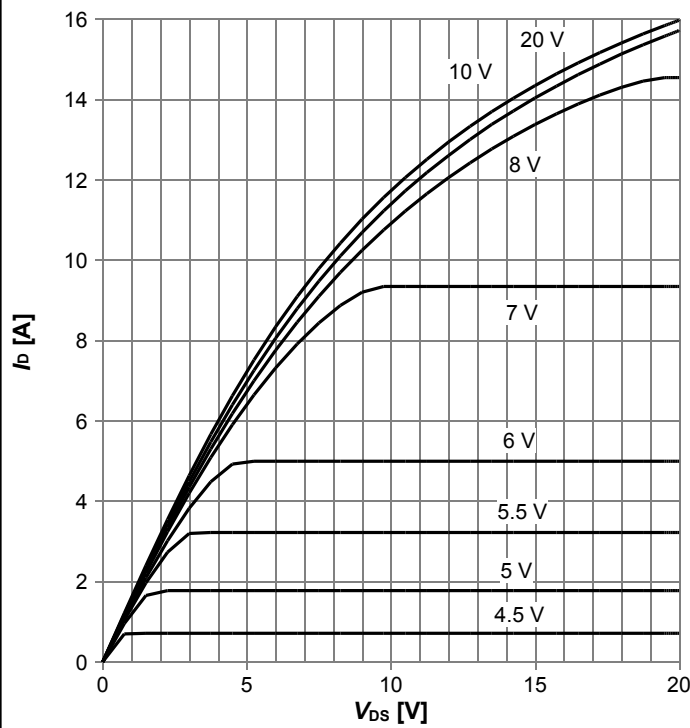
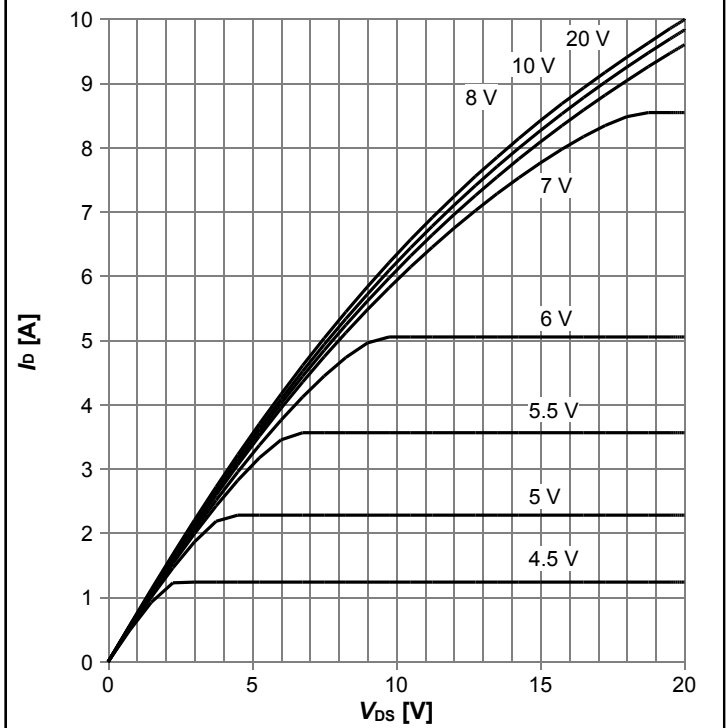

Diagram 9: Typ. output characteristics



$I_D=f(V_{DS})$; $T_j=25\text{ }^\circ\text{C}$; parameter: V_{GS}

Diagram 10: Typ. output characteristics



$I_D=f(V_{DS})$; $T_j=125\text{ }^\circ\text{C}$; parameter: V_{GS}

Diagram 11: Typ. drain-source on-state resistance

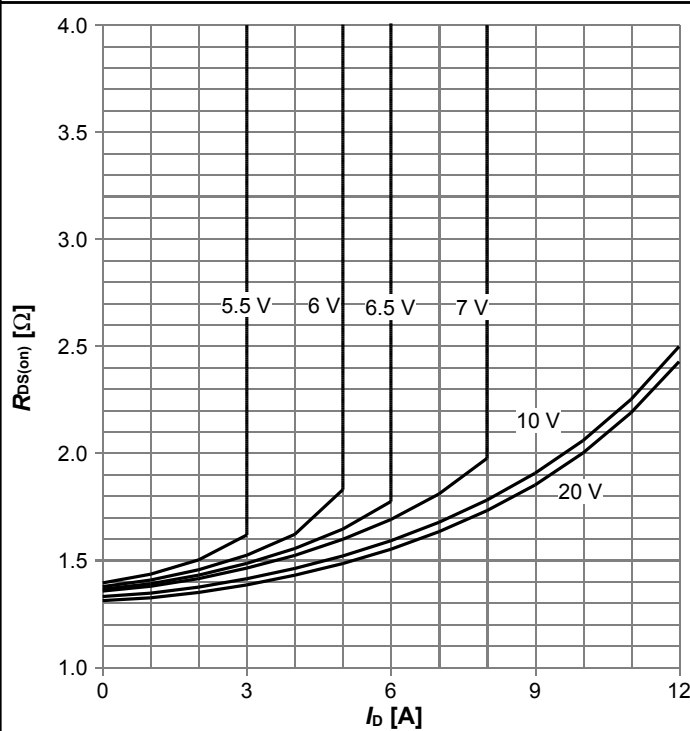

$R_{DS(on)}=f(I_D)$; $T_j=125\text{ }^\circ\text{C}$; parameter: V_{GS}

Diagram 12: Drain-source on-state resistance

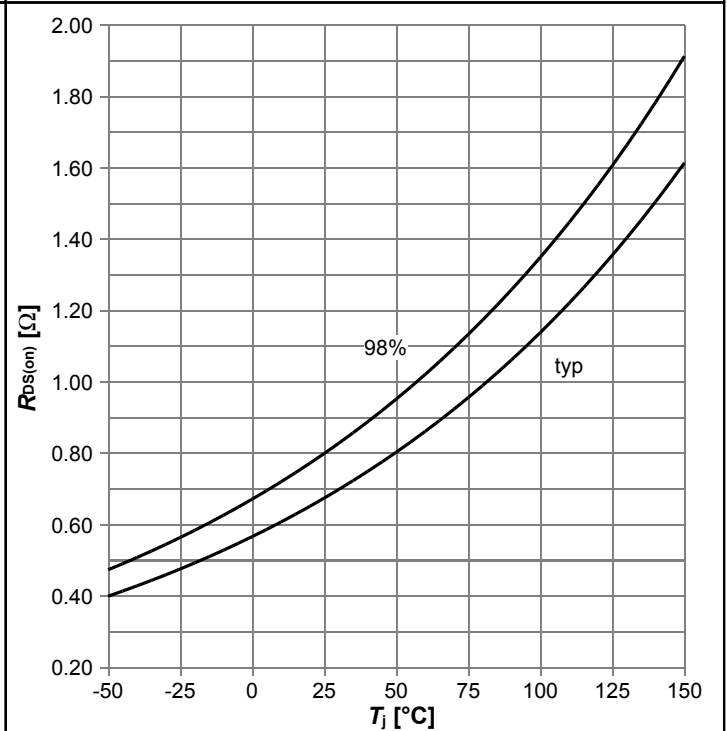

$R_{DS(on)}=f(T_j)$; $I_D=2.0\text{ A}$; $V_{GS}=10\text{ V}$

Diagram 13: Typ. transfer characteristics

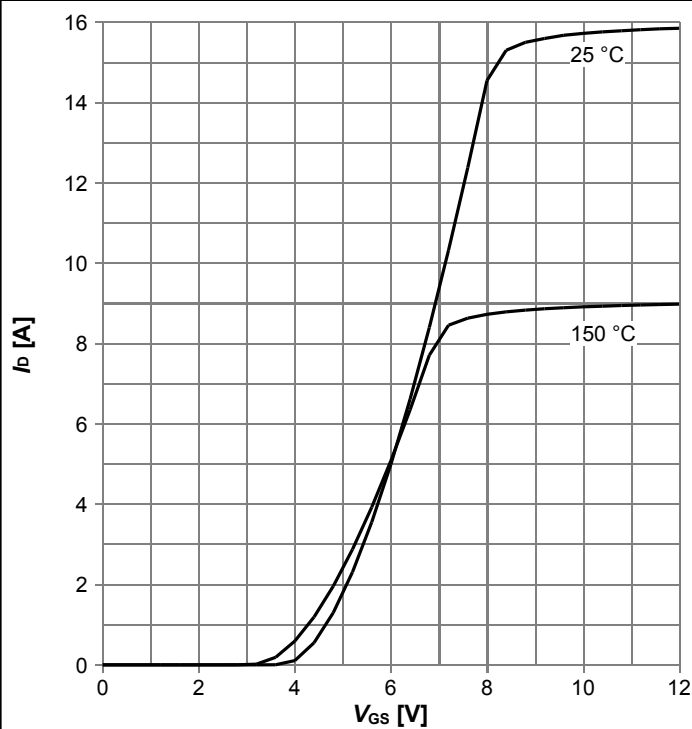

$I_D=f(V_{GS}); V_{DS}=20V$; parameter: T_j

Diagram 14: Typ. gate charge

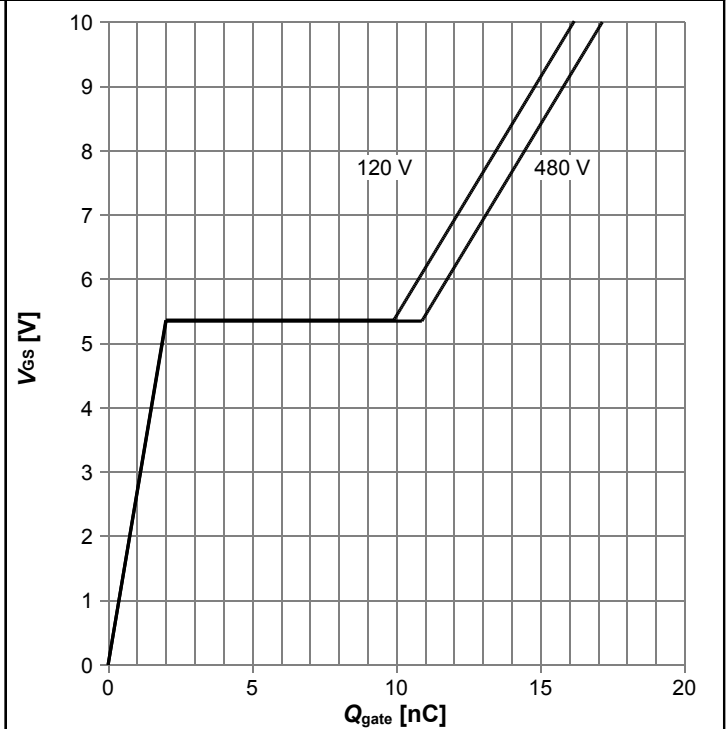

$V_{GS}=f(Q_{gate}); I_D=2.5 A$ pulsed; parameter: V_{DD}

Diagram 15: Forward characteristics of reverse diode

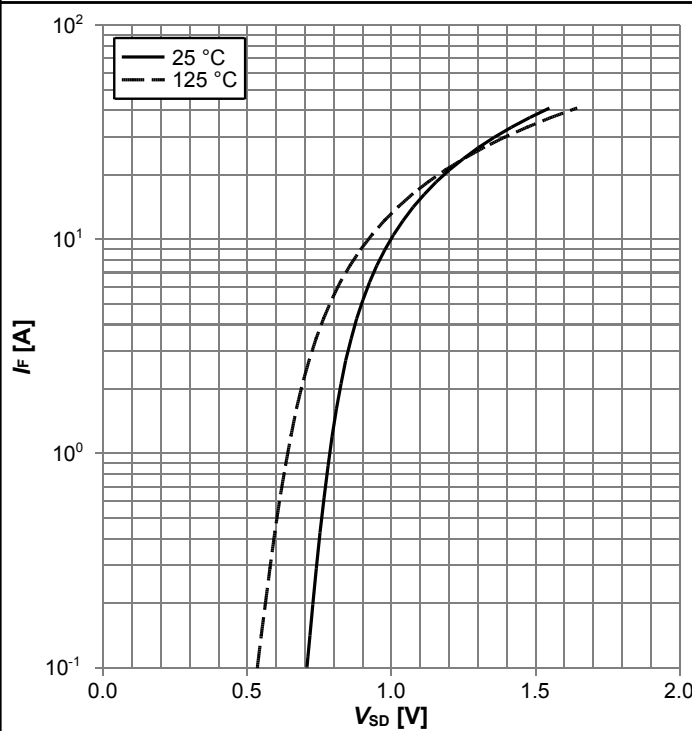

$I_F=f(V_{SD})$; parameter: T_j

Diagram 16: Avalanche energy

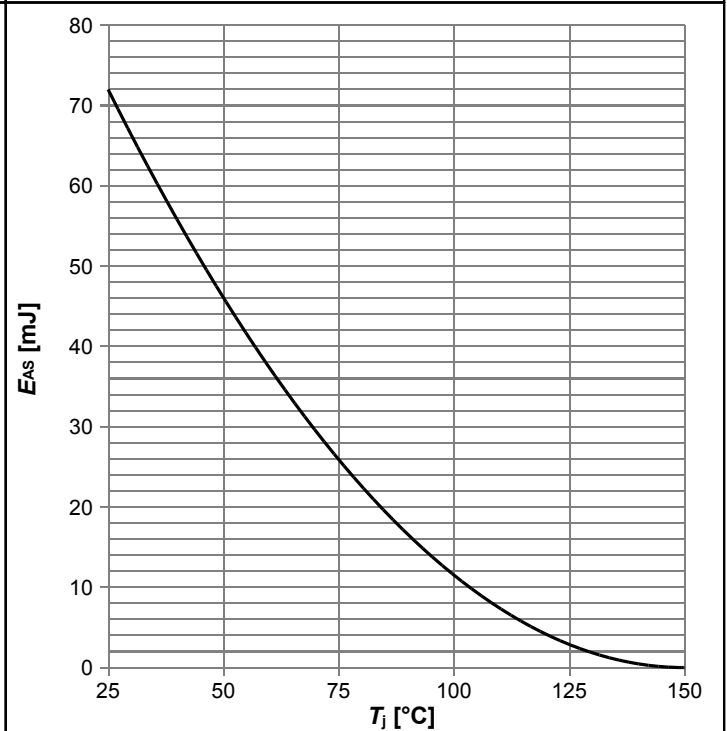

$E_{AS}=f(T_j); I_D=1.0 A; V_{DD}=50 V$

600V CoolMOS™ CE Power Transistor

IPAN60R800CE

Diagram 17: Drain-source breakdown voltage

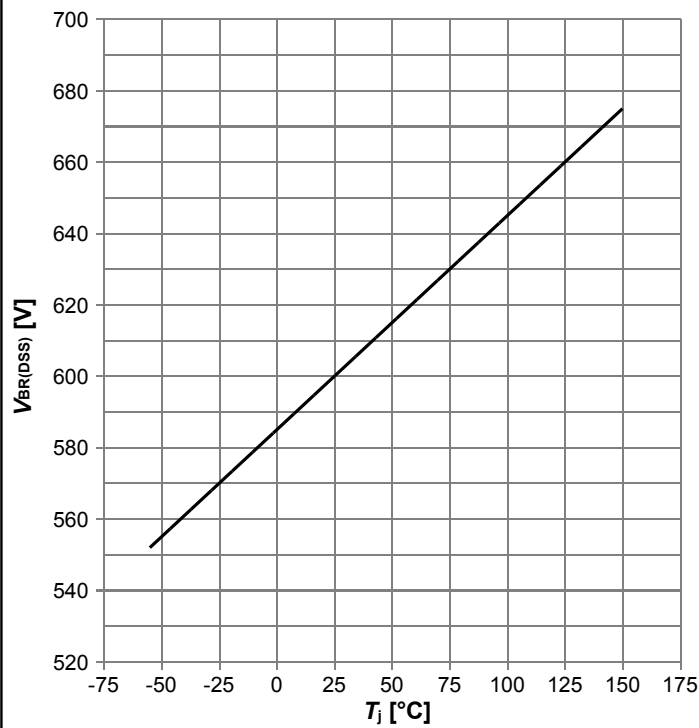

$V_{BR(DSS)}=f(T_j); I_D=0.25 \text{ mA}$

Diagram 18: Typ. capacitances

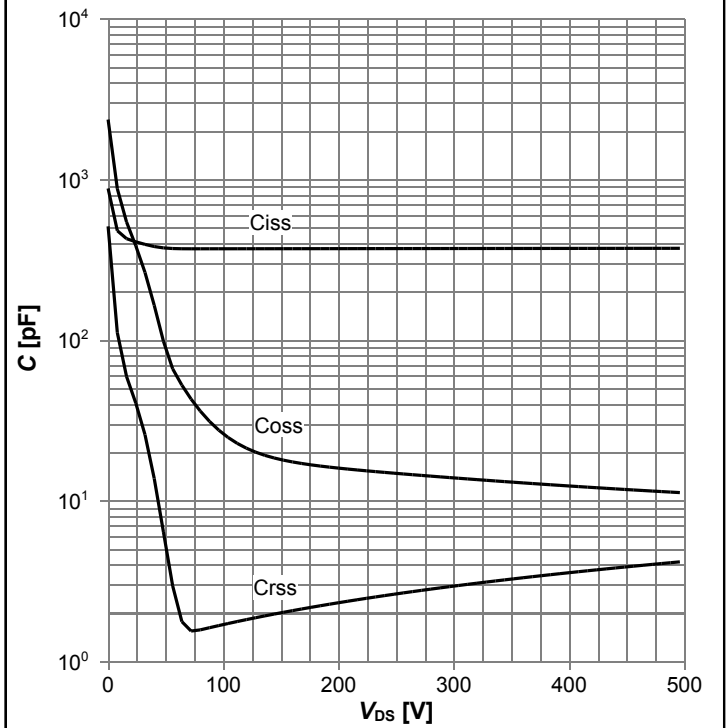

$C=f(V_{DS}); V_{GS}=0 \text{ V}; f=1 \text{ MHz}$

Diagram 19: Typ. Coss stored energy

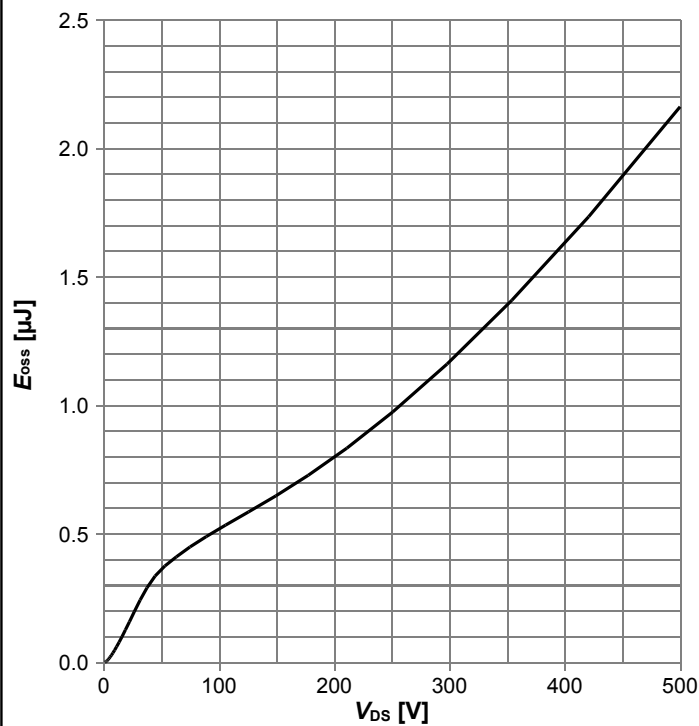

$E_{oss}=f(V_{DS})$

5 Test Circuits

Table 8 Diode characteristics

| Test circuit for diode characteristics | Diode recovery waveform |
|--|---|
| <p>$R_{g1} = R_{g2}$</p> | <p>$t_{tr} = t_F + t_S$ $Q_{tr} = Q_F + Q_S$</p> |

Table 9 Switching times

| Switching times test circuit for inductive load | Switching times waveform |
|---|--------------------------|
| | |

Table 10 Unclamped inductive load

| Unclamped inductive load test circuit | Unclamped inductive waveform |
|---------------------------------------|------------------------------|
| | |

6 Package Outlines

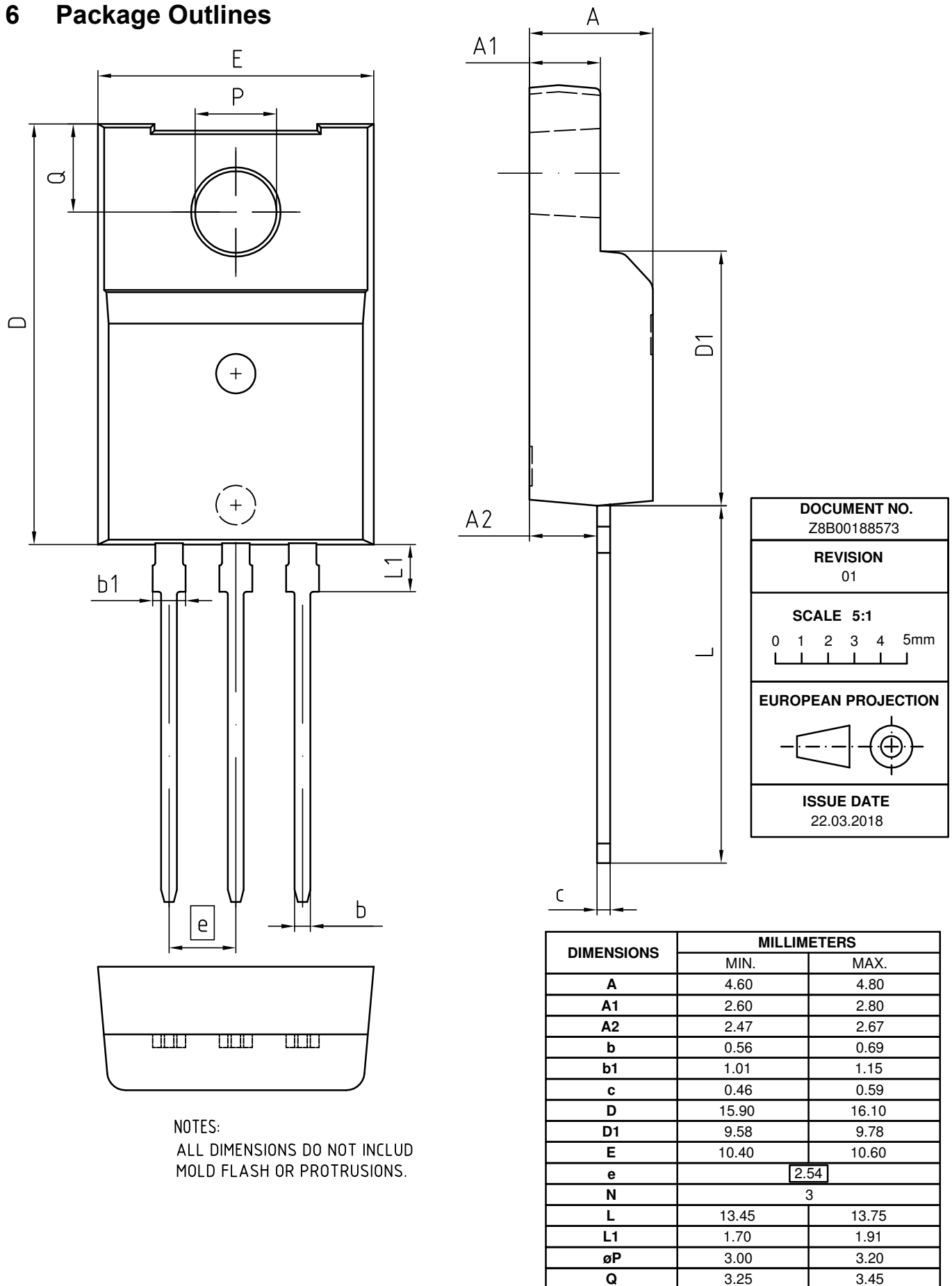

Figure 1 Outline PG-TO 220 FullPAK - Narrow Lead, dimensions in mm

7 Appendix A

Table 11 Related Links

- IFX CoolMOS™ CE Webpage: www.infineon.com
- IFX CoolMOS™ CE application note: www.infineon.com
- IFX CoolMOS™ CE simulation model: www.infineon.com
- IFX Design tools: www.infineon.com

Revision History

IPAN60R800CE

Revision: 2018-04-30, Rev. 2.2

Previous Revision

| Revision | Date | Subjects (major changes since last revision) |
|----------|------------|--|
| 2.1 | 2016-11-28 | Revised package drawing on page 11 |
| 2.2 | 2018-04-30 | Revised package drawing |

Trademarks of Infineon Technologies AG

AURIX™, C166™, CanPAK™, CIPOS™, CoolGaN™, CoolMOS™, CoolSET™, CoolSiC™, CORECONTROL™, CROSSAVE™, DAVE™, DI-POL™, DrBlade™, EasyPIM™, EconoBRIDGE™, EconoDUAL™, EconoPACK™, EconoPIM™, EiceDRIVER™, eupec™, FCOS™, HITFET™, HybridPACK™, Infineon™, ISOFACE™, IsoPACK™, i-Wafer™, MIPAQ™, ModSTACK™, my-d™, NovalithIC™, OmniTune™, OPTIGA™, OptiMOS™, ORIGA™, POWERCODE™, PRIMARION™, PrimePACK™, PrimeSTACK™, PROFET™, PRO-SIL™, RASIC™, REAL3™, ReverSave™, SatRIC™, SIEGET™, SIPMOS™, SmartLEWIS™, SOLID FLASH™, SPOC™, TEMPFET™, thinQ!™, TRENCHSTOP™, TriCore™.

Trademarks updated August 2015

Other Trademarks

All referenced product or service names and trademarks are the property of their respective owners.

We Listen to Your Comments

Any information within this document that you feel is wrong, unclear or missing at all? Your feedback will help us to continuously improve the quality of this document. Please send your proposal (including a reference to this document) to:

erratum@infineon.com

Published by
Infineon Technologies AG
81726 München, Germany
© 2018 Infineon Technologies AG
All Rights Reserved.

Legal Disclaimer

The information given in this document shall in no event be regarded as a guarantee of conditions or characteristics ("Beschaffenhheitsgarantie").

With respect to any examples, hints or any typical values stated herein and/or any information regarding the application of the product, Infineon Technologies hereby disclaims any and all warranties and liabilities of any kind, including without limitation warranties of non-infringement of intellectual property rights of any third party.

In addition, any information given in this document is subject to customer's compliance with its obligations stated in this document and any applicable legal requirements, norms and standards concerning customer's products and any use of the product of Infineon Technologies in customer's applications.

The data contained in this document is exclusively intended for technically trained staff. It is the responsibility of customer's technical departments to evaluate the suitability of the product for the intended application and the completeness of the product information given in this document with respect to such application.

Information

For further information on technology, delivery terms and conditions and prices please contact your nearest Infineon Technologies Office (www.infineon.com).

Warnings

Due to technical requirements, components may contain dangerous substances. For information on the types in question, please contact the nearest Infineon Technologies Office.

The Infineon Technologies component described in this Data Sheet may be used in life-support devices or systems and/or automotive, aviation and aerospace applications or systems only with the express written approval of Infineon Technologies, if a failure of such components can reasonably be expected to cause the failure of that life-support, automotive, aviation and aerospace device or system or to affect the safety or effectiveness of that device or system. Life support devices or systems are intended to be implanted in the human body or to support and/or maintain and sustain and/or protect human life. If they fail, it is reasonable to assume that the health of the user or other persons may be endangered.

X-ON Electronics

Largest Supplier of Electrical and Electronic Components

Click to view similar products for [MOSFET](#) category:

Click to view products by [Infineon](#) manufacturer:

Other Similar products are found below :

[614233C](#) [648584F](#) [IRFD120](#) [JANTX2N5237](#) [FCA20N60_F109](#) [FDZ595PZ](#) [2SK2545\(Q,T\)](#) [405094E](#) [423220D](#) [TPCC8103,L1Q\(CM](#)
[MIC4420CM-TR](#) [VN1206L](#) [614234A](#) [715780A](#) [NTNS3166NZT5G](#) [SSM6J414TU,LF\(T](#) [751625C](#) [BUK954R8-60E](#) [GROUP A 5962-](#)
[8877003PA](#) [NTE6400](#) [SQJ402EP-T1-GE3](#) [2SK2614\(TE16L1,Q\)](#) [2N7002KW-FAI](#) [DMN1017UCP3-7](#) [EFC2J004NUZTDG](#) [ECH8691-TL-W](#)
[FCAB21350L1](#) [P85W28HP2F-7071](#) [DMN1053UCP4-7](#) [NTE221](#) [NTE222](#) [NTE2384](#) [NTE2903](#) [NTE2941](#) [NTE2945](#) [NTE2946](#) [NTE2960](#)
[NTE2967](#) [NTE2969](#) [NTE2976](#) [NTE6400A](#) [NTE2910](#) [NTE2916](#) [NTE2956](#) [NTE2911](#) [DMN2080UCB4-7](#) [TK10A80W,S4X\(S](#)
[SSM6P69NU,LF](#) [DMP22D4UFO-7B](#) [DMN1006UCA6-7](#)