

MOSFET

OptiMOS™ 5 Power-Transistor, 100 V

Features

- Ideal for high frequency switching and sync. rec.
- Excellent gate charge x $R_{DS(on)}$ product (FOM)
- Very low on-resistance $R_{DS(on)}$
- N-channel, normal level
- 100% avalanche tested
- Pb-free plating; RoHS compliant
- Halogen-free according to IEC61249-2-21

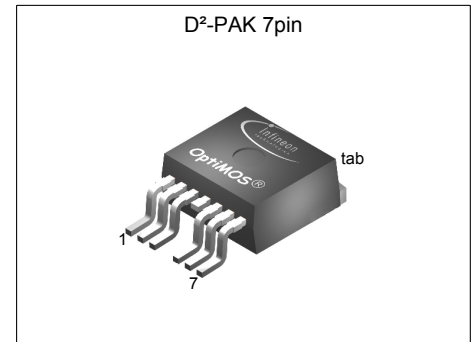

Product validation

Fully qualified according to JEDEC for Industrial Applications

Table 1 Key Performance Parameters

Parameter	Value	Unit
V_{DS}	100	V
$R_{DS(on),max}$	1.7	m Ω
I_D	273	A
Q_{oss}	213	nC
$Q_G(0V..10V)$	168	nC

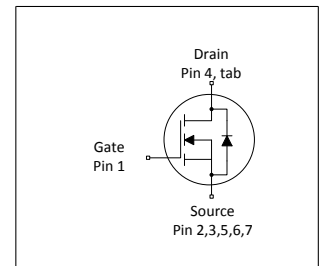

Type / Ordering Code	Package	Marking	Related Links
IPB017N10N5	PG-TO 263-7	017N10N5	-

Table of Contents

Description	1
Maximum ratings	3
Thermal characteristics	3
Electrical characteristics	4
Electrical characteristics diagrams	6
Package Outlines	10
Revision History	11
Trademarks	11
Disclaimer	11

1 Maximum ratings

at $T_A=25\text{ °C}$, unless otherwise specified

Table 2 Maximum ratings

Parameter	Symbol	Values			Unit	Note / Test Condition
		Min.	Typ.	Max.		
Continuous drain current	I_D	-	-	273 209	A	$T_C=25\text{ °C}$ $T_C=100\text{ °C}$
Pulsed drain current ¹⁾	$I_{D,pulse}$	-	-	1092	A	$T_C=25\text{ °C}$
Avalanche energy, single pulse	E_{AS}	-	-	1166	mJ	$I_D=100\text{ A}$, $R_{GS}=25\text{ }\Omega$
Gate source voltage	V_{GS}	-20	-	20	V	-
Power dissipation	P_{tot}	-	-	375	W	$T_C=25\text{ °C}$
Operating and storage temperature	T_j , T_{stg}	-55	-	175	°C	IEC climatic category; DIN IEC 68-1: 55/175/56

2 Thermal characteristics

Table 3 Thermal characteristics

Parameter	Symbol	Values			Unit	Note / Test Condition
		Min.	Typ.	Max.		
Thermal resistance, junction - case	R_{thJC}	-	0.3	0.4	K/W	-
Thermal resistance, junction - ambient, minimal footprint	R_{thJA}	-	-	62	K/W	-
Thermal resistance, junction - ambient, 6 cm ² cooling area ²⁾	R_{thJA}	-	-	40	K/W	-
Soldering temperature and reflow soldering is allowed	T_{sold}	-	-	260	°C	reflow MSL1

¹⁾ see Diagram 3

²⁾ Device on 40 mm x 40 mm x 1.5 mm epoxy PCB FR4 with 6 cm² (one layer, 70 µm thick) copper area for drain connection. PCB is vertical in still air.

3 Electrical characteristics

at $T_j=25\text{ °C}$, unless otherwise specified

Table 4 Static characteristics

Parameter	Symbol	Values			Unit	Note / Test Condition
		Min.	Typ.	Max.		
Drain-source breakdown voltage	$V_{(BR)DSS}$	100	-	-	V	$V_{GS}=0\text{ V}$, $I_D=1\text{ mA}$
Gate threshold voltage	$V_{GS(th)}$	2.2	3	3.8	V	$V_{DS}=V_{GS}$, $I_D=279\text{ }\mu\text{A}$
Zero gate voltage drain current	I_{DSS}	-	0.1 10	5 100	μA	$V_{DS}=100\text{ V}$, $V_{GS}=0\text{ V}$, $T_j=25\text{ °C}$ $V_{DS}=100\text{ V}$, $V_{GS}=0\text{ V}$, $T_j=125\text{ °C}$
Gate-source leakage current	I_{GSS}	-	1	100	nA	$V_{GS}=20\text{ V}$, $V_{DS}=0\text{ V}$
Drain-source on-state resistance	$R_{DS(on)}$	-	1.5 1.7	1.7 2.2	m Ω	$V_{GS}=10\text{ V}$, $I_D=100\text{ A}$ $V_{GS}=6\text{ V}$, $I_D=50\text{ A}$
Gate resistance ¹⁾	R_G	-	1.3	2.0	Ω	-
Transconductance	g_{fs}	132	264	-	S	$ V_{DS} >2 I_D R_{DS(on)max}$, $I_D=100\text{ A}$

Table 5 Dynamic characteristics¹⁾

Parameter	Symbol	Values			Unit	Note / Test Condition
		Min.	Typ.	Max.		
Input capacitance	C_{iss}	-	12000	15600	pF	$V_{GS}=0\text{ V}$, $V_{DS}=50\text{ V}$, $f=1\text{ MHz}$
Output capacitance	C_{oss}	-	1810	2353	pF	$V_{GS}=0\text{ V}$, $V_{DS}=50\text{ V}$, $f=1\text{ MHz}$
Reverse transfer capacitance	C_{rss}	-	80	140	pF	$V_{GS}=0\text{ V}$, $V_{DS}=50\text{ V}$, $f=1\text{ MHz}$
Turn-on delay time	$t_{d(on)}$	-	33	-	ns	$V_{DD}=50\text{ V}$, $V_{GS}=10\text{ V}$, $I_D=100\text{ A}$, $R_{G,ext}=1.6\text{ }\Omega$
Rise time	t_r	-	23	-	ns	$V_{DD}=50\text{ V}$, $V_{GS}=10\text{ V}$, $I_D=100\text{ A}$, $R_{G,ext}=1.6\text{ }\Omega$
Turn-off delay time	$t_{d(off)}$	-	80	-	ns	$V_{DD}=50\text{ V}$, $V_{GS}=10\text{ V}$, $I_D=100\text{ A}$, $R_{G,ext}=1.6\text{ }\Omega$
Fall time	t_f	-	27	-	ns	$V_{DD}=50\text{ V}$, $V_{GS}=10\text{ V}$, $I_D=100\text{ A}$, $R_{G,ext}=1.6\text{ }\Omega$

Table 6 Gate charge characteristics²⁾

Parameter	Symbol	Values			Unit	Note / Test Condition
		Min.	Typ.	Max.		
Gate to source charge	Q_{gs}	-	53	-	nC	$V_{DD}=50\text{ V}$, $I_D=100\text{ A}$, $V_{GS}=0\text{ to }10\text{ V}$
Gate to drain charge ¹⁾	Q_{gd}	-	34	51	nC	$V_{DD}=50\text{ V}$, $I_D=100\text{ A}$, $V_{GS}=0\text{ to }10\text{ V}$
Switching charge	Q_{sw}	-	51	-	nC	$V_{DD}=50\text{ V}$, $I_D=100\text{ A}$, $V_{GS}=0\text{ to }10\text{ V}$
Gate charge total ¹⁾	Q_g	-	168	210	nC	$V_{DD}=50\text{ V}$, $I_D=100\text{ A}$, $V_{GS}=0\text{ to }10\text{ V}$
Gate plateau voltage	$V_{plateau}$	-	4.4	-	V	$V_{DD}=50\text{ V}$, $I_D=100\text{ A}$, $V_{GS}=0\text{ to }10\text{ V}$
Output charge ¹⁾	Q_{oss}	-	213	283	nC	$V_{DD}=50\text{ V}$, $V_{GS}=0\text{ V}$

¹⁾ Defined by design. Not subject to production test.

²⁾ See, gate charge waveforms, for parameter definition.

Table 7 Reverse diode

Parameter	Symbol	Values			Unit	Note / Test Condition
		Min.	Typ.	Max.		
Diode continuous forward current	I_S	-	-	241	A	$T_C=25\text{ °C}$
Diode pulse current	$I_{S,pulse}$	-	-	1092	A	$T_C=25\text{ °C}$
Diode forward voltage	V_{SD}	-	0.9	1.2	V	$V_{GS}=0\text{ V}, I_F=100\text{ A}, T_j=25\text{ °C}$
Reverse recovery time ¹⁾	t_{rr}	-	88	176	ns	$V_R=50\text{ V}, I_F=100\text{ A}, di_F/dt=100\text{ A}/\mu\text{s}$
Reverse recovery charge ¹⁾	Q_{rr}	-	235	470	nC	$V_R=50\text{ V}, I_F=100\text{ A}, di_F/dt=100\text{ A}/\mu\text{s}$

¹⁾ Defined by design. Not subject to production test.

4 Electrical characteristics diagrams

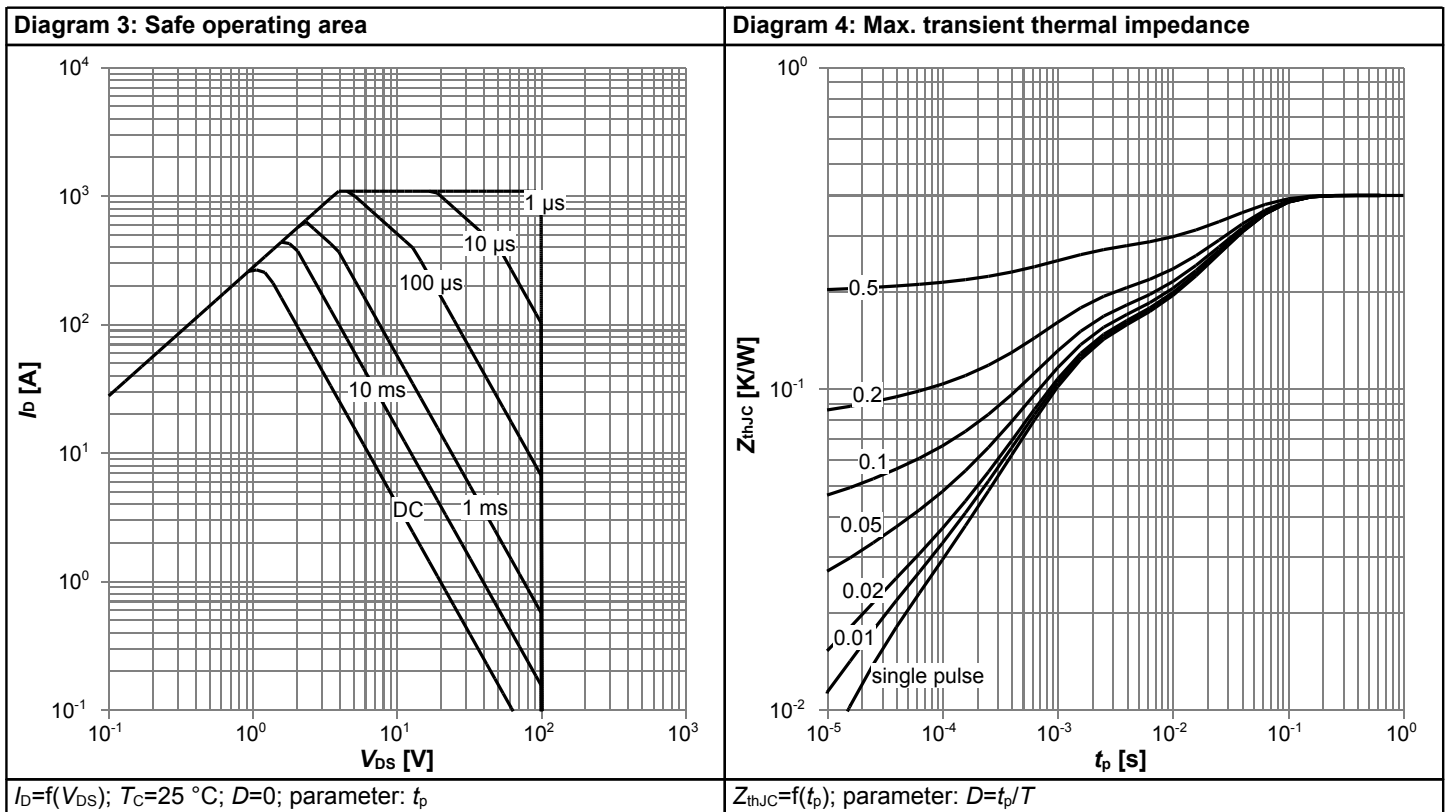
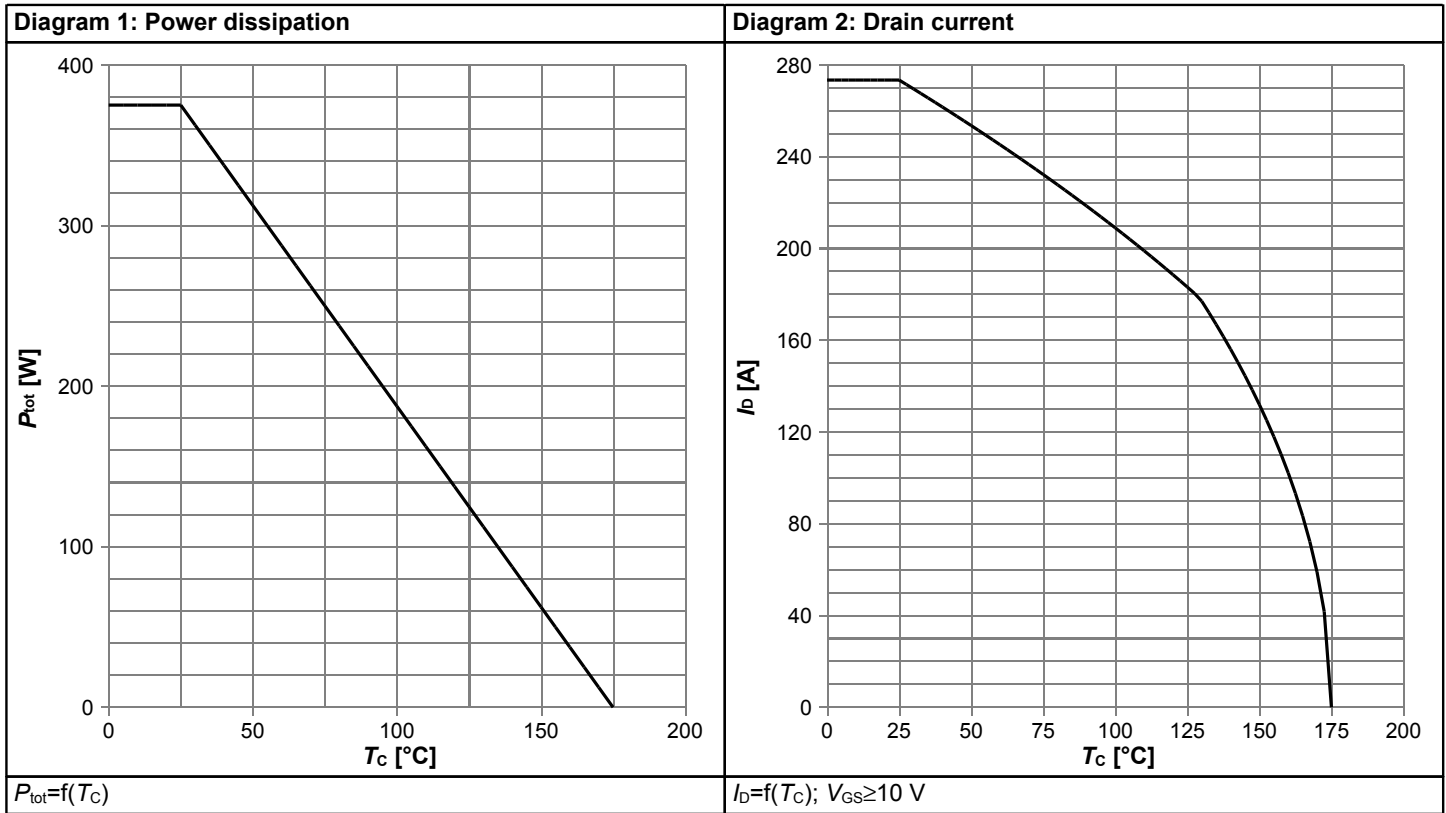
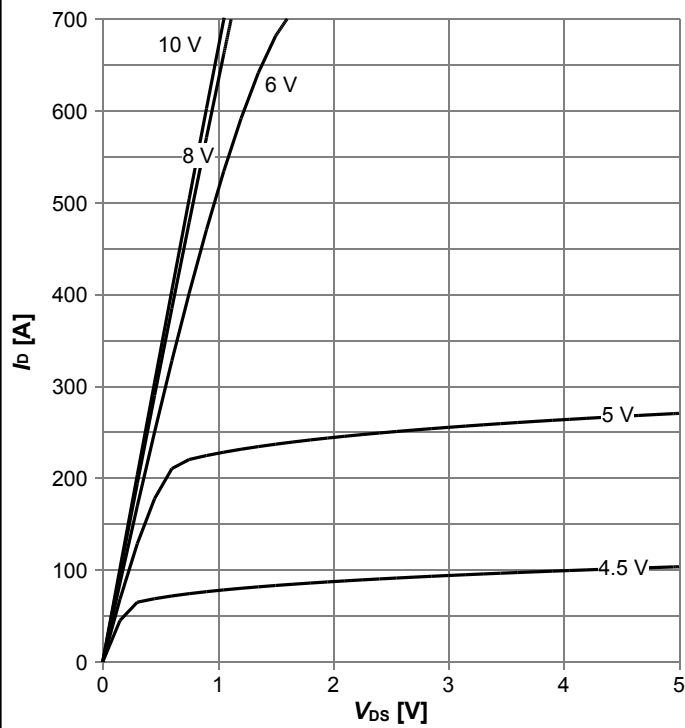
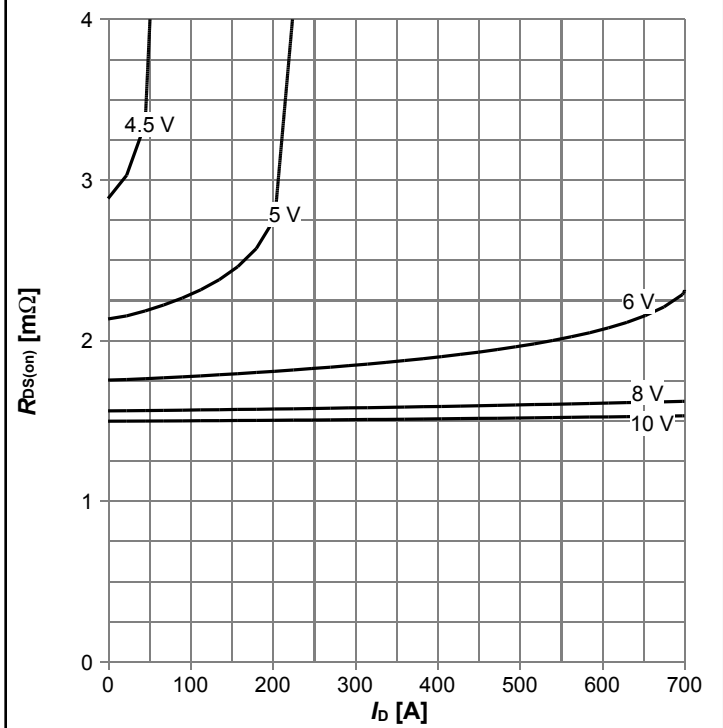

Diagram 5: Typ. output characteristics



$I_D=f(V_{DS})$; $T_j=25\text{ }^\circ\text{C}$; parameter: V_{GS}

Diagram 6: Typ. drain-source on resistance



$R_{DS(on)}=f(I_D)$; $T_j=25\text{ }^\circ\text{C}$; parameter: V_{GS}

Diagram 7: Typ. transfer characteristics

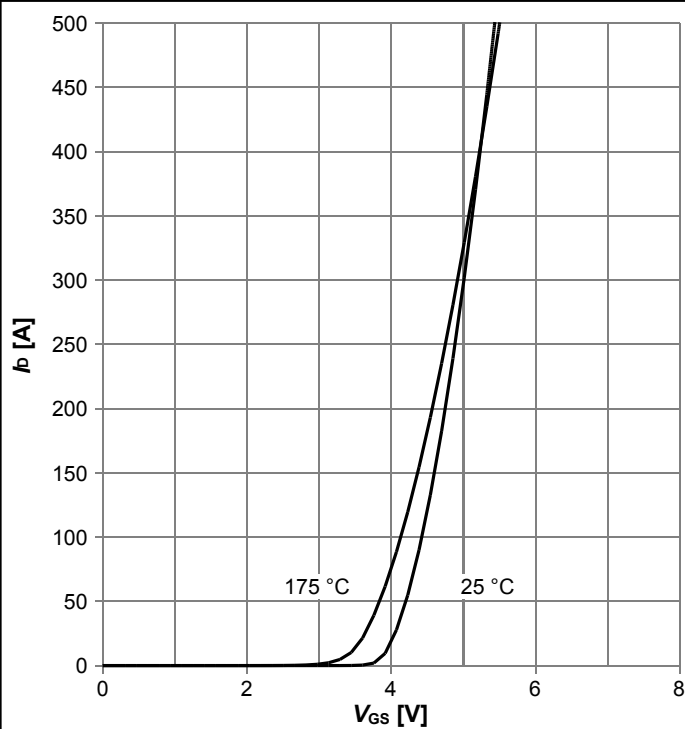

$I_D=f(V_{GS})$; $|V_{DS}|>2|I_D|R_{DS(on)max}$; parameter: T_j

Diagram 8: Typ. forward transconductance

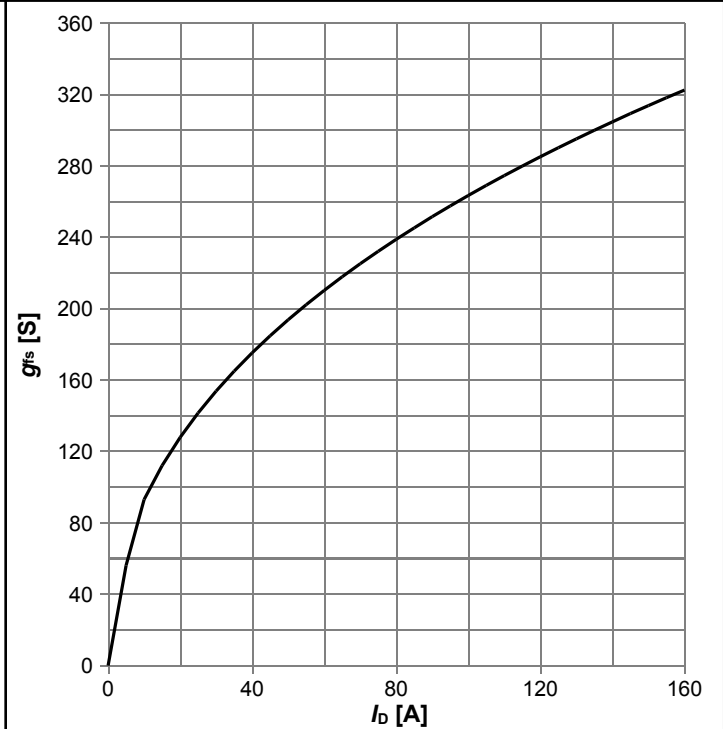

$g_{fs}=f(I_D)$; $T_j=25\text{ }^\circ\text{C}$

Diagram 9: Drain-source on-state resistance

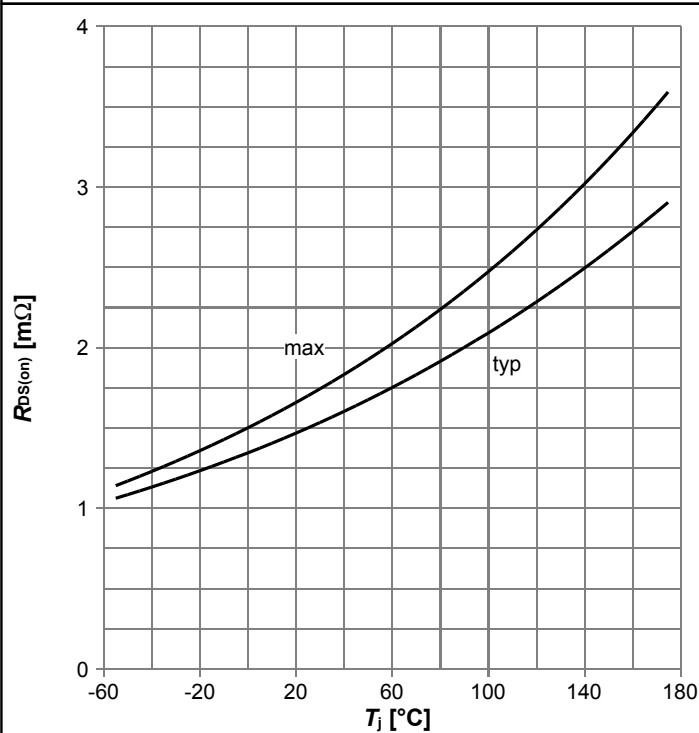

$R_{DS(on)}=f(T_j)$; $I_D=100\text{ A}$; $V_{GS}=10\text{ V}$

Diagram 10: Typ. gate threshold voltage

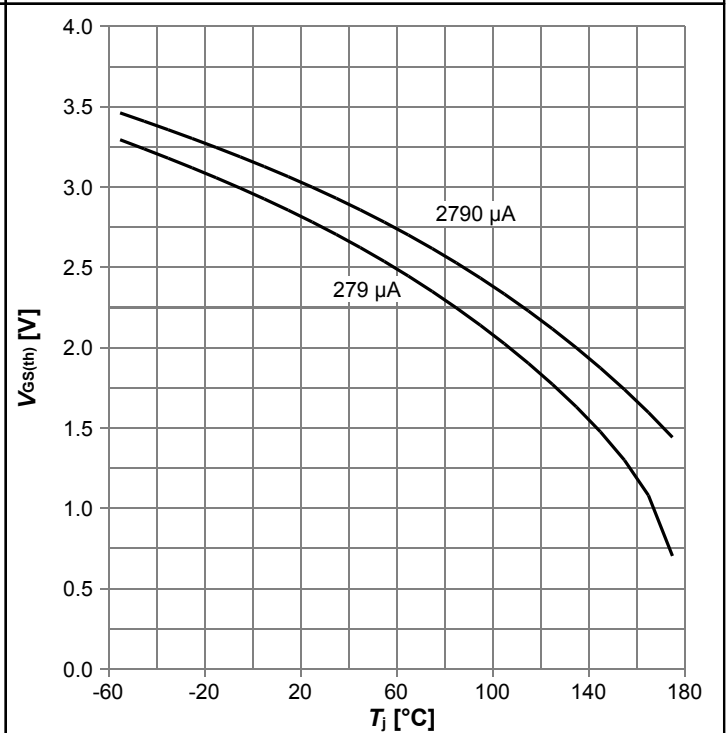

$V_{GS(th)}=f(T_j)$; $V_{GS}=V_{DS}$; parameter: I_D

Diagram 11: Typ. capacitances

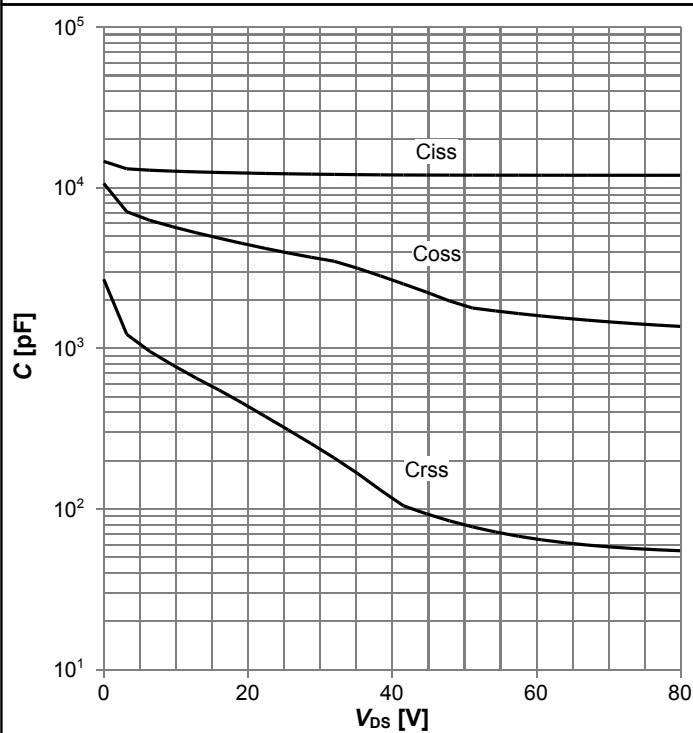

$C=f(V_{DS})$; $V_{GS}=0\text{ V}$; $f=1\text{ MHz}$

Diagram 12: Forward characteristics of reverse diode

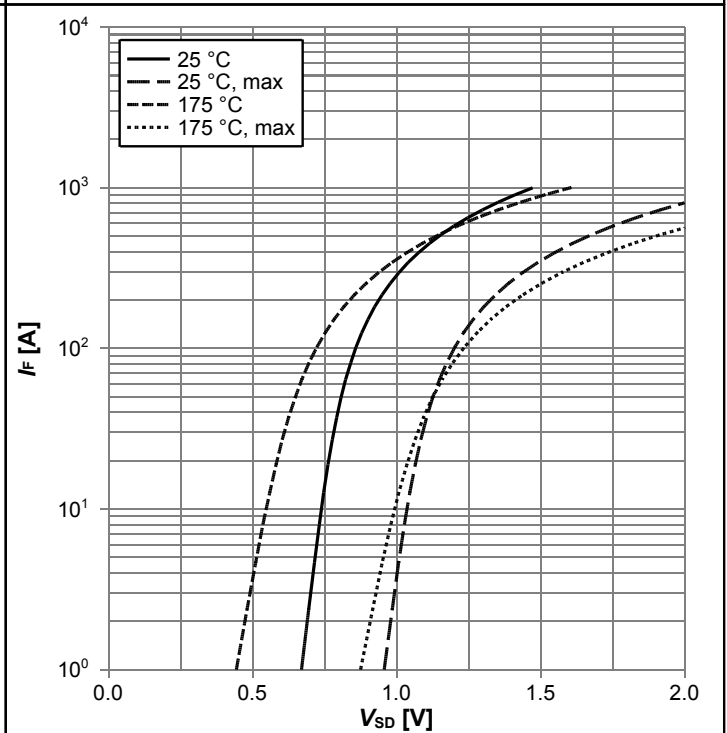

$I_F=f(V_{SD})$; parameter: T_j

Diagram 13: Avalanche characteristics

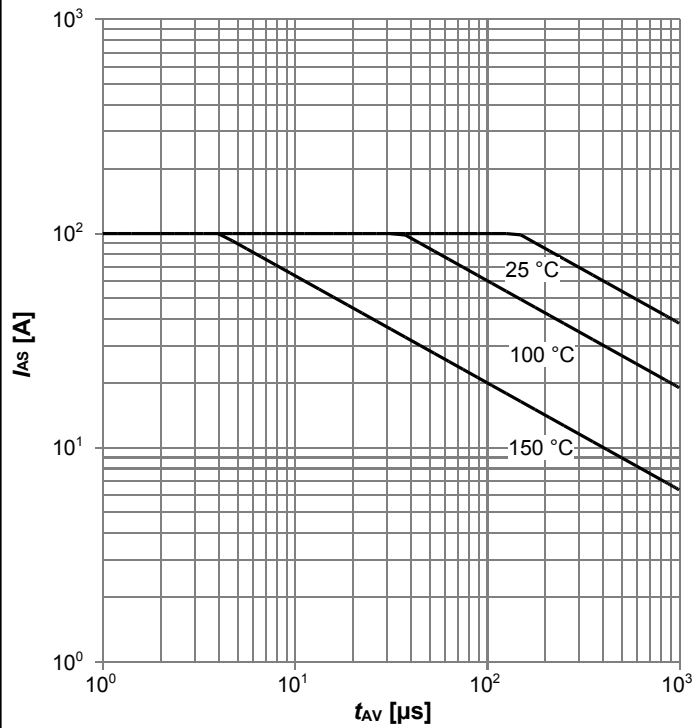

$I_{AS}=f(t_{AV}); R_{GS}=25 \Omega$; parameter: $T_{j(start)}$

Diagram 14: Typ. gate charge

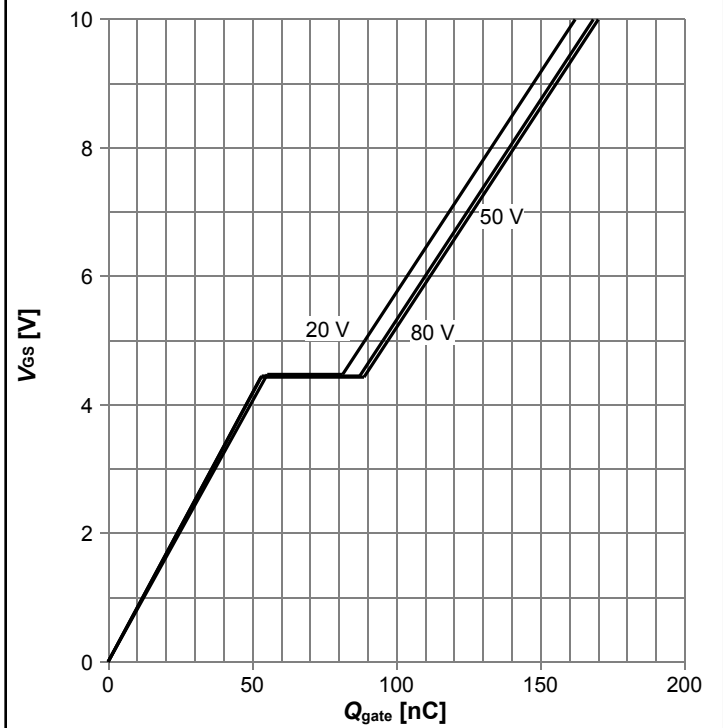

$V_{GS}=f(Q_{gate}); I_D=100$ A pulsed; parameter: V_{DD}

Diagram 15: Drain-source breakdown voltage

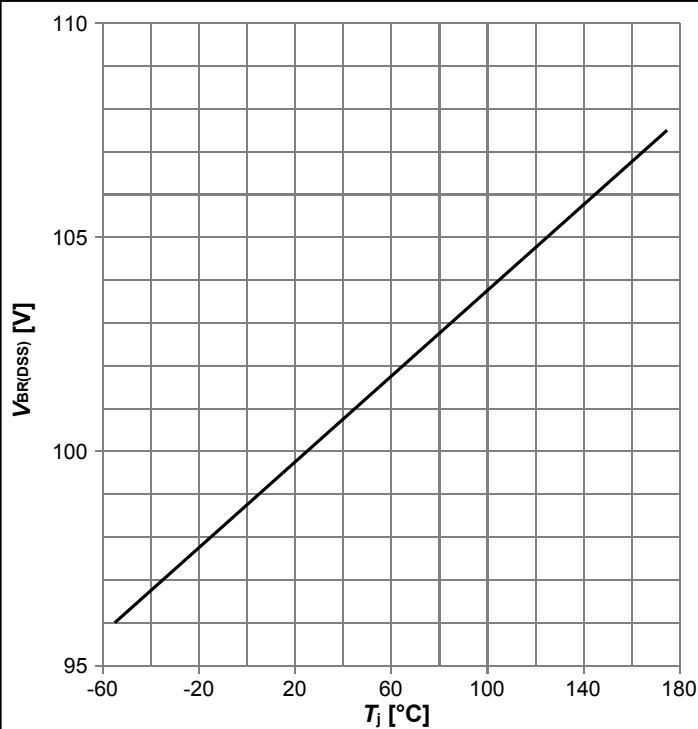

$V_{BR(DSS)}=f(T_j); I_D=1$ mA

Diagram Gate charge waveforms



5 Package Outlines

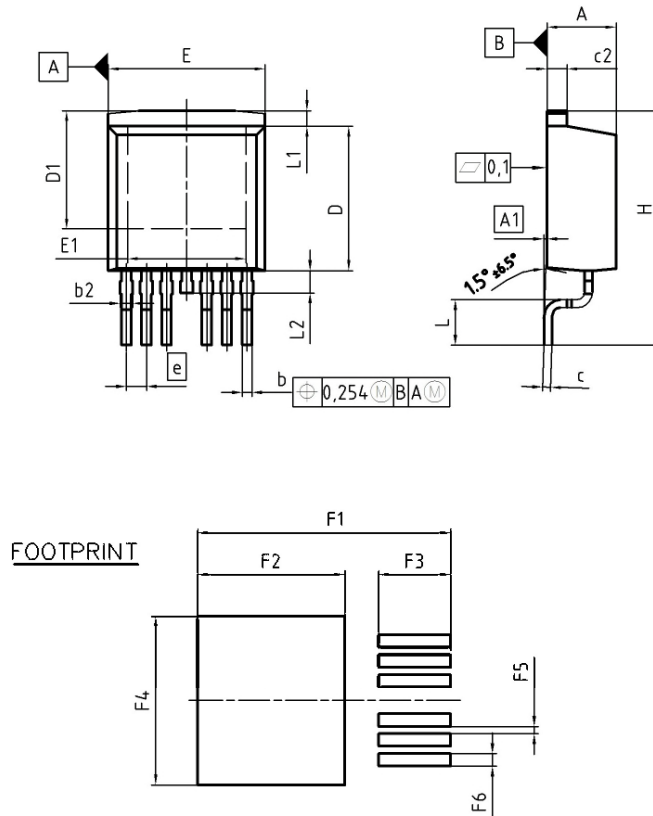

DIM	MILLIMETERS		INCHES	
	MIN	MAX	MIN	MAX
A	4.30	4.57	0.169	0.180
A1	0.00	0.25	0.000	0.010
b	0.50	0.70	0.020	0.028
b2	0.50	1.00	0.020	0.039
c	0.33	0.65	0.013	0.026
c2	1.17	1.40	0.046	0.055
D	8.51	9.45	0.335	0.372
D1	6.90	7.90	0.272	0.311
E	9.80	10.31	0.386	0.406
E1	6.50	8.60	0.256	0.339
e	1.27		0.050	
N	6		6	
H	14.61	15.88	0.575	0.625
L	2.29	3.00	0.090	0.118
L1	0.70	1.60	0.028	0.063
L2	1.00	1.78	0.039	0.070
F1	16.05	16.25	0.632	0.640
F2	9.30	9.50	0.366	0.374
F3	4.50	4.70	0.177	0.185
F4	10.70	10.90	0.421	0.429
F5	0.37	0.57	0.015	0.022
F6	0.70	0.90	0.028	0.035

DOCUMENT NO.
Z8B00134765

SCALE

EUROPEAN PROJECTION

ISSUE DATE
05-11-2007

REVISION
01

Figure 1 Outline PG-TO 263-7, dimensions in mm/inches

Revision History

IPB017N10N5

Revision: 2019-11-13, Rev. 2.5

Previous Revision

Revision	Date	Subjects (major changes since last revision)
2.0	2014-12-17	Release of final version
2.1	2015-02-09	Reduce active area by 0.7%
2.2	2015-10-15	Update package outline
2.3	2016-09-23	Update Avalanche Energy
2.4	2019-03-05	Update product current
2.5	2019-11-13	Update SOA Diagram

Trademarks

All referenced product or service names and trademarks are the property of their respective owners.

We Listen to Your Comments

Any information within this document that you feel is wrong, unclear or missing at all? Your feedback will help us to continuously improve the quality of this document. Please send your proposal (including a reference to this document) to:

erratum@infineon.com

Published by

Infineon Technologies AG
81726 München, Germany
© 2019 Infineon Technologies AG
All Rights Reserved.

Legal Disclaimer

The information given in this document shall in no event be regarded as a guarantee of conditions or characteristics ("Beschaffenheitsgarantie").

With respect to any examples, hints or any typical values stated herein and/or any information regarding the application of the product, Infineon Technologies hereby disclaims any and all warranties and liabilities of any kind, including without limitation warranties of non-infringement of intellectual property rights of any third party.

In addition, any information given in this document is subject to customer's compliance with its obligations stated in this document and any applicable legal requirements, norms and standards concerning customer's products and any use of the product of Infineon Technologies in customer's applications.

The data contained in this document is exclusively intended for technically trained staff. It is the responsibility of customer's technical departments to evaluate the suitability of the product for the intended application and the completeness of the product information given in this document with respect to such application.

Information

For further information on technology, delivery terms and conditions and prices please contact your nearest Infineon Technologies Office (www.infineon.com).

Warnings

Due to technical requirements, components may contain dangerous substances. For information on the types in question, please contact the nearest Infineon Technologies Office.

The Infineon Technologies component described in this Data Sheet may be used in life-support devices or systems and/or automotive, aviation and aerospace applications or systems only with the express written approval of Infineon Technologies, if a failure of such components can reasonably be expected to cause the failure of that life-support, automotive, aviation and aerospace device or system or to affect the safety or effectiveness of that device or system. Life support devices or systems are intended to be implanted in the human body or to support and/or maintain and sustain and/or protect human life. If they fail, it is reasonable to assume that the health of the user or other persons may be endangered.

X-ON Electronics

Largest Supplier of Electrical and Electronic Components

Click to view similar products for [MOSFET](#) category:

Click to view products by [Infineon](#) manufacturer:

Other Similar products are found below :

[614233C](#) [648584F](#) [IRFD120](#) [JANTX2N5237](#) [FCA20N60_F109](#) [FDZ595PZ](#) [2SK2545\(Q,T\)](#) [405094E](#) [423220D](#) [TPCC8103,L1Q\(CM](#)
[MIC4420CM-TR](#) [VN1206L](#) [614234A](#) [715780A](#) [NTNS3166NZT5G](#) [SSM6J414TU,LF\(T](#) [751625C](#) [BUK954R8-60E](#) [GROUP A 5962-](#)
[8877003PA](#) [NTE6400](#) [SQJ402EP-T1-GE3](#) [2SK2614\(TE16L1,Q\)](#) [2N7002KW-FAI](#) [DMN1017UCP3-7](#) [EFC2J004NUZTDG](#) [ECH8691-TL-W](#)
[FCAB21350L1](#) [P85W28HP2F-7071](#) [DMN1053UCP4-7](#) [NTE221](#) [NTE222](#) [NTE2384](#) [NTE2903](#) [NTE2941](#) [NTE2945](#) [NTE2946](#) [NTE2960](#)
[NTE2967](#) [NTE2969](#) [NTE2976](#) [NTE6400A](#) [NTE2910](#) [NTE2916](#) [NTE2956](#) [NTE2911](#) [DMN2080UCB4-7](#) [TK10A80W,S4X\(S](#)
[SSM6P69NU,LF](#) [DMP22D4UFO-7B](#) [DMN1006UCA6-7](#)