

MOSFET

800V CoolMOS™ P7 Power Device

The latest 800V CoolMOS™ P7 series sets a new benchmark in 800V super junction technologies and combines best-in-class performance with state of the art ease-of-use, resulting from Infineon's over 18 years pioneering super junction technology innovation.

Features

- Best-in-class FOM $R_{DS(on)} * E_{oss}$; reduced Q_g , C_{iss} , and C_{oss}
- Best-in-class DPAK $R_{DS(on)}$
- Best-in-class $V_{(GS)th}$ of 3V and smallest $V_{(GS)th}$ variation of $\pm 0.5V$
- Integrated Zener Diode ESD protection
- Fully optimized portfolio

Benefits

- Best-in-class performance
- Enabling higher power density designs, BOM savings and lower assembly costs
- Easy to drive and to parallel
- Better production yield by reducing ESD related failures
- Less production issues and reduced field returns
- Easy to select right parts for fine tuning of designs

Potential applications

Recommended for hard and soft switching flyback topologies for LED Lighting, low power Chargers and Adapters, Audio, AUX power and Industrial power. Also suitable for PFC stage in Consumer applications and Solar.

Product validation

Fully qualified according to JEDEC for Industrial Applications

Please note: For MOSFET paralleling the use of ferrite beads on the gate or separate totem poles is generally recommended.

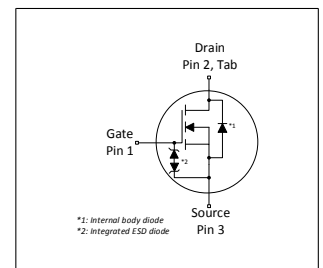
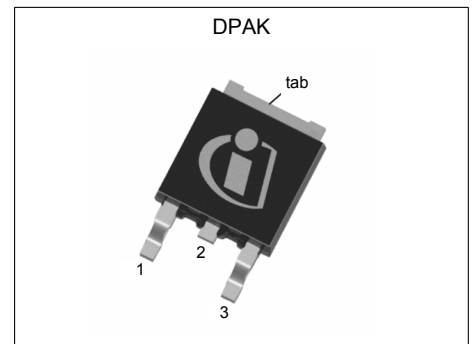

RoHS

Table 1 Key Performance Parameters

Parameter	Value	Unit
$V_{DS} @ T_J=25^\circ C$	800	V
$R_{DS(on),max}$	0.75	Ω
$Q_{g,typ}$	17	nC
I_D	7	A
$E_{oss} @ 500V$	1.6	μJ
$V_{GS(th),typ}$	3	V
ESD class (HBM)	2	-

Type / Ordering Code	Package	Marking	Related Links
IPD80R750P7	PG-TO252-3	80R750P7	see Appendix A

Table of Contents

Description	1
Maximum ratings	3
Thermal characteristics	3
Electrical characteristics	4
Electrical characteristics diagrams	6
Test Circuits	10
Package Outlines	11
Appendix A	12
Revision History	13
Trademarks	13
Disclaimer	13

1 Maximum ratings

at $T_j = 25^\circ\text{C}$, unless otherwise specified

Table 2 Maximum ratings

Parameter	Symbol	Values			Unit	Note / Test Condition
		Min.	Typ.	Max.		
Continuous drain current ¹⁾	I_D	-	-	7 4.6	A	$T_C=25^\circ\text{C}$ $T_C=100^\circ\text{C}$
Pulsed drain current ²⁾	$I_{D,pulse}$	-	-	17	A	$T_C=25^\circ\text{C}$
Avalanche energy, single pulse	E_{AS}	-	-	16	mJ	$I_D=1.1\text{A}$; $V_{DD}=50\text{V}$
Avalanche energy, repetitive	E_{AR}	-	-	0.14	mJ	$I_D=1.1\text{A}$; $V_{DD}=50\text{V}$
Avalanche current, repetitive	I_{AR}	-	-	1.1	A	-
MOSFET dv/dt ruggedness	dv/dt	-	-	100	V/ns	$V_{DS}=0$ to 400V
Gate source voltage	V_{GS}	-20 -30	-	20 30	V	static; AC ($f>1$ Hz)
Power dissipation	P_{tot}	-	-	51	W	$T_C=25^\circ\text{C}$
Operating and storage temperature	T_j, T_{stg}	-55	-	150	$^\circ\text{C}$	-
Continuous diode forward current	I_S	-	-	5.1	A	$T_C=25^\circ\text{C}$
Diode pulse current ²⁾	$I_{S,pulse}$	-	-	17	A	$T_C=25^\circ\text{C}$
Reverse diode dv/dt ³⁾	dv/dt	-	-	1	V/ns	$V_{DS}=0$ to 400V, $I_{SD}\leq 1.4\text{A}$, $T_j=25^\circ\text{C}$
Maximum diode commutation speed ³⁾	di/dt	-	-	50	A/ μs	$V_{DS}=0$ to 400V, $I_{SD}\leq 1.4\text{A}$, $T_j=25^\circ\text{C}$

2 Thermal characteristics

Table 3 Thermal characteristics

Parameter	Symbol	Values			Unit	Note / Test Condition
		Min.	Typ.	Max.		
Thermal resistance, junction - case	R_{thJC}	-	-	2.4	$^\circ\text{C/W}$	-
Thermal resistance, junction - ambient	R_{thJA}	-	-	62	$^\circ\text{C/W}$	Device on PCB, minimal footprint
Thermal resistance, junction - ambient for SMD version	R_{thJA}	-	35	45	$^\circ\text{C/W}$	Device on 40mm*40mm*1.5mm epoxy PCB FR4 with 6cm ² (one layer 70 μm thickness) copper area for drain connection and cooling. PCB is vertical without air stream cooling.
Soldering temperature, wave- & reflow soldering allowed	T_{sold}	-	-	260	$^\circ\text{C}$	reflow MSL1

1) Limited by $T_{j,max}$. Maximum duty cycle $D=0.5$

2) Pulse width t_p limited by $T_{j,max}$

3) $V_{DClink}=400\text{V}$; $V_{DS,peak}<V_{(BR)DSS}$; identical low side and high side switch with identical R_G ; $t_{cond}<2\mu\text{s}$

3 Electrical characteristics

at $T_j = 25^\circ\text{C}$, unless otherwise specified

Table 4 Static characteristics

Parameter	Symbol	Values			Unit	Note / Test Condition
		Min.	Typ.	Max.		
Drain-source breakdown voltage	$V_{(BR)DSS}$	800	-	-	V	$V_{GS}=0V, I_D=1mA$
Gate threshold voltage	$V_{GS(th)}$	2.5	3	3.5	V	$V_{DS}=V_{GS}, I_D=0.14mA$
Zero gate voltage drain current	I_{DSS}	-	-	1	μA	$V_{DS}=800V, V_{GS}=0V, T_j=25^\circ C$ $V_{DS}=800V, V_{GS}=0V, T_j=150^\circ C$
Gate-source leakage current incl. zener diode	I_{GSS}	-	-	1	μA	$V_{GS}=20V, V_{DS}=0V$
Drain-source on-state resistance	$R_{DS(on)}$	-	0.64	0.75	Ω	$V_{GS}=10V, I_D=2.7A, T_j=25^\circ C$ $V_{GS}=10V, I_D=2.7A, T_j=150^\circ C$
Gate resistance	R_G	-	1	-	Ω	$f=250kHz, \text{open drain}$

Table 5 Dynamic characteristics

Parameter	Symbol	Values			Unit	Note / Test Condition
		Min.	Typ.	Max.		
Input capacitance	C_{iss}	-	460	-	pF	$V_{GS}=0V, V_{DS}=500V, f=250kHz$
Output capacitance	C_{oss}	-	9	-	pF	$V_{GS}=0V, V_{DS}=500V, f=250kHz$
Effective output capacitance, energy related ¹⁾	$C_{o(er)}$	-	13	-	pF	$V_{GS}=0V, V_{DS}=0 \text{ to } 500V$
Effective output capacitance, time related ²⁾	$C_{o(tr)}$	-	164	-	pF	$I_D=\text{constant}, V_{GS}=0V, V_{DS}=0 \text{ to } 500V$
Turn-on delay time	$t_{d(on)}$	-	8	-	ns	$V_{DD}=400V, V_{GS}=13V, I_D=2.7A, R_G=12\Omega$
Rise time	t_r	-	8	-	ns	$V_{DD}=400V, V_{GS}=13V, I_D=2.7A, R_G=12\Omega$
Turn-off delay time	$t_{d(off)}$	-	40	-	ns	$V_{DD}=400V, V_{GS}=13V, I_D=2.7A, R_G=12\Omega$
Fall time	t_f	-	20	-	ns	$V_{DD}=400V, V_{GS}=13V, I_D=2.7A, R_G=12\Omega$

Table 6 Gate charge characteristics

Parameter	Symbol	Values			Unit	Note / Test Condition
		Min.	Typ.	Max.		
Gate to source charge	Q_{gs}	-	2	-	nC	$V_{DD}=640V, I_D=2.7A, V_{GS}=0 \text{ to } 10V$
Gate to drain charge	Q_{gd}	-	7	-	nC	$V_{DD}=640V, I_D=2.7A, V_{GS}=0 \text{ to } 10V$
Gate charge total	Q_g	-	17	-	nC	$V_{DD}=640V, I_D=2.7A, V_{GS}=0 \text{ to } 10V$
Gate plateau voltage	$V_{plateau}$	-	4.5	-	V	$V_{DD}=640V, I_D=2.7A, V_{GS}=0 \text{ to } 10V$

¹⁾ $C_{o(er)}$ is a fixed capacitance that gives the same stored energy as C_{oss} while V_{DS} is rising from 0 to 500V

²⁾ $C_{o(tr)}$ is a fixed capacitance that gives the same charging time as C_{oss} while V_{DS} is rising from 0 to 500V

Table 7 Reverse diode characteristics

Parameter	Symbol	Values			Unit	Note / Test Condition
		Min.	Typ.	Max.		
Diode forward voltage	V_{SD}	-	0.9	-	V	$V_{GS}=0V, I_F=2.7A, T_i=25^{\circ}C$
Reverse recovery time	t_{rr}	-	630	-	ns	$V_R=400V, I_F=1.4A, di_F/dt=50A/\mu s$
Reverse recovery charge	Q_{rr}	-	5.2	-	μC	$V_R=400V, I_F=1.4A, di_F/dt=50A/\mu s$
Peak reverse recovery current	I_{rrm}	-	13	-	A	$V_R=400V, I_F=1.4A, di_F/dt=50A/\mu s$

4 Electrical characteristics diagrams

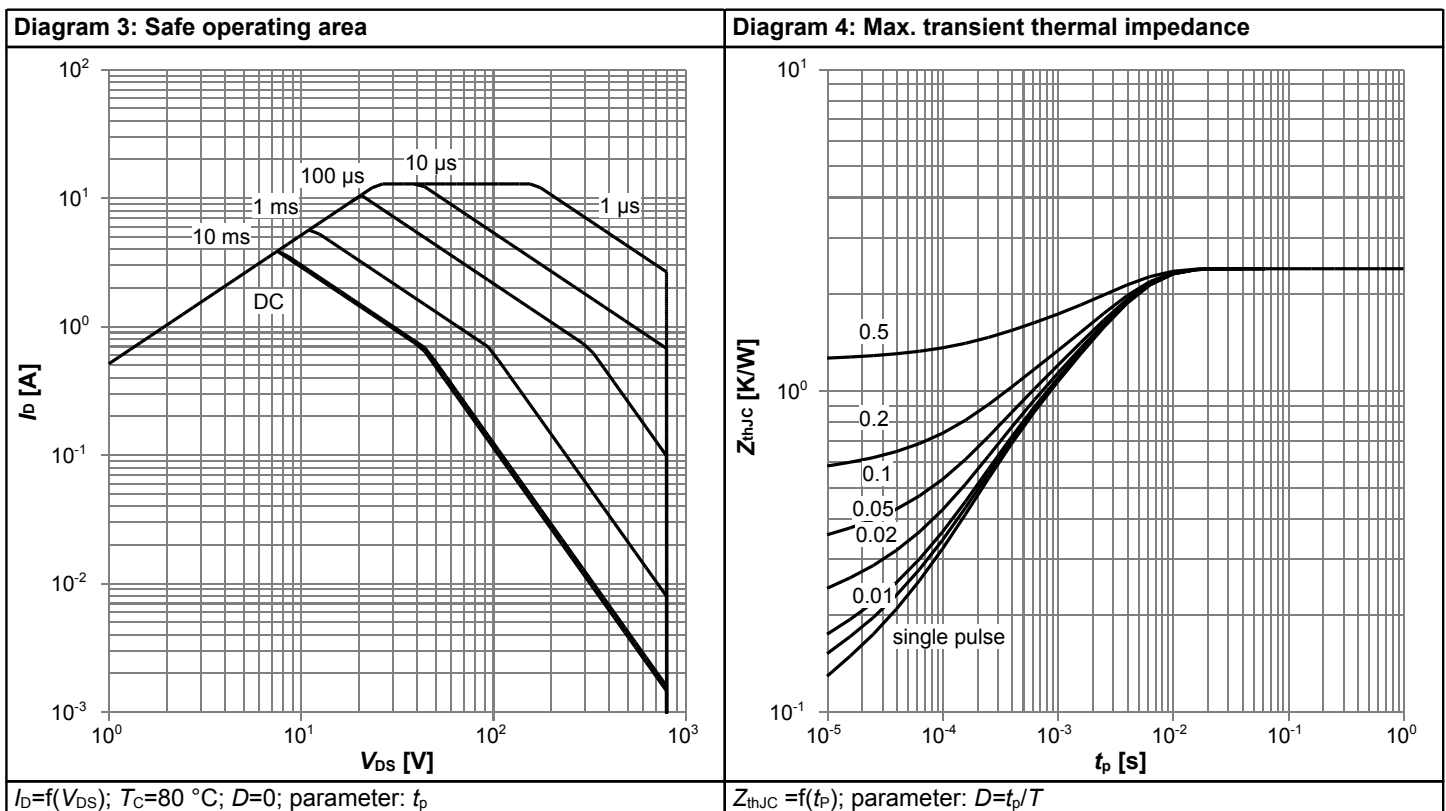
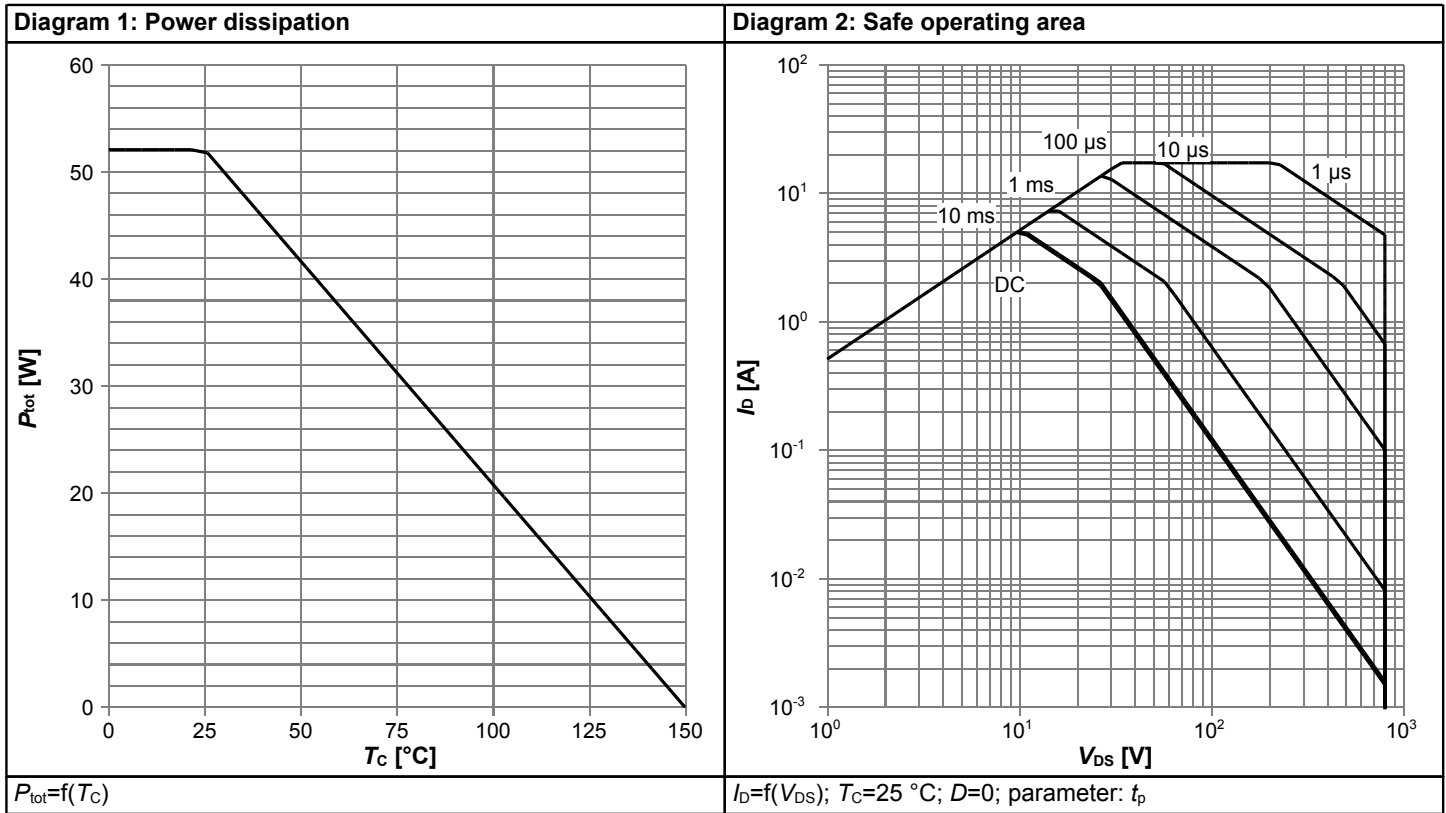
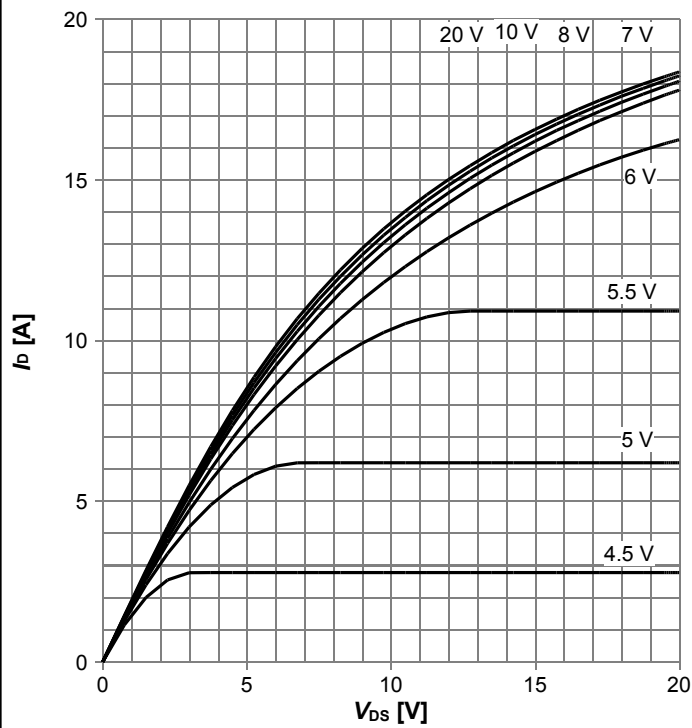
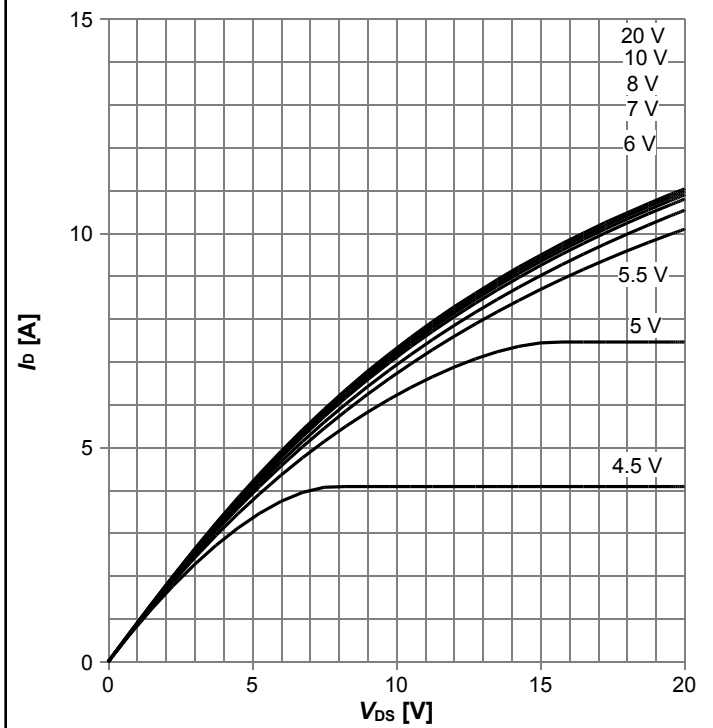

Diagram 5: Typ. output characteristics



$I_D = f(V_{DS})$; $T_j = 25^\circ\text{C}$; parameter: V_{GS}

Diagram 6: Typ. output characteristics



$I_D = f(V_{DS})$; $T_j = 125^\circ\text{C}$; parameter: V_{GS}

Diagram 7: Typ. drain-source on-state resistance

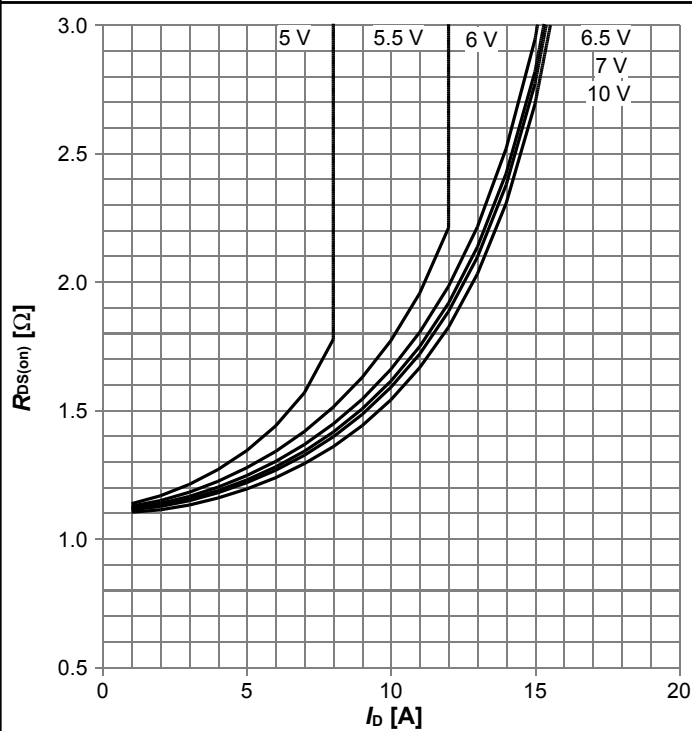

$R_{DS(on)} = f(I_D)$; $T_j = 125^\circ\text{C}$; parameter: V_{GS}

Diagram 8: Drain-source on-state resistance

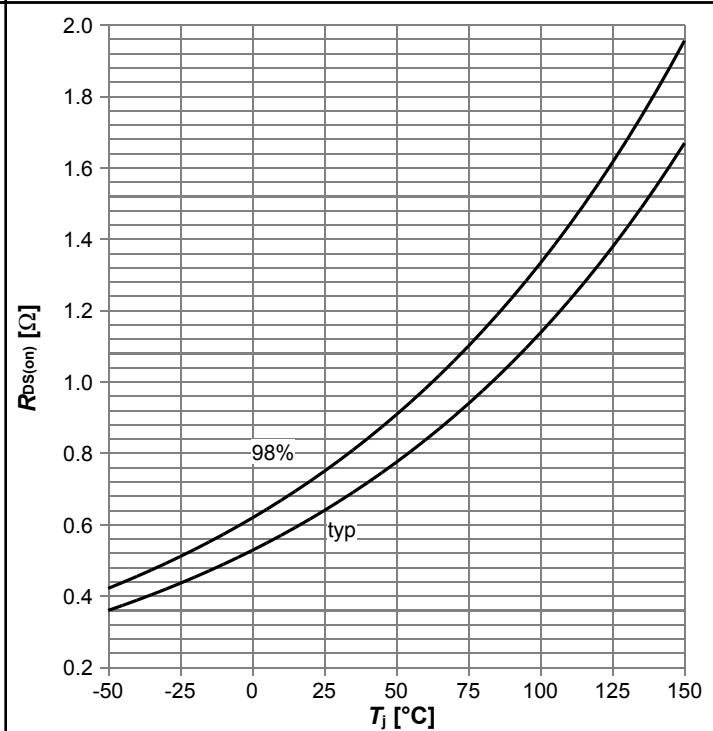

$R_{DS(on)} = f(T_j)$; $I_D = 2.7\text{ A}$; $V_{GS} = 10\text{ V}$

Diagram 9: Typ. transfer characteristics

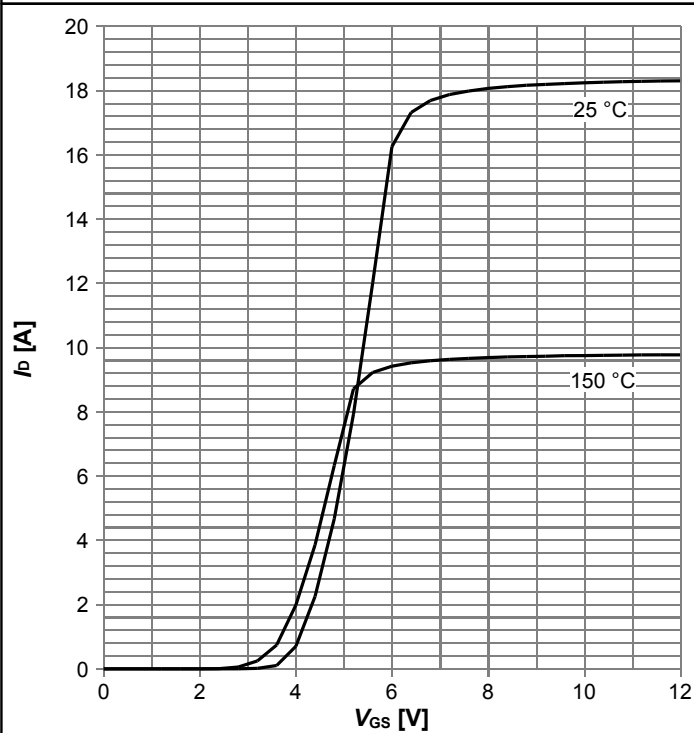

$I_D=f(V_{GS})$; $V_{DS}=20V$; parameter: T_j

Diagram 10: Typ. gate charge

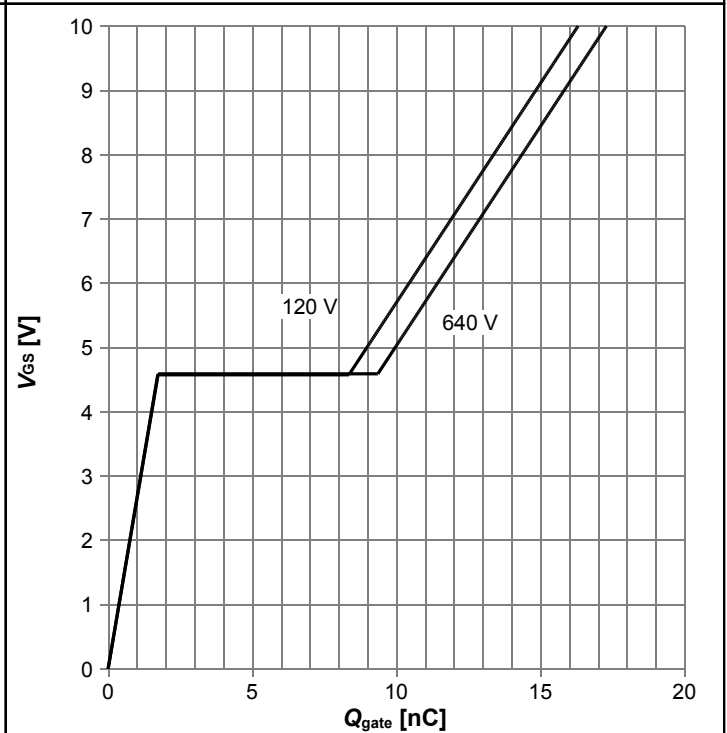

$V_{GS}=f(Q_{gate})$; $I_D=2.7 A$ pulsed; parameter: V_{DD}

Diagram 11: Forward characteristics of reverse diode

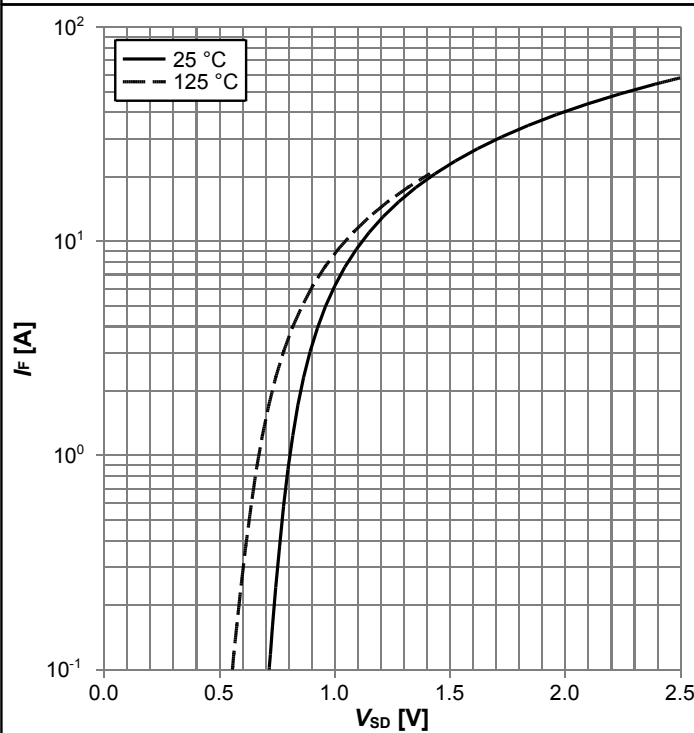

$I_F=f(V_{SD})$; parameter: T_j

Diagram 12: Avalanche energy

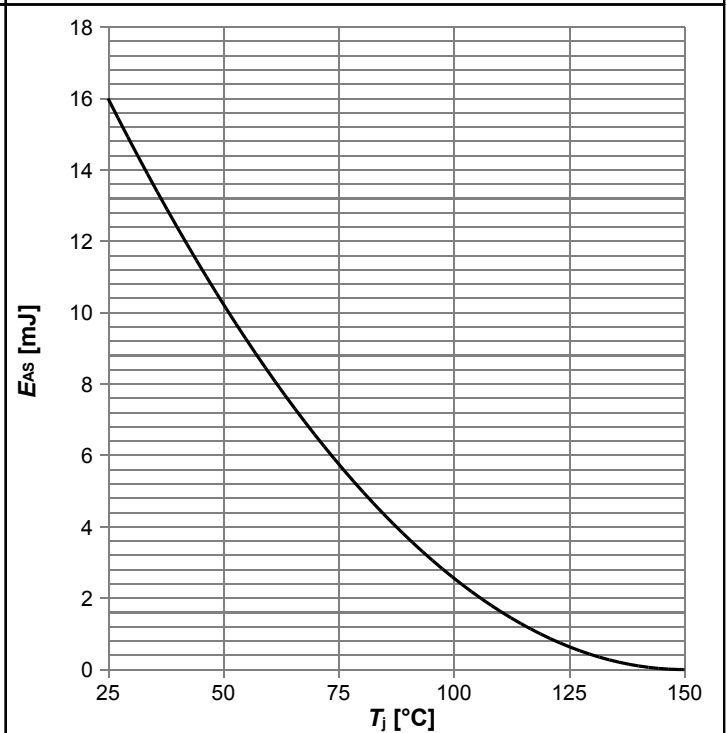

$E_{AS}=f(T_j)$; $I_D=1.1 A$; $V_{DD}=50 V$

Diagram 13: Drain-source breakdown voltage



$V_{BR(DSS)}=f(T_j); I_D=1 \text{ mA}$

Diagram 14: Typ. capacitances

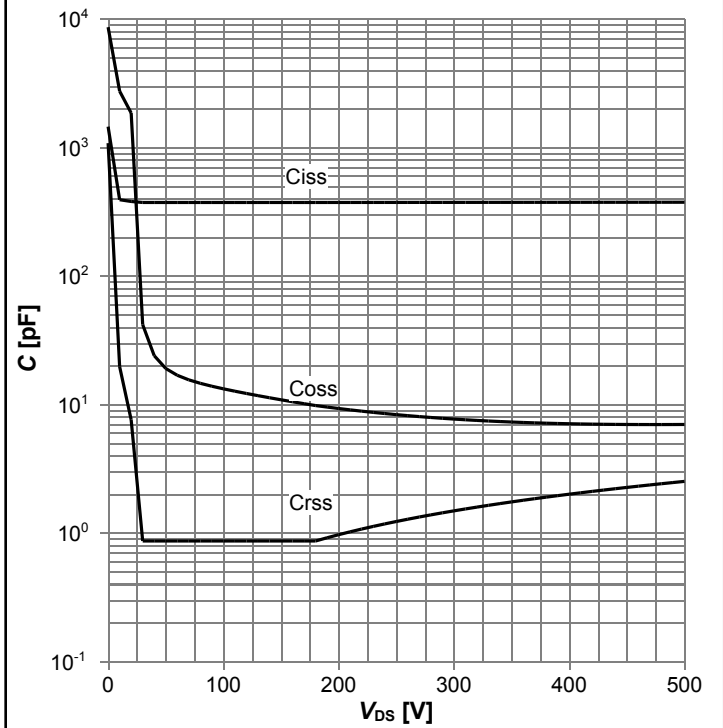

$C=f(V_{DS}); V_{GS}=0 \text{ V}; f=250 \text{ kHz}$

Diagram 15: Typ. Coss stored energy

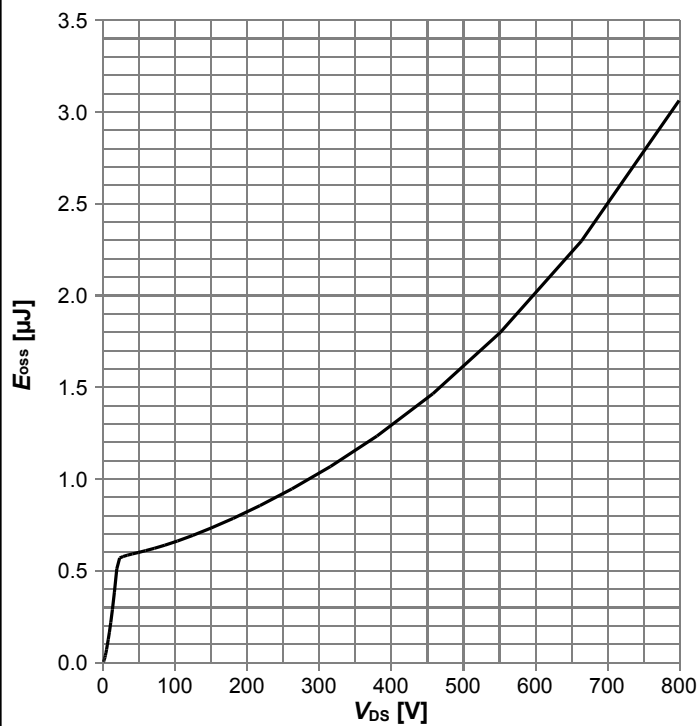

$E_{oss}=f(V_{DS})$

5 Test Circuits

Table 8 Diode characteristics



Table 9 Switching times

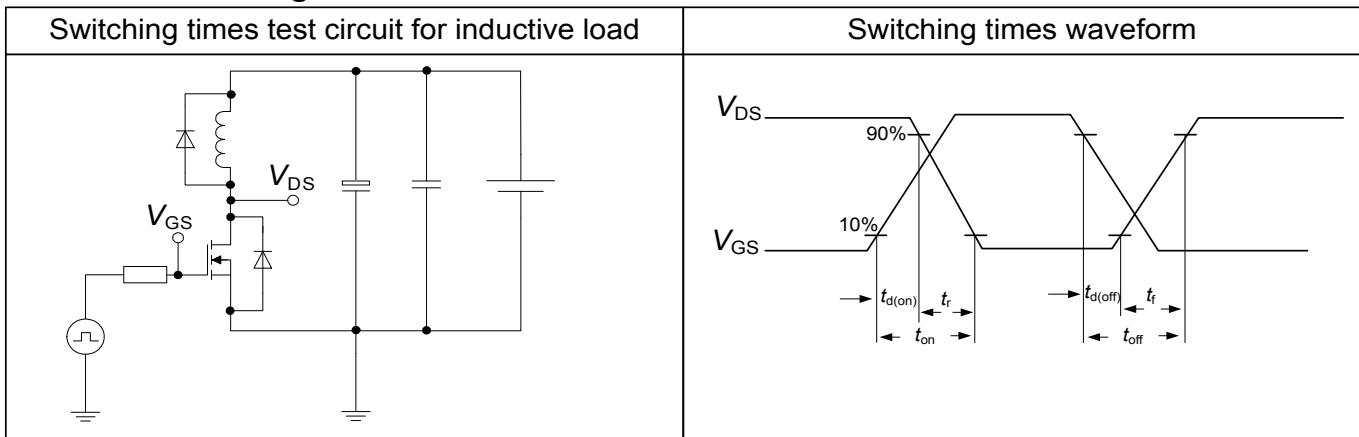
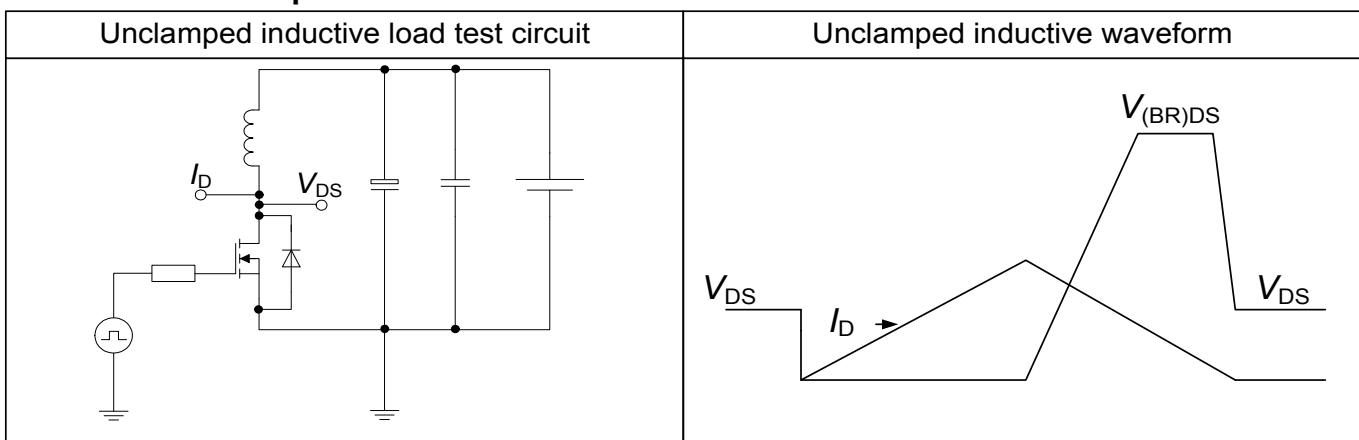
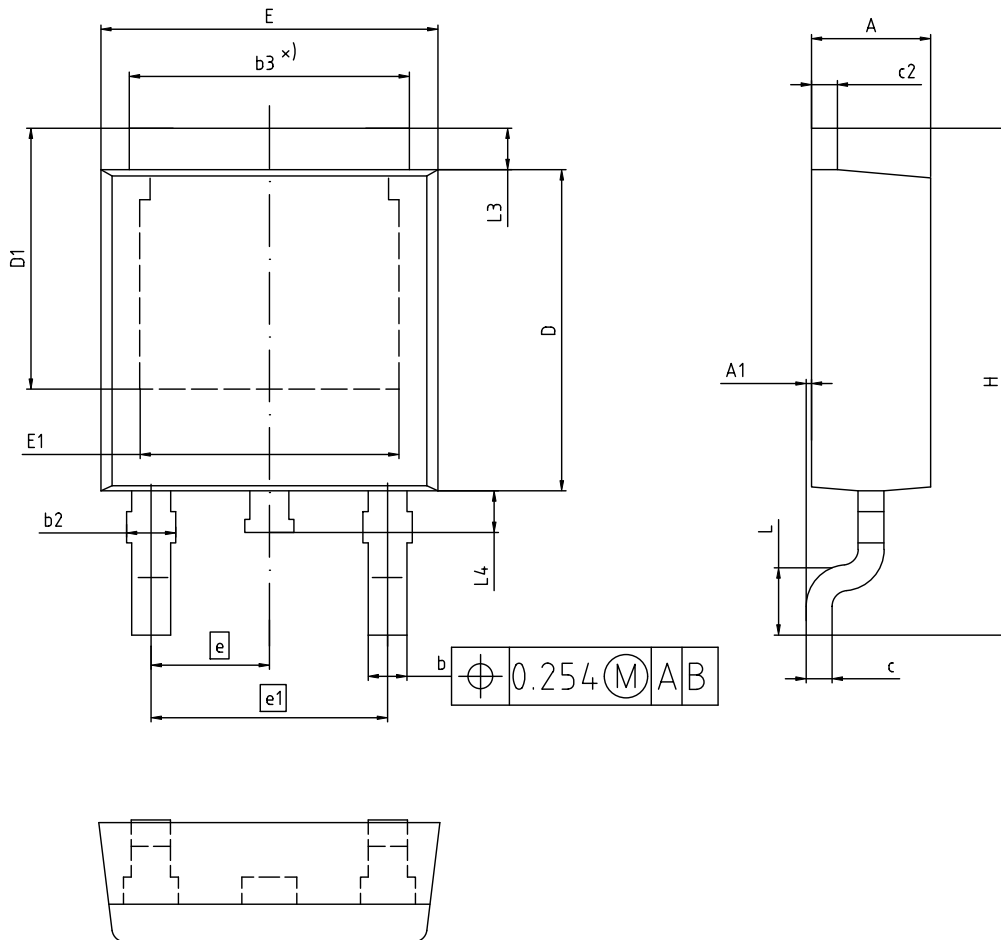

Table 10 Unclamped inductive load



6 Package Outlines

PG-TO252-3 (DPAK)



ALL DIMENSIONS REFER TO JEDEC STANDARD TO-252 AND DO NOT INCLUDE MOLD FLASH OR PROTRUSIONS.

DIMENSION	MILLIMETERS	
	MIN.	MAX.
A	2.16	2.41
A1	0.00	0.15
b	0.64	0.89
b2	0.65	1.15
b3	4.95	5.50
c	0.46	0.61
c2	0.40	0.98
D	5.97	6.22
D1	5.02	5.84
E	6.35	6.73
E1	4.32	5.50
e	2.29	
e1	4.57	
N	3	
H	9.40	10.48
L	1.18	1.78
L3	0.89	1.27
L4	0.51	1.02

DOCUMENT NO. Z8B00003328
REVISION 07
SCALE: 10:1 0 1 2mm
EUROPEAN PROJECTION
ISSUE DATE 01.04.2020

Figure 1 Outline PG-TO252-3, dimensions in mm/inches

7 Appendix A

Table 11 Related Links

- IFX CoolMOS Webpage: www.infineon.com
- IFX Design tools: www.infineon.com

Revision History

IPD80R750P7

Revision: 2020-05-26, Rev. 2.2

Previous Revision

Revision	Date	Subjects (major changes since last revision)
2.0	2017-06-07	Release of final version
2.1	2018-02-09	Corrected front page text
2.2	2020-05-26	Updated package/symbol drawing, and product validation

Trademarks

All referenced product or service names and trademarks are the property of their respective owners.

We Listen to Your Comments

Any information within this document that you feel is wrong, unclear or missing at all? Your feedback will help us to continuously improve the quality of this document. Please send your proposal (including a reference to this document) to:

erratum@infineon.com

Published by

Infineon Technologies AG
81726 München, Germany
© 2020 Infineon Technologies AG
All Rights Reserved.

Legal Disclaimer

The information given in this document shall in no event be regarded as a guarantee of conditions or characteristics ("Beschaffheitsgarantie").

With respect to any examples, hints or any typical values stated herein and/or any information regarding the application of the product, Infineon Technologies hereby disclaims any and all warranties and liabilities of any kind, including without limitation warranties of non-infringement of intellectual property rights of any third party.

In addition, any information given in this document is subject to customer's compliance with its obligations stated in this document and any applicable legal requirements, norms and standards concerning customer's products and any use of the product of Infineon Technologies in customer's applications.

The data contained in this document is exclusively intended for technically trained staff. It is the responsibility of customer's technical departments to evaluate the suitability of the product for the intended application and the completeness of the product information given in this document with respect to such application.

Information

For further information on technology, delivery terms and conditions and prices please contact your nearest Infineon Technologies Office (www.infineon.com).

Warnings

Due to technical requirements, components may contain dangerous substances. For information on the types in question, please contact the nearest Infineon Technologies Office.

The Infineon Technologies component described in this Data Sheet may be used in life-support devices or systems and/or automotive, aviation and aerospace applications or systems only with the express written approval of Infineon Technologies, if a failure of such components can reasonably be expected to cause the failure of that life-support, automotive, aviation and aerospace device or system or to affect the safety or effectiveness of that device or system. Life support devices or systems are intended to be implanted in the human body or to support and/or maintain and sustain and/or protect human life. If they fail, it is reasonable to assume that the health of the user or other persons may be endangered.

X-ON Electronics

Largest Supplier of Electrical and Electronic Components

Click to view similar products for [MOSFET](#) category:

Click to view products by [Infineon](#) manufacturer:

Other Similar products are found below :

[614233C](#) [648584F](#) [IRFD120](#) [JANTX2N5237](#) [FCA20N60_F109](#) [FDZ595PZ](#) [2SK2545\(Q,T\)](#) [405094E](#) [423220D](#) [TPCC8103,L1Q\(CM](#)
[MIC4420CM-TR](#) [VN1206L](#) [614234A](#) [715780A](#) [NTNS3166NZT5G](#) [SSM6J414TU,LF\(T](#) [751625C](#) [BUK954R8-60E](#) [NTE6400](#) [SQJ402EP-](#)
[T1-GE3](#) [2SK2614\(TE16L1,Q\)](#) [2N7002KW-FAI](#) [DMN1017UCP3-7](#) [EFC2J004NUZTDG](#) [ECH8691-TL-W](#) [FCAB21350L1](#) [P85W28HP2F-](#)
[7071](#) [DMN1053UCP4-7](#) [NTE221](#) [NTE222](#) [NTE2384](#) [NTE2903](#) [NTE2941](#) [NTE2945](#) [NTE2946](#) [NTE2960](#) [NTE2967](#) [NTE2969](#) [NTE2976](#)
[NTE6400A](#) [NTE2910](#) [NTE2916](#) [NTE2956](#) [NTE2911](#) [DMN2080UCB4-7](#) [TK10A80W,S4X\(S](#) [SSM6P69NU,LF](#) [DMP22D4UFO-7B](#)
[DMN1006UCA6-7](#) [DMN16M9UCA6-7](#)