

MOSFET

600V CoolMOS™ CM8 Power Transistor

The CoolMOS™ 8th generation platform is a revolutionary technology for high voltage power MOSFETs, designed according to the superjunction (SJ) principle and pioneered by Infineon Technologies. The 600V CoolMOS™ CM8 series is the successor to the CoolMOS™ 7. It combines the benefits of a fast switching SJ MOSFET with excellent ease of use, e.g. low ringing tendency, implemented fast body diode (CFD) for all products with outstanding robustness against hard commutation and excellent ESD capability. Furthermore, extremely low switching and conduction losses of CM8, make switching applications even more efficient.

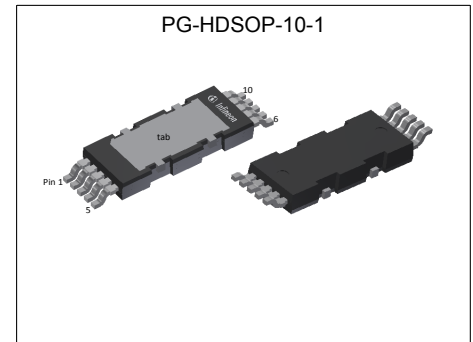

Features

- Suitable for hard and soft switching topologies thanks to an outstanding commutation ruggedness
- Significant reduction of switching and conduction losses
- Best in class $R_{DS(on)}$ per package products enabled by ultra low $R_{DS(on)} \cdot A$

Benefits

- Ease of use and fast design-in through low ringing tendency and usage across PFC and PWM stages
- Simplified thermal management thanks to our advanced die attach technique
- Increased power density solutions enabled by using products with smaller footprint and higher manufacturing quality due state of the art ESD protection
- Suitable for a wide variety of applications and power ranges

Potential applications

- Power supplies and converters
- PFC stages & LLC resonant converters
- High efficiency switching applications
- e.g. Server, Telecom, EV Charging, UPS

Product validation

Fully qualified according to JEDEC for Industrial Applications

Please note: For MOSFET paralleling the use of ferrite beads on the gate or separate totem poles is generally recommended.

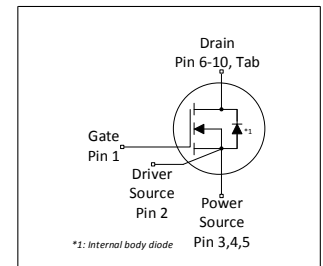

RoHS

Table 1 Key Performance Parameters

Parameter	Value	Unit
$V_{DS} @ T_{j,max}$	650	V
$R_{DS(on),max}$	37	mΩ
$Q_{g,typ}$	79	nC
$I_{D,pulse}$	230	A
$E_{oss} @ 400V$	10.6	μJ
Body diode di_F/dt	1300	A/μs
ESD class (HBM)	2	-

Type / Ordering Code	Package	Marking	Related Links
IPDD60R037CM8	PG-HDSOP-10	60R037C8	see Appendix A

Table of Contents

Description	1
Maximum ratings	3
Thermal characteristics	4
Electrical characteristics	5
Electrical characteristics diagrams	7
Test Circuits	11
Package Outlines	12
Appendix A	13
Revision History	14
Trademarks	14
Disclaimer	14

1 Maximum ratings

at $T_j = 25^\circ\text{C}$, unless otherwise specified

Table 2 Maximum ratings

Parameter	Symbol	Values			Unit	Note / Test Condition
		Min.	Typ.	Max.		
Continuous drain current ¹⁾	I_D	-	-	72 45	A	$T_C=25^\circ\text{C}$ $T_C=100^\circ\text{C}$
Pulsed drain current ²⁾	$I_{D,pulse}$	-	-	230	A	$T_C=25^\circ\text{C}$
Avalanche energy, single pulse	E_{AS}	-	-	135	mJ	$I_D=7.8\text{A}$; $V_{DD}=50\text{V}$; see table 10
Avalanche energy, repetitive	E_{AR}	-	-	0.68	mJ	$I_D=7.8\text{A}$; $V_{DD}=50\text{V}$; see table 10
Avalanche current, single pulse	I_{AS}	-	-	7.8	A	-
MOSFET dv/dt ruggedness	dv/dt	-	-	120	V/ns	$V_{DS}=0\dots400\text{V}$
Gate source voltage (static)	V_{GS}	-20	-	20	V	static;
Gate source voltage (dynamic)	V_{GS}	-30	-	30	V	AC ($f>1\text{ Hz}$)
Power dissipation	P_{tot}	-	-	416	W	$T_C=25^\circ\text{C}$
Storage temperature	T_{stg}	-55	-	150	$^\circ\text{C}$	-
Operating junction temperature	T_j	-55	-	150	$^\circ\text{C}$	-
Extended operating junction temperature	T_j	150	-	175	$^\circ\text{C}$	$\leq 50\text{ h}$ in the application lifetime
Mounting torque	-	-	-	-	Ncm	-
Continuous diode forward current	I_S	-	-	72	A	$T_C=25^\circ\text{C}$
Diode pulse current ²⁾	$I_{S,pulse}$	-	-	230	A	$T_C=25^\circ\text{C}$
Reverse diode dv/dt ³⁾	dv/dt	-	-	70	V/ns	$V_{DS}=0\dots400\text{V}$, $I_{SD}\leq 72\text{A}$, $T_j=25^\circ\text{C}$ see table 8
Maximum diode commutation speed	di _F /dt	-	-	1300	A/ μs	$V_{DS}=0\dots400\text{V}$, $I_{SD}\leq 72\text{A}$, $T_j=25^\circ\text{C}$ see table 8
Insulation withstand voltage	V_{ISO}	-	-	n.a.	V	V_{rms} , $T_C=25^\circ\text{C}$, $t=1\text{min}$

¹⁾ Limited by $T_{j,max}$.

²⁾ Pulse width t_p limited by $T_{j,max}$

³⁾ Identical low side and high side switch with identical R_θ

2 Thermal characteristics

Table 3 Thermal characteristics

Parameter	Symbol	Values			Unit	Note / Test Condition
		Min.	Typ.	Max.		
Thermal resistance, junction - case	R_{thJC}	-	-	0.3	K/W	-
Thermal resistance, junction - ambient	R_{thJA}	-	-	62	K/W	device on PCB, minimal footprint
Thermal resistance, junction - ambient for SMD version	R_{thJA}	-	55	60	K/W	Device on 40mm*40mm*1.5mm epoxy PCB FR4 with 6cm ² (one layer, 70μm thickness) copper area. Tap exposed to air. PCB is vertical without air stream cooling.
Soldering temperature, reflow soldering allowed	T_{sold}	-	-	260	°C	reflow MSL1

3 Electrical characteristics
 at $T_j=25^\circ\text{C}$, unless otherwise specified

Table 4 Static characteristics

Parameter	Symbol	Values			Unit	Note / Test Condition
		Min.	Typ.	Max.		
Drain-source breakdown voltage	$V_{(BR)DSS}$	600	-	-	V	$V_{GS}=0V, I_D=1mA$
Gate threshold voltage	$V_{(GS)th}$	3.7	4.2	4.7	V	$V_{DS}=V_{GS}, I_D=0.68mA$
Zero gate voltage drain current	I_{DSS}	-	-	1	μA	$V_{DS}=600V, V_{GS}=0V, T_j=25^\circ C$ $V_{DS}=600V, V_{GS}=0V, T_j=150^\circ C$
Gate-source leakage current	I_{GSS}	-	-	0.1	μA	$V_{GS}=20V, V_{DS}=0V$
Drain-source on-state resistance	$R_{DS(on)}$	-	0.031 0.068	0.037 -	Ω	$V_{GS}=10V, I_D=27.0A, T_j=25^\circ C$ $V_{GS}=10V, I_D=27.0A, T_j=150^\circ C$
Gate resistance	R_G	-	1	-	Ω	$f=1MHz$

Table 5 Dynamic characteristics

Parameter	Symbol	Values			Unit	Note / Test Condition
		Min.	Typ.	Max.		
Input capacitance	C_{iss}	-	3458	-	pF	$V_{GS}=0V, V_{DS}=400V, f=250kHz$
Output capacitance	C_{oss}	-	43	-	pF	$V_{GS}=0V, V_{DS}=400V, f=250kHz$
Effective output capacitance, energy related ¹⁾	$C_{o(er)}$	-	133	-	pF	$V_{GS}=0V, V_{DS}=0...400V$
Effective output capacitance, time related ²⁾	$C_{o(tr)}$	-	1371	-	pF	$I_D=constant, V_{GS}=0V, V_{DS}=0...400V$
Turn-on delay time	$t_{d(on)}$	-	20.6	-	ns	$V_{DD}=400V, V_{GS}=13V, I_D=13.5A,$ $R_G=5.3\Omega$; see table 9
Rise time	t_r	-	7.6	-	ns	$V_{DD}=400V, V_{GS}=13V, I_D=13.5A,$ $R_G=5.3\Omega$; see table 9
Turn-off delay time	$t_{d(off)}$	-	101.6	-	ns	$V_{DD}=400V, V_{GS}=13V, I_D=13.5A,$ $R_G=5.3\Omega$; see table 9
Fall time	t_f	-	5.8	-	ns	$V_{DD}=400V, V_{GS}=13V, I_D=13.5A,$ $R_G=5.3\Omega$; see table 9

Table 6 Gate charge characteristics

Parameter	Symbol	Values			Unit	Note / Test Condition
		Min.	Typ.	Max.		
Gate to source charge	Q_{GS}	-	21	-	nC	$V_{DD}=400V, I_D=13.5A, V_{GS}=0$ to 10V
Gate to drain charge	Q_{Gd}	-	28	-	nC	$V_{DD}=400V, I_D=13.5A, V_{GS}=0$ to 10V
Gate charge total	Q_g	-	79	-	nC	$V_{DD}=400V, I_D=13.5A, V_{GS}=0$ to 10V
Gate plateau voltage	$V_{plateau}$	-	5.9	-	V	$V_{DD}=400V, I_D=13.5A, V_{GS}=0$ to 10V

¹⁾ $C_{o(er)}$ is a fixed capacitance that gives the same stored energy as C_{oss} while V_{DS} is rising from 0 to 400V

²⁾ $C_{o(tr)}$ is a fixed capacitance that gives the same charging time as C_{oss} while V_{DS} is rising from 0 to 400V

Table 7 Reverse diode characteristics

Parameter	Symbol	Values			Unit	Note / Test Condition
		Min.	Typ.	Max.		
Diode forward voltage	V_{SD}	-	0.9	-	V	$V_{GS}=0V, I_F=13.5A, T_j=25^{\circ}C$
Reverse recovery time	t_{rr}	-	120	150	ns	$V_R=400V, I_F=13.5A, di_F/dt=100A/\mu s$; see table 8
Reverse recovery charge	Q_{rr}	-	0.73	1.10	μC	$V_R=400V, I_F=13.5A, di_F/dt=100A/\mu s$; see table 8
Peak reverse recovery current	I_{rrm}	-	11.8	-	A	$V_R=400V, I_F=13.5A, di_F/dt=100A/\mu s$; see table 8

4 Electrical characteristics diagrams

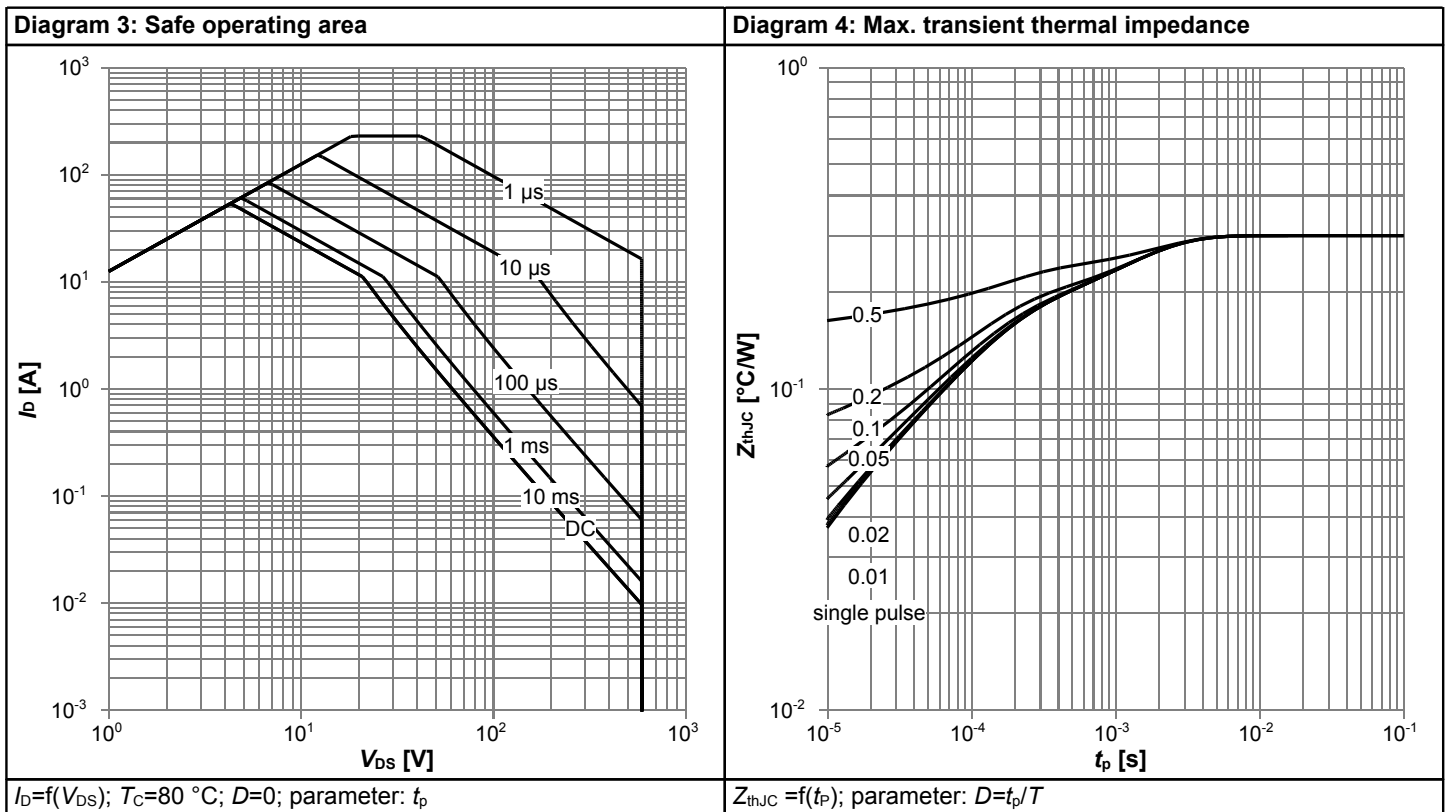
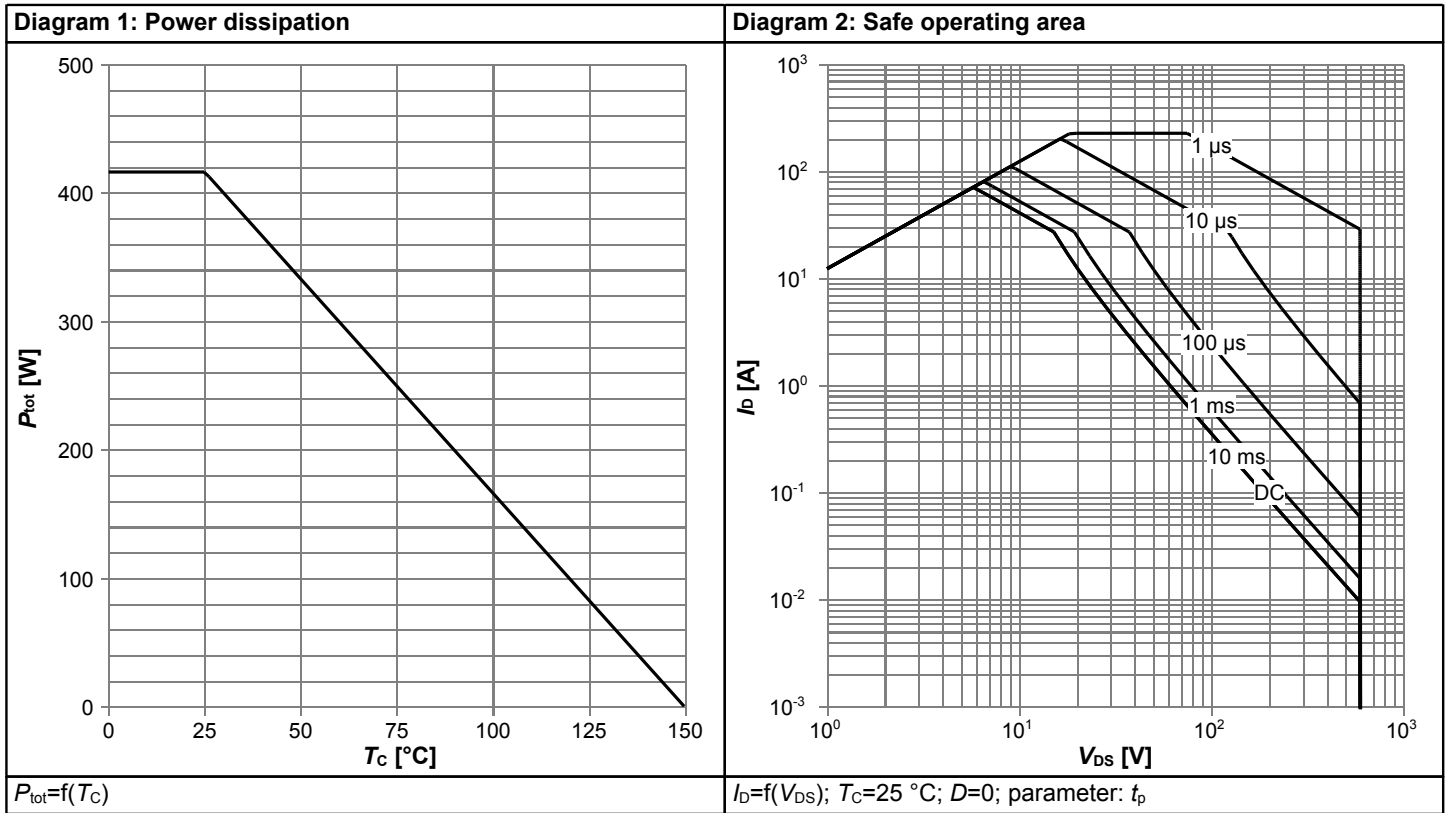
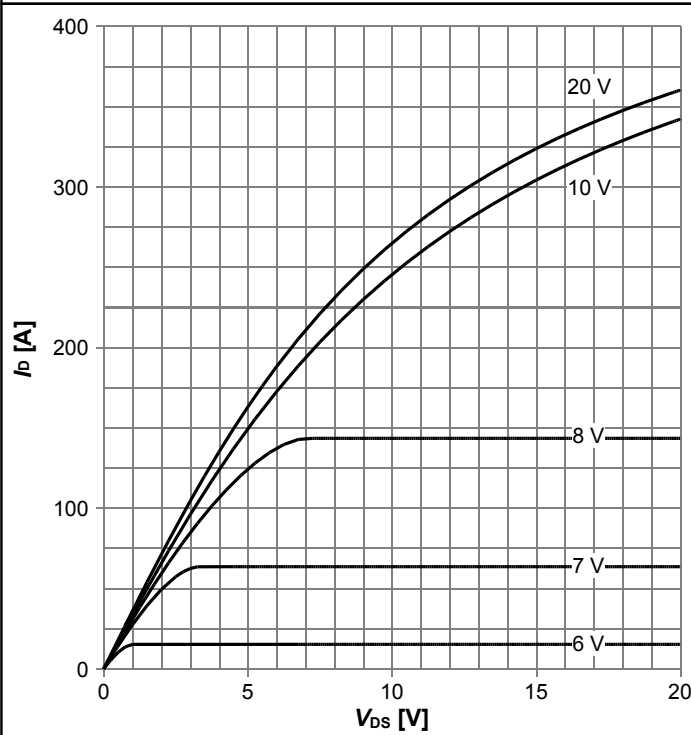
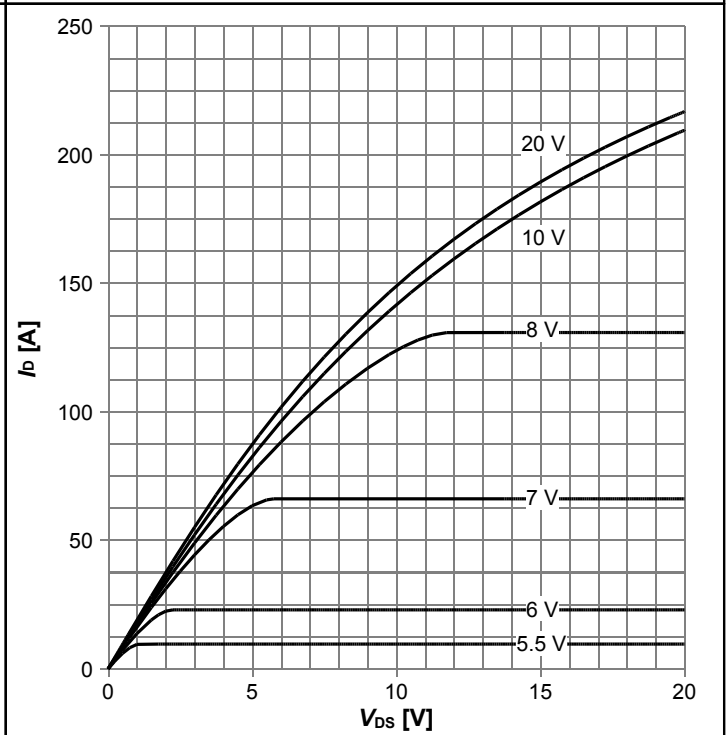

Diagram 5: Typ. output characteristics



$I_D=f(V_{DS})$; $T_j=25\text{ °C}$; parameter: V_{GS}

Diagram 6: Typ. output characteristics



$I_D=f(V_{DS})$; $T_j=125\text{ °C}$; parameter: V_{GS}

Diagram 7: Typ. drain-source on-state resistance

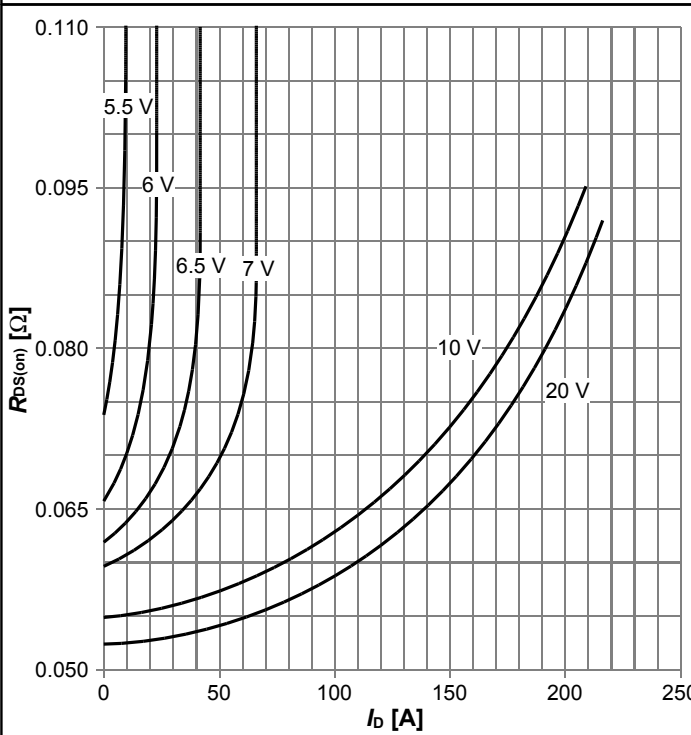

$R_{DS(on)}=f(I_D)$; $T_j=125\text{ °C}$; parameter: V_{GS}

Diagram 8: Drain-source on-state resistance

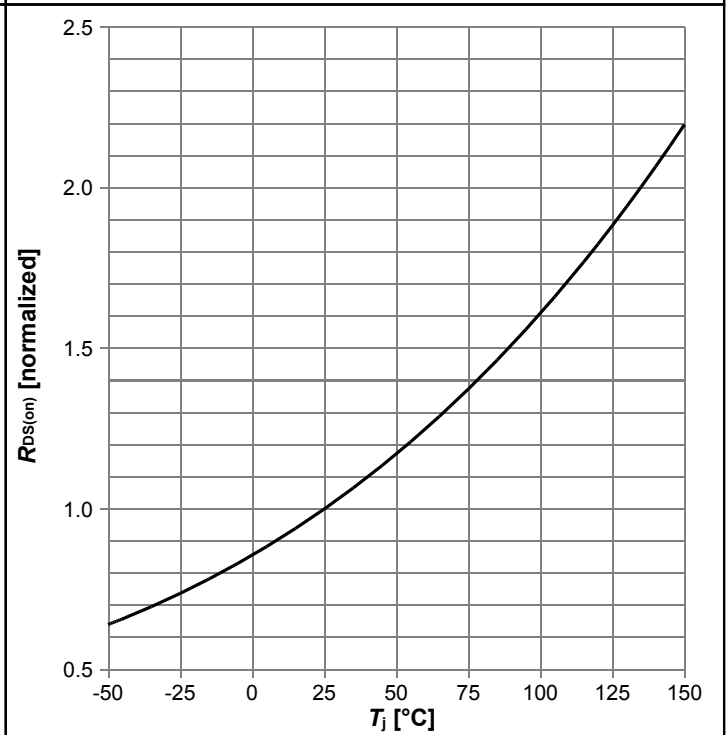

$R_{DS(on)}=f(T_j)$; $I_D=27.0\text{ A}$; $V_{GS}=10\text{ V}$

600V CoolMOS™ CM8 Power Transistor

IPDD60R037CM8

Diagram 9: Typ. transfer characteristics

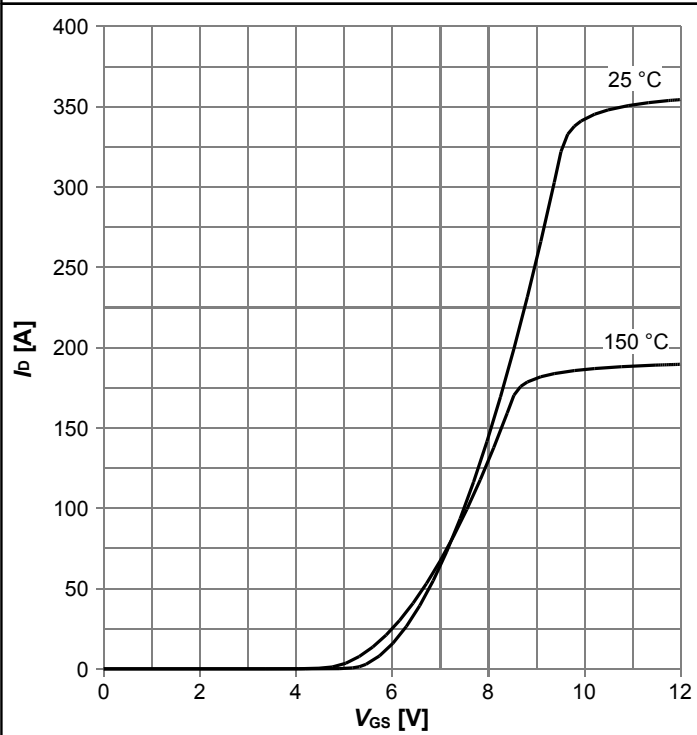

$I_D = f(V_{GS}); V_{DS} = 20V; \text{parameter: } T_j$

Diagram 10: Typ. gate charge

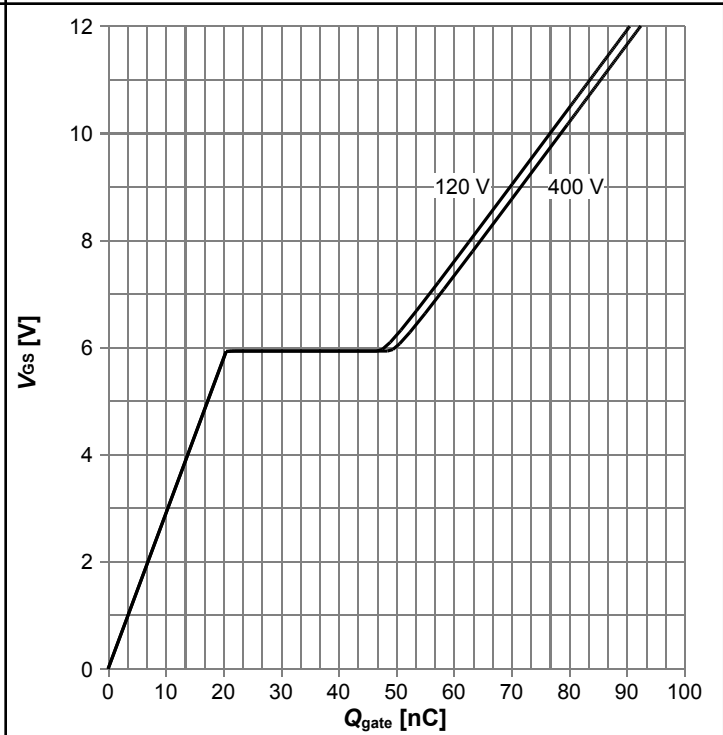

$V_{GS} = f(Q_{gate}); I_D = 13.5 \text{ A pulsed}; \text{parameter: } V_{DD}$

Diagram 11: Forward characteristics of reverse diode

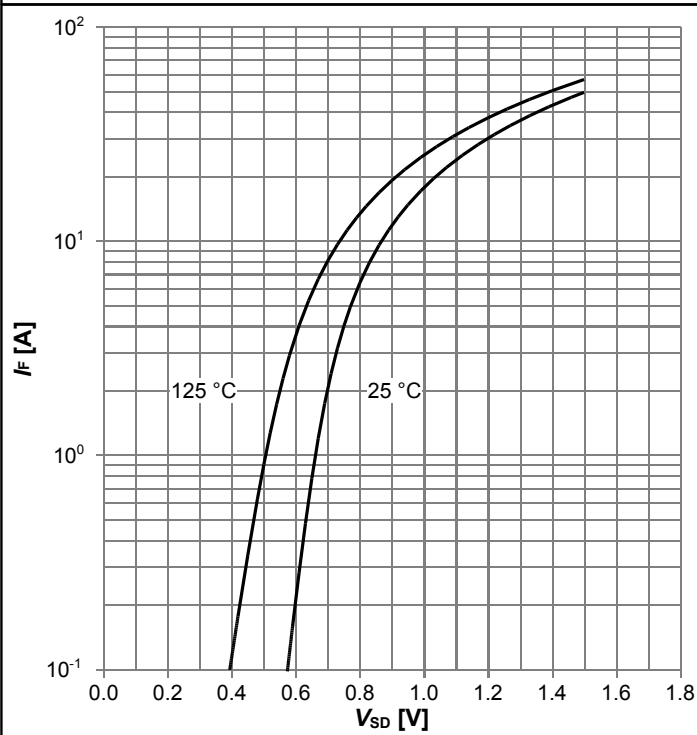

$I_F = f(V_{SD}); \text{parameter: } T_j$

Diagram 12: Avalanche energy

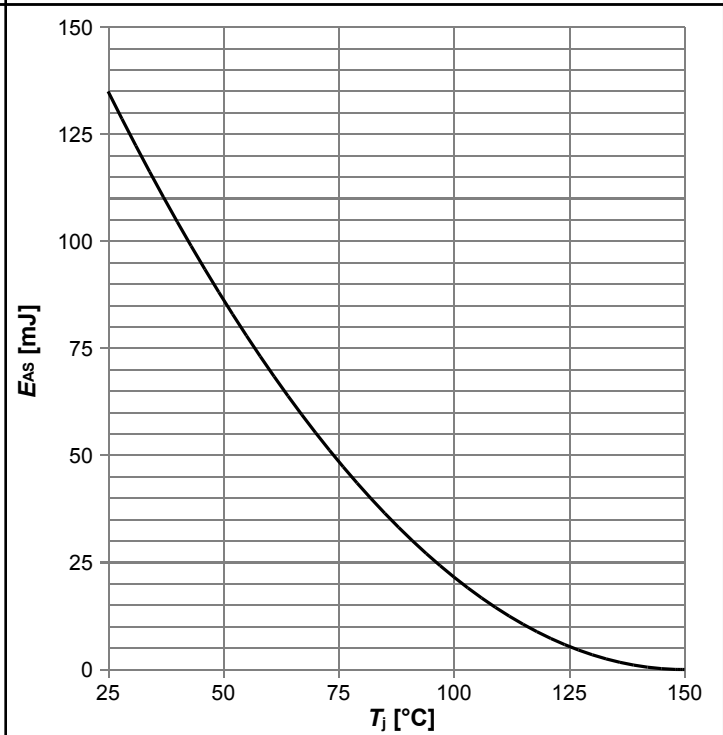

$E_{AS} = f(T_j); I_D = 7.8 \text{ A}; V_{DD} = 50 \text{ V}$

600V CoolMOS™ CM8 Power Transistor
IPDD60R037CM8

Diagram 13: Drain-source breakdown voltage

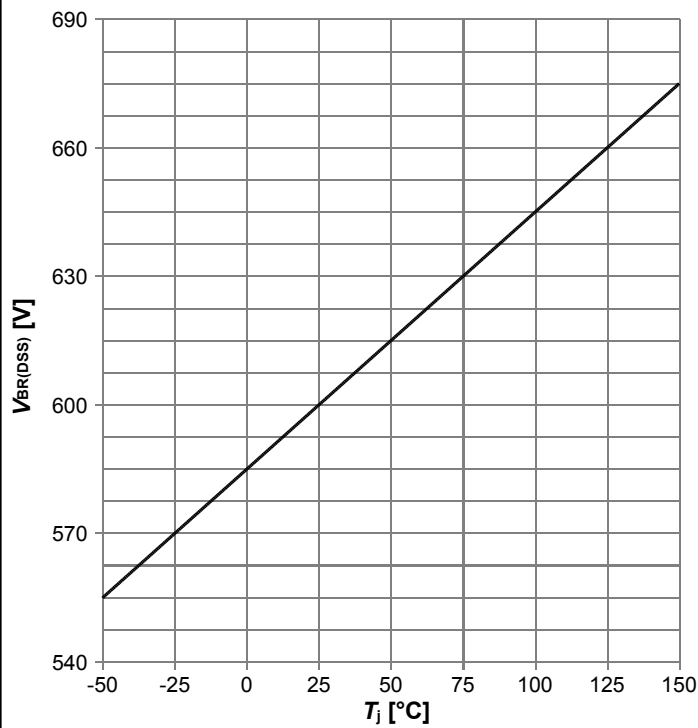

$V_{BR(DSS)}=f(T_j); I_D=1 \text{ mA}$

Diagram 14: Typ. capacitances

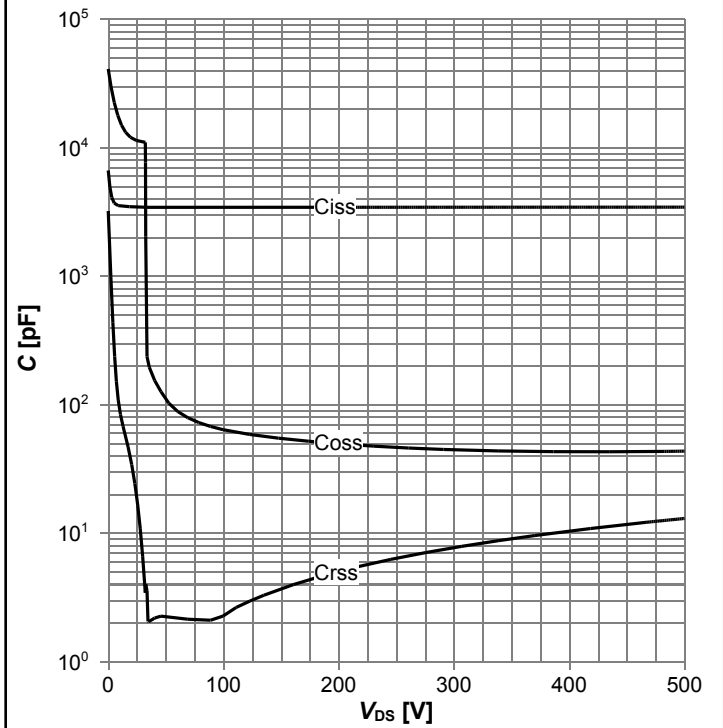

$C=f(V_{DS}); V_{GS}=0 \text{ V}; f=250 \text{ kHz}$

Diagram 15: Typ. Coss stored energy

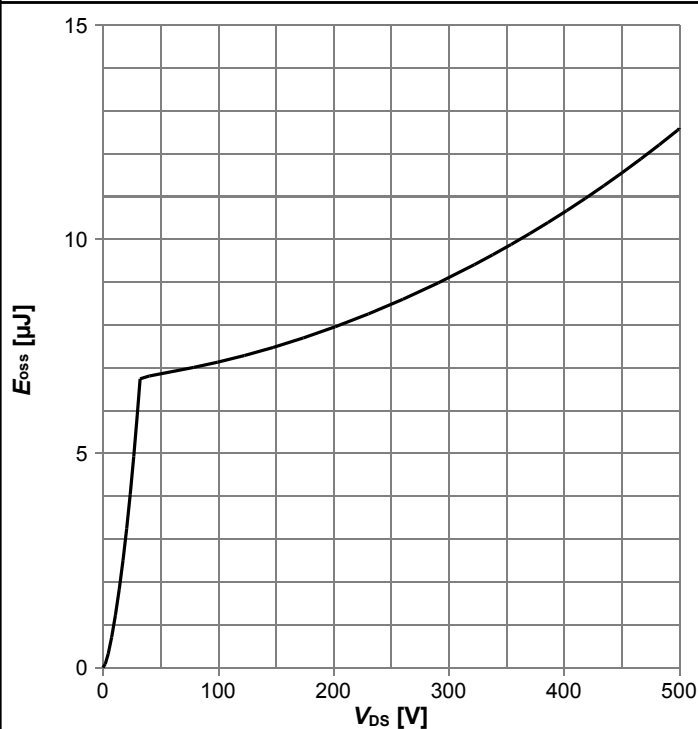

$E_{oss}=f(V_{DS})$

5 Test Circuits

Table 8 Diode characteristics



Table 9 Switching times (ss)

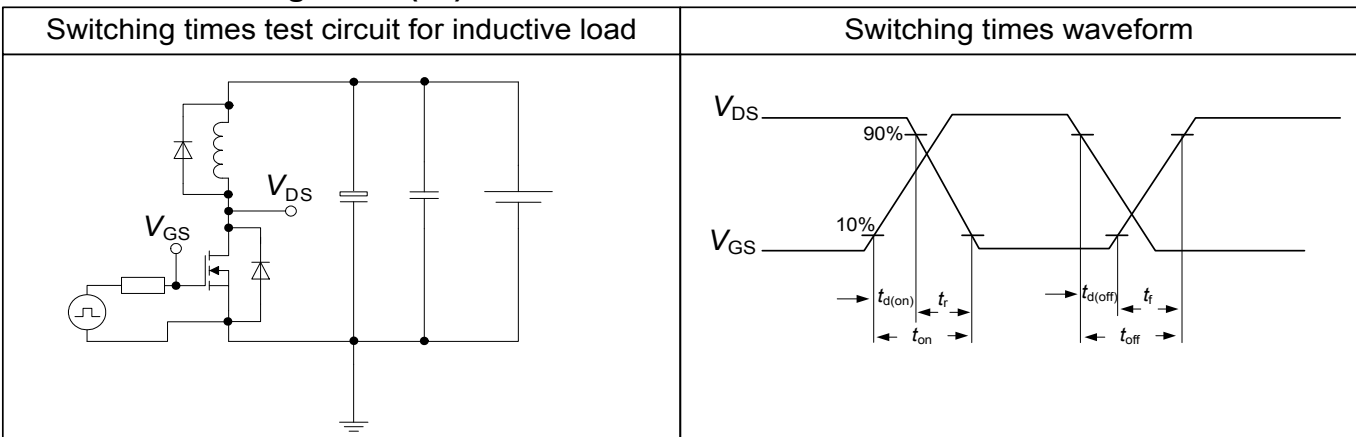
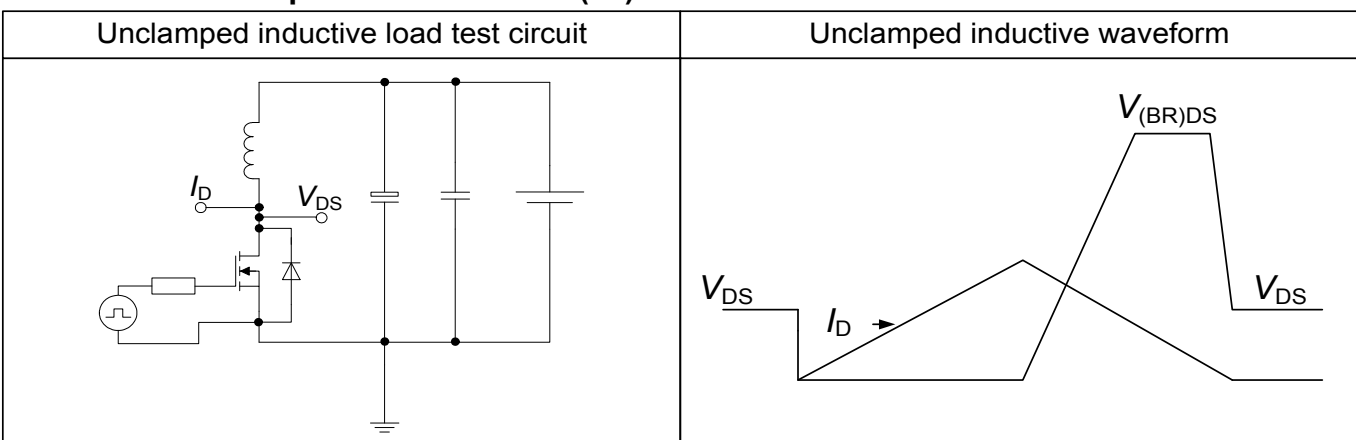
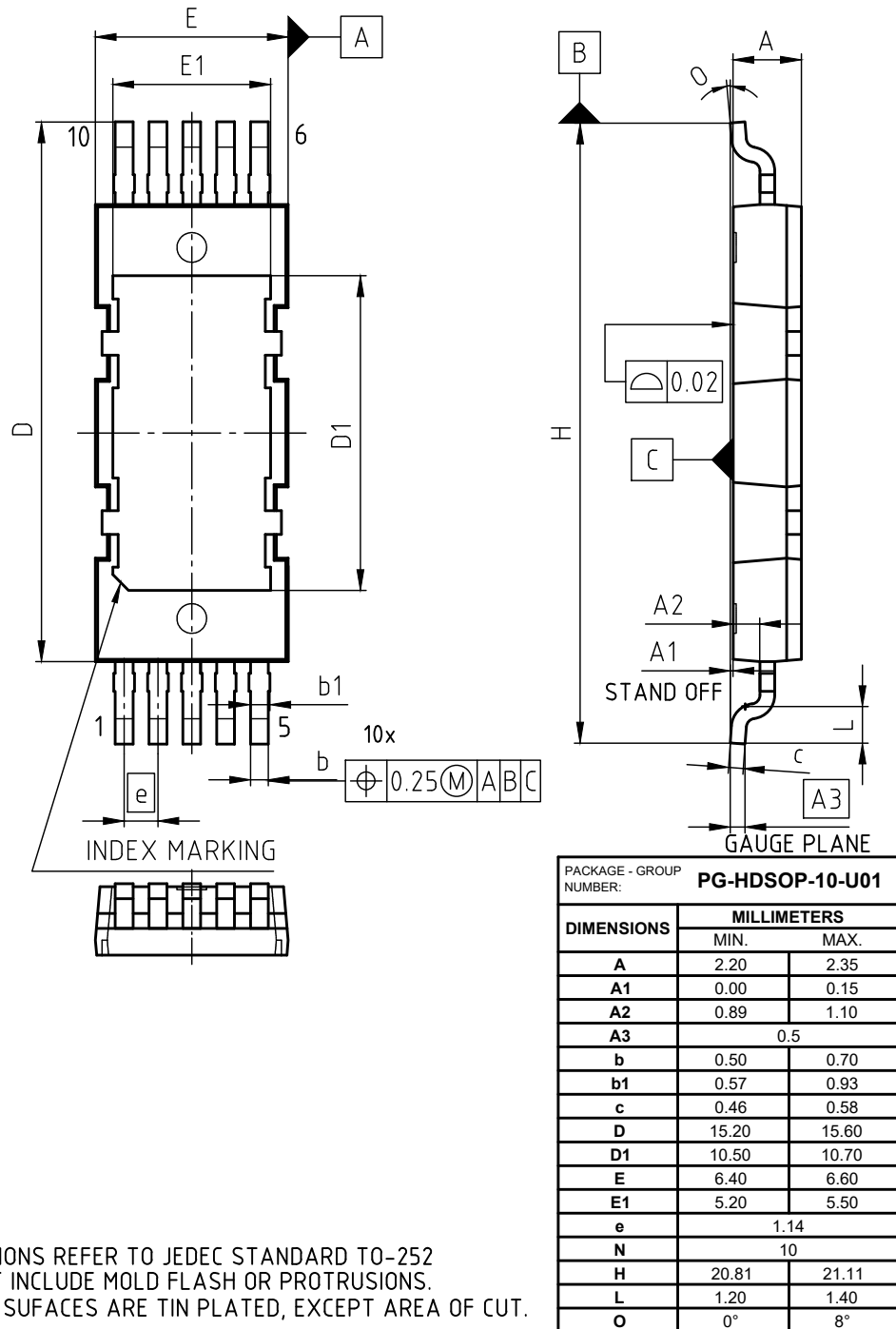

Table 10 Unclamped inductive load (ss)



6 Package Outlines



NOTES:

1. ALL DIMENSIONS REFER TO JEDEC STANDARD TO-252 AND DO NOT INCLUDE MOLD FLASH OR PROTRUSIONS.
2. ALL METAL SUFACES ARE TIN PLATED, EXCEPT AREA OF CUT.

Figure 1 Outline PG-HDSOP-10, dimensions in mm

7 Appendix A

Table 11 Related Links

- IFX CoolMOS CM8 Webpage: www.infineon.com
- IFX CoolMOS CM8 application note: www.infineon.com
- IFX CoolMOS CM8 simulation model: www.infineon.com
- IFX Design tools: www.infineon.com

Revision History

IPDD60R037CM8

Revision: 2024-03-21, Rev. 2.1

Previous Revision

Revision	Date	Subjects (major changes since last revision)
2.0	2023-10-25	Release of final version
2.1	2024-03-21	Update of R_{thJC}

Trademarks

All referenced product or service names and trademarks are the property of their respective owners.

We Listen to Your Comments

Any information within this document that you feel is wrong, unclear or missing at all? Your feedback will help us to continuously improve the quality of this document. Please send your proposal (including a reference to this document) to:

erratum@infineon.com

Published by

Infineon Technologies AG

81726 München, Germany

© 2023 Infineon Technologies AG

All Rights Reserved.

Legal Disclaimer

The information given in this document shall in no event be regarded as a guarantee of conditions or characteristics ("Beschaffenhheitsgarantie").

With respect to any examples, hints or any typical values stated herein and/or any information regarding the application of the product, Infineon Technologies hereby disclaims any and all warranties and liabilities of any kind, including without limitation warranties of non-infringement of intellectual property rights of any third party.

In addition, any information given in this document is subject to customer's compliance with its obligations stated in this document and any applicable legal requirements, norms and standards concerning customer's products and any use of the product of Infineon Technologies in customer's applications.

The data contained in this document is exclusively intended for technically trained staff. It is the responsibility of customer's technical departments to evaluate the suitability of the product for the intended application and the completeness of the product information given in this document with respect to such application.

Information

For further information on technology, delivery terms and conditions and prices please contact your nearest Infineon Technologies Office (www.infineon.com).

Warnings

Due to technical requirements, components may contain dangerous substances. For information on the types in question, please contact the nearest Infineon Technologies Office.

The Infineon Technologies component described in this Data Sheet may be used in life-support devices or systems and/or automotive, aviation and aerospace applications or systems only with the express written approval of Infineon Technologies, if a failure of such components can reasonably be expected to cause the failure of that life-support, automotive, aviation and aerospace device or system or to affect the safety or effectiveness of that device or system. Life support devices or systems are intended to be implanted in the human body or to support and/or maintain and sustain and/or protect human life. If they fail, it is reasonable to assume that the health of the user or other persons may be endangered.

X-ON Electronics

Largest Supplier of Electrical and Electronic Components

Click to view similar products for [Infineon manufacturer](#):

Other Similar products are found below :

[0209085P001](#) [10TQ045](#) [111-4189PBF](#) [111-4190PBF](#) [16-1870-01](#) [16RIA80](#) [1EBN1001AEXUMA1](#) [1ED020I12-B2](#) [1ED020I12B2XUMA1](#)
[1ED020I12-BT](#) [1ED020I12BTXUMA1](#) [1ED020I12-F](#) [1ED020I12-F2](#) [1ED020I12F2XUMA1](#) [1ED020I12FA2](#) [1ED020I12FA2XUMA2](#)
[1ED020I12-FT](#) [1ED020I12FTA](#) [1ED020I12FTAXUMA2](#) [1ED3120MU12HXUMA1](#) [1ED3121MU12HXUMA1](#) [1ED3122MC12HXUMA1](#)
[1ED3122MU12HXUMA1](#) [1ED3123MU12HXUMA1](#) [1ED3124MC12HXUMA1](#) [1ED3124MU12HXUMA1](#) [1ED3131MU12HXUMA1](#)
[1ED3140MU12FXUMA1](#) [1ED3141MU12FXUMA1](#) [1ED3142MU12FXUMA1](#) [1ED3241MC12HXUMA1](#) [1ED3321MC12NXUMA1](#)
[1ED3323MC12NXUMA1](#) [1ED3431MU12MXUMA1](#) [1ED3461MU12MXUMA1](#) [1ED3491MC12MXUMA1](#) [1ED3491MU12MXUMA1](#)
[1ED3860MU12MXUMA1](#) [1ED3890MU12MXUMA1](#) [1ED44173N01BXTSA1](#) [1ED44175N01BXTSA1](#) [1ED44176N01FXUMA1](#)
[1EDB7275F](#) [1EDB7275FXUMA1](#) [1EDB8275FXUMA1](#) [1EDB9275FXUMA1](#) [1EDC05I12AHXUMA1](#) [1EDC10I12MHXUMA1](#)
[1EDC20H12AH](#) [1EDC20H12AHXUMA1](#)