

## MOSFET

### 600V CoolMOS™ SJ S7A Power Device

IPQC60R040S7A is a high voltage power MOSFET, designed as static switch according to the superjunction (SJ) principle pioneered by Infineon Technologies.

IPQC60R040S7A combines the experience of the leading SJ MOSFET supplier with high class innovation enabling low  $R_{DS(on)}$  in QDPAK package. The S7A series is optimised for low frequency switching and high current application like circuit breakers.

### Features

- Optimized for low switching frequency in high-end applications (circuit breakers and diode paralleling/replacement in bridge rectifiers).
- S7A technology enables best in class  $R_{DS(on)}$  in smallest footprint.
- Kelvin Source pin improves switching performance at high current.
- QDPAK bottom side cooling package is MSL1 compliant, total Pb-free and suitable for standard PCB assembling flow.

### Benefits

- S7A enabling low  $R_{DS(on)}$  for high constant current.
- Increased performance by using MOSFET instead of diode in the application (e.g. synchronous rectification).
- S7A technology enables 40mΩ  $R_{DS(on)}$  in a compact footprint.
- Reduced parasitic source inductance by Kelvin Source improves stability for extreme high current handling and ease of use due to less ringing.
- Improved thermals enable SMD QDPAK package to be used in high current designs.

### Potential applications

Circuit breakers (HV Battery disconnect switch, DC and AC low frequency switch, HV E-fuse) and diode paralleling/replacement for high power/performance applications.

### Product validation

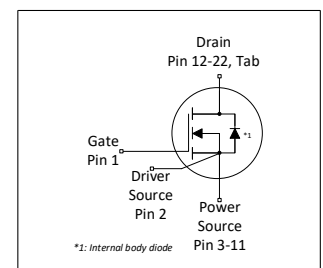
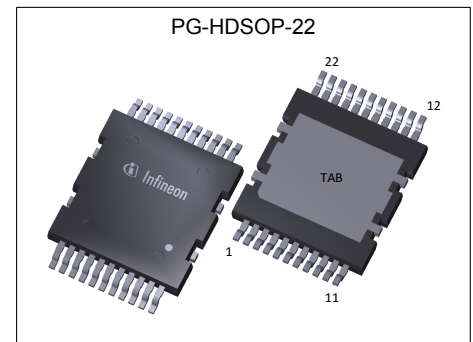
Qualified according to AEC Q101

*Please note: The source and sense source pins are not exchangeable. Their exchange might lead to malfunction. For paralleling 4pin MOSFET devices the placement of the gate resistor is generally recommended to be on the Driver Source instead of the Gate. For production part approval process (PPAP) release we propose to share application related information during an early design phase to avoid delays in PPAP release. Please contact Infineon sales office.*

**Table 1 Key Performance Parameters**

Parameter	Value	Unit
$R_{DS(on),max}$	40	mΩ
$Q_{g,typ}$	83	nC
$V_{SD}$	0.82	V
Pulsed $I_{SD}, I_{DS}$	207	A

Type / Ordering Code	Package	Marking	Related Links
IPQC60R040S7A	PG-HDSOP-22	60A040S7	see Appendix A



RoHS

## Table of Contents

Description .....	1
Maximum ratings .....	3
Thermal characteristics .....	4
Electrical characteristics .....	5
Electrical characteristics diagrams .....	7
Test Circuits .....	11
Package Outlines .....	12
Appendix A .....	13
Revision History .....	14
Trademarks .....	14
Disclaimer .....	14

## 1 Maximum ratings

at  $T_j = 25^\circ\text{C}$ , unless otherwise specified

**Table 2 Maximum ratings**

Parameter	Symbol	Values			Unit	Note / Test Condition
		Min.	Typ.	Max.		
Drain current rating	$I_D$	-	-	14	A	$T_C=140^\circ\text{C}$ Current is limited by $T_{j\max} = 150^\circ\text{C}$ ; Lower case temp does increase current capability
Pulsed drain current <sup>1)</sup>	$I_{D,\text{pulse}}$	-	-	207	A	$T_C=25^\circ\text{C}$
Avalanche energy, single pulse	$E_{AS}$	-	-	159	mJ	$I_D=2.8\text{A}$ ; $V_{DD}=50\text{V}$ ; see table 10
Avalanche current, single pulse	$I_{AS}$	-	-	2.8	A	-
MOSFET dv/dt ruggedness <sup>2)</sup>	dv/dt	-	-	20	V/ns	$V_{DS}=0\text{V to }300\text{V}$
Gate source voltage (static)	$V_{GS}$	-20	-	20	V	static
Gate source voltage (dynamic)	$V_{GS}$	-30	-	30	V	AC ( $f>1\text{ Hz}$ )
Power dissipation	$P_{\text{tot}}$	-	-	272	W	$T_C=25^\circ\text{C}$
Storage temperature	$T_{\text{stg}}$	-55	-	150	$^\circ\text{C}$	-
Operating junction temperature	$T_j$	-40	-	150	$^\circ\text{C}$	-
Extended operating junction temperature	$T_j$	150	-	175	$^\circ\text{C}$	$\leq 50\text{ h}$ in the application lifetime
Mounting torque	-	-	-	n.a.	Ncm	-
Diode forward current rating	$I_S$	-	-	14	A	$T_C=140^\circ\text{C}$ Current is limited by $T_{j\max} = 150^\circ\text{C}$ ; Lower case temp does increase current capability
Diode pulse current <sup>1)</sup>	$I_{S,\text{pulse}}$	-	-	207	A	$T_C=25^\circ\text{C}$
Reverse diode dv/dt <sup>3)</sup>	dv/dt	-	-	5	V/ns	$V_{DS}=0\text{ to }300\text{V}$ , $I_{SD}\leq 13\text{A}$ , $T_j=25^\circ\text{C}$ see table 8
Maximum diode commutation speed	$di/dt$	-	-	1000	A/ $\mu\text{s}$	$V_{DS}=0\text{ to }300\text{V}$ , $I_{SD}\leq 13\text{A}$ , $T_j=25^\circ\text{C}$ see table 8
Insulation withstand voltage	$V_{\text{ISO}}$	-	-	n.a.	V	$V_{\text{rms}}$ , $T_C=25^\circ\text{C}$ , $t=1\text{min}$

<sup>1)</sup> Pulse width  $t_p$  limited by  $T_{j\max}$

<sup>2)</sup> The dv/dt has to be limited by appropriate gate resistor

<sup>3)</sup> Identical low side and high side switch

## 2 Thermal characteristics

**Table 3 Thermal characteristics**

Parameter	Symbol	Values			Unit	Note / Test Condition
		Min.	Typ.	Max.		
Thermal resistance, junction - case	$R_{thJC}$	-	-	0.46	°C/W	-
Thermal resistance, junction - ambient	$R_{thJA}$	-	-	62	°C/W	device on PCB, minimal footprint
Thermal resistance, junction - ambient for SMD version	$R_{thJA}$	-	45	55	°C/W	Device on 40mm*40mm*1.5mm epoxy PCB FR4 with 6cm <sup>2</sup> (one layer, 70µm thickness) copper area. Tap exposed to air. PCB is vertical without air stream cooling.
Soldering temperature, reflow soldering allowed	$T_{sold}$	-	-	260	°C	reflow MSL1

### 3 Electrical characteristics

at  $T_j=25^\circ\text{C}$ , unless otherwise specified

**Table 4 Static characteristics**

The CoolMOS mentioned in this datasheet shall not be operated in linear mode.

For any questions in this regard, please contact Infineon sales office.

For applications with applied blocking voltage >70% of the specified blocking voltage, it is required that the customer evaluates the impact of cosmic radiation effect in early design phase and contacts the Infineon sales office for the necessary technical support by Infineon

Parameter	Symbol	Values			Unit	Note / Test Condition
		Min.	Typ.	Max.		
Drain-source breakdown voltage	$V_{(BR)DSS}$	600	-	-	V	$V_{GS}=0V, I_D=1mA$
Gate threshold voltage	$V_{(GS)th}$	3.5	4.0	4.5	V	$V_{DS}=V_{GS}, I_D=0.79mA$
Zero gate voltage drain current	$I_{DSS}$	-	-	2	$\mu A$	$V_{DS}=600V, V_{GS}=0V, T_j=25^\circ C$ $V_{DS}=600V, V_{GS}=0V, T_j=150^\circ C$
Gate-source leakage current	$I_{GSS}$	-	-	100	nA	$V_{GS}=20V, V_{DS}=0V$
Drain-source on-state resistance	$R_{DS(on)}$	-	0.036	0.040	$\Omega$	$V_{GS}=12V, I_D=13A, T_j=25^\circ C$ $V_{GS}=12V, I_D=13A, T_j=150^\circ C$
Gate resistance	$R_G$	-	0.8	-	$\Omega$	$f=1MHz, \text{open drain}$

**Table 5 Dynamic characteristics**

External parasitic elements (PCB layout) influence switching behavior significantly.

Stray inductances and coupling capacitances must be minimized.

For layout recommendations please use provided application notes or contact Infineon sales office.

Parameter	Symbol	Values			Unit	Note / Test Condition
		Min.	Typ.	Max.		
Input capacitance	$C_{iss}$	-	3128	-	pF	$V_{GS}=0V, V_{DS}=300V, f=250kHz$
Output capacitance	$C_{oss}$	-	50	-	pF	$V_{GS}=0V, V_{DS}=300V, f=250kHz$
Effective output capacitance, energy related <sup>1)</sup>	$C_{o(er)}$	-	168	-	pF	$V_{GS}=0V, V_{DS}=0 \text{ to } 300V$
Effective output capacitance, time related <sup>2)</sup>	$C_{o(tr)}$	-	1476	-	pF	$I_D=\text{constant}, V_{GS}=0V, V_{DS}=0 \text{ to } 300V$
Output charge	$Q_{oss}$	-	443	-	nC	$V_{GS}=0V, V_{DS}=0 \text{ to } 300V$
Turn-on delay time	$t_{d(on)}$	-	23	-	ns	$V_{DD}=300V, V_{GS}=13V, I_D=13A, R_G=8.0\Omega; \text{ see table 9}$
Rise time	$t_r$	-	5	-	ns	$V_{DD}=300V, V_{GS}=13V, I_D=13A, R_G=8.0\Omega; \text{ see table 9}$
Turn-off delay time	$t_{d(off)}$	-	120	-	ns	$V_{DD}=300V, V_{GS}=13V, I_D=13A, R_G=8.0\Omega; \text{ see table 9}$
Fall time	$t_f$	-	9	-	ns	$V_{DD}=300V, V_{GS}=13V, I_D=13A, R_G=8.0\Omega; \text{ see table 9}$

<sup>1)</sup>  $C_{o(er)}$  is a fixed capacitance that gives the same stored energy as  $C_{oss}$  while  $V_{DS}$  is rising from 0 to 300V

<sup>2)</sup>  $C_{o(tr)}$  is a fixed capacitance that gives the same charging time as  $C_{oss}$  while  $V_{DS}$  is rising from 0 to 300V

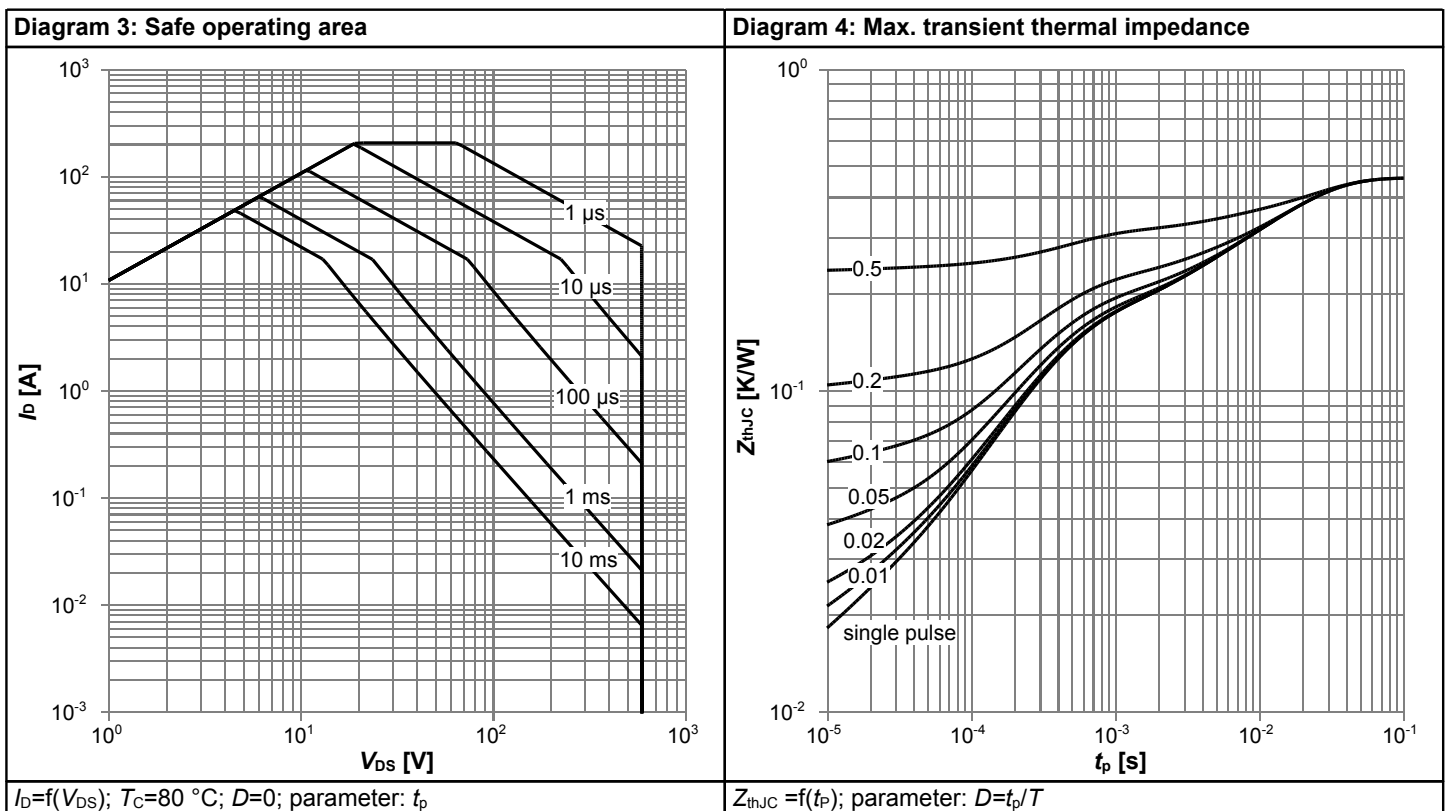
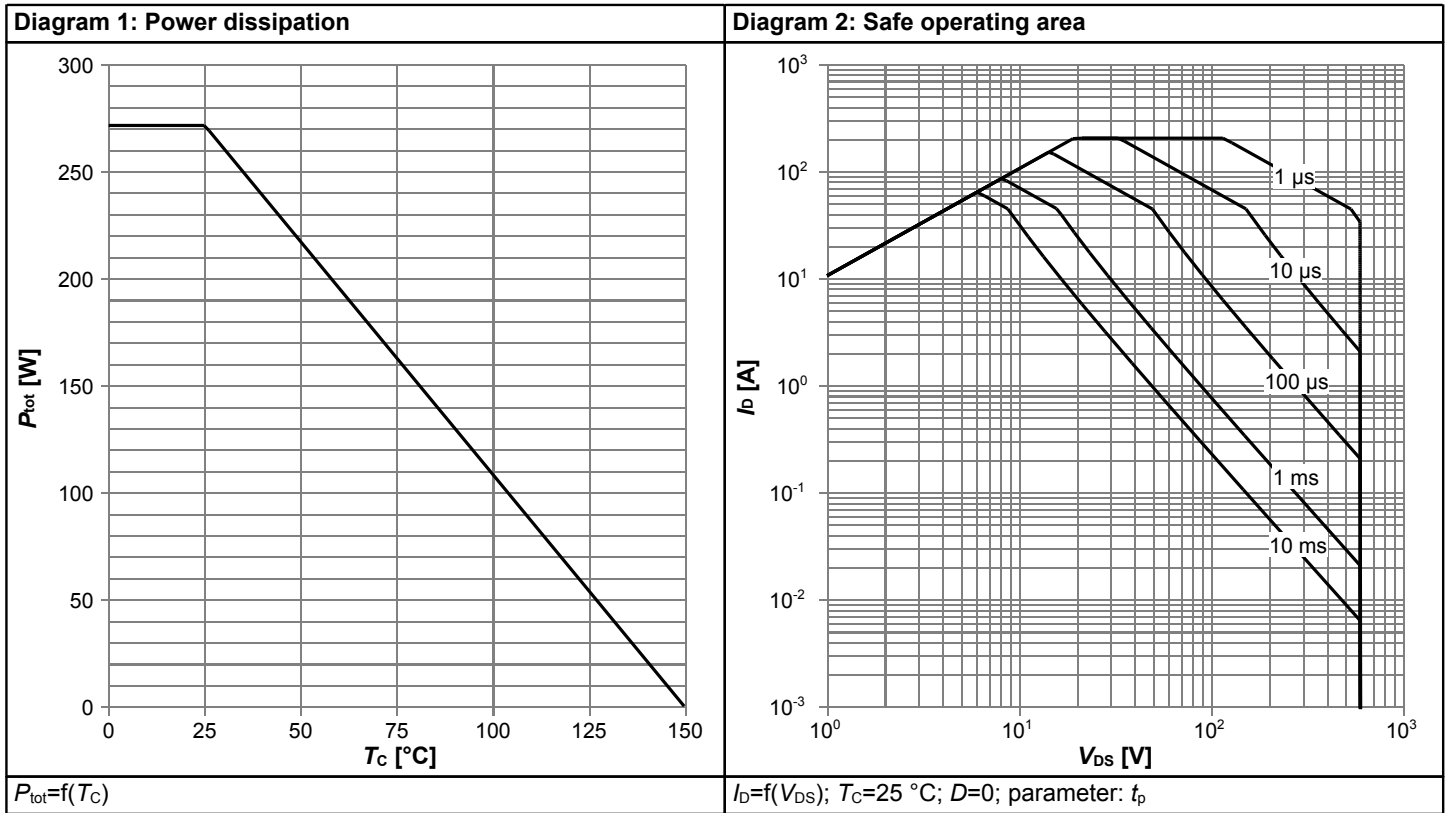
**Table 6 Gate charge characteristics**

Parameter	Symbol	Values			Unit	Note / Test Condition
		Min.	Typ.	Max.		
Gate to source charge	$Q_{gs}$	-	17	-	nC	$V_{DD}=300V, I_D=13A, V_{GS}=0$ to 12V
Gate to drain charge	$Q_{gd}$	-	28	-	nC	$V_{DD}=300V, I_D=13A, V_{GS}=0$ to 12V
Gate charge total	$Q_g$	-	83	-	nC	$V_{DD}=300V, I_D=13A, V_{GS}=0$ to 12V
Gate plateau voltage	$V_{plateau}$	-	5.4	-	V	$V_{DD}=300V, I_D=13A, V_{GS}=0$ to 12V

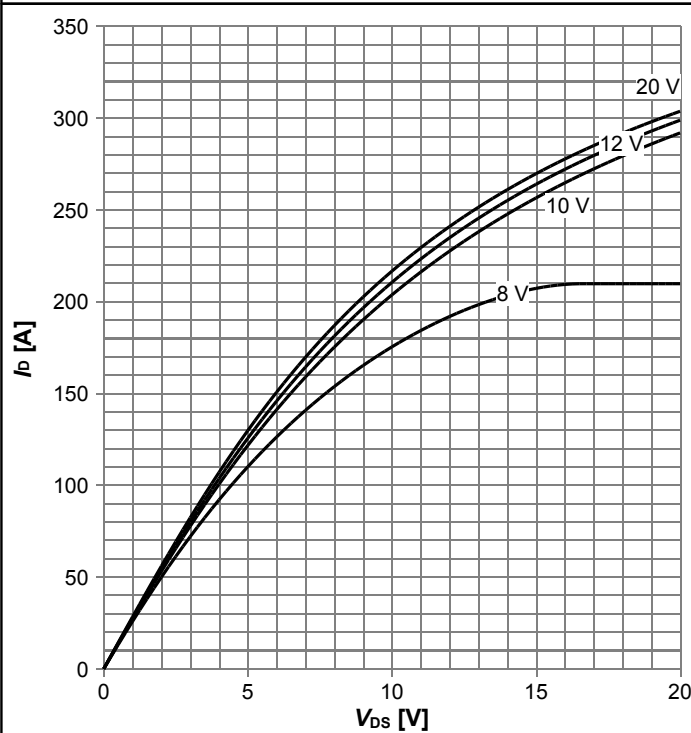
**Table 7 Reverse diode characteristics**

Parameter	Symbol	Values			Unit	Note / Test Condition
		Min.	Typ.	Max.		
Diode forward voltage	$V_{SD}$	-	0.82	-	V	$V_{GS}=0V, I_F=13A, T_j=25^\circ C$
Reverse recovery time	$t_{rr}$	-	360	-	ns	$V_R=300V, I_F=13A, di_F/dt=100A/\mu s$ ; see table 8
Reverse recovery charge	$Q_{rr}$	-	5.5	-	$\mu C$	$V_R=300V, I_F=13A, di_F/dt=100A/\mu s$ ; see table 8
Peak reverse recovery current	$I_{rrm}$	-	32	-	A	$V_R=300V, I_F=13A, di_F/dt=100A/\mu s$ ; see table 8

### 4 Electrical characteristics diagrams

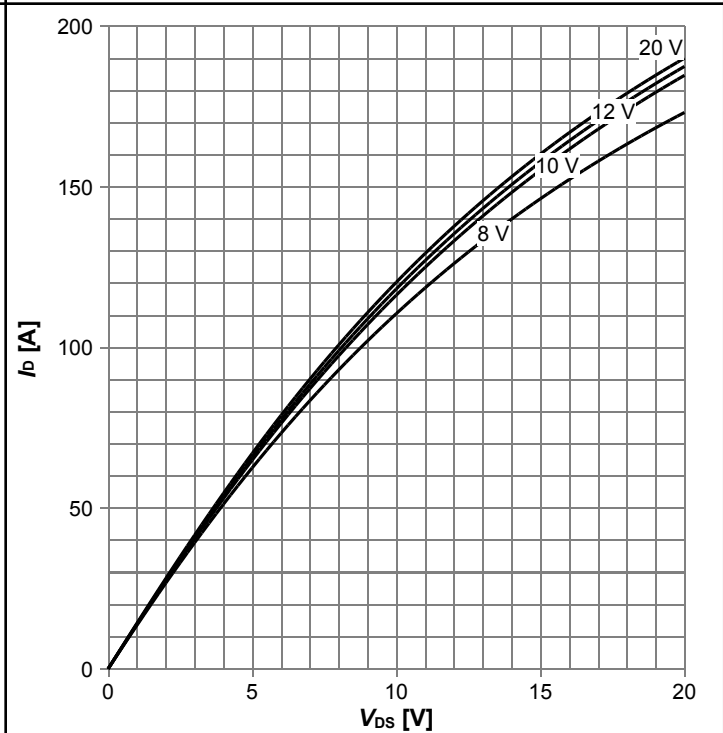


**Diagram 5: Typ. output characteristics**



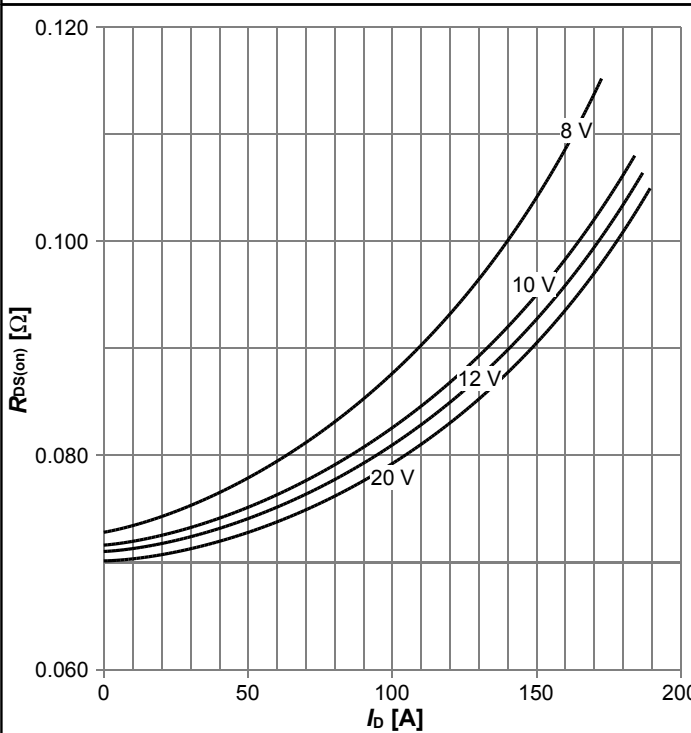
$I_D=f(V_{DS}); T_j=25\text{ °C}; \text{parameter: } V_{GS}$

**Diagram 6: Typ. output characteristics**



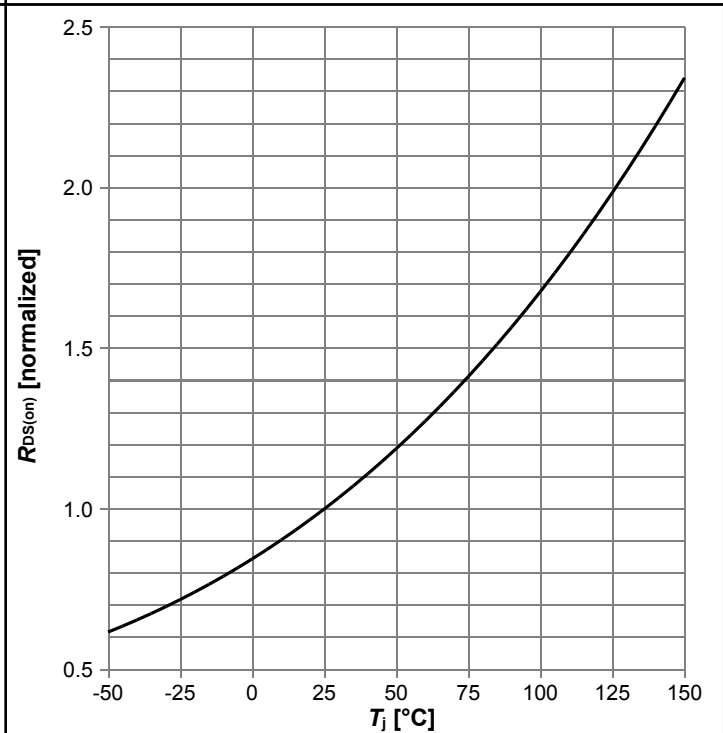
$I_D=f(V_{DS}); T_j=125\text{ °C}; \text{parameter: } V_{GS}$

**Diagram 7: Typ. drain-source on-state resistance**



$R_{DS(on)}=f(I_D); T_j=125\text{ °C}; \text{parameter: } V_{GS}$

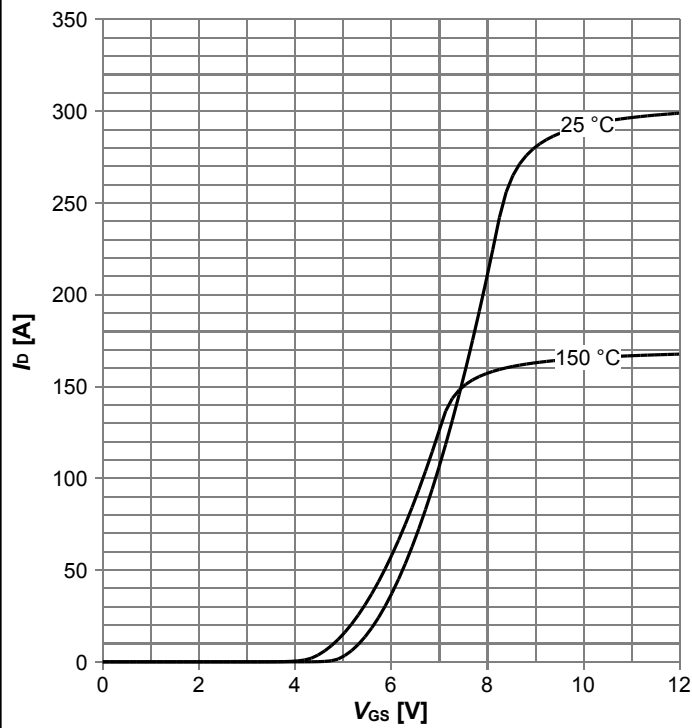
**Diagram 8: Drain-source on-state resistance**



$R_{DS(on)}=f(T_j); I_D=13\text{ A}; V_{GS}=12\text{ V}$

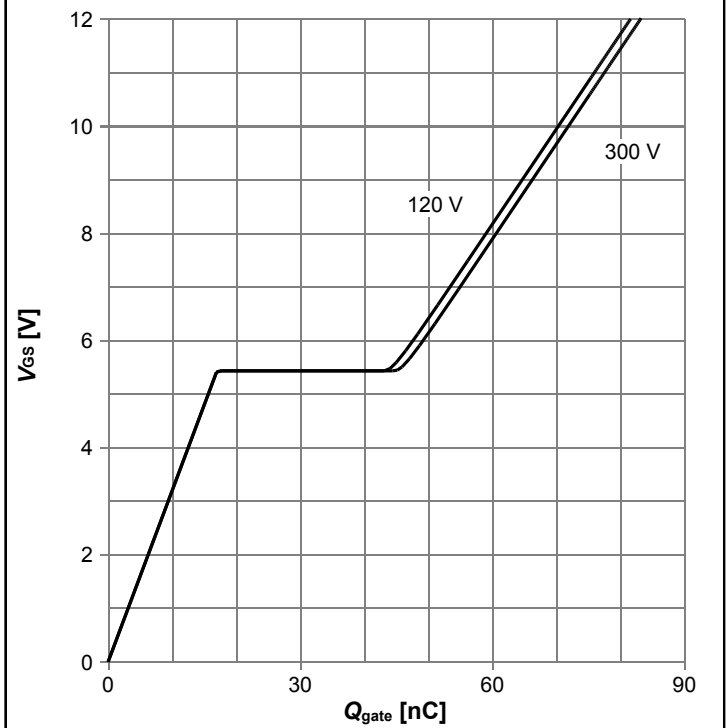


Diagram 9: Typ. transfer characteristics



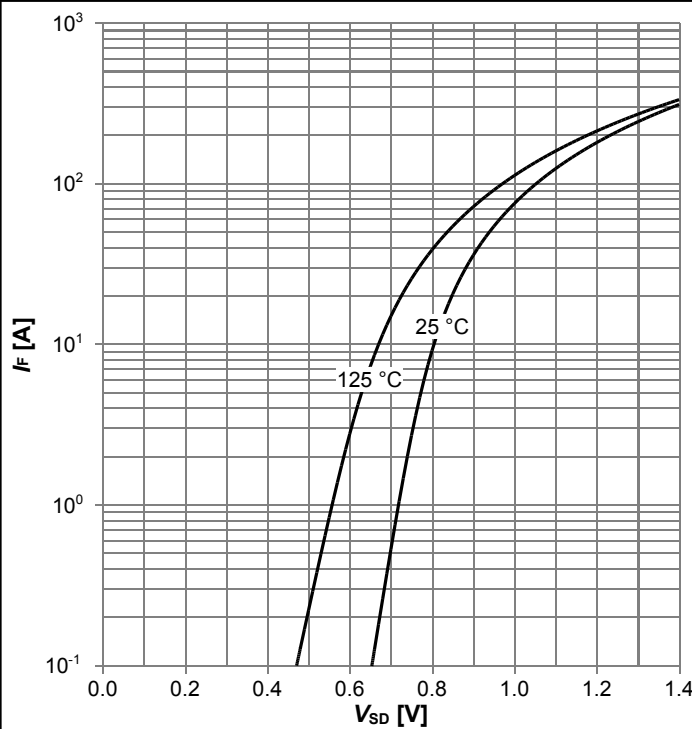
$I_D=f(V_{GS}); V_{DS}=20V$ ; parameter:  $T_j$

Diagram 10: Typ. gate charge



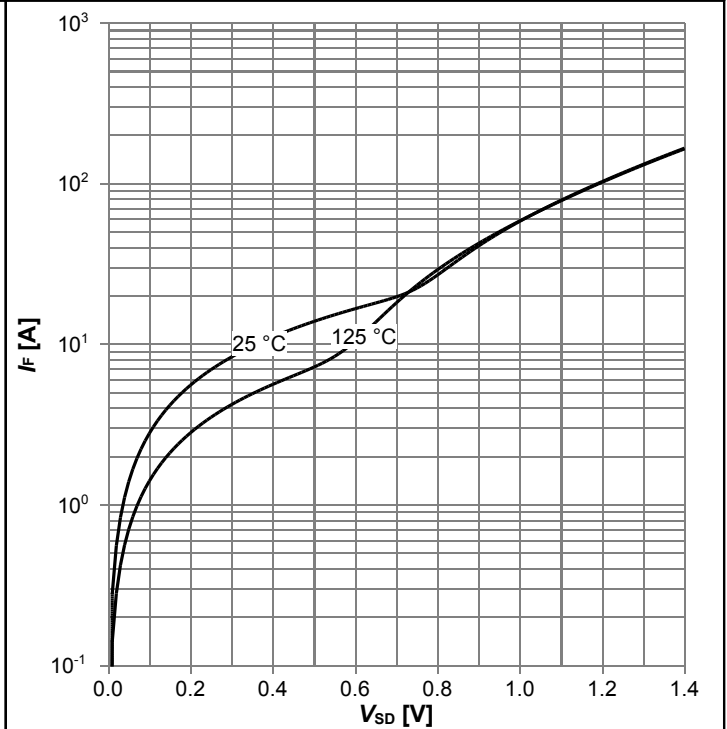
$V_{GS}=f(Q_{gate}); I_D=13\text{ A pulsed}$ ; parameter:  $V_{DD}$

Diagram 11: Forward characteristics of reverse diode



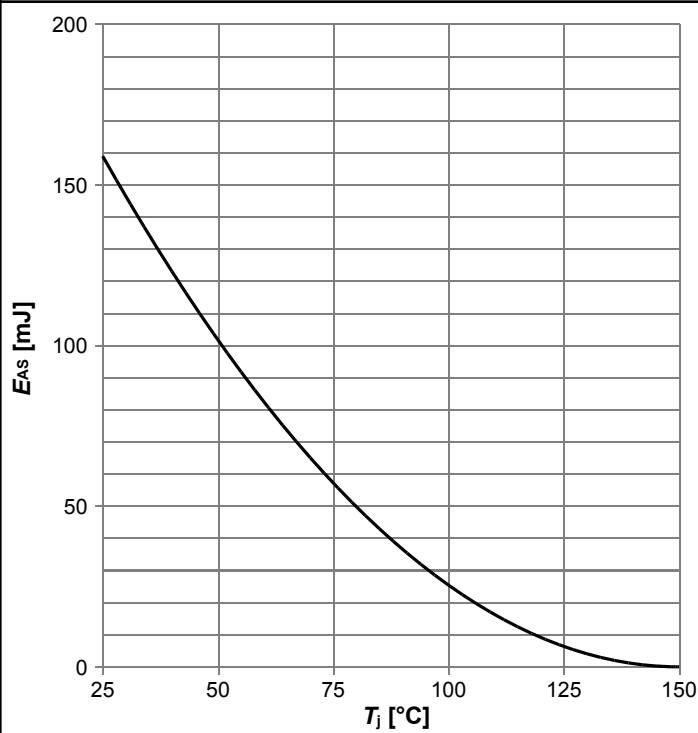
$I_F=f(V_{SD}); V_{GS}=0\text{ V}$ ; parameter:  $T_j$

Diagram 12: Forward characteristics of reverse diode



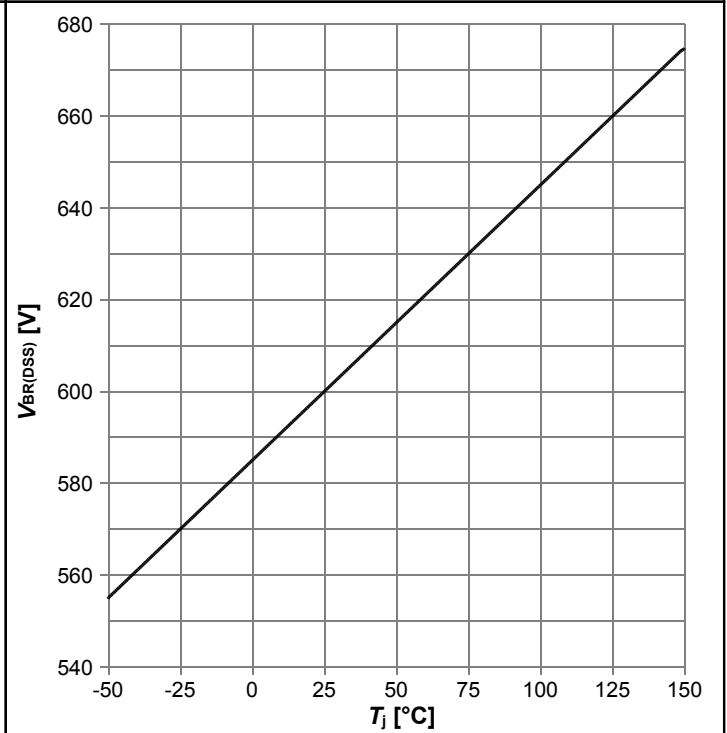
$I_F=f(V_{SD}); V_{GS}=12\text{ V}$ ; parameter:  $T_j$

Diagram 13: Avalanche energy



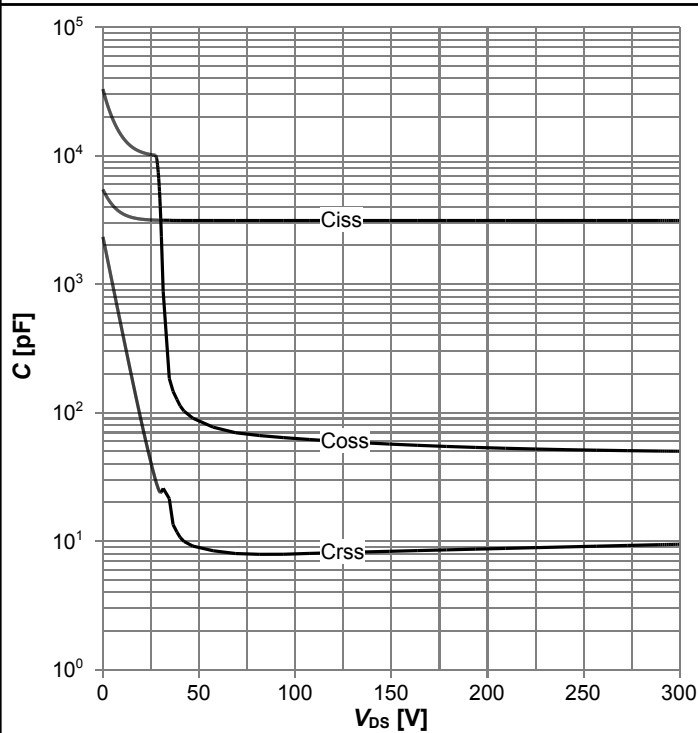
$E_{AS}=f(T_j)$ ;  $I_D=2.8$  A;  $V_{DD}=50$  V

Diagram 14: Drain-source breakdown voltage



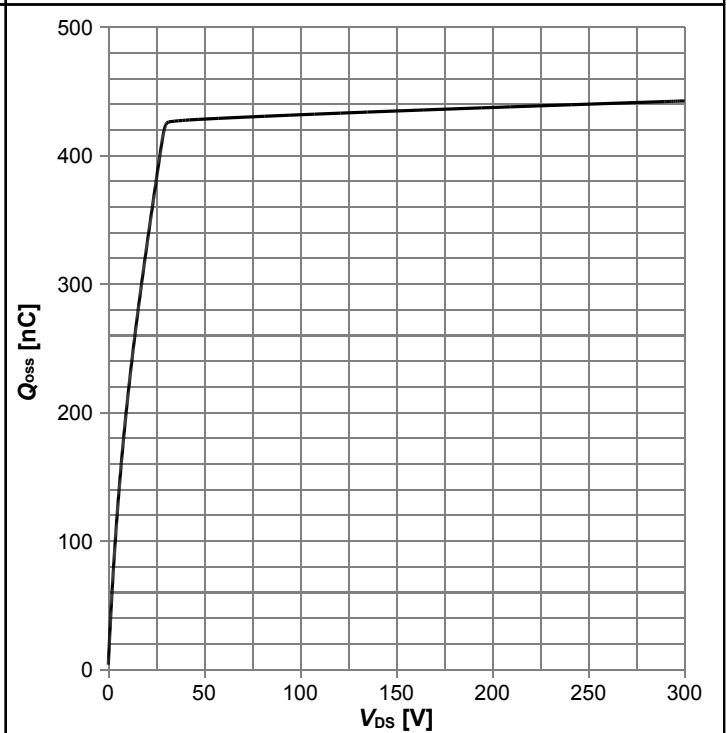
$V_{BR(DSS)}=f(T_j)$ ;  $I_D=1$  mA

Diagram 15: Typ. capacitances



$C=f(V_{DS})$ ;  $V_{GS}=0$  V;  $f=250$  kHz

Diagram 17: Typ. Q\_oss output charge



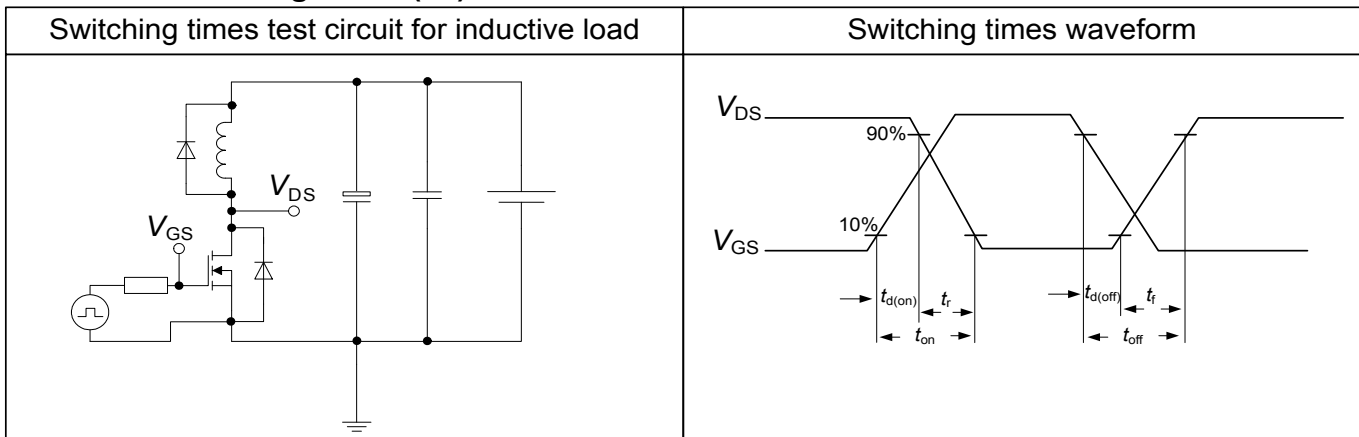
$Q_{oss}=f(V_{DS})$ ;  $V_{GS}=0$  V

## 5 Test Circuits

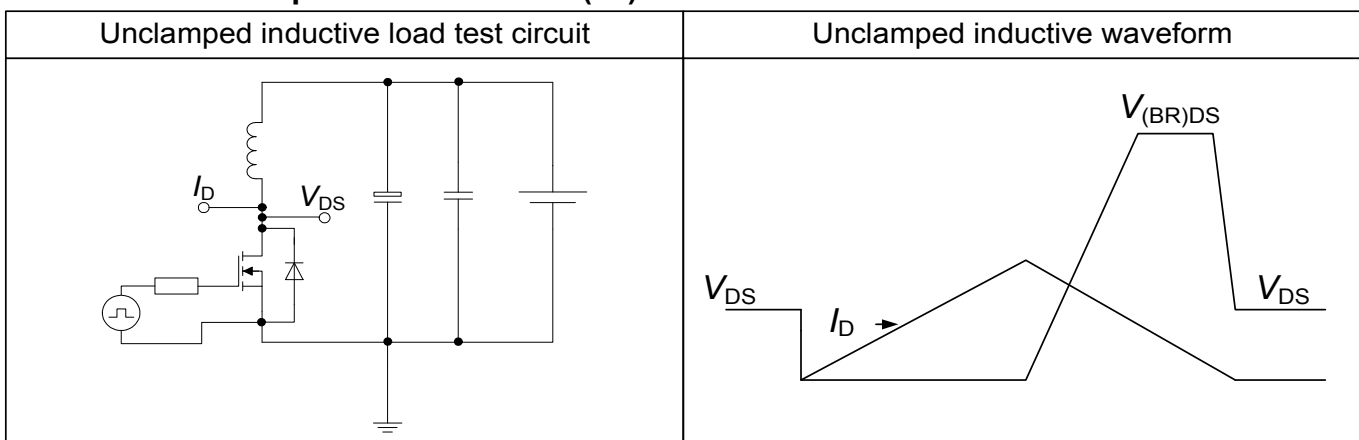
**Table 8 Diode characteristics**



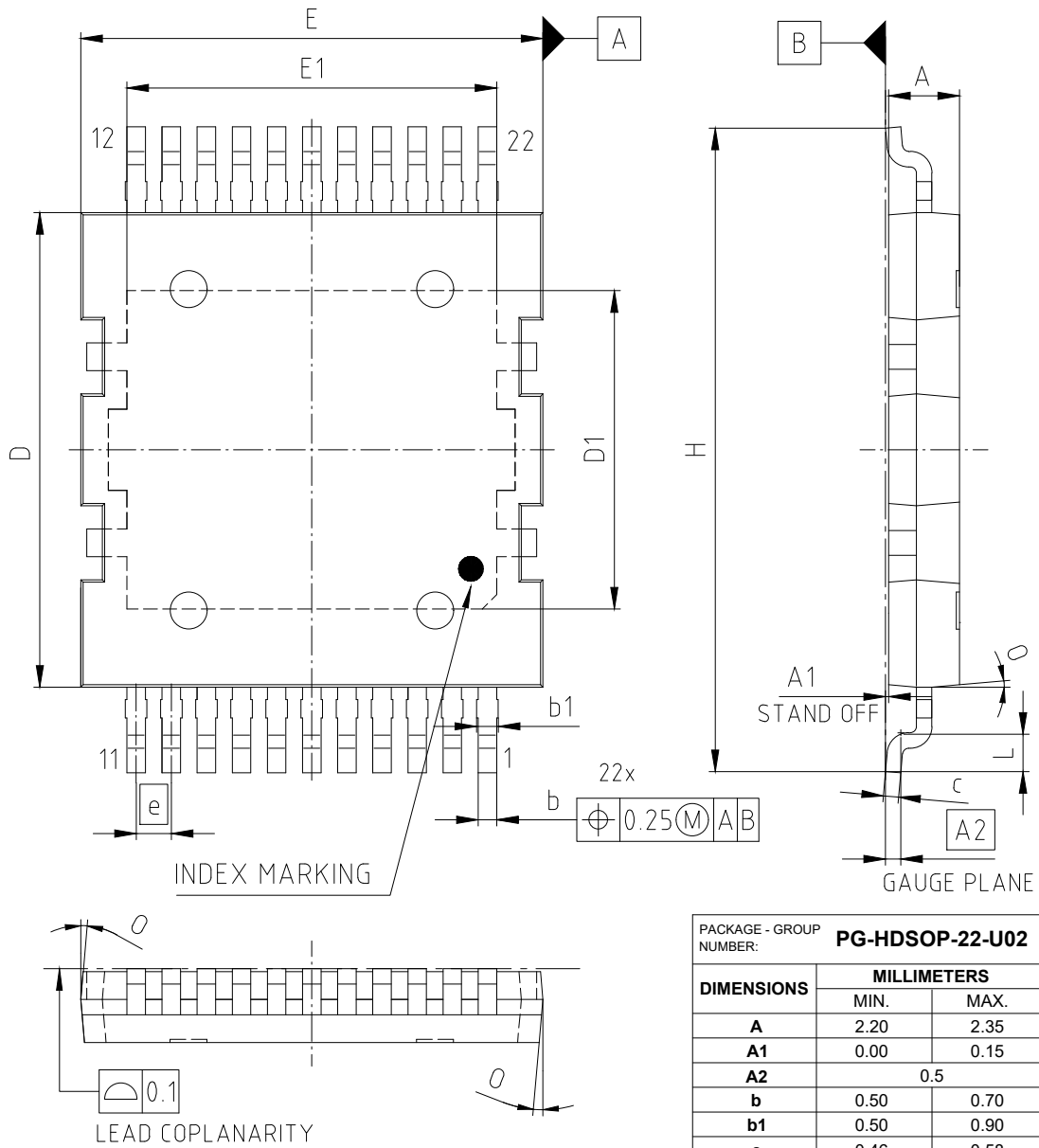
**Table 9 Switching times (ss)**



**Table 10 Unclamped inductive load (ss)**



## 6 Package Outlines



**Figure 1 Outline PG-HDSOP-22, dimensions in mm**

## **7 Appendix A**

### **Table 11 Related Links**

- **IFX CoolMOS S7 Webpage:** [www.infineon.com](http://www.infineon.com)
- **IFX CoolMOS S7 application note:** [www.infineon.com](http://www.infineon.com)
- **IFX CoolMOS S7 simulation model:** [www.infineon.com](http://www.infineon.com)
- **IFX Design tools:** [www.infineon.com](http://www.infineon.com)

## Revision History

IPQC60R040S7A

**Revision: 2022-11-23, Rev. 2.0**

Previous Revision

Revision	Date	Subjects (major changes since last revision)
2.0	2022-11-23	Release of final version

### Trademarks

All referenced product or service names and trademarks are the property of their respective owners.

### Disclaimer

#### We Listen to Your Comments

Any information within this document that you feel is wrong, unclear or missing at all? Your feedback will help us to continuously improve the quality of this document. Please send your proposal (including a reference to this document) to:

[erratum@infineon.com](mailto:erratum@infineon.com)

#### Published by

**Infineon Technologies AG**

**81726 München, Germany**

**© 2022 Infineon Technologies AG**

**All Rights Reserved.**

#### Legal Disclaimer

The information given in this document shall in no event be regarded as a guarantee of conditions or characteristics ("Beschaffenhheitsgarantie").

With respect to any examples, hints or any typical values stated herein and/or any information regarding the application of the product, Infineon Technologies hereby disclaims any and all warranties and liabilities of any kind, including without limitation warranties of non-infringement of intellectual property rights of any third party.

In addition, any information given in this document is subject to customer's compliance with its obligations stated in this document and any applicable legal requirements, norms and standards concerning customer's products and any use of the product of Infineon Technologies in customer's applications.

The data contained in this document is exclusively intended for technically trained staff. It is the responsibility of customer's technical departments to evaluate the suitability of the product for the intended application and the completeness of the product information given in this document with respect to such application.

#### Information

For further information on technology, delivery terms and conditions and prices please contact your nearest Infineon Technologies Office ([www.infineon.com](http://www.infineon.com)).

#### Warnings

Due to technical requirements components may contain dangerous substances. For information on the types in question please contact your nearest Infineon Technologies Office.

Infineon Technologies Components may only be used in life-support devices or systems with the express written approval of Infineon Technologies, if a failure of such components can reasonably be expected to cause the failure of that life-support device or system, or to affect the safety or effectiveness of that device or system. Life support devices or systems are intended to be implanted in the human body, or to support and/or maintain and sustain and/or protect human life.

If they fail, it is reasonable to assume that the health of the user or other persons may be endangered.

## X-ON Electronics

Largest Supplier of Electrical and Electronic Components

*Click to view similar products for [Infineon manufacturer](#):*

Other Similar products are found below :

[0209085P001](#) [10TQ045](#) [111-4189PBF](#) [111-4190PBF](#) [16-1870-01](#) [16RIA80](#) [1EBN1001AEXUMA1](#) [1ED020I12-B2](#) [1ED020I12B2XUMA1](#)  
[1ED020I12-BT](#) [1ED020I12BTXUMA1](#) [1ED020I12-F](#) [1ED020I12-F2](#) [1ED020I12F2XUMA1](#) [1ED020I12FA2](#) [1ED020I12FA2XUMA2](#)  
[1ED020I12-FT](#) [1ED020I12FTA](#) [1ED020I12FTAXUMA2](#) [1ED3120MU12HXUMA1](#) [1ED3121MU12HXUMA1](#) [1ED3122MC12HXUMA1](#)  
[1ED3122MU12HXUMA1](#) [1ED3123MU12HXUMA1](#) [1ED3124MC12HXUMA1](#) [1ED3124MU12HXUMA1](#) [1ED3131MU12HXUMA1](#)  
[1ED3140MU12FXUMA1](#) [1ED3141MU12FXUMA1](#) [1ED3142MU12FXUMA1](#) [1ED3241MC12HXUMA1](#) [1ED3321MC12NXUMA1](#)  
[1ED3323MC12NXUMA1](#) [1ED3431MU12MXUMA1](#) [1ED3461MU12MXUMA1](#) [1ED3491MC12MXUMA1](#) [1ED3491MU12MXUMA1](#)  
[1ED3860MU12MXUMA1](#) [1ED3890MU12MXUMA1](#) [1ED44173N01BXTSA1](#) [1ED44175N01BXTSA1](#) [1ED44176N01FXUMA1](#)  
[1EDB7275F](#) [1EDB7275FXUMA1](#) [1EDB8275FXUMA1](#) [1EDB9275FXUMA1](#) [1EDC05I12AHXUMA1](#) [1EDC10I12MHXUMA1](#)  
[1EDC20H12AH](#) [1EDC20H12AHXUMA1](#)