

## MOSFET

Metal Oxide Semiconductor Field Effect Transistor

## CoolMOS™ C7

600V CoolMOS™ C7 Power Transistor  
IPW60R060C7

## Data Sheet

Rev. 2.0  
Final

## 1 Description

CoolMOS™ C7 is a revolutionary technology for high voltage power MOSFETs, designed according to the superjunction (SJ) principle and pioneered by Infineon Technologies.

600V CoolMOS™ C7 series combines the experience of the leading SJ MOSFET supplier with high class innovation.

The 600V C7 is the first technology ever with  $R_{DS(on)} \cdot A$  below  $10\text{Ohm} \cdot \text{mm}^2$ .

### Features

- Suitable for hard and soft switching (PFC and high performance LLC)
- Increased MOSFET  $dv/dt$  ruggedness to  $120\text{V/ns}$
- Increased efficiency due to best in class FOM  $R_{DS(on)} \cdot E_{oss}$  and  $R_{DS(on)} \cdot Q_g$
- Best in class  $R_{DS(on)}$  /package
- Qualified for industrial grade applications according to JEDEC (J-STD20 and JESD22)

### Benefits

- Increased economies of scale by use in PFC and PWM topologies in the application
- Higher  $dv/dt$  limit enables faster switching leading to higher efficiency
- Enabling higher system efficiency by lower switching losses
- Increased power density solutions due to smaller packages
- Suitable for applications such as server, telecom and solar
- Higher switching frequencies possible without loss in efficiency due to low  $E_{oss}$  and  $Q_g$

### Applications

PFC stages and PWM stages (TTF, LLC) for high power/performance SMPS e.g. Computing, Server, Telecom, UPS and Solar.

*Please note: For MOSFET paralleling the use of ferrite beads on the gate or separate totem poles is generally recommended.*

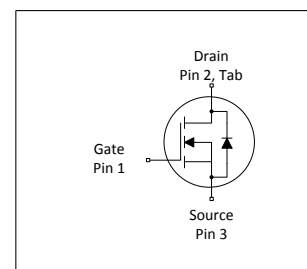
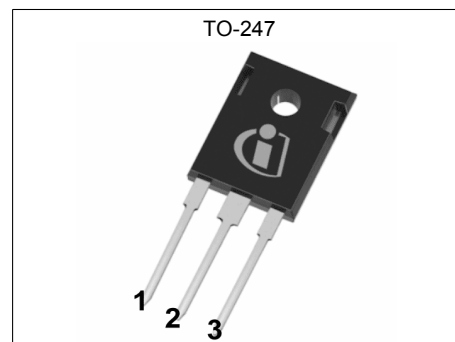

**Table 1 Key Performance Parameters**

Parameter	Value	Unit
$V_{DS} @ T_{j,max}$	650	V
$R_{DS(on),max}$	60	$m\Omega$
$Q_{g,typ}$	68	nC
$I_{D,pulse}$	135	A
$I_{D,continuous} @ T_j < 150^\circ\text{C}$	54	A
$E_{oss}@400\text{V}$	8.1	$\mu\text{J}$
Body diode $di/dt$	420	$\text{A}/\mu\text{s}$

Type / Ordering Code	Package	Marking	Related Links
IPW60R060C7	PG-TO 247	60C7060	see Appendix A

**Table of Contents**

Description .....	2
Maximum ratings .....	4
Thermal characteristics .....	5
Electrical characteristics .....	6
Electrical characteristics diagrams .....	8
Test Circuits .....	12
Package Outlines .....	13
Appendix A .....	14
Revision History .....	15
Disclaimer .....	15

## 2 Maximum ratings

at  $T_j = 25^\circ\text{C}$ , unless otherwise specified

**Table 2 Maximum ratings**

Parameter	Symbol	Values			Unit	Note / Test Condition
		Min.	Typ.	Max.		
Continuous drain current <sup>1)</sup>	$I_D$	-	-	35 22	A	$T_C=25^\circ\text{C}$ $T_C=100^\circ\text{C}$
Pulsed drain current <sup>2)</sup>	$I_{D,pulse}$	-	-	135	A	$T_C=25^\circ\text{C}$
Avalanche energy, single pulse	$E_{AS}$	-	-	159	mJ	$I_D=6.4\text{A}$ ; $V_{DD}=50\text{V}$ ; see table 10
Avalanche energy, repetitive	$E_{AR}$	-	-	0.80	mJ	$I_D=6.4\text{A}$ ; $V_{DD}=50\text{V}$ ; see table 10
Avalanche current, single pulse	$I_{AS}$	-	-	6.4	A	-
MOSFET dv/dt ruggedness	dv/dt	-	-	120	V/ns	$V_{DS}=0\dots400\text{V}$
Gate source voltage (static)	$V_{GS}$	-20	-	20	V	static;
Gate source voltage (dynamic)	$V_{GS}$	-30	-	30	V	AC ( $f>1\text{ Hz}$ )
Power dissipation	$P_{tot}$	-	-	162	W	$T_C=25^\circ\text{C}$
Storage temperature	$T_{stg}$	-55	-	150	$^\circ\text{C}$	-
Operating junction temperature	$T_j$	-55	-	150	$^\circ\text{C}$	-
Mounting torque	-	-	-	60	Ncm	M3 and M3.5 screws
Continuous diode forward current	$I_S$	-	-	35	A	$T_C=25^\circ\text{C}$
Diode pulse current <sup>2)</sup>	$I_{S,pulse}$	-	-	135	A	$T_C=25^\circ\text{C}$
Reverse diode dv/dt <sup>3)</sup>	dv/dt	-	-	20	V/ns	$V_{DS}=0\dots400\text{V}$ , $I_{SD}\leq 9.9\text{A}$ , $T_j=25^\circ\text{C}$ see table 8
Maximum diode commutation speed	di/dt	-	-	420	A/ $\mu\text{s}$	$V_{DS}=0\dots400\text{V}$ , $I_{SD}\leq 9.9\text{A}$ , $T_j=25^\circ\text{C}$ see table 8
Insulation withstand voltage	$V_{ISO}$	-	-	n.a.	V	$V_{rms}$ , $T_C=25^\circ\text{C}$ , $t=1\text{min}$

<sup>1)</sup> Limited by  $T_{j,max}$ .

<sup>2)</sup> Pulse width  $t_p$  limited by  $T_{j,max}$

<sup>3)</sup> Identical low side and high side switch

### 3 Thermal characteristics

**Table 3 Thermal characteristics**

Parameter	Symbol	Values			Unit	Note / Test Condition
		Min.	Typ.	Max.		
Thermal resistance, junction - case	$R_{thJC}$	-	-	0.772	°C/W	-
Thermal resistance, junction - ambient	$R_{thJA}$	-	-	62	°C/W	leaded
Thermal resistance, junction - ambient for SMD version	$R_{thJA}$	-	-	-	°C/W	n.a.
Soldering temperature, wavesoldering only allowed at leads	$T_{sold}$	-	-	260	°C	1.6mm (0.063 in.) from case for 10s

## 4 Electrical characteristics

at  $T_j=25^\circ\text{C}$ , unless otherwise specified

**Table 4 Static characteristics**

Parameter	Symbol	Values			Unit	Note / Test Condition
		Min.	Typ.	Max.		
Drain-source breakdown voltage	$V_{(BR)DSS}$	600	-	-	V	$V_{GS}=0\text{V}$ , $I_D=1\text{mA}$
Gate threshold voltage	$V_{(GS)th}$	3	3.5	4	V	$V_{DS}=V_{GS}$ , $I_D=0.8\text{mA}$
Zero gate voltage drain current	$I_{DSS}$	-	-	1	$\mu\text{A}$	$V_{DS}=600$ , $V_{GS}=0\text{V}$ , $T_j=25^\circ\text{C}$ $V_{DS}=600$ , $V_{GS}=0\text{V}$ , $T_j=150^\circ\text{C}$
Gate-source leakage current	$I_{GSS}$	-	-	100	nA	$V_{GS}=20\text{V}$ , $V_{DS}=0\text{V}$
Drain-source on-state resistance	$R_{DS(on)}$	-	0.052 0.115	0.060 -	$\Omega$	$V_{GS}=10\text{V}$ , $I_D=15.9\text{A}$ , $T_j=25^\circ\text{C}$ $V_{GS}=10\text{V}$ , $I_D=15.9\text{A}$ , $T_j=150^\circ\text{C}$
Gate resistance	$R_G$	-	0.8	-	$\Omega$	$f=1\text{MHz}$ , open drain

**Table 5 Dynamic characteristics**

Parameter	Symbol	Values			Unit	Note / Test Condition
		Min.	Typ.	Max.		
Input capacitance	$C_{iss}$	-	2850	-	pF	$V_{GS}=0\text{V}$ , $V_{DS}=400\text{V}$ , $f=250\text{kHz}$
Output capacitance	$C_{oss}$	-	54	-	pF	$V_{GS}=0\text{V}$ , $V_{DS}=400\text{V}$ , $f=250\text{kHz}$
Effective output capacitance, energy related <sup>1)</sup>	$C_{o(er)}$	-	101	-	pF	$V_{GS}=0\text{V}$ , $V_{DS}=0\dots400\text{V}$
Effective output capacitance, time related <sup>2)</sup>	$C_{o(tr)}$	-	1050	-	pF	$I_D=\text{constant}$ , $V_{GS}=0\text{V}$ , $V_{DS}=0\dots400\text{V}$
Turn-on delay time	$t_{d(on)}$	-	15.5	-	ns	$V_{DD}=400\text{V}$ , $V_{GS}=13\text{V}$ , $I_D=15.9\text{A}$ , $R_G=3.3\Omega$ ; see table 9
Rise time	$t_r$	-	11	-	ns	$V_{DD}=400\text{V}$ , $V_{GS}=13\text{V}$ , $I_D=15.9\text{A}$ , $R_G=3.3\Omega$ ; see table 9
Turn-off delay time	$t_{d(off)}$	-	79	-	ns	$V_{DD}=400\text{V}$ , $V_{GS}=13\text{V}$ , $I_D=15.9\text{A}$ , $R_G=3.3\Omega$ ; see table 9
Fall time	$t_f$	-	4	-	ns	$V_{DD}=400\text{V}$ , $V_{GS}=13\text{V}$ , $I_D=15.9\text{A}$ , $R_G=3.3\Omega$ ; see table 9

**Table 6 Gate charge characteristics**

Parameter	Symbol	Values			Unit	Note / Test Condition
		Min.	Typ.	Max.		
Gate to source charge	$Q_{gs}$	-	14	-	nC	$V_{DD}=400\text{V}$ , $I_D=15.9\text{A}$ , $V_{GS}=0$ to $10\text{V}$
Gate to drain charge	$Q_{gd}$	-	23	-	nC	$V_{DD}=400\text{V}$ , $I_D=15.9\text{A}$ , $V_{GS}=0$ to $10\text{V}$
Gate charge total	$Q_g$	-	68	-	nC	$V_{DD}=400\text{V}$ , $I_D=15.9\text{A}$ , $V_{GS}=0$ to $10\text{V}$
Gate plateau voltage	$V_{plateau}$	-	5.0	-	V	$V_{DD}=400\text{V}$ , $I_D=15.9\text{A}$ , $V_{GS}=0$ to $10\text{V}$

<sup>1)</sup>  $C_{o(er)}$  is a fixed capacitance that gives the same stored energy as  $C_{oss}$  while  $V_{DS}$  is rising from 0 to 400V

<sup>2)</sup>  $C_{o(tr)}$  is a fixed capacitance that gives the same charging time as  $C_{oss}$  while  $V_{DS}$  is rising from 0 to 400V

**Table 7 Reverse diode characteristics**

Parameter	Symbol	Values			Unit	Note / Test Condition
		Min.	Typ.	Max.		
Diode forward voltage	$V_{SD}$	-	0.9	-	V	$V_{GS}=0V, I_F=15.9A, T_j=25^{\circ}C$
Reverse recovery time	$t_{rr}$	-	390	-	ns	$V_R=400V, I_F=15.9A, di_F/dt=100A/\mu s$ ; see table 8
Reverse recovery charge	$Q_{rr}$	-	6	-	$\mu C$	$V_R=400V, I_F=15.9A, di_F/dt=100A/\mu s$ ; see table 8
Peak reverse recovery current	$I_{rrm}$	-	32	-	A	$V_R=400V, I_F=15.9A, di_F/dt=100A/\mu s$ ; see table 8

### 5 Electrical characteristics diagrams

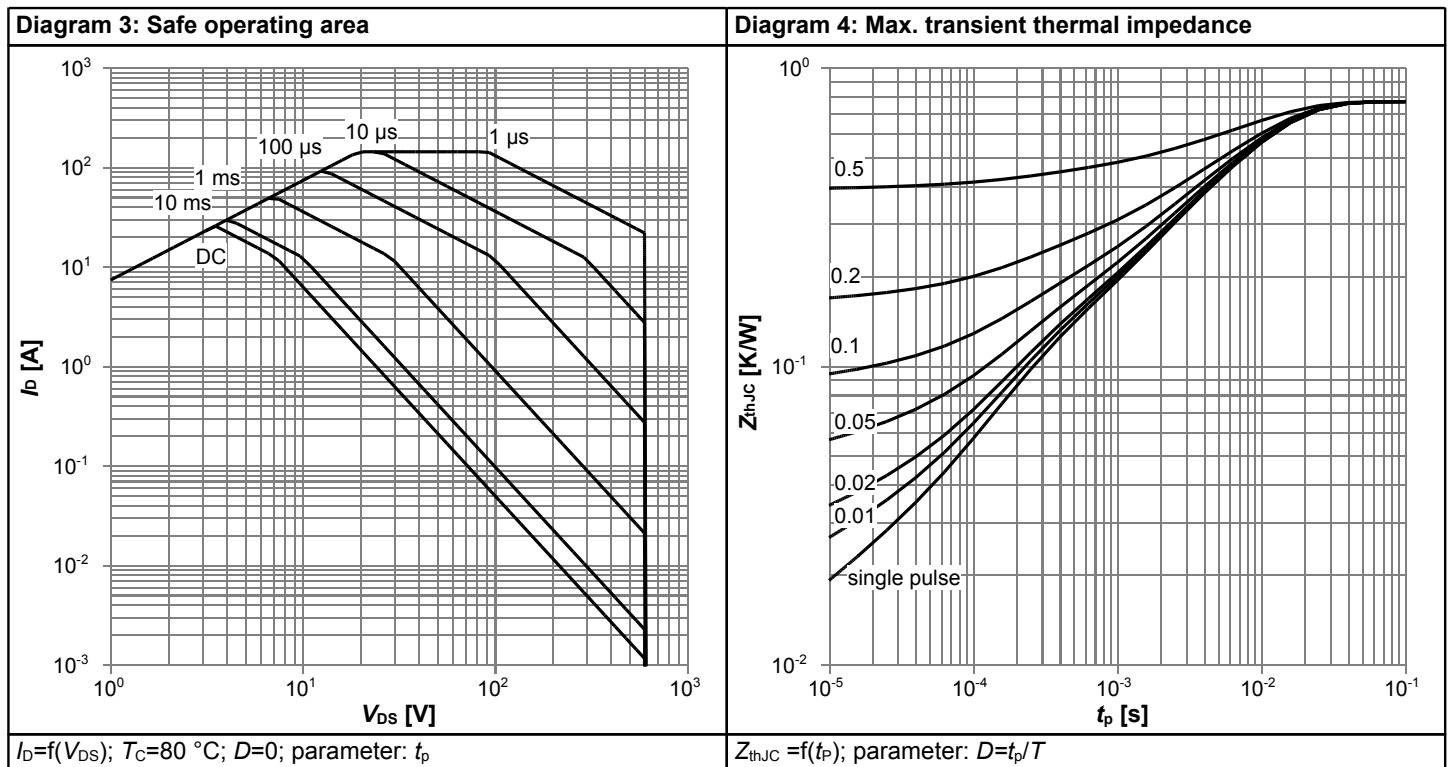
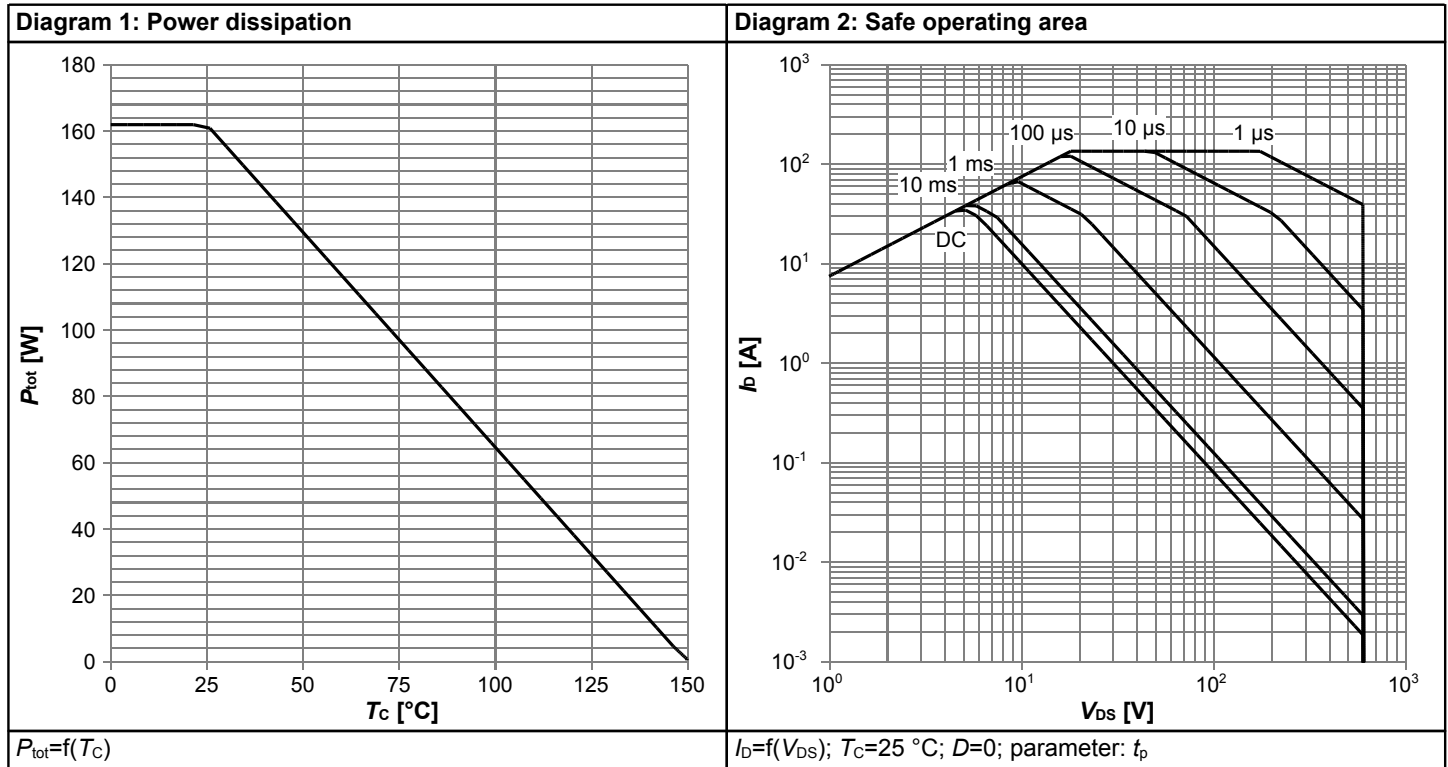
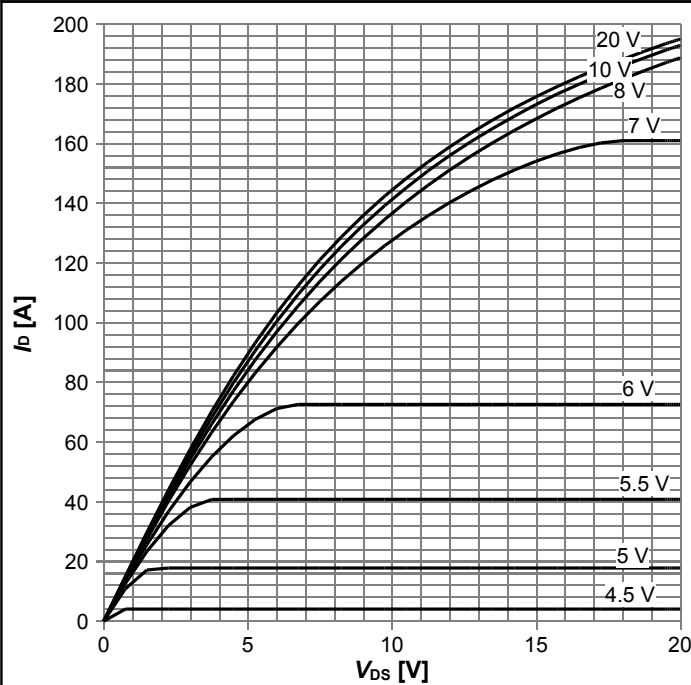

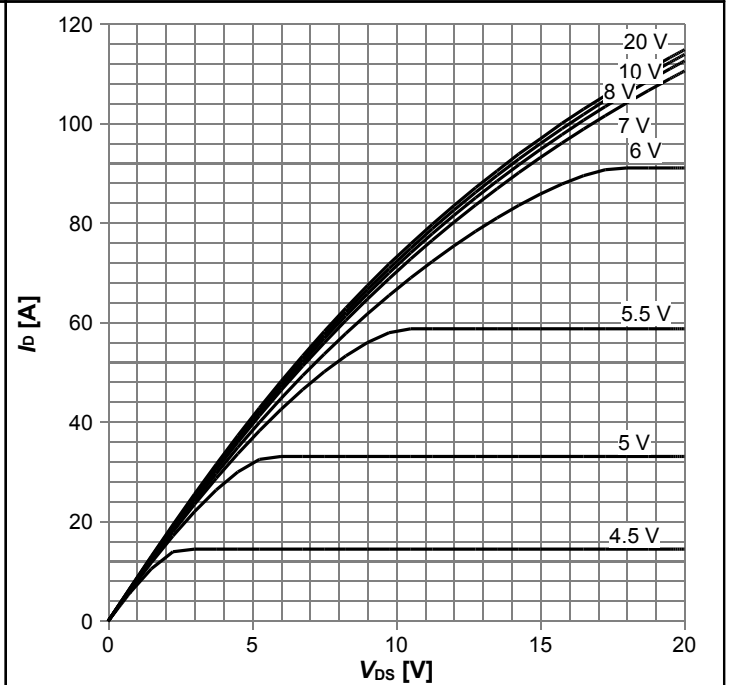

Diagram 5: Typ. output characteristics



$I_D=f(V_{DS}); T_j=25\text{ }^\circ\text{C}; \text{parameter: } V_{GS}$

Diagram 6: Typ. output characteristics



$I_D=f(V_{DS}); T_j=125\text{ }^\circ\text{C}; \text{parameter: } V_{GS}$

Diagram 7: Typ. drain-source on-state resistance

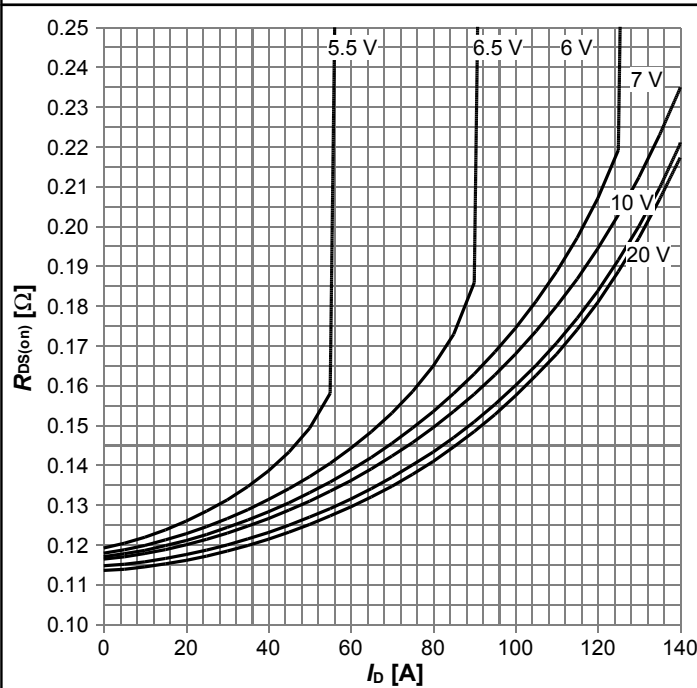

$R_{DS(on)}=f(I_D); T_j=125\text{ }^\circ\text{C}; \text{parameter: } V_{GS}$

Diagram 8: Drain-source on-state resistance

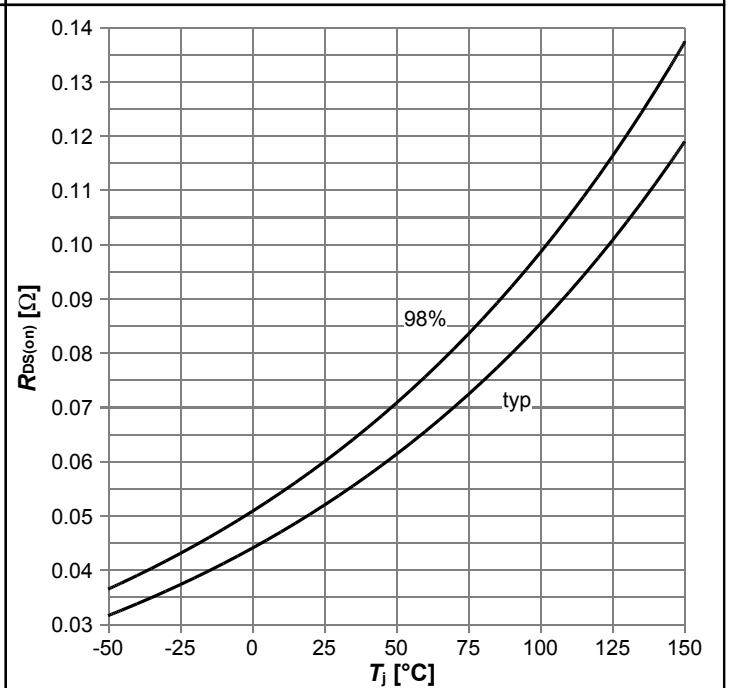

$R_{DS(on)}=f(T_j); I_D=15.9\text{ A}; V_{GS}=10\text{ V}$

**Diagram 9: Typ. transfer characteristics**

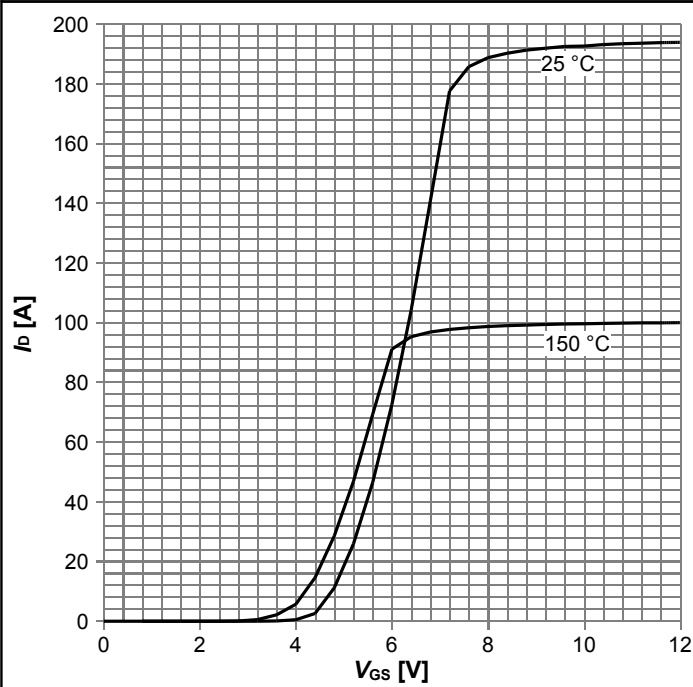

$I_D=f(V_{GS}); V_{DS}=20V; \text{parameter: } T_j$

**Diagram 10: Typ. gate charge**

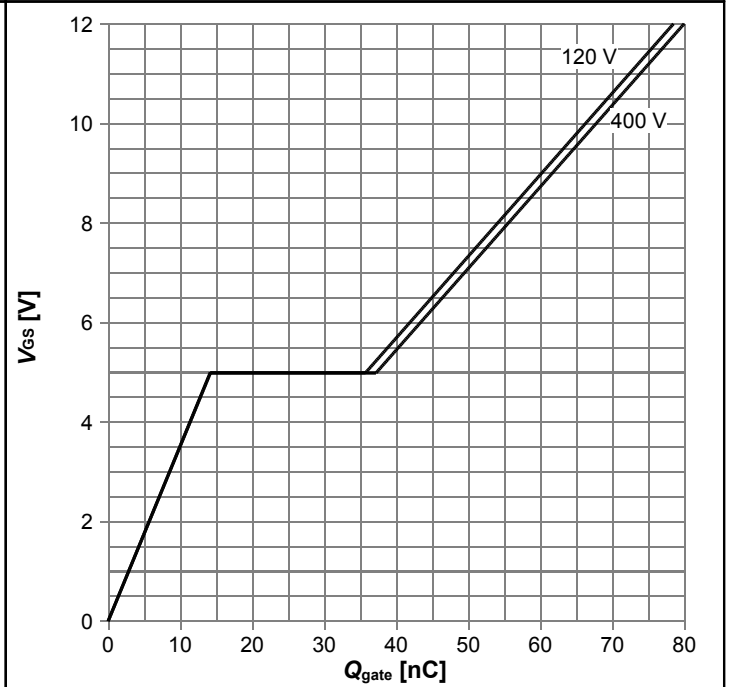

$V_{GS}=f(Q_{gate}); I_D=15.9 \text{ A pulsed}; \text{parameter: } V_{DD}$

**Diagram 11: Forward characteristics of reverse diode**

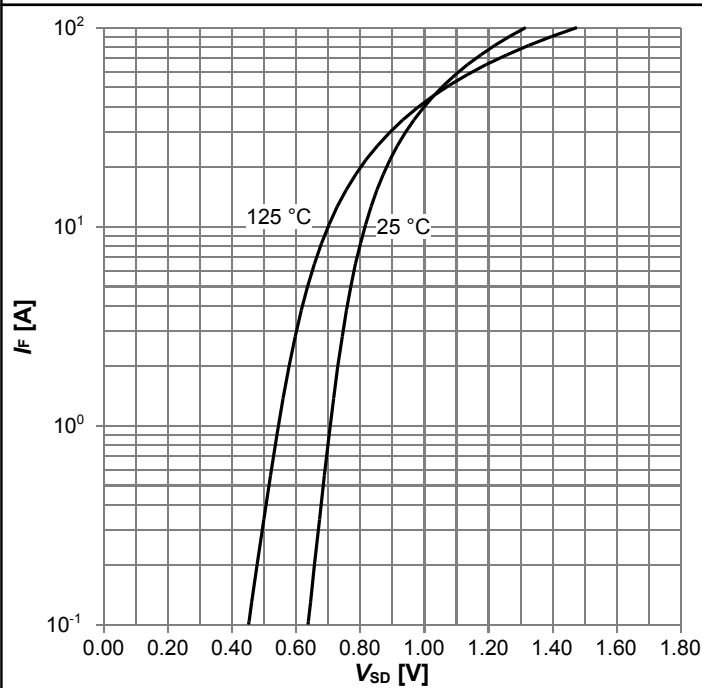

$I_F=f(V_{SD}); \text{parameter: } T_j$

**Diagram 12: Avalanche energy**

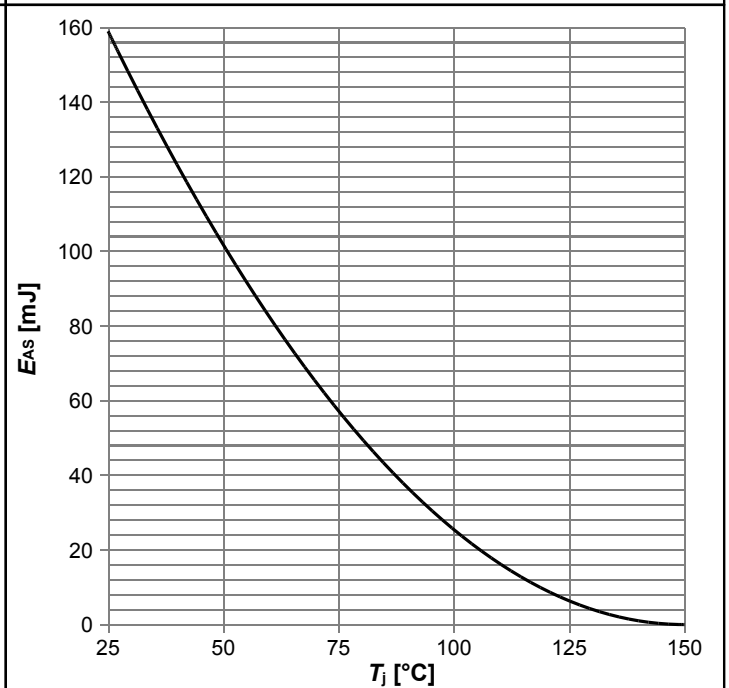

$E_{AS}=f(T_j); I_D=6.4 \text{ A}; V_{DD}=50 \text{ V}$

Diagram 13: Drain-source breakdown voltage

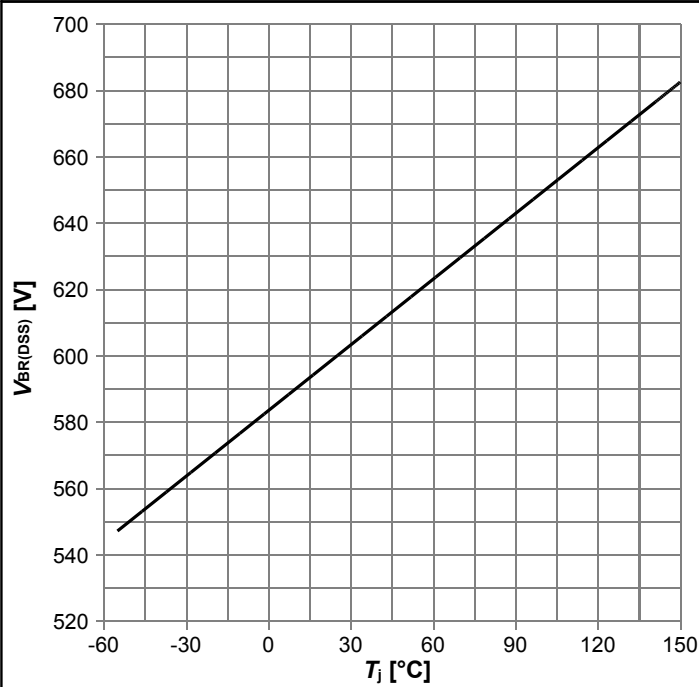

$V_{BR(DSS)}=f(T_j); I_D=1 \text{ mA}$

Diagram 14: Typ. capacitances

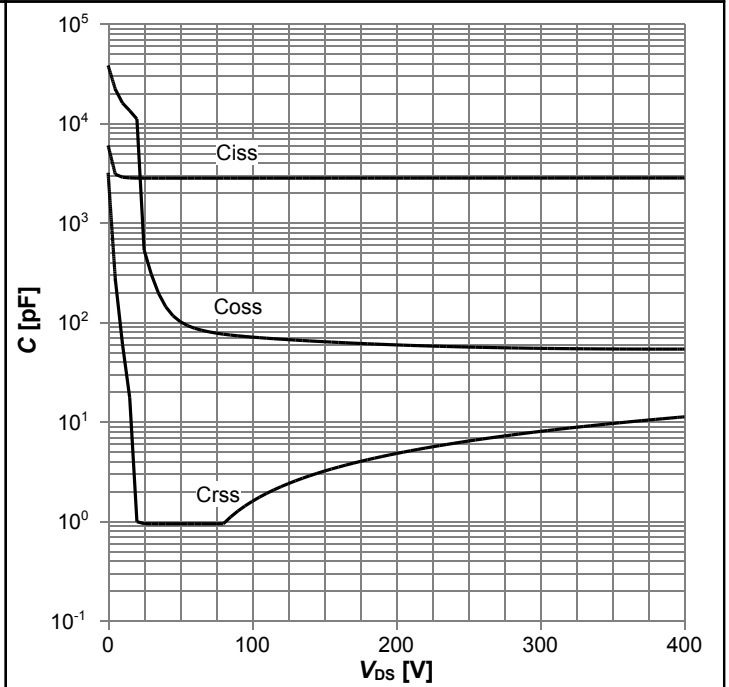

$C=f(V_{DS}); V_{GS}=0 \text{ V}; f=250 \text{ kHz}$

Diagram 15: Typ. Coss stored energy

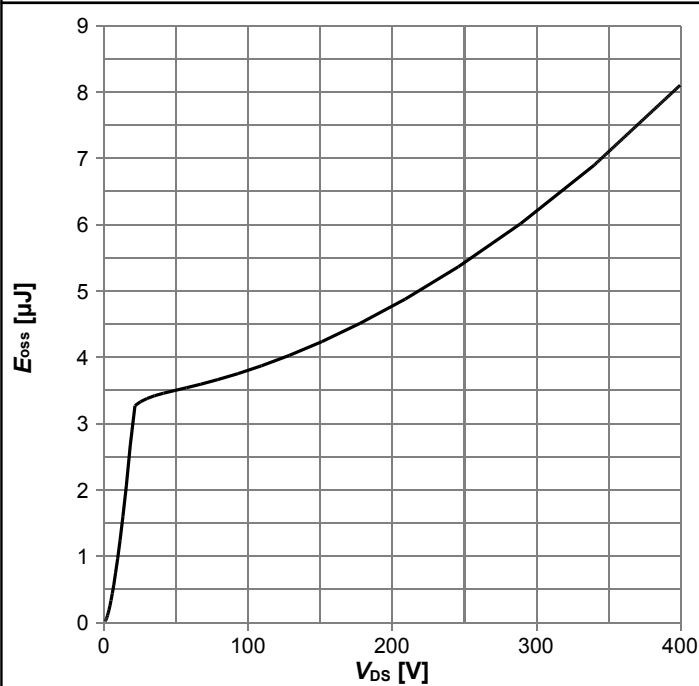

$E_{oss}=f(V_{DS})$

## 6 Test Circuits

**Table 8 Diode characteristics**

Test circuit for diode characteristics	Diode recovery waveform
<p><math>R_{g1} = R_{g2}</math></p>	<p> <math>t_{rr} = t_F + t_S</math>  <math>Q_{rr} = Q_F + Q_S</math> </p>

**Table 9 Switching times**

Switching times test circuit for inductive load	Switching times waveform

**Table 10 Unclamped inductive load**

Unclamped inductive load test circuit	Unclamped inductive waveform

## 7 Package Outlines

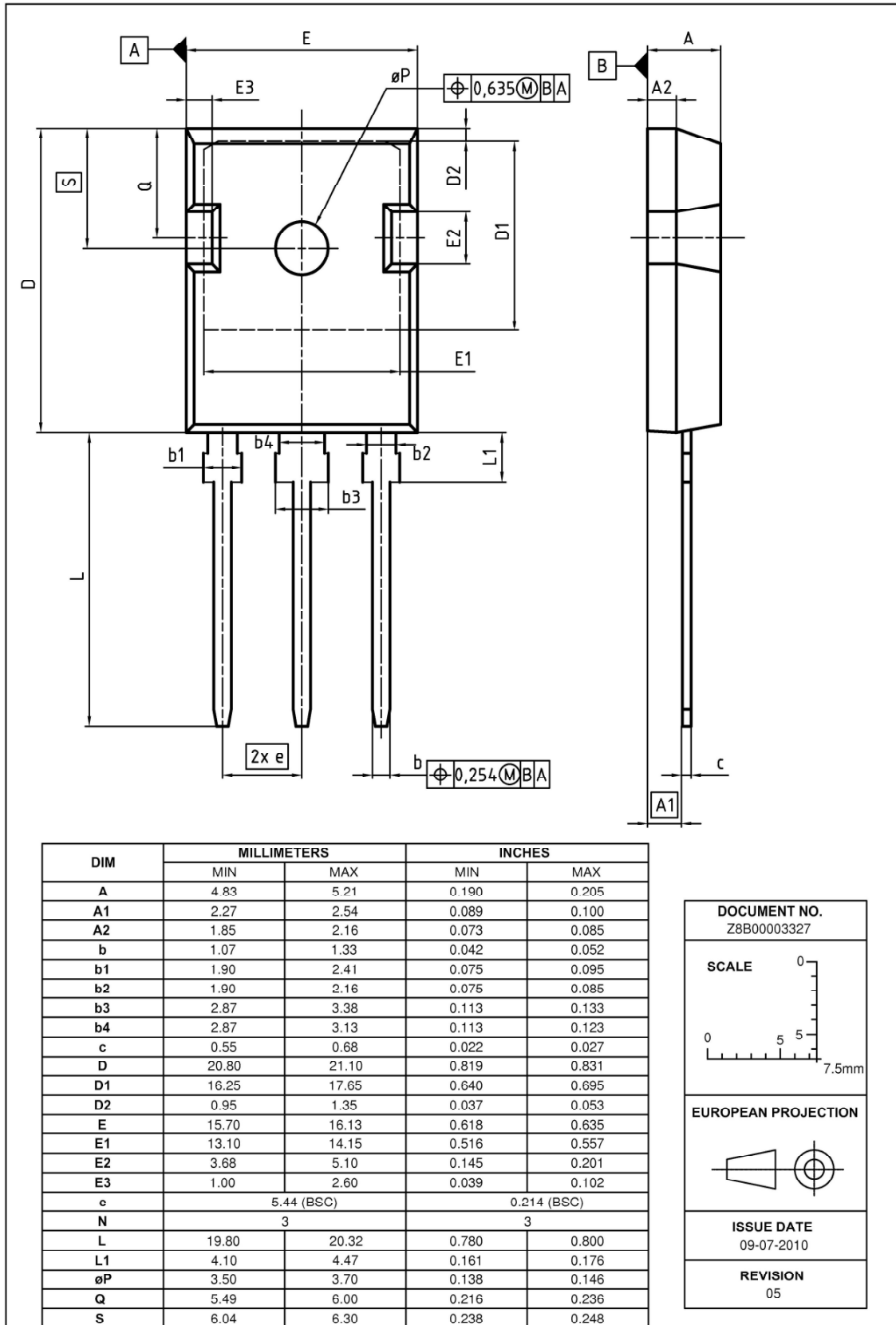

Figure 1 Outline PG-TO 247, dimensions in mm/inches

## 8 Appendix A

### Table 11 Related Links

- IFX CoolMOS™ C7 Webpage: [www.infineon.com](http://www.infineon.com)
- IFX CoolMOS™ C7 application note: [www.infineon.com](http://www.infineon.com)
- IFX CoolMOS™ C7 simulation model: [www.infineon.com](http://www.infineon.com)
- IFX Design tools: [www.infineon.com](http://www.infineon.com)

## Revision History

IPW60R060C7

**Revision: 2015-11-30, Rev. 2.0**

Previous Revision

Revision	Date	Subjects (major changes since last revision)
2.0	2015-11-30	Release of final version

### We Listen to Your Comments

Any information within this document that you feel is wrong, unclear or missing at all? Your feedback will help us to continuously improve the quality of this document. Please send your proposal (including a reference to this document) to:

[erratum@infineon.com](mailto:erratum@infineon.com)

### Published by

**Infineon Technologies AG**

**81726 München, Germany**

**© 2015 Infineon Technologies AG**

**All Rights Reserved.**

### Legal Disclaimer

The information given in this document shall in no event be regarded as a guarantee of conditions or characteristics. With respect to any examples or hints given herein, any typical values stated herein and/or any information regarding the application of the device, Infineon Technologies hereby disclaims any and all warranties and liabilities of any kind, including without limitation, warranties of non-infringement of intellectual property rights of any third party.

### Information

For further information on technology, delivery terms and conditions and prices please contact your nearest Infineon Technologies Office ([www.infineon.com](http://www.infineon.com)).

### Warnings

Due to technical requirements, components may contain dangerous substances. For information on the types in question, please contact the nearest Infineon Technologies Office.

The Infineon Technologies component described in this Data Sheet may be used in life-support devices or systems and/or automotive, aviation and aerospace applications or systems only with the express written approval of Infineon Technologies, if a failure of such components can reasonably be expected to cause the failure of that life-support, automotive, aviation and aerospace device or system or to affect the safety or effectiveness of that device or system. Life support devices or systems are intended to be implanted in the human body or to support and/or maintain and sustain and/or protect human life. If they fail, it is reasonable to assume that the health of the user or other persons may be endangered.

## X-ON Electronics

Largest Supplier of Electrical and Electronic Components

*Click to view similar products for [MOSFET](#) category:*

*Click to view products by [Infineon](#) manufacturer:*

Other Similar products are found below :

[614233C](#) [648584F](#) [IRFD120](#) [JANTX2N5237](#) [FCA20N60\\_F109](#) [FDZ595PZ](#) [2SK2545\(Q,T\)](#) [405094E](#) [423220D](#) [TPCC8103,L1Q\(CM](#)  
[MIC4420CM-TR](#) [VN1206L](#) [614234A](#) [715780A](#) [NTNS3166NZT5G](#) [SSM6J414TU,LF\(T](#) [751625C](#) [BUK954R8-60E](#) [GROUP A 5962-](#)  
[8877003PA](#) [NTE6400](#) [SQJ402EP-T1-GE3](#) [2SK2614\(TE16L1,Q\)](#) [2N7002KW-FAI](#) [DMN1017UCP3-7](#) [EFC2J004NUZTDG](#) [ECH8691-TL-W](#)  
[FCAB21350L1](#) [P85W28HP2F-7071](#) [DMN1053UCP4-7](#) [NTE221](#) [NTE222](#) [NTE2384](#) [NTE2903](#) [NTE2941](#) [NTE2945](#) [NTE2946](#) [NTE2960](#)  
[NTE2967](#) [NTE2969](#) [NTE2976](#) [NTE6400A](#) [NTE2910](#) [NTE2916](#) [NTE2956](#) [NTE2911](#) [DMN2080UCB4-7](#) [TK10A80W,S4X\(S](#)  
[SSM6P69NU,LF](#) [DMP22D4UFO-7B](#) [DMN1006UCA6-7](#)