

---

## Sup/IRBuck™

### USER GUIDE FOR IRDC3846 EVALUATION BOARD

#### DESCRIPTION

The IR3846 is a synchronous buck converter, providing a compact, high performance and flexible solution in a small 5mmx7mm QFN package.

Key features offered by the IR3846 include internal Digital Soft Start, precision 0.6V reference voltage, Power Good, thermal protection, programmable switching frequency, Enable input, input under-voltage lockout for proper start-up, enhanced line/load regulation with feed forward, external frequency synchronization with smooth clocking, internal LDO, true differential remote sensing and pre-bias start-up.

A thermally compensated output over-current protection function is implemented by sensing the voltage developed across the on-resistance of the synchronous rectifier MOSFET for optimum cost and performance.

This user guide contains the schematic and bill of materials for the IRDC3846 evaluation board. The guide describes operation and use of the evaluation board itself. Detailed application information for IR3846 is available in the IR3846 data sheet.

---

#### BOARD FEATURES

- $V_{in} = +12V$ , **No Vcc required.**
- $V_{out} = +1.2V @ 0-35A$
- $F_s = 600kHz$
- $L = 0.250uH$
- $C_{in} = 7 \times 22uF$  (ceramic 1206) +  $1 \times 330uF$  (electrolytic)
- $C_{out} = 6 \times 100uF$  (ceramic 1206)

**CONNECTIONS and OPERATING INSTRUCTIONS**

A well regulated +12V input supply should be connected to VIN+ and VIN-. A maximum of 35A load should be connected to VOUT+ and VOUT-. The inputs and output connections of the board are listed in Table I.

IR3846 needs only one input supply and internal LDO generates Vcc from Vin. If operation with external Vcc is required, then R3 should be removed and external Vcc can be applied between Vcc+ and Vcc- pins. Vin pin and Vcc pins should be shorted together for external Vcc operation by installing a 0 ohm resistor at R4.

The board is configured for remote sensing. If local sense is desired, R18 should be uninstalled and R19 should be installed instead.

External Enable signal can be applied to the board via exposed Enable pad and *R100 should be removed for this purpose.*

**Table I. Connections**

Connection	Signal Name
VIN+	Vin (+12V)
VIN-	Ground of Vin
Vout+	Vout(+1.2V)
Vout-	Ground for Vout
Vcc+	Vcc Pin
Vcc-	Ground for Vcc input
Enable	Enable
PGood	Power Good Signal
AGnd	Analog ground

**LAYOUT**

The PCB is a 6-layer board. All of layers are 2 Oz. copper. The IR3846 and most of the passive components are mounted on the top side of the board.

Power supply decoupling capacitors and feedback components are located close to IR3846. The feedback resistors are connected to the output of the remote sense amplifier of the IR3846 and are located close to the IR3846. To improve efficiency, the circuit board is designed to minimize the length of the on-board power ground current path. Separate power ground and analog ground are used and may be connected together using a 0 ohm resistor at R71.

**CONNECTIONS and OPERATING INSTRUCTIONS**

**LAYOUT**

The PCB is a 6-layer board. All of layers are 2 Oz. copper. The IR3846 and most of the passive components are mounted on the top side of the board.

Power supply decoupling capacitors and feedback components are located close to IR3846. The feedback resistors are connected to the output of the remote sense amplifier of the IR3846 and are located close to the IR3846. To improve efficiency, the circuit board is designed to minimize the length of the on-board power ground current path. Separate power ground and analog ground are used and may be connected together using a 0 ohm resistor at R71.

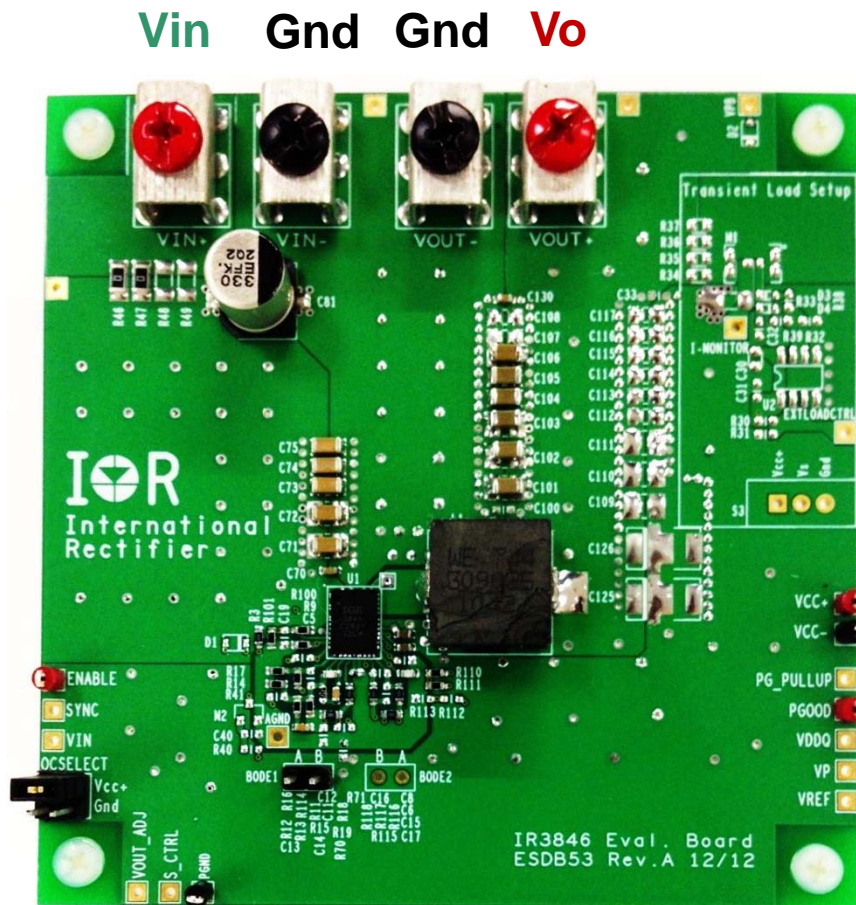

**Top View**

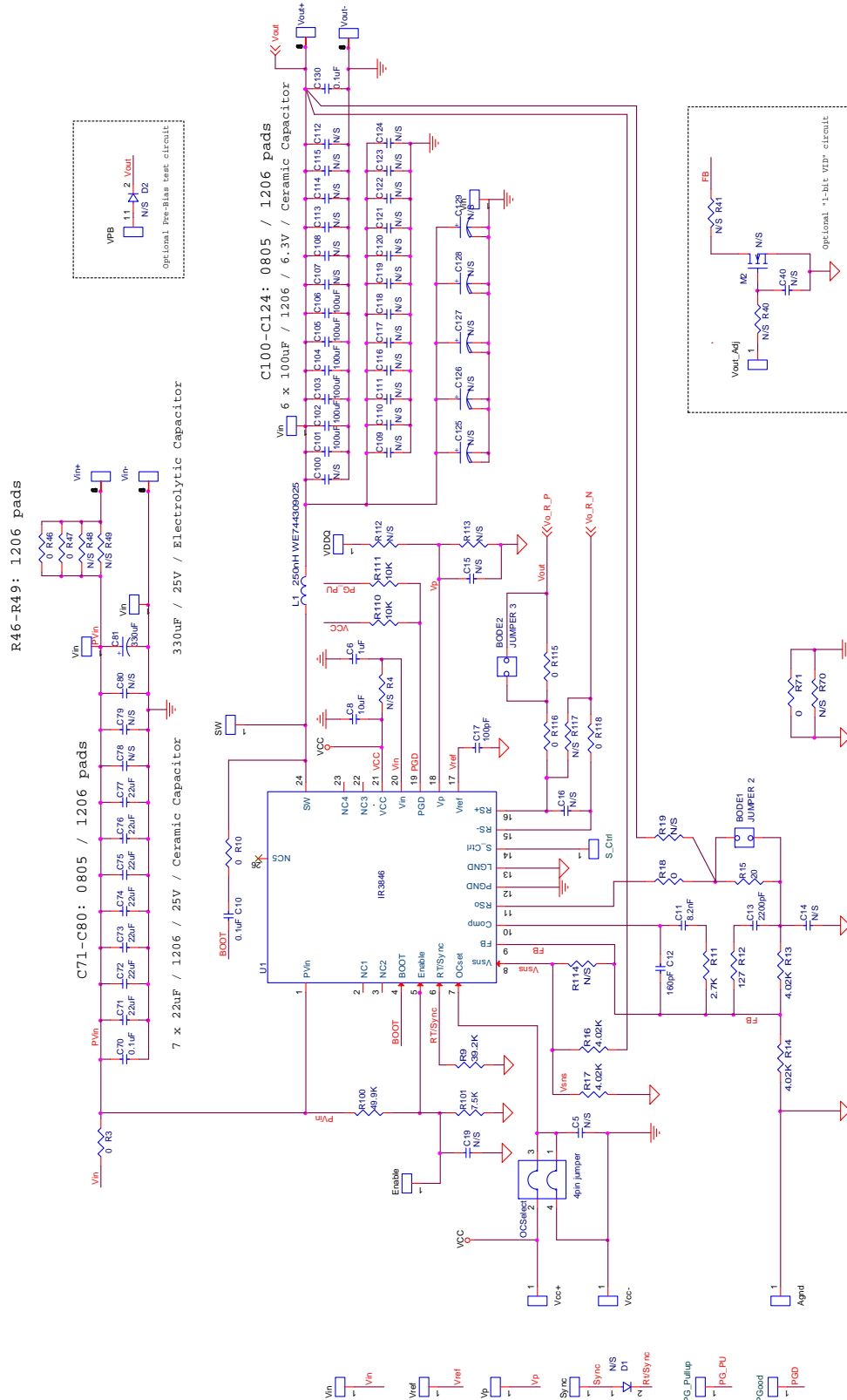

Single point of connection between Power  
Ground and Signal ("analog") Ground

Fig. 1: Schematic of the IRDC3846 evaluation board

**Schematic for Transient Load set up**

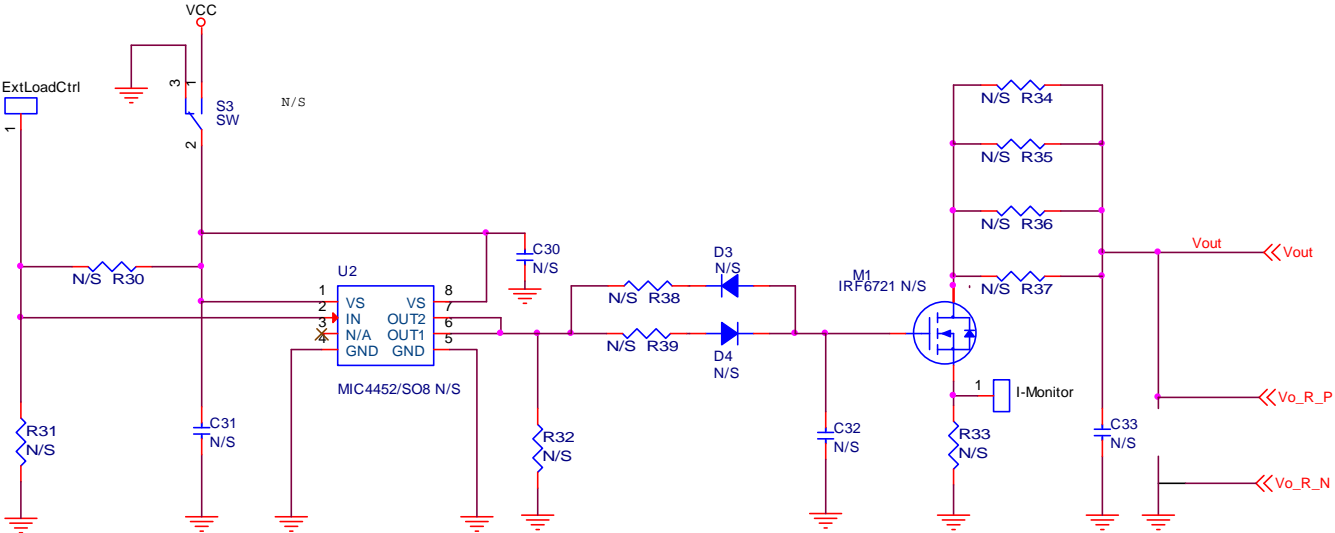

**Bill of Materials**

Item	Qty	Part Reference	Value	Description	Manufacturer	Part Number
1	7	C71 C72 C73 C74 C75 C76 C77	22uF	1206, 25V, X5R, 10%	Murata	GRM31CR61E226KE15L
2	1	C6	1uF	0603, X5R, 25V, 20%	TDK	C1608X5R1E105M
3	1	C8	10uF	0603, X5R, 10V, 20%	TDK	C1608X5R1A106M
4	3	C10 C70 C130	0.1uF	0603, 25V, X7R, 10%	Murata	GRM188R71E104KA01D
5	1	C11	8200pF	0603, 50V, X7R, 10%	Murata	GRM188R71H822KA01D
6	1	C12	160pF	0603, 50V, NPO, 5%	Murata	GRM1885C1H161JA01D
7	1	C13	2200pF	0603, 50V, X7R, 10%	Murata	GRM188R71H222KA01D
8	1	C17	100pF	0603, 50V, C0G, 5%	Murata	GRM1885C1H101JA01D
9	1	C81	330uF	SMD Electrolytic, Fsize, 25V, 20%	Panasonic	EEV-FK1E331P
10	1	L1	250nH	250nH, DCR=0.165mohm	Würth Electronics Inc.	744309025
11	6	C101 C102 C103 C104 C105 C106	100uF	1206, 6.3V, X5R, 20%	Murata	GRM31CR60J107ME39L
12	6	R3 R10 R18 R115 R116 R118	0	0603, 1/10W, Jumper	Vishay/Dale	CRCW06030000Z0EA
13	1	R9	39.2K	0603, 1/10W, 1%	Panasonic	ERJ-3EKF3922V
14	1	R11	2.7K	0603, 1/10W, 1%	Panasonic	ERJ-3EKF2701V
15	1	R12	127	0603, 1/10W, 1%	Panasonic	ERJ-3EKF1270V
16	4	R13 R14 R16 R17	4.02 K	0603, 1/10W, 1%	Panasonic	ERJ-3EKF4021V
17	1	R15	20	0603, 1/10W, 1%	Vishay/Dale	CRCW060320R0FKEA
18	2	R46 R47	0	1206, 1/4W, Jumper	Yageo	RC1206JR-070RL
19	1	R71	0	0402, 1/16W, Jumper	Yageo	RC0402JR-070RL
20	1	R100	49.9K	0603, 1/10 W, 1%	Panasonic	ERJ-3EKF4992V
21	1	R101	7.5K	0603, 1/10W, 1%	Panasonic	ERJ-3EKF7501V
22	2	R110 R111	10K	0603, 1/10 W, 1%	Panasonic	ERJ-3EKF1002V
23	1	Jumper		PLUG 40 POS DBL ROW STR	Omron Electronics Inc.	XG8W-4041-ND
24	2	Vin+ Vout+	RED	SCREW TERMINAL	Keystone Electronics	8199-2
25	2	Vin- Vout-	BLACK	SCREW TERMINAL	Keystone Electronics	8199-3
26	1	U1	IR3846	IR3846 5mm X 7mm	International Rectifier	IR3846MPBF

**TYPICAL OPERATING WAVEFORMS**

$V_{in}=12.0V$ ,  $V_o=1.2V$ ,  $I_o=0A-35A$ ,  $F_{sw}=600kHz$ , Room Temperature, No air flow

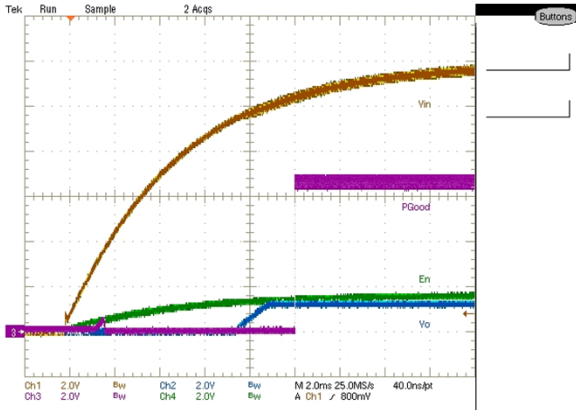

Fig. 2: Start up at 35A Load  
Ch<sub>1</sub>:V<sub>in</sub>, Ch<sub>2</sub>:V<sub>o</sub>, Ch<sub>3</sub>:PGood, Ch<sub>4</sub>:Enable

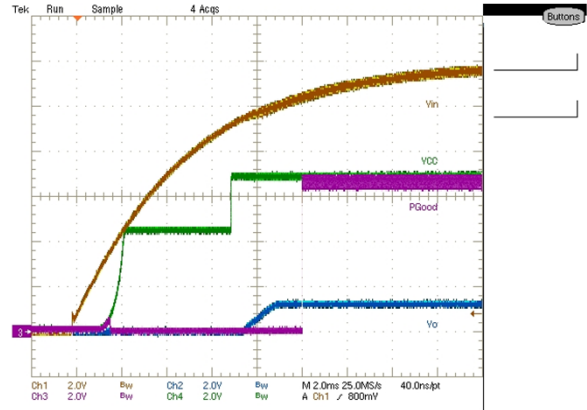

Fig. 3: Start up at 35A Load  
Ch<sub>1</sub>:V<sub>in</sub>, Ch<sub>2</sub>:V<sub>o</sub>, Ch<sub>3</sub>:PGood, Ch<sub>4</sub>:V<sub>cc</sub>

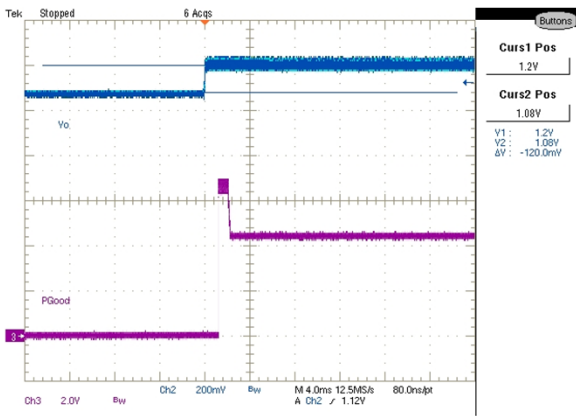

Fig. 4: Start up with 1.08V Pre Bias, 0A Load  
Ch<sub>2</sub>:V<sub>o</sub>, Ch<sub>3</sub>:PGood

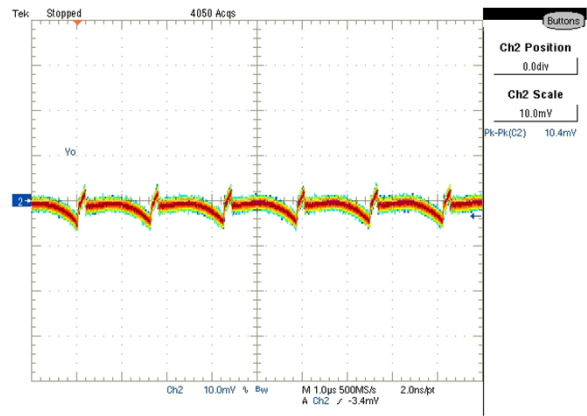

Fig. 5: Output Voltage Ripple, 35A load  
Ch<sub>1</sub>: V<sub>o</sub>

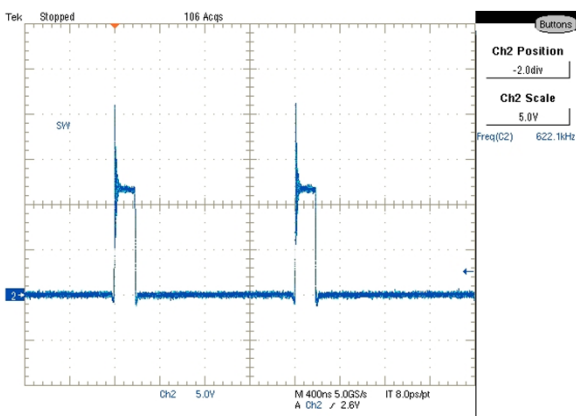

Fig. 6: Inductor node at 35A load  
Ch<sub>2</sub>:LX

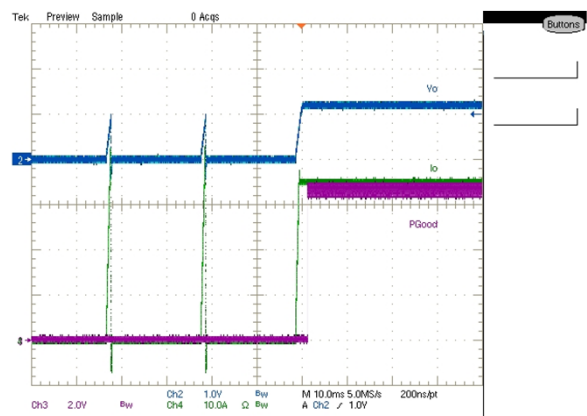

Fig. 7: Short (Hiccup) Recovery  
Ch<sub>2</sub>:V<sub>o</sub>, Ch<sub>3</sub>:PGood, Ch<sub>4</sub>:I<sub>o</sub>

**TYPICAL OPERATING WAVEFORMS**

Vin=12.0V, Vo=1.2V, Io=3.5A-14A, Fsw=600kHz, Room Temperature, No air flow

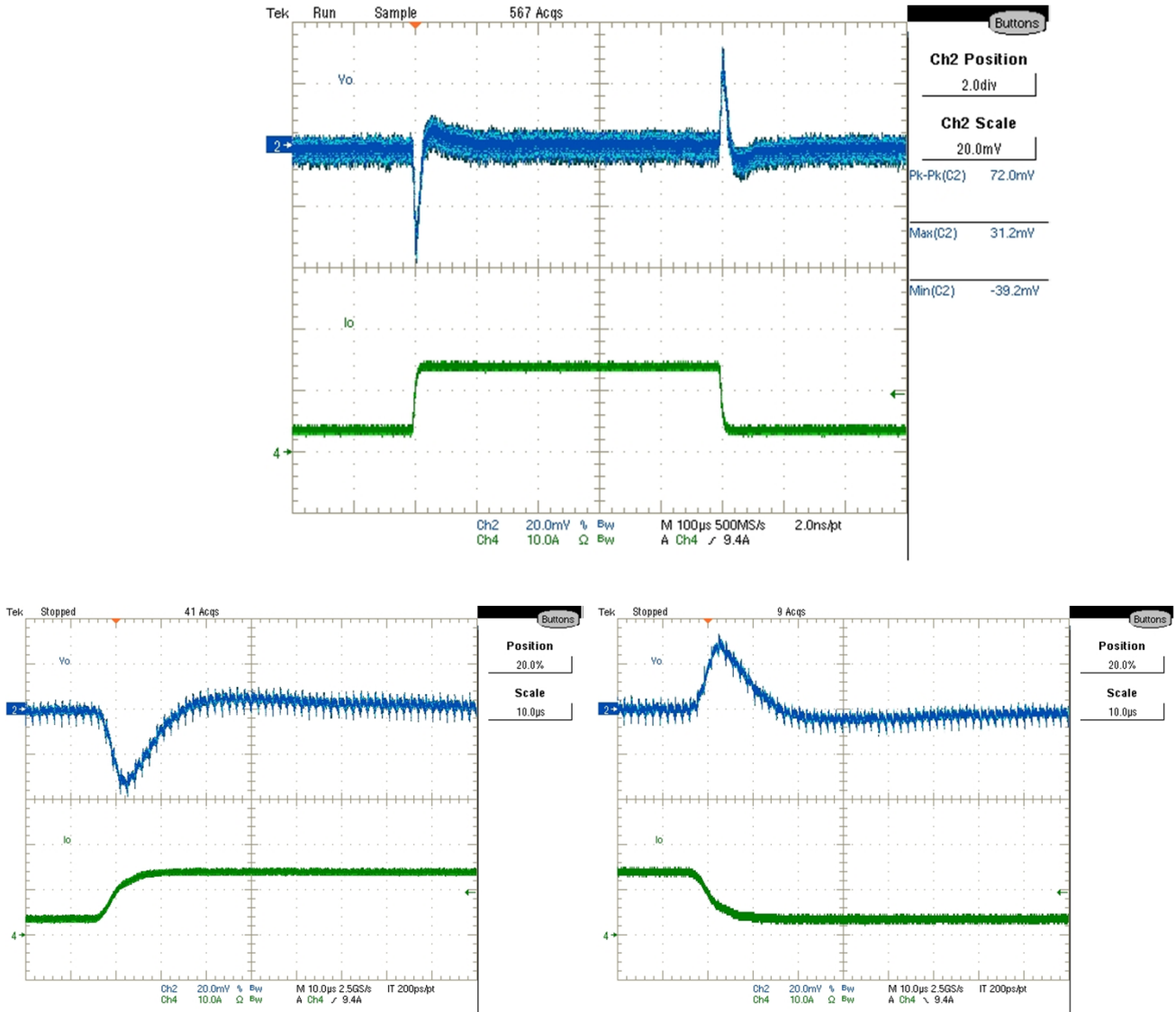

Fig. 8: Transient Response, 3.5A to 14A step (2.5A/us)  
 Ch<sub>2</sub>:V<sub>o</sub>



**TYPICAL OPERATING WAVEFORMS**

$V_{in}=12.0V$ ,  $V_o=1.2V$ ,  $I_o=24.5A-35.0A$ ,  $F_{sw}=600kHz$ , Room Temperature, No air flow

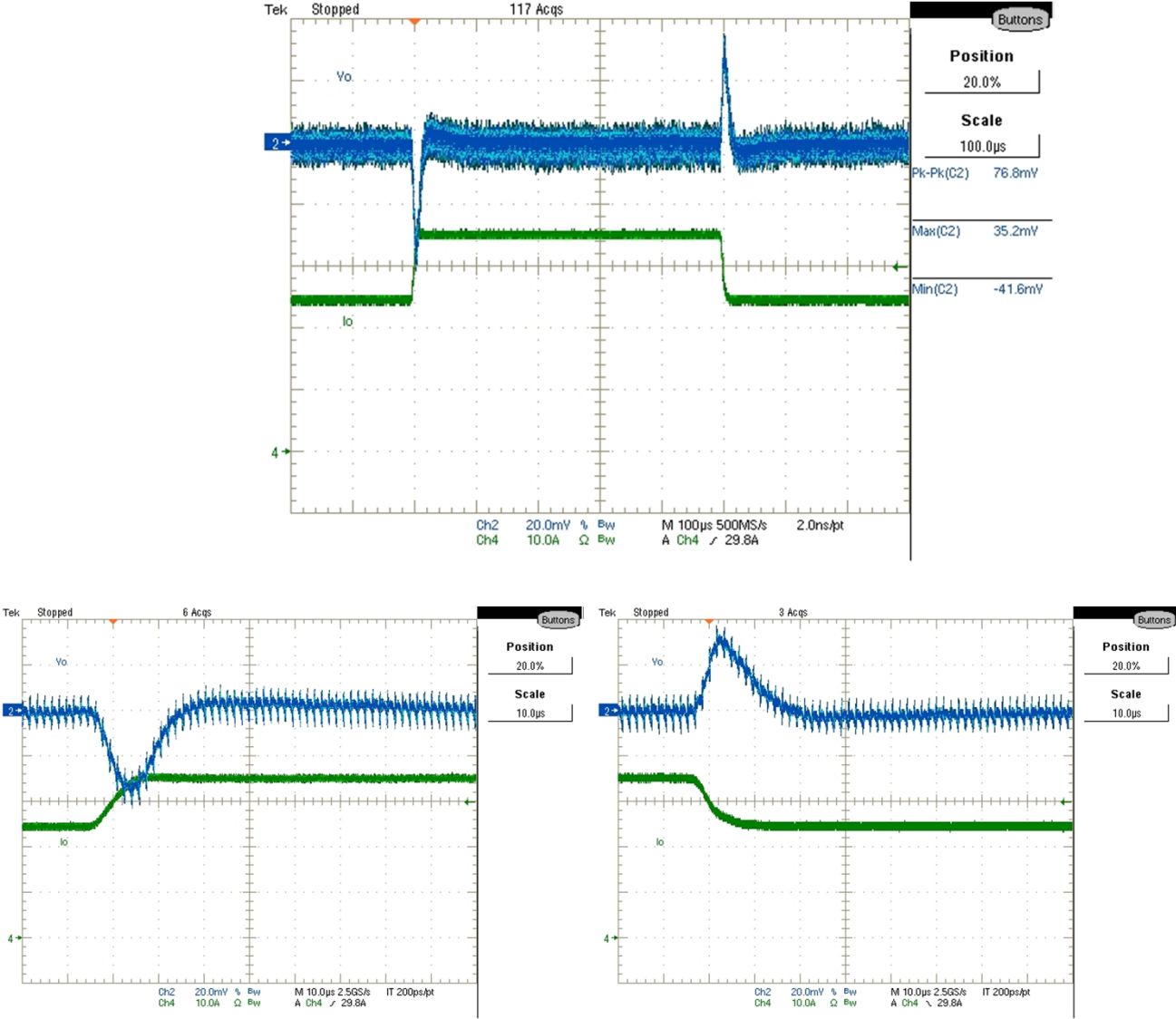
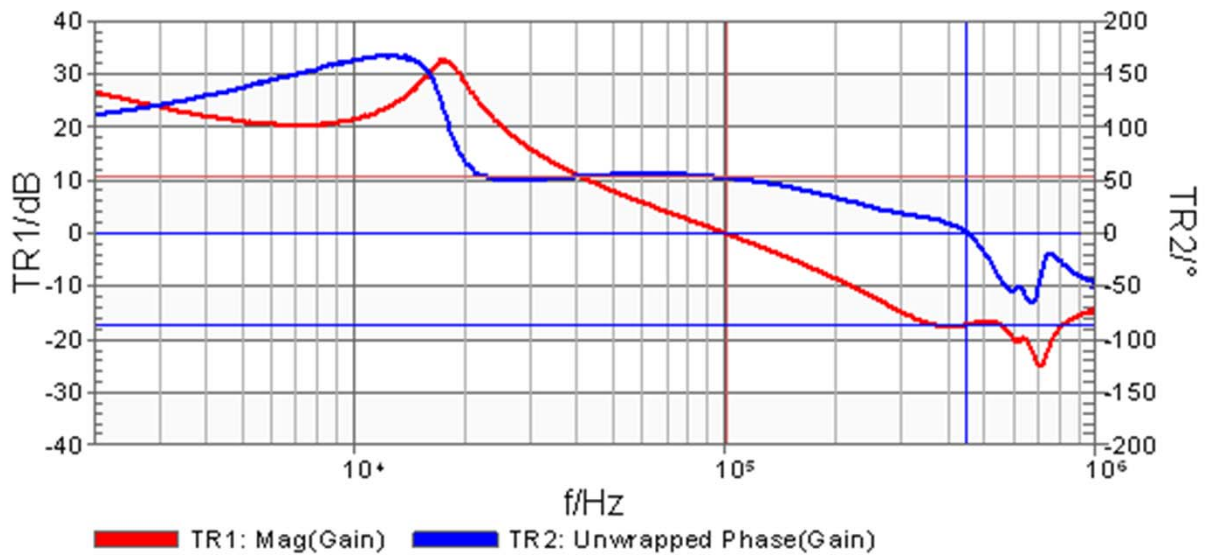

Fig. 9: Transient Response, 24.5A to 35A step (2.5A/µs)  
 Ch<sub>2</sub>:V<sub>o</sub>

**TYPICAL OPERATING WAVEFORMS**

Vin=12.0V, Vo=1.2V, Io=0A-35A, Fsw=600kHz, Room Temperature, No air flow



	Frequency	Trace1	Trace2
Cursor 1	100.624 kHz	0.000 dB	52.477 °
Cursor 2	451.686 kHz	-17.230 dB	0.000 °
Delta C2-C1	351.062 kHz	-17.230 dB	-52.477 °

Fig. 10: Bode Plot at 35A load: Fo = 100.6kHz; Phase Margin = 52.8°; Gain Margin = -17.2dB

**TYPICAL OPERATING WAVEFORMS**

$V_{in}=12.0V$ ,  $V_o=1.2V$ ,  $I_o=0A-35A$ ,  $F_{sw}=600kHz$ , Room Temperature, No air flow

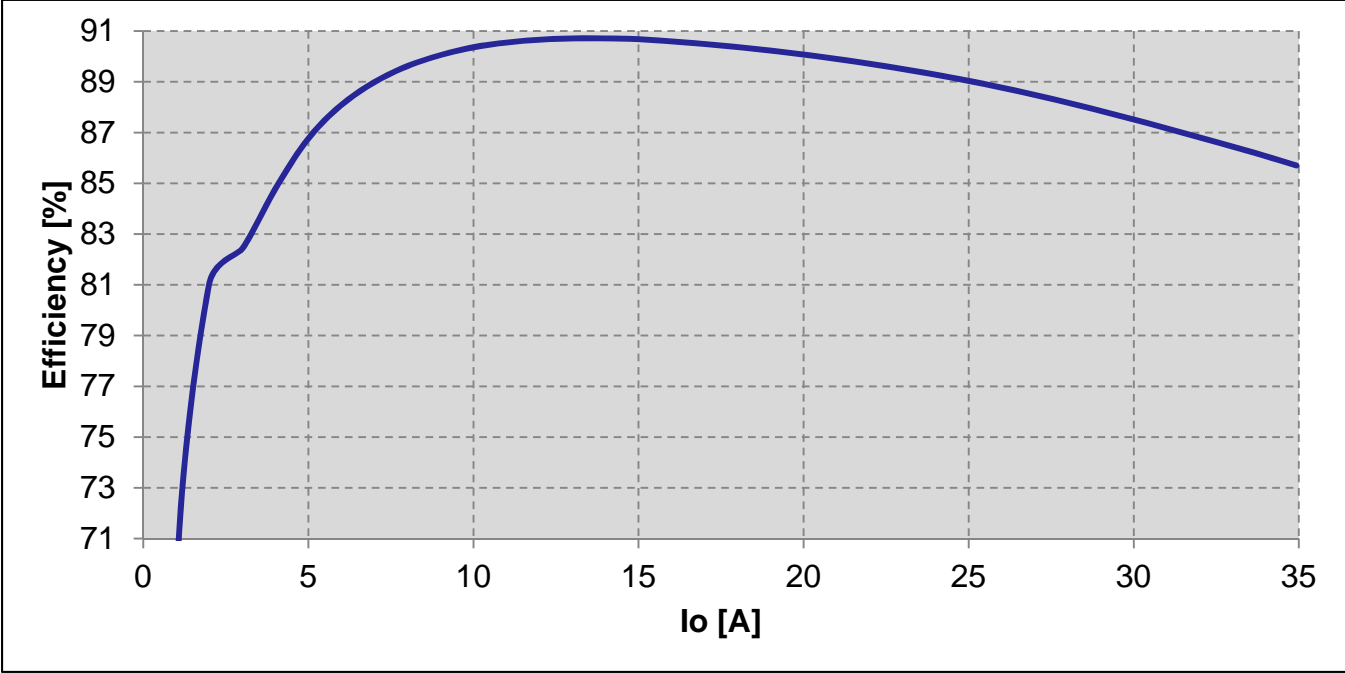

Fig.11: Efficiency versus load current

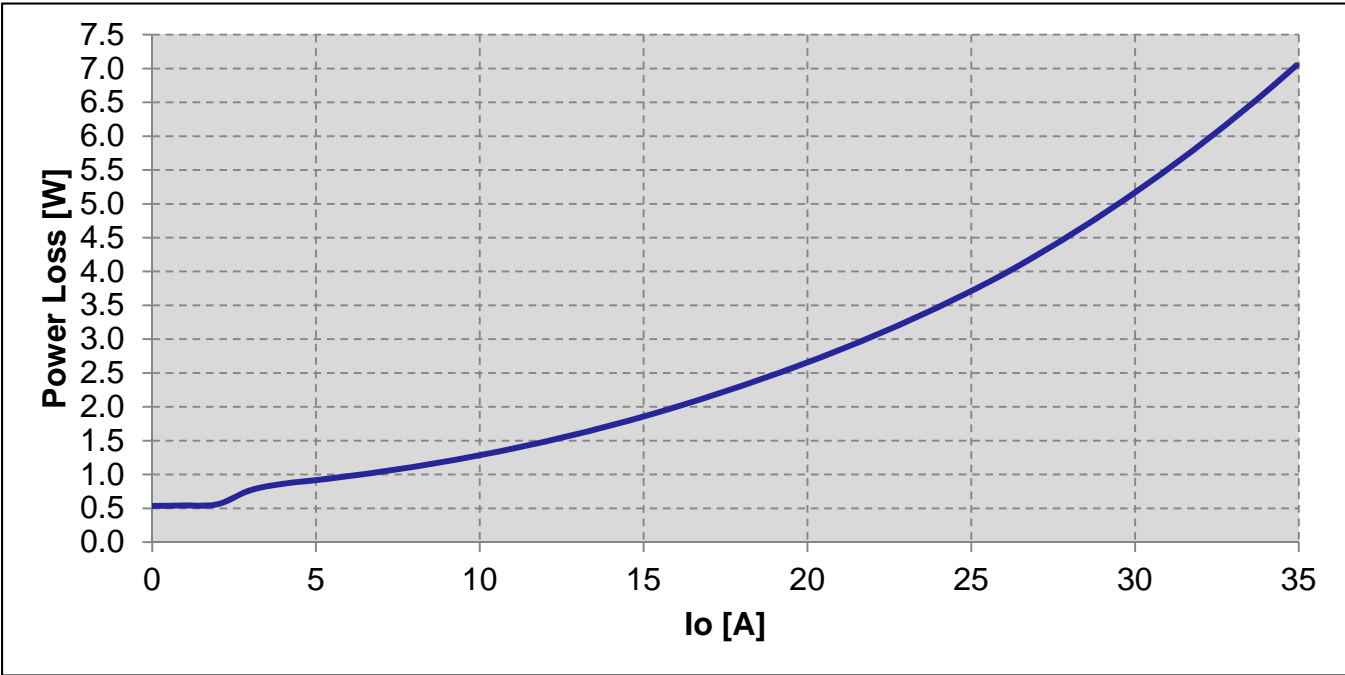

Fig.12: Power loss versus load current

**THERMAL IMAGES**

Vin=12.0V, Vo=1.2V, Io=35A, Fsw=600kHz, Room Temperature, No air flow

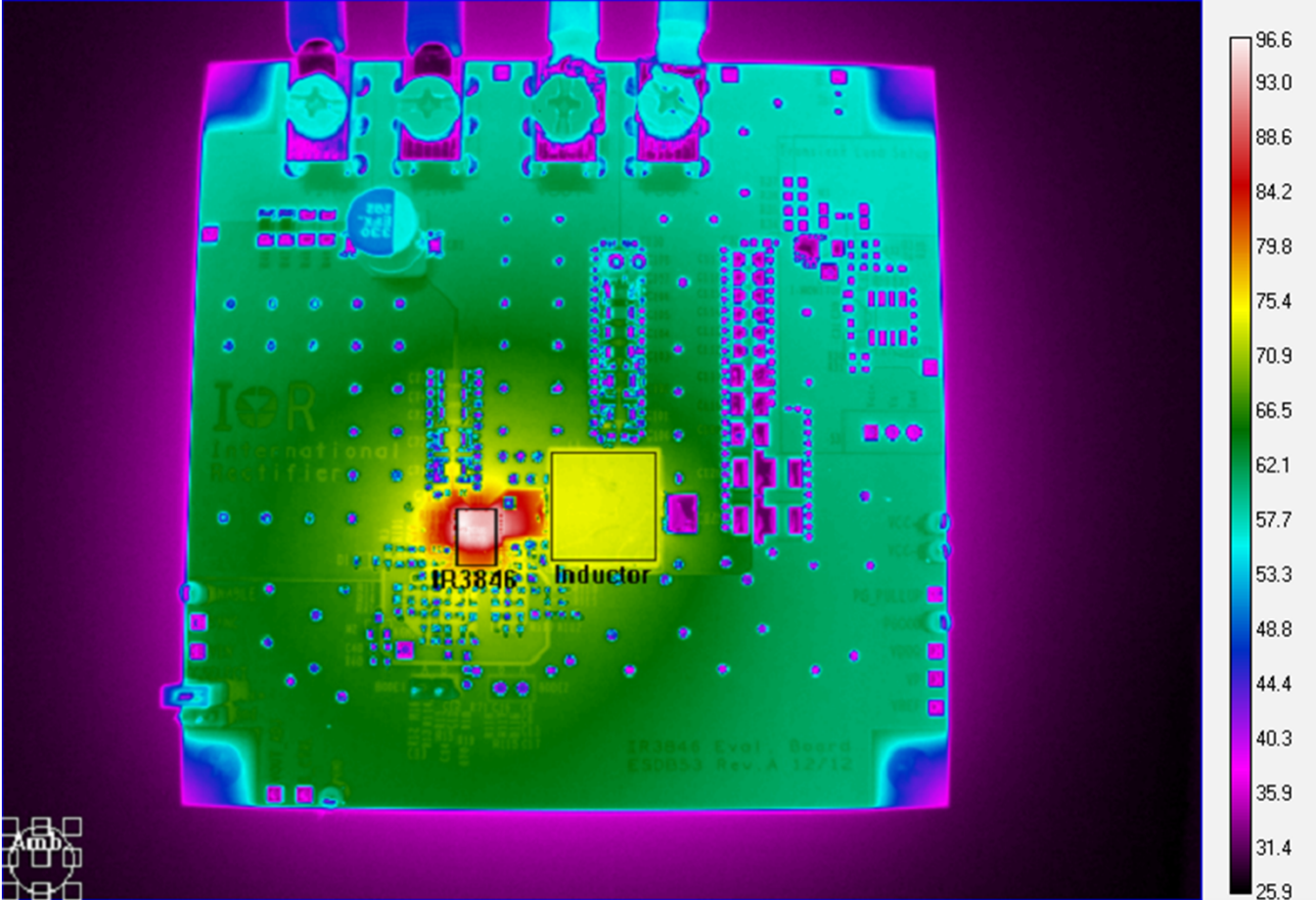

Fig. 13: Thermal Image of the board at 35A load  
Test point 1 is IR3846: 98.8°C  
Test point 2 is inductor: 72.9°C

**THERMAL IMAGES**

Vin=12.0V, Vo=1.2V, Io=35A, Fsw=600kHz, Room Temperature, LFM = 100

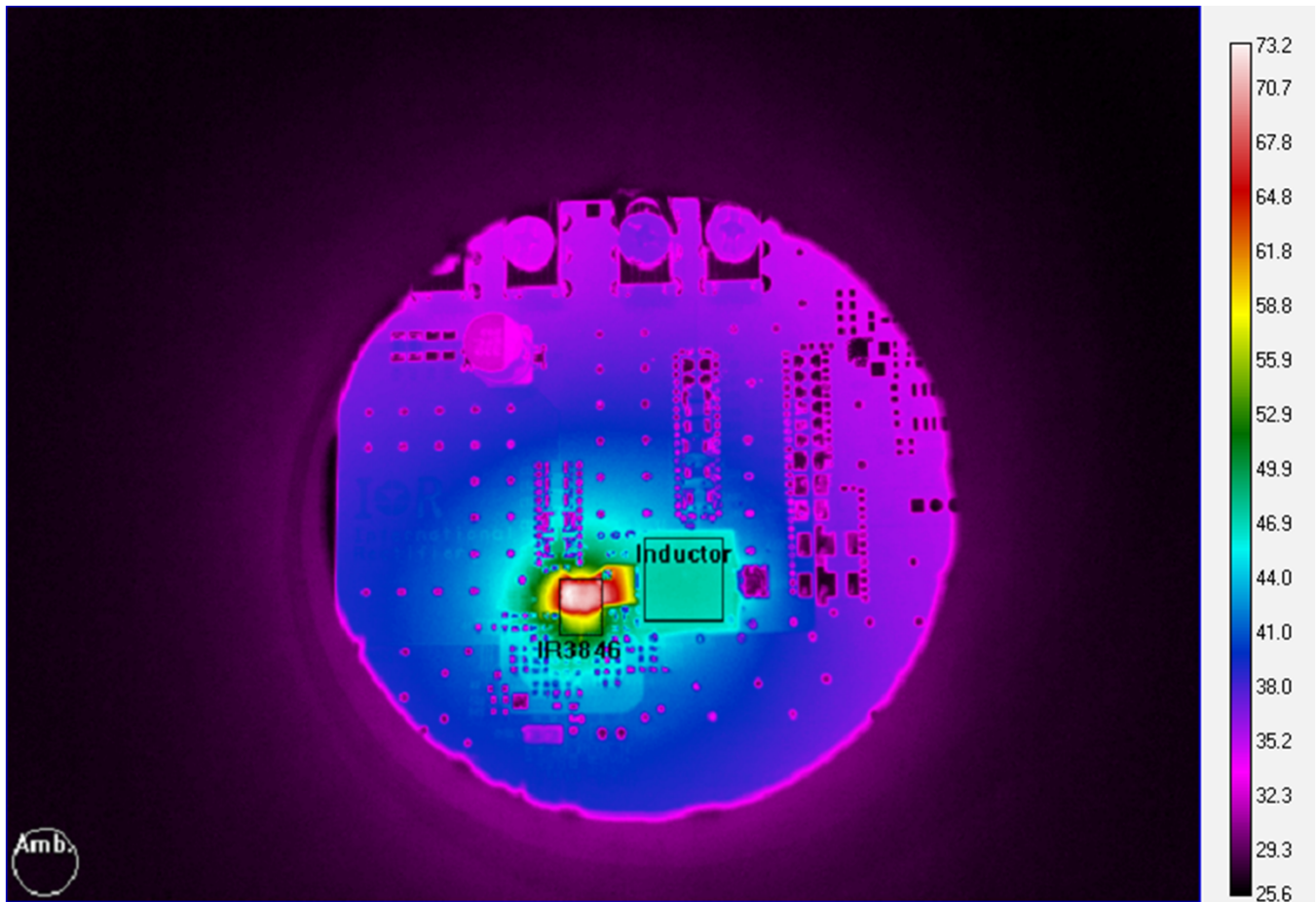

Fig. 14: Thermal Image of the board at 35A load  
Test point 1 is IR3846: 74°C  
Test point 2 is inductor: 46.9°C

International  
**IOR**Rectifier

**IR WORLD HEADQUARTERS:** 233 Kansas St., El Segundo, California 90245, USA Tel: (310) 252-7105  
TAC Fax: (310) 252-7903

Visit us at [www.irf.com](http://www.irf.com) for sales contact information  
*Data and specifications subject to change without notice.*

## X-ON Electronics

Largest Supplier of Electrical and Electronic Components

*Click to view similar products for [Power Management IC Development Tools](#) category:*

*Click to view products by [Infineon](#) manufacturer:*

Other Similar products are found below :

[EVB-EP5348UI](#) [MIC23451-AAAYFL EV](#) [MIC5281YMME EV](#) [124352-HMC860LP3E](#) [DA9063-EVAL](#) [ADP122-3.3-EVALZ](#) [ADP130-0.8-EVALZ](#) [ADP130-1.8-EVALZ](#) [ADP1740-1.5-EVALZ](#) [ADP1870-0.3-EVALZ](#) [ADP1874-0.3-EVALZ](#) [ADP199CB-EVALZ](#) [ADP2102-1.25-EVALZ](#) [ADP2102-1.875EVALZ](#) [ADP2102-1.8-EVALZ](#) [ADP2102-2-EVALZ](#) [ADP2102-3-EVALZ](#) [ADP2102-4-EVALZ](#) [AS3606-DB](#) [BQ25010EVM](#) [BQ3055EVM](#) [ISLUSBI2CKIT1Z](#) [LM2734YEVAL](#) [LP38512TS-1.8EV](#) [EVAL-ADM1186-1MBZ](#) [EVAL-ADM1186-2MBZ](#) [ADP122UJZ-REDYKIT](#) [ADP166Z-REDYKIT](#) [ADP170-1.8-EVALZ](#) [ADP171-EVALZ](#) [ADP1853-EVALZ](#) [ADP1873-0.3-EVALZ](#) [ADP198CP-EVALZ](#) [ADP2102-1.0-EVALZ](#) [ADP2102-1-EVALZ](#) [ADP2107-1.8-EVALZ](#) [ADP5020CP-EVALZ](#) [CC-ACC-DBMX-51](#) [ATPL230A-EK](#) [MIC23250-S4YMT EV](#) [MIC26603YJL EV](#) [MIC33050-SYHL EV](#) [TPS60100EVM-131](#) [TPS65010EVM-230](#) [TPS71933-28EVM-213](#) [TPS72728YFFEVM-407](#) [TPS79318YEQEV](#) [UCC28810EVM-002](#) [XILINXPWR-083](#) [LMR22007YMINI-EVM](#)