

- [RoHS Compliant, Halogen-Free](#) ②
- [Lead-Free \(Qualified up to 260°C Reflow\)](#) ①
- Application Specific MOSFETs
- Ideal for High Performance Isolated Converter Primary Switch Socket
- Optimized for Synchronous Rectification
- Low Conduction Losses
- High Cdv/dt Immunity
- Low Profile (<0.7mm)
- [Dual Sided Cooling Compatible](#) ①
- [Compatible with existing Surface Mount Techniques](#) ①

**DirectFET™ Power MOSFET** ②

Typical values (unless otherwise specified)

<b>V<sub>DSS</sub></b>	<b>V<sub>GS</sub></b>	<b>R<sub>DS(on)</sub></b>
100V max	±20V max	28mΩ @ 10V
<b>Q<sub>g tot</sub></b>	<b>Q<sub>gd</sub></b>	<b>V<sub>gs(th)</sub></b>
14nC	4.8nC	4.0V

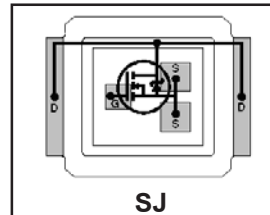

[Applicable DirectFET Outline and Substrate Outline \(see p.7,8 for details\)](#) ①

SH	<b>SJ</b>	SP		MZ	MN					
----	-----------	----	--	----	----	--	--	--	--	--

**Description**

The IRF6645PbF combines the latest HEXFET® Power MOSFET Silicon technology with the advanced DirectFET™ packaging to achieve the lowest on-state resistance in a package that has the footprint of an Micro8 and only 0.7 mm profile. The DirectFET package is compatible with existing layout geometries used in power applications, PCB assembly equipment and vapor phase, infra-red or convection soldering techniques, when application note [AN-1035](#) is followed regarding the manufacturing methods and processes. The DirectFET package allows dual sided cooling to maximize thermal transfer in power systems, improving previous best thermal resistance by 80%.

The IRF6645PbF is optimized for primary side bridge topologies in isolated DC-DC applications, for wide range universal input Telecom applications (36V - 75V), and for secondary side synchronous rectification in regulated DC-DC topologies. The reduced total losses in the device coupled with the high level of thermal performance enables high efficiency and low temperatures, which are key for system reliability improvements, and makes this device ideal for high performance isolated DC-DC converters.

**Absolute Maximum Ratings**

	Parameter	Max.	Units
V <sub>DS</sub>	Drain-to-Source Voltage	100	V
V <sub>GS</sub>	Gate-to-Source Voltage	±20	
I <sub>D</sub> @ T <sub>A</sub> = 25°C	Continuous Drain Current, V <sub>GS</sub> @ 10V ③	5.7	A
I <sub>D</sub> @ T <sub>A</sub> = 70°C	Continuous Drain Current, V <sub>GS</sub> @ 10V ③	4.5	
I <sub>D</sub> @ T <sub>C</sub> = 25°C	Continuous Drain Current, V <sub>GS</sub> @ 10V ④	25	
I <sub>DM</sub>	Pulsed Drain Current ⑤	45	
E <sub>AS</sub>	Single Pulse Avalanche Energy ⑥	29	mJ
I <sub>AR</sub>	Avalanche Current ⑤	3.4	A

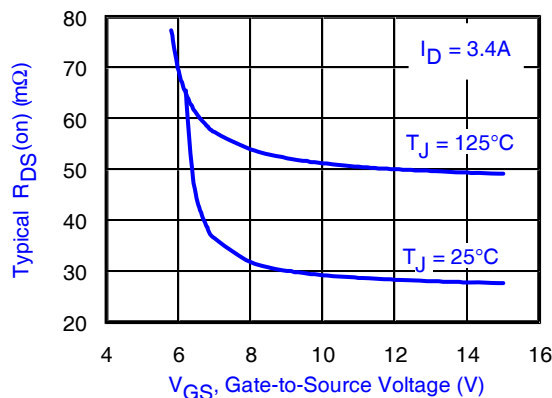

Fig 1. Typical On-Resistance vs. Gate Voltage

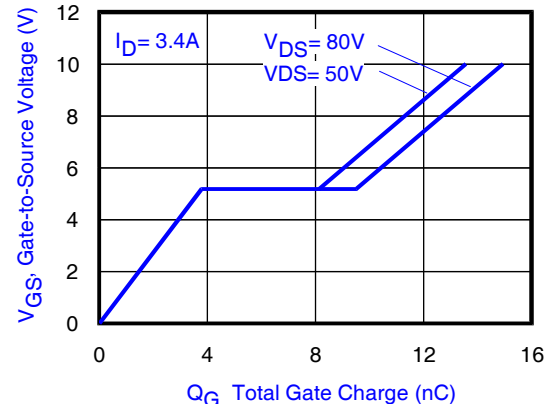

Fig 2. Typical Total Gate Charge vs. Gate-to-Source Voltage

Notes:

- ① Click on this section to link to the appropriate technical paper.
- ② Click on this section to link to the DirectFET Website.
- ③ Surface mounted on 1 in. square Cu board, steady state.
- ④ T<sub>C</sub> measured with thermocouple mounted to top (Drain) of part.
- ⑤ Repetitive rating; pulse width limited by max. junction temperature.
- ⑥ Starting T<sub>J</sub> = 25°C, L = 5.0mH, R<sub>G</sub> = 25Ω, I<sub>AS</sub> = 3.4A.

**Electrical Characteristic @  $T_J = 25^\circ\text{C}$  (unless otherwise specified)**

	Parameter	Min.	Typ.	Max.	Units	Conditions	
$BV_{DSS}$	Drain-to-Source Breakdown Voltage	100	—	—	V	$V_{GS} = 0V, I_D = 250\mu A$	
$\Delta BV_{DSS}/\Delta T_J$	Breakdown Voltage Temp. Coefficient	—	0.12	—	V/ $^\circ\text{C}$	Reference to $25^\circ\text{C}, I_D = 1\text{mA}$	
$R_{DS(on)}$	Static Drain-to-Source On-Resistance	—	28	35	m $\Omega$	$V_{GS} = 10V, I_D = 5.7A$ ⑦	
$V_{GS(th)}$	Gate Threshold Voltage	3.0	—	4.9	V	$V_{DS} = V_{GS}, I_D = 50\mu A$	
$\Delta V_{GS(th)}/\Delta T_J$	Gate Threshold Voltage Coefficient	—	-12	—	mV/ $^\circ\text{C}$		
$I_{DSS}$	Drain-to-Source Leakage Current	—	—	20	$\mu A$	$V_{DS} = 100V, V_{GS} = 0V$	
		—	—	250		$V_{DS} = 80V, V_{GS} = 0V, T_J = 125^\circ\text{C}$	
$I_{GSS}$	Gate-to-Source Forward Leakage	—	—	100	nA	$V_{GS} = 20V$	
	Gate-to-Source Reverse Leakage	—	—	-100		$V_{GS} = -20V$	
gfs	Forward Transconductance	7.4	—	—	S	$V_{DS} = 10V, I_D = 3.4A$	
$Q_g$	Total Gate Charge	—	14	20	nC	$V_{DS} = 50V$ $V_{GS} = 10V$ $I_D = 3.4A$ See Fig. 15	
$Q_{gs1}$	Pre-Vth Gate-to-Source Charge	—	3.1	—			
$Q_{gs2}$	Post-Vth Gate-to-Source Charge	—	0.8	—			
$Q_{gd}$	Gate-to-Drain Charge	—	4.8	7.2			
$Q_{godr}$	Gate Charge Overdrive	—	5.3	—			
$Q_{sw}$	Switch Charge ( $Q_{gs2} + Q_{gd}$ )	—	5.6	—			
$Q_{oss}$	Output Charge	—	7.2	—	nC	$V_{DS} = 16V, V_{GS} = 0V$	
$R_G$	Gate Resistance	—	1.0	—	$\Omega$		
$t_{d(on)}$	Turn-On Delay Time	—	9.2	—	ns	$V_{DD} = 50V, V_{GS} = 10V$ ⑦ $I_D = 3.4A$ $R_G = 6.2\Omega$	
$t_r$	Rise Time	—	5.0	—			
$t_{d(off)}$	Turn-Off Delay Time	—	18	—			
$t_f$	Fall Time	—	5.1	—			
$C_{iss}$	Input Capacitance	—	890	—	pF	$V_{GS} = 0V$ $V_{DS} = 25V$ $f = 1.0\text{MHz}$	
$C_{oss}$	Output Capacitance	—	180	—			
$C_{rss}$	Reverse Transfer Capacitance	—	40	—			
$C_{oss}$	Output Capacitance	—	870	—			$V_{GS} = 0V, V_{DS} = 1.0V, f = 1.0\text{MHz}$
$C_{oss}$	Output Capacitance	—	100	—			$V_{GS} = 0V, V_{DS} = 80V, f = 1.0\text{MHz}$

**Diode Characteristics**

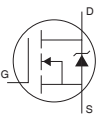
	Parameter	Min.	Typ.	Max.	Units	Conditions
$I_S$	Continuous Source Current (Body Diode)	—	—	25	A	MOSFET symbol showing the integral reverse p-n junction diode. 
$I_{SM}$	Pulsed Source Current (Body Diode) ⑤	—	—	45		
$V_{SD}$	Diode Forward Voltage	—	—	1.3	V	$T_J = 25^\circ\text{C}, I_S = 3.4A, V_{GS} = 0V$ ⑦
$t_{rr}$	Reverse Recovery Time	—	31	47	ns	$T_J = 25^\circ\text{C}, I_F = 3.4A, V_{DD} = 50V$
$Q_{rr}$	Reverse Recovery Charge	—	40	60	nC	$di/dt = 100A/\mu s$ ①

**Notes:**

- ⑤ Repetitive rating; pulse width limited by max. junction temperature.  
 ⑦ Pulse width  $\leq 400\mu s$ ; duty cycle  $\leq 2\%$ .

**Absolute Maximum Ratings**

	Parameter	Max.	Units
$P_D @ T_A = 25^\circ\text{C}$	Power Dissipation ③	2.2	W
$P_D @ T_A = 70^\circ\text{C}$	Power Dissipation ③	1.4	
$P_D @ T_C = 25^\circ\text{C}$	Power Dissipation ④	42	
$T_P$	Peak Soldering Temperature	270	°C
$T_J$	Operating Junction and	-40 to + 150	
$T_{STG}$	Storage Temperature Range		

**Thermal Resistance**

	Parameter	Typ.	Max.	Units
$R_{\theta JA}$	Junction-to-Ambient ③ ⑤	—	58	°C/W
$R_{\theta JA}$	Junction-to-Ambient ③ ⑥	12.5	—	
$R_{\theta JA}$	Junction-to-Ambient ③ ⑦	20	—	
$R_{\theta JC}$	Junction-to-Case ④ ⑧	—	3.0	
$R_{\theta J-PCB}$	Junction-to-PCB Mounted	1.0	—	

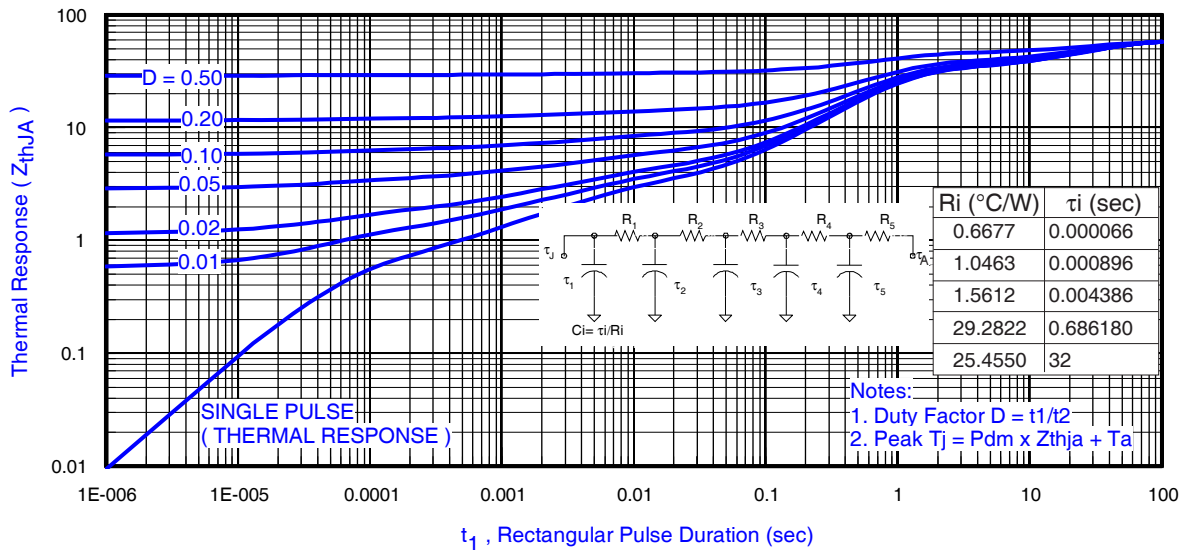

**Fig 3. Maximum Effective Transient Thermal Impedance, Junction-to-Ambient ①**

**Notes:**

- ③ Surface mounted on 1 in. square Cu board, steady state.
- ④  $T_C$  measured with thermocouple incontact with top (Drain) of part.
- ⑤ Mounted on minimum footprint full size board with metalized back and with small clip heatsink.
- ⑥ Used double sided cooling, mounting pad with large heatsink.
- ⑦  $R_{\theta}$  is measured at  $T_J$  of approximately  $90^\circ\text{C}$ .

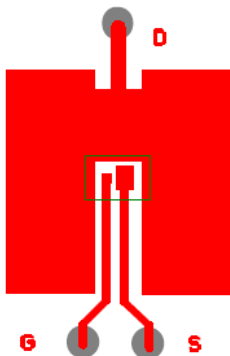

③ Surface mounted on 1 in. square Cu board (still air).

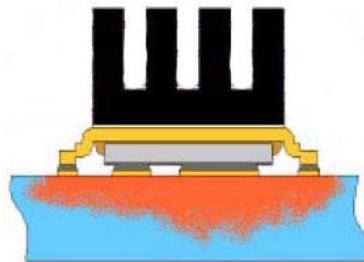

⑤ Mounted to a PCB with small clip heatsink (still air)

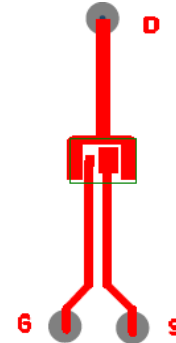

⑥ Mounted on minimum footprint full size board with metalized back and with small clip heatsink (still air)

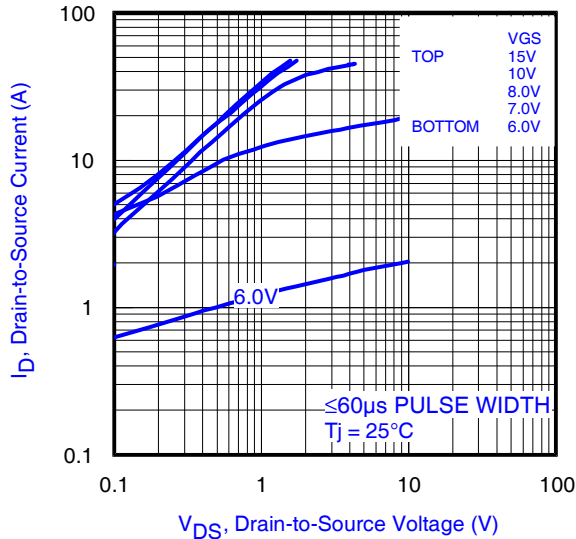

**Fig 4.** Typical Output Characteristics

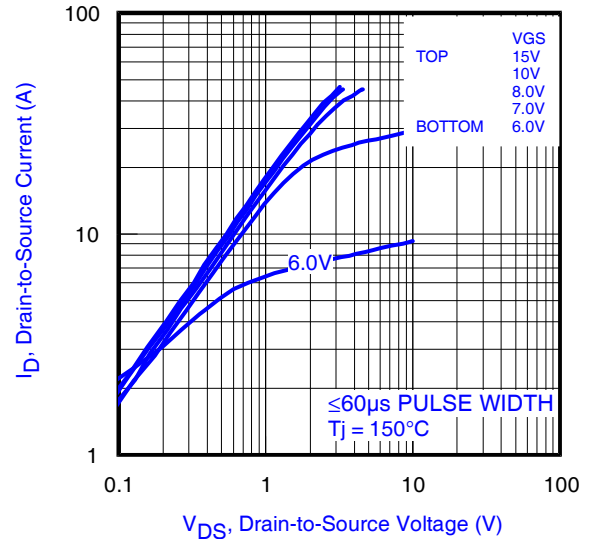

**Fig 5.** Typical Output Characteristics

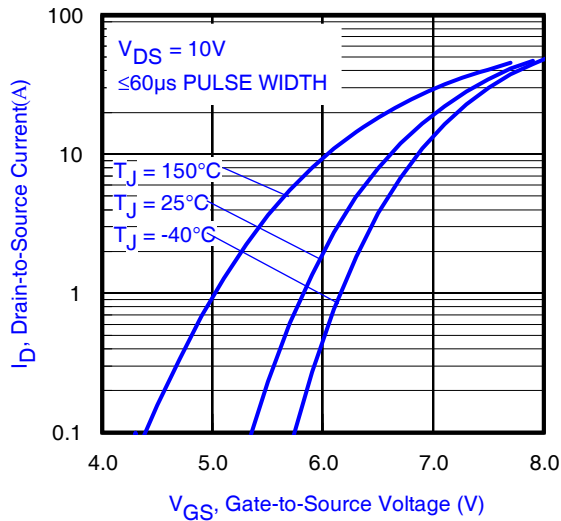

**Fig 6.** Typical Transfer Characteristics

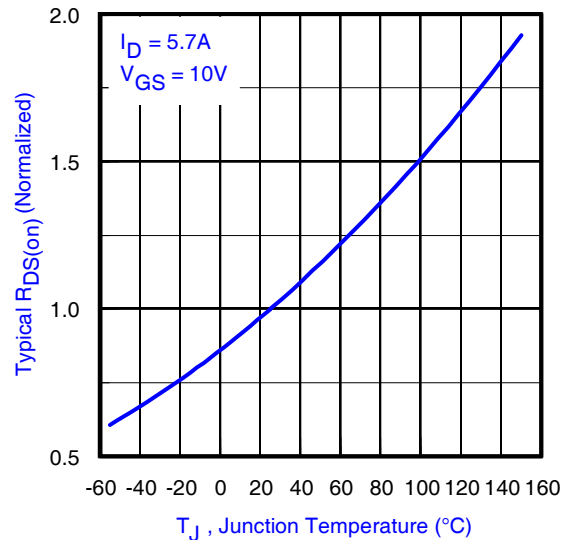

**Fig 7.** Normalized On-Resistance vs. Temperature

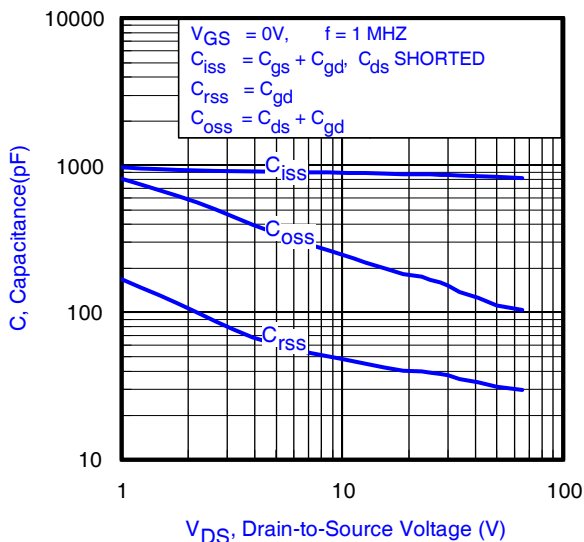

**Fig 8.** Typical Capacitance vs. Drain-to-Source Voltage

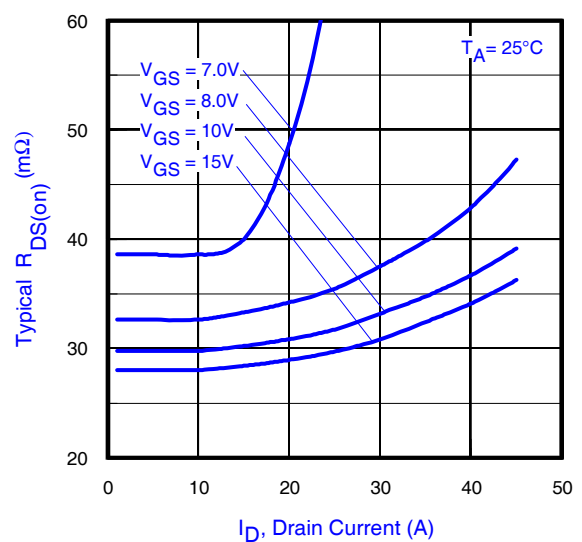

**Fig 9.** Typical On-Resistance vs. Drain Current

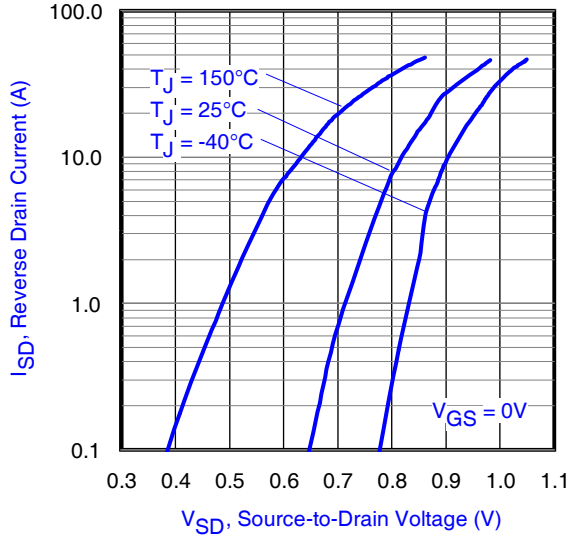

**Fig 10.** Typical Source-Drain Diode Forward Voltage

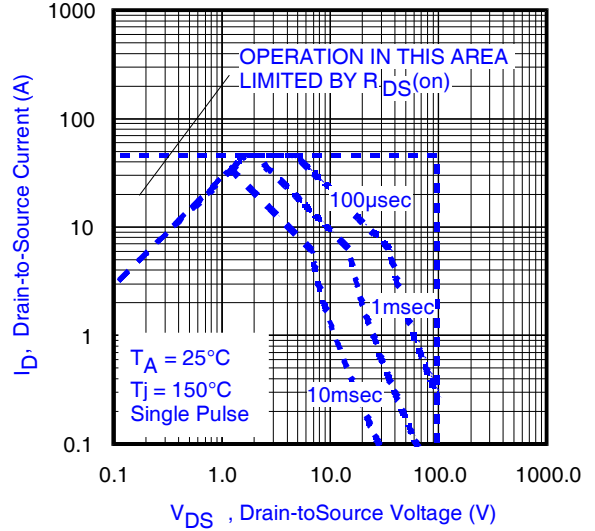

**Fig11.** Maximum Safe Operating Area

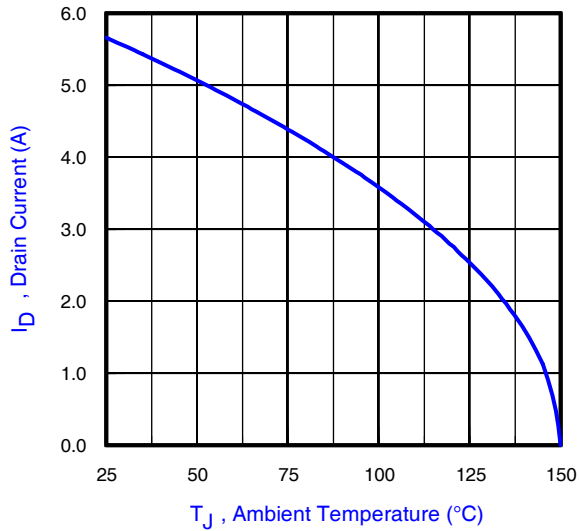

**Fig 12.** Maximum Drain Current vs. Ambient Temperature

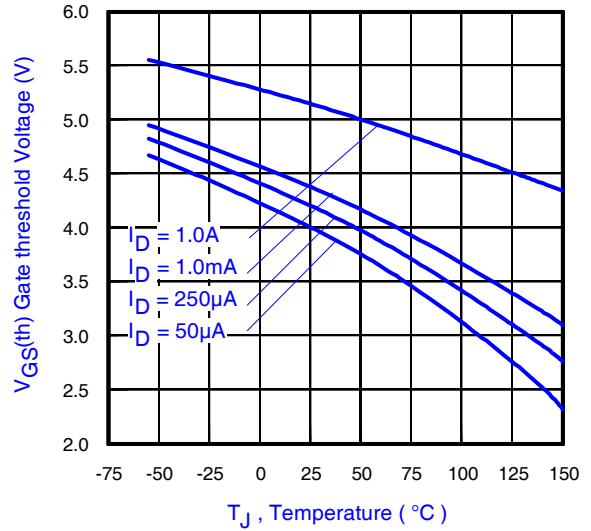

**Fig 13.** Typical Threshold Voltage vs. Junction Temperature

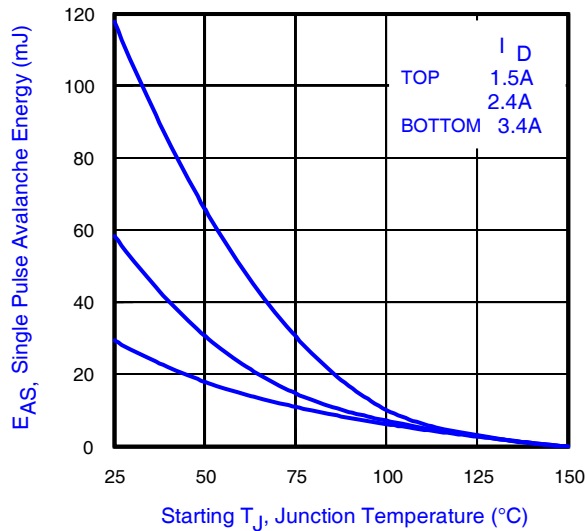

**Fig 14.** Maximum Avalanche Energy vs. Drain Current

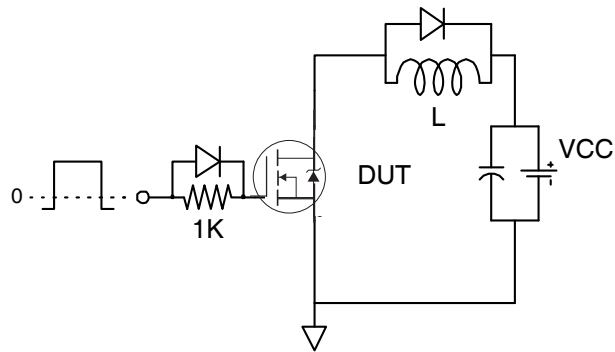

**Fig 15a.** Gate Charge Test Circuit

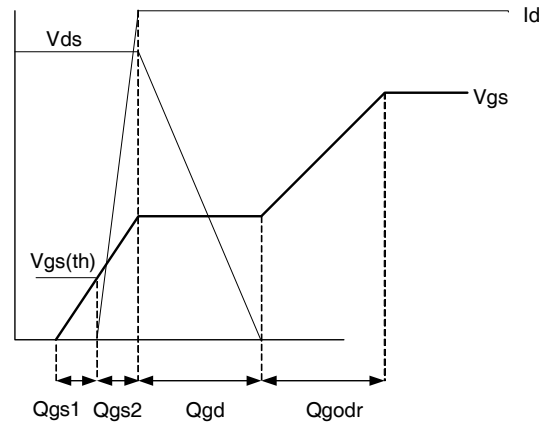

**Fig 15b.** Gate Charge Waveform

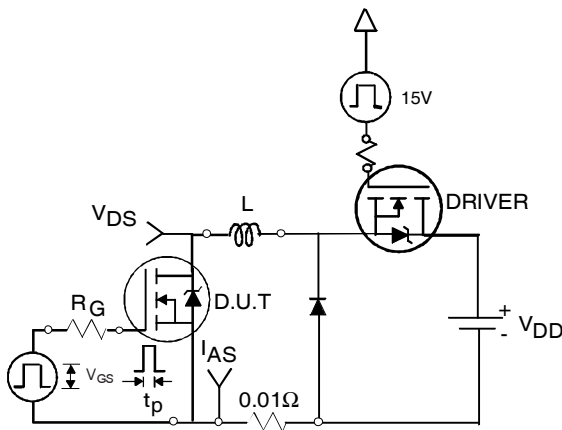

**Fig 16b.** Unclamped Inductive Test Circuit

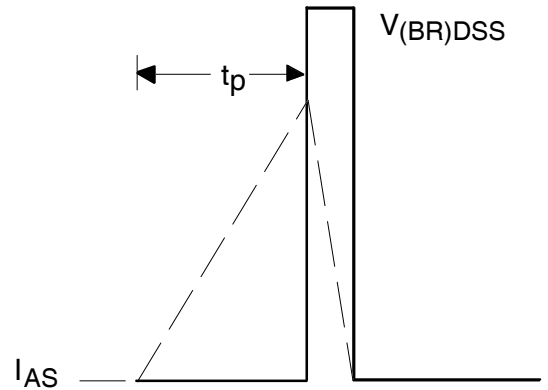

**Fig 16c.** Unclamped Inductive Waveforms

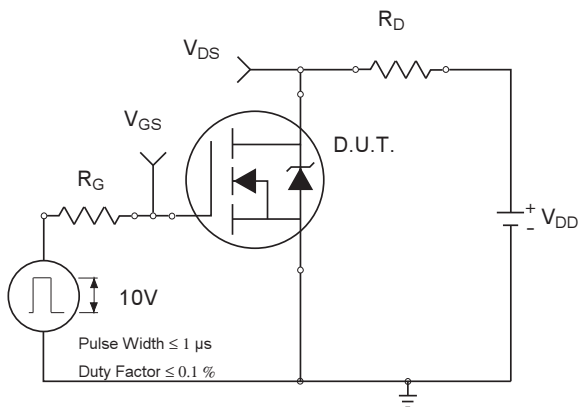

**Fig 17a.** Switching Time Test Circuit

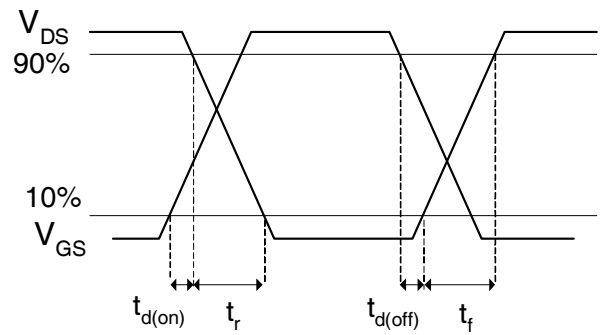

**Fig 17b.** Switching Time Waveforms

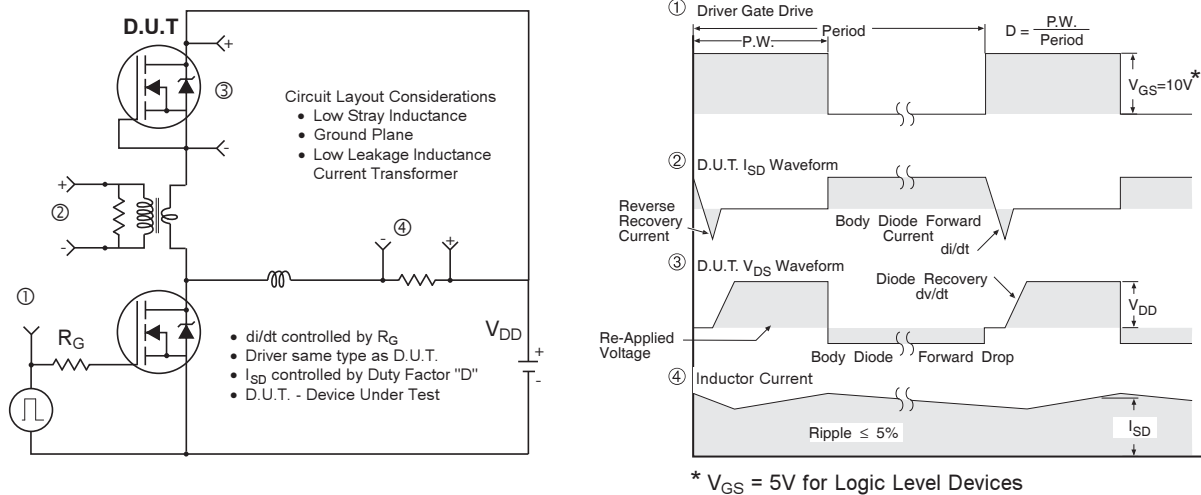

**Fig 18. Diode Reverse Recovery Test Circuit for N-Channel HEXFET® Power MOSFETs**

### DirectFET™ Substrate and PCB Layout, SJ Outline (Small Size Can, J-Designation).

Please see DirectFET application note [AN-1035](#) for all details regarding the assembly of DirectFET. This includes all recommendations for stencil and substrate designs.

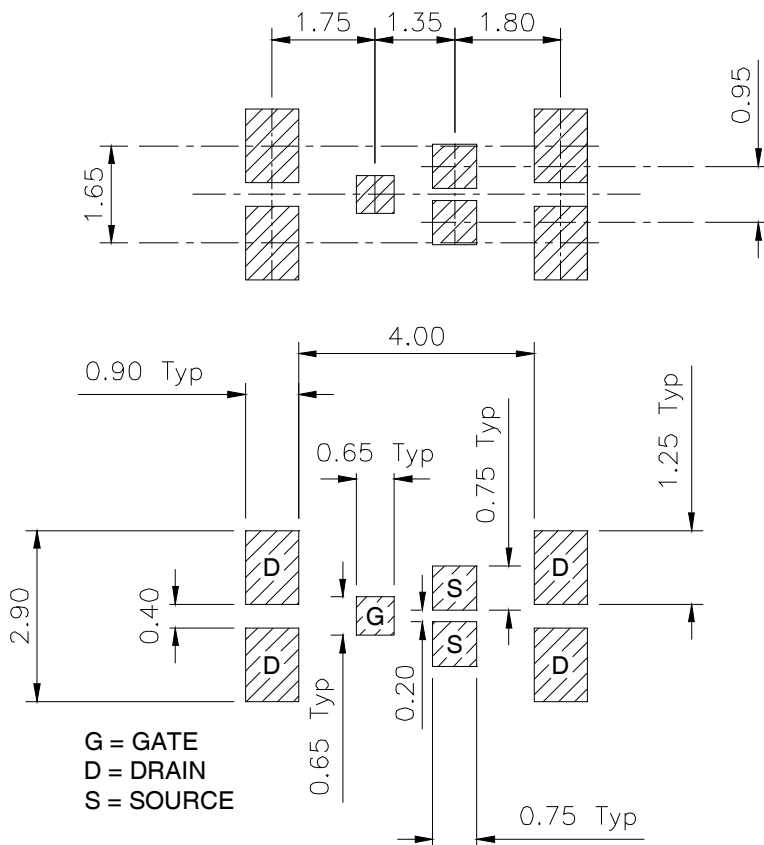

Note: For the most current drawing please refer to IR website at <http://www.irf.com/package>

**DirectFET™ Outline Dimension, SJ Outline  
(Small Size Can, J-Designation).**

Please see DirectFET application note [AN-1035](#) for all details regarding the assembly of DirectFET. This includes all recommendations for stencil and substrate designs.

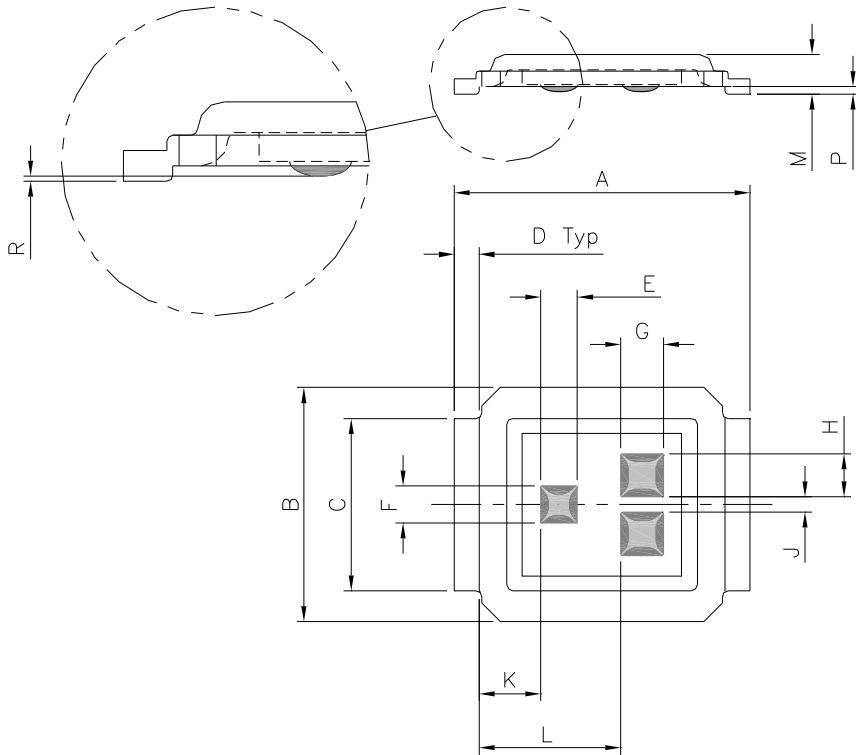

CODE	METRIC		IMPERIAL	
	MIN	MAX	MIN	MAX
A	4.75	4.85	0.187	0.191
B	3.70	3.95	0.146	0.156
C	2.75	2.85	0.108	0.112
D	0.35	0.45	0.014	0.018
E	0.58	0.62	0.023	0.024
F	0.58	0.62	0.023	0.024
G	0.68	0.72	0.027	0.028
H	0.68	0.72	0.027	0.028
J	0.23	0.27	0.009	0.010
K	0.95	1.05	0.037	0.041
L	2.25	2.35	0.089	0.093
M	0.59	0.70	0.023	0.028
P	0.08	0.17	0.003	0.007
R	0.020	0.080	0.0008	0.0031

**DirectFET™ Part Marking**

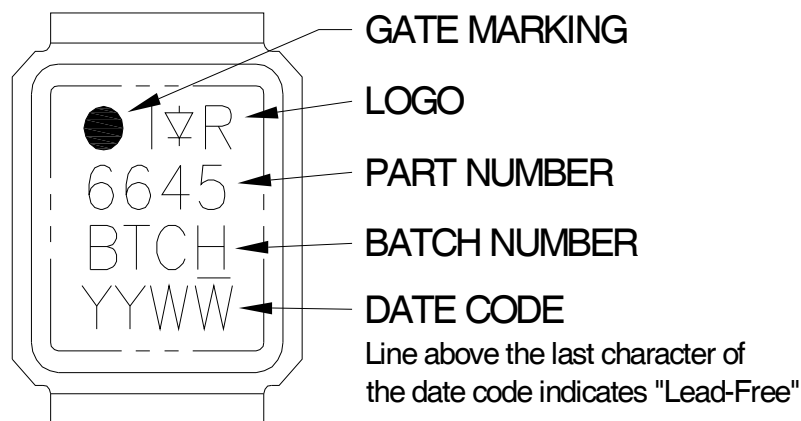

Note: For the most current drawing please refer to IR website at <http://www.irf.com/package>



DirectFET™ Tape & Reel Dimension (Showing component orientation).

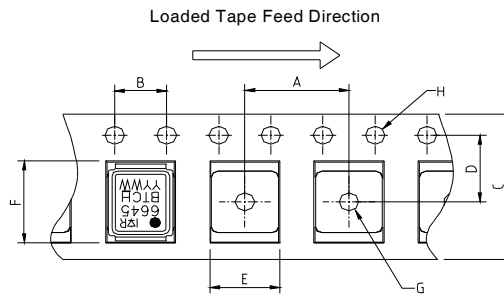
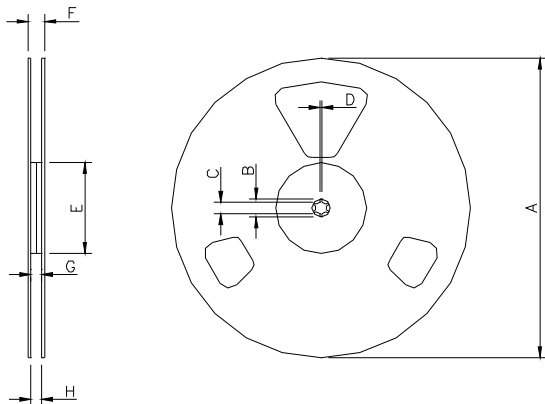

NOTE: Controlling dimensions in mm  
 Std reel quantity is 4800 parts. (ordered as IRF6645TRPBF). For 1000 parts on 7" reel, order IRF6645TR1PBF

CODE	METRIC		IMPERIAL	
	MIN	MAX	MIN	MAX
A	7.90	8.10	0.311	0.319
B	3.90	4.10	0.154	0.161
C	11.90	12.30	0.469	0.484
D	5.45	5.55	0.215	0.219
E	4.00	4.20	0.158	0.165
F	5.00	5.20	0.197	0.205
G	1.50	N.C	0.059	N.C
H	1.50	1.60	0.059	0.063

REEL DIMENSIONS								
CODE	STANDARD OPTION (QTY 4800)				TR1 OPTION (QTY 1000)			
	METRIC		IMPERIAL		METRIC		IMPERIAL	
	MIN	MAX	MIN	MAX	MIN	MAX	MIN	MAX
A	330.0	N.C	12.992	N.C	177.77	N.C	6.9	N.C
B	20.2	N.C	0.795	N.C	19.06	N.C	0.75	N.C
C	12.8	13.2	0.504	0.520	13.5	12.8	0.53	0.50
D	1.5	N.C	0.059	N.C	1.5	N.C	0.059	N.C
E	100.0	N.C	3.937	N.C	58.72	N.C	2.31	N.C
F	N.C	18.4	N.C	0.724	N.C	13.50	N.C	0.53
G	12.4	14.4	0.488	0.567	11.9	12.01	0.47	N.C
H	11.9	15.4	0.469	0.606	11.9	12.01	0.47	N.C

Note: For the most current drawing please refer to IR website at <http://www.irf.com/package>

**Revision History**

Date	Comments
12/10/2012	Updated package outline, on page 8.
2/26/2013	Updated P <sub>D</sub> @ T <sub>A</sub> = 25C from 3W to 2.2W, on page 3.

This product has been designed and qualified for the Consumer market.  
 Qualification Standards can be found on IR's Web site.  
 Data and specifications subject to change without notice.

## **IMPORTANT NOTICE**

The information given in this document shall in no event be regarded as a guarantee of conditions or characteristics ("Beschaffenhheitsgarantie").

With respect to any examples, hints or any typical values stated herein and/or any information regarding the application of the product, Infineon Technologies hereby disclaims any and all warranties and liabilities of any kind, including without limitation warranties of non-infringement of intellectual property rights of any third party.

In addition, any information given in this document is subject to customer's compliance with its obligations stated in this document and any applicable legal requirements, norms and standards concerning customer's products and any use of the product of Infineon Technologies in customer's applications.

The data contained in this document is exclusively intended for technically trained staff. It is the responsibility of customer's technical departments to evaluate the suitability of the product for the intended application and the completeness of the product information given in this document with respect to such application.

For further information on the product, technology, delivery terms and conditions and prices please contact your nearest Infineon Technologies office ([www.infineon.com](http://www.infineon.com)).

## **WARNINGS**

Due to technical requirements products may contain dangerous substances. For information on the types in question please contact your nearest Infineon Technologies office.

Except as otherwise explicitly approved by Infineon Technologies in a written document signed by authorized representatives of Infineon Technologies, Infineon Technologies' products may not be used in any applications where a failure of the product or any consequences of the use thereof can reasonably be expected to result in personal injury.

## X-ON Electronics

Largest Supplier of Electrical and Electronic Components

*Click to view similar products for [MOSFET](#) category:*

*Click to view products by [Infineon](#) manufacturer:*

Other Similar products are found below :

[614233C](#) [648584F](#) [IRFD120](#) [JANTX2N5237](#) [FCA20N60\\_F109](#) [FDZ595PZ](#) [2SK2545\(Q,T\)](#) [405094E](#) [423220D](#) [TPCC8103,L1Q\(CM](#)  
[MIC4420CM-TR](#) [VN1206L](#) [614234A](#) [715780A](#) [NTNS3166NZT5G](#) [SSM6J414TU,LF\(T](#) [751625C](#) [BUK954R8-60E](#) [GROUP A 5962-](#)  
[8877003PA](#) [NTE6400](#) [SQJ402EP-T1-GE3](#) [2SK2614\(TE16L1,Q\)](#) [2N7002KW-FAI](#) [DMN1017UCP3-7](#) [EFC2J004NUZTDG](#) [ECH8691-TL-W](#)  
[FCAB21350L1](#) [P85W28HP2F-7071](#) [DMN1053UCP4-7](#) [NTE221](#) [NTE222](#) [NTE2384](#) [NTE2903](#) [NTE2941](#) [NTE2945](#) [NTE2946](#) [NTE2960](#)  
[NTE2967](#) [NTE2969](#) [NTE2976](#) [NTE6400A](#) [NTE2910](#) [NTE2916](#) [NTE2956](#) [NTE2911](#) [DMN2080UCB4-7](#) [TK10A80W,S4X\(S](#)  
[SSM6P69NU,LF](#) [DMP22D4UFO-7B](#) [DMN1006UCA6-7](#)