

IRF7240PbF

HEXFET® Power MOSFET

- Ultra Low On-Resistance
- P-Channel MOSFET
- Surface Mount
- Available in Tape & Reel
- Lead-Free

V_{DSS}	$R_{DS(on)}$ max	I_D
-40V	0.015@ $V_{GS} = -10V$	-10.5A
	0.025@ $V_{GS} = -4.5V$	-8.4A

Description

These P-Channel MOSFETs from International Rectifier utilize advanced processing techniques to achieve the extremely low on-resistance per silicon area. This benefit provides the designer with an extremely efficient device for use in battery and load management applications..

The SO-8 has been modified through a customized leadframe for enhanced thermal characteristics and multiple-die capability making it ideal in a variety of power applications. With these improvements, multiple devices can be used in an application with dramatically reduced board space. The package is designed for vapor phase, infrared, or wave soldering techniques.

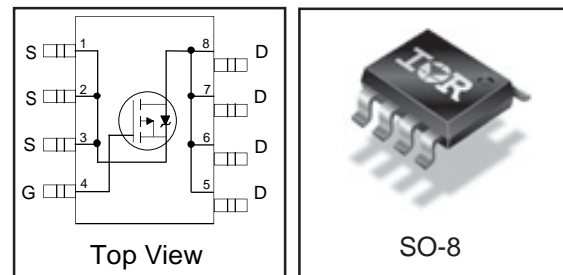

Absolute Maximum Ratings

	Parameter	Max.	Units
V_{DS}	Drain- Source Voltage	-40	V
$I_D @ T_A = 25^\circ C$	Continuous Drain Current, $V_{GS} @ -10V$	-10.5	A
$I_D @ T_A = 70^\circ C$	Continuous Drain Current, $V_{GS} @ -10V$	-8.6	
I_{DM}	Pulsed Drain Current ①	-43	
$P_D @ T_A = 25^\circ C$	Power Dissipation ③	2.5	W
$P_D @ T_A = 70^\circ C$	Power Dissipation③	1.6	
	Linear Derating Factor	20	mW/°C
V_{GS}	Gate-to-Source Voltage	± 20	V
T_J, T_{STG}	Junction and Storage Temperature Range	-55 to + 150	°C

Thermal Resistance

	Parameter	Max.	Units
$R_{\theta JA}$	Maximum Junction-to-Ambient③	50	°C/W

IRF7240PbF

International
IR Rectifier

Electrical Characteristics @ $T_J = 25^\circ\text{C}$ (unless otherwise specified)

	Parameter	Min.	Typ.	Max.	Units	Conditions
$V_{(BR)DSS}$	Drain-to-Source Breakdown Voltage	-40	—	—	V	$V_{GS} = 0V, I_D = -250\mu A$
$\Delta V_{(BR)DSS}/\Delta T_J$	Breakdown Voltage Temp. Coefficient	—	-0.025	—	V/ $^\circ\text{C}$	Reference to 25°C , $I_D = -1\text{mA}$
$R_{DS(on)}$	Static Drain-to-Source On-Resistance	—	—	0.015	Ω	$V_{GS} = -10V, I_D = -10.5A$ ②
		—	—	0.025		$V_{GS} = -4.5V, I_D = -8.4A$ ②
$V_{GS(th)}$	Gate Threshold Voltage	-1.0	—	-3.0	V	$V_{DS} = V_{GS}, I_D = -250\mu A$
g_{fs}	Forward Transconductance	17	—	—	S	$V_{DS} = -10V, I_D = -10.5A$
I_{DSS}	Drain-to-Source Leakage Current	—	—	-15	μA	$V_{DS} = -32V, V_{GS} = 0V$
		—	—	-25		$V_{DS} = -32V, V_{GS} = 0V, T_J = 70^\circ\text{C}$
I_{GSS}	Gate-to-Source Forward Leakage	—	—	-100	nA	$V_{GS} = -20V$
	Gate-to-Source Reverse Leakage	—	—	100		$V_{GS} = 20V$
Q_g	Total Gate Charge	—	73	110	nC	$I_D = -10.5A$
Q_{gs}	Gate-to-Source Charge	—	31	47		$V_{DS} = -20V$
Q_{gd}	Gate-to-Drain ("Miller") Charge	—	17	26		$V_{GS} = -10V$
$t_{d(on)}$	Turn-On Delay Time	—	52	—	ns	$V_{DD} = -20V$ ②
t_r	Rise Time	—	490	—		$I_D = -1.0A$
$t_{d(off)}$	Turn-Off Delay Time	—	210	—		$R_G = 6.0\Omega$
t_f	Fall Time	—	97	—		$V_{GS} = -10V$
C_{iss}	Input Capacitance	—	9250	—	pF	$V_{GS} = 0V$
C_{oss}	Output Capacitance	—	580	—		$V_{DS} = -25V$
C_{rss}	Reverse Transfer Capacitance	—	520	—		$f = 1.0\text{kHz}$

Source-Drain Ratings and Characteristics

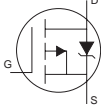
	Parameter	Min.	Typ.	Max.	Units	Conditions
I_S	Continuous Source Current (Body Diode)	—	—	-2.5	A	MOSFET symbol showing the integral reverse p-n junction diode. 
I_{SM}	Pulsed Source Current (Body Diode) ①	—	—	-43		
V_{SD}	Diode Forward Voltage	—	—	-1.2	V	$T_J = 25^\circ\text{C}, I_S = -2.5A, V_{GS} = 0V$ ②
t_{rr}	Reverse Recovery Time	—	43	65	ns	$T_J = 25^\circ\text{C}, I_F = -2.5A$
Q_{rr}	Reverse Recovery Charge	—	75	110	nC	$di/dt = -100A/\mu s$ ②

Notes:

- ① Repetitive rating; pulse width limited by max. junction temperature.
- ② Pulse width $\leq 400\mu s$; duty cycle $\leq 2\%$.
- ③ Surface mounted on 1 in square Cu board, $t \leq 5\text{sec}$.

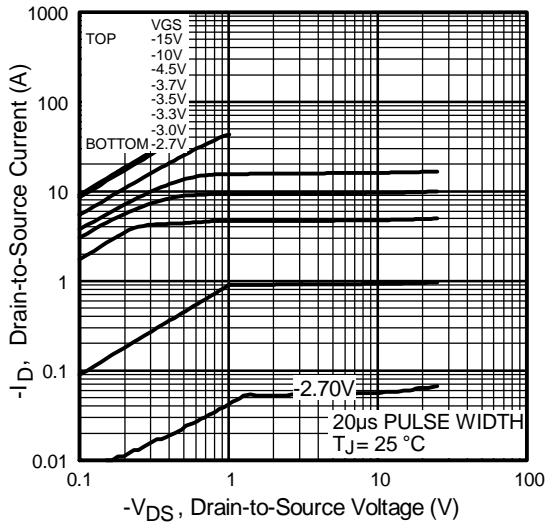

Fig 1. Typical Output Characteristics

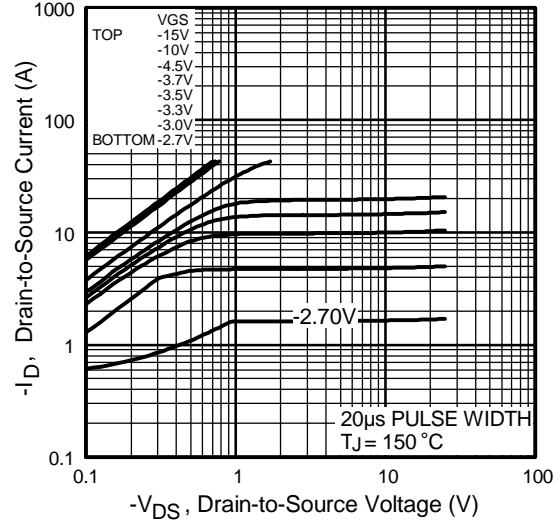

Fig 2. Typical Output Characteristics

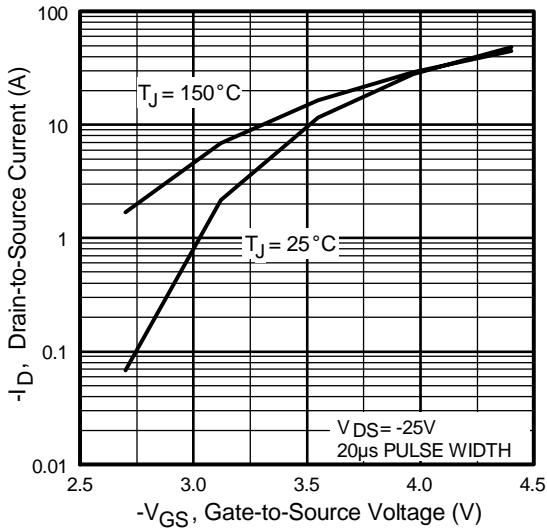

Fig 3. Typical Transfer Characteristics

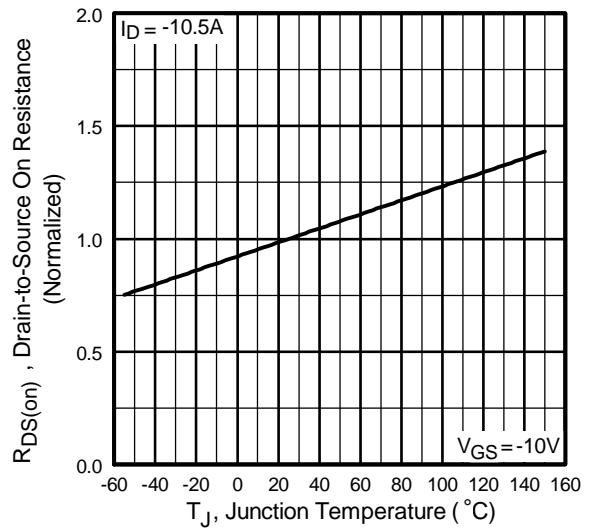

Fig 4. Normalized On-Resistance Vs. Temperature

IRF7240PbF

International
IR Rectifier

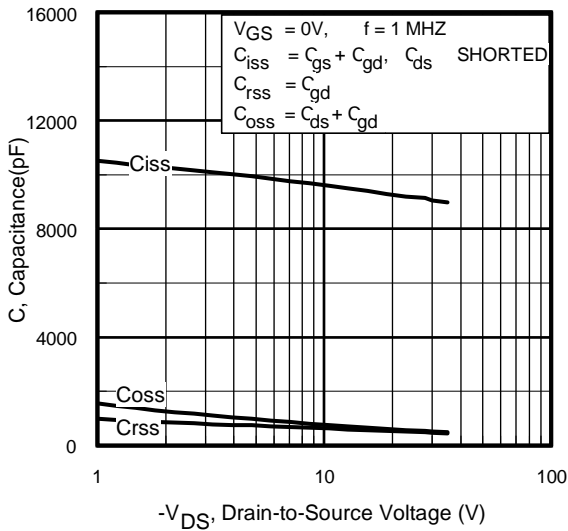

Fig 5. Typical Capacitance Vs. Drain-to-Source Voltage

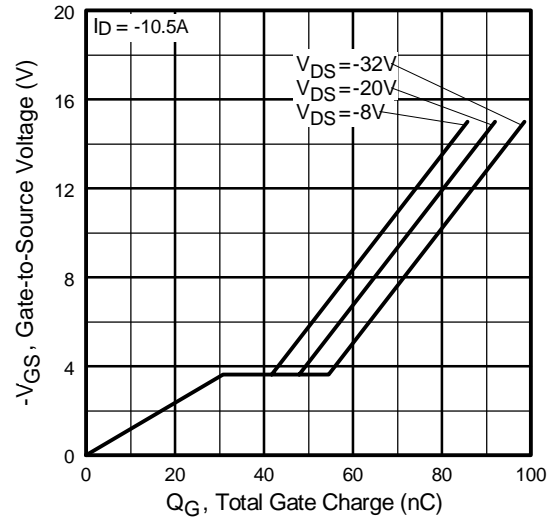

Fig 6. Typical Gate Charge Vs. Gate-to-Source Voltage

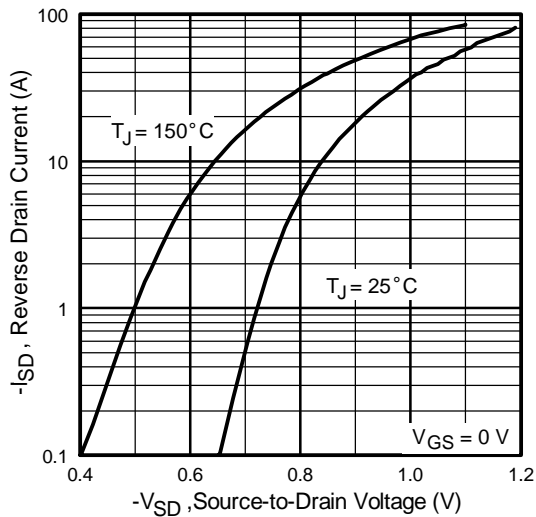

Fig 7. Typical Source-Drain Diode Forward Voltage

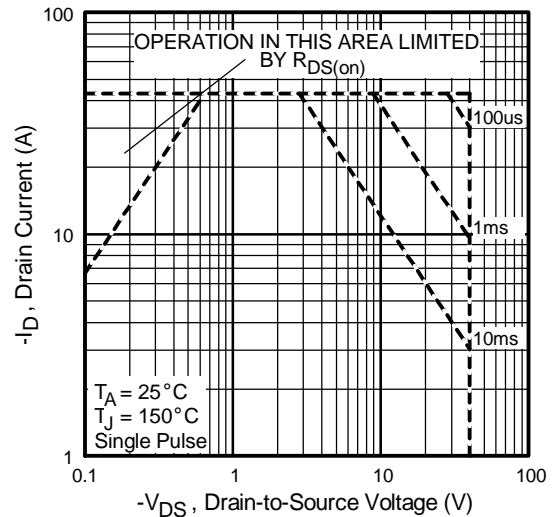

Fig 8. Maximum Safe Operating Area

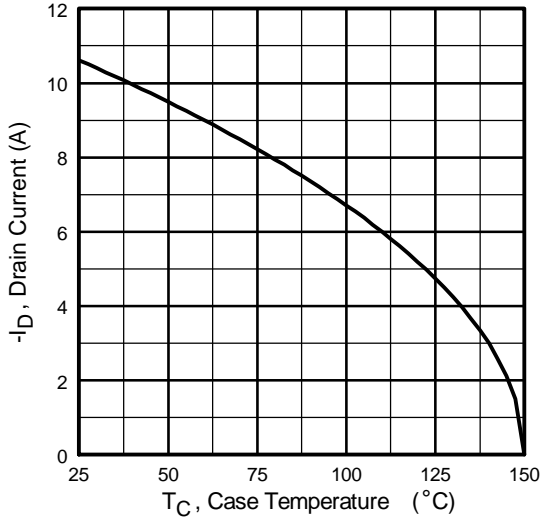

Fig 9. Maximum Drain Current Vs. Case Temperature

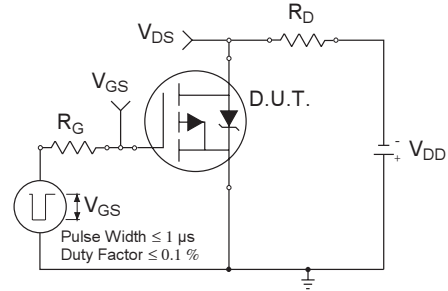

Fig 10a. Switching Time Test Circuit

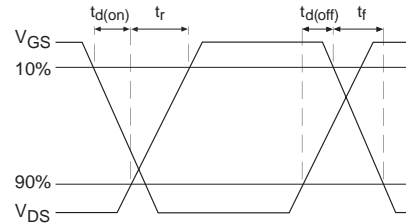

Fig 10b. Switching Time Waveforms

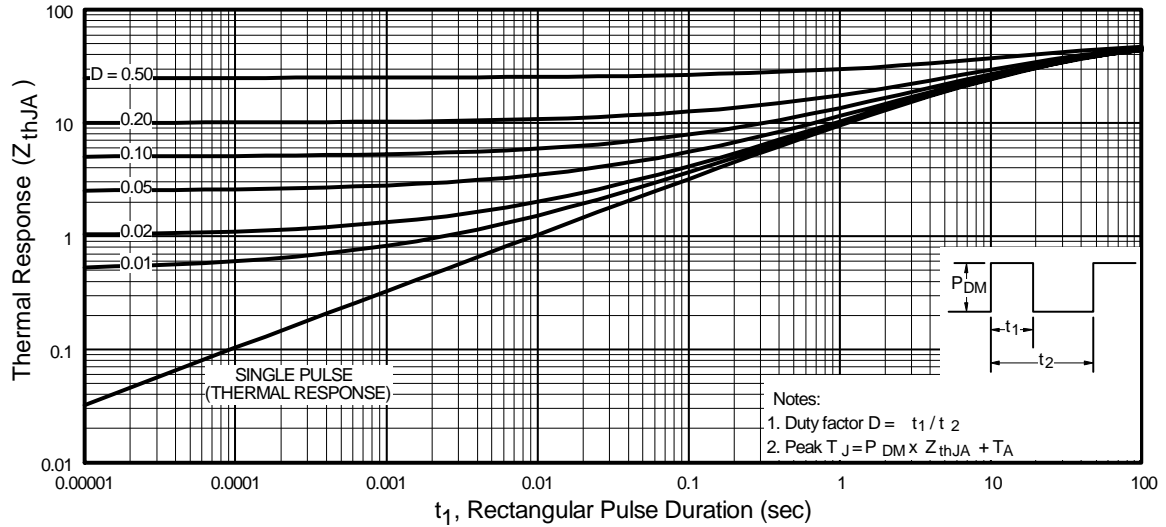

Fig 11. Maximum Effective Transient Thermal Impedance, Junction-to-Ambient

IRF7240PbF

International
IR Rectifier

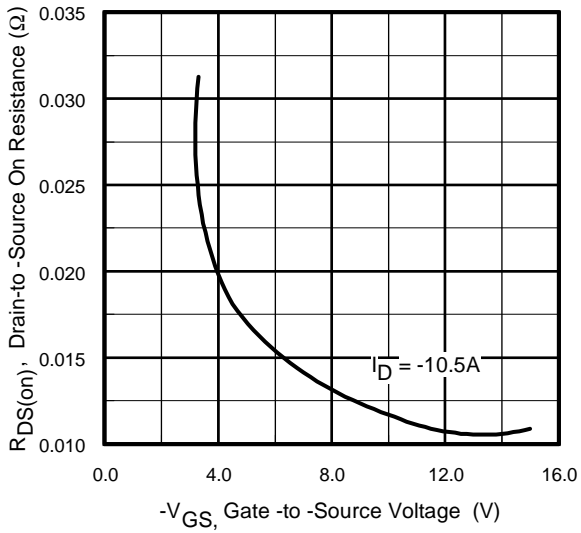

Fig 12. Typical On-Resistance Vs. Gate Voltage

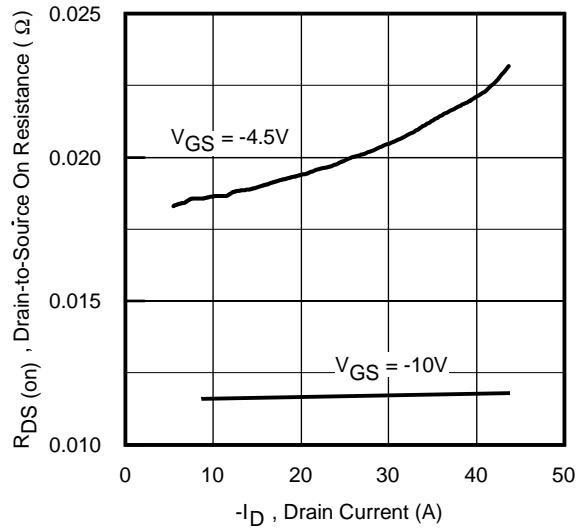

Fig 13. Typical On-Resistance Vs. Drain Current



Fig 14a. Basic Gate Charge Waveform

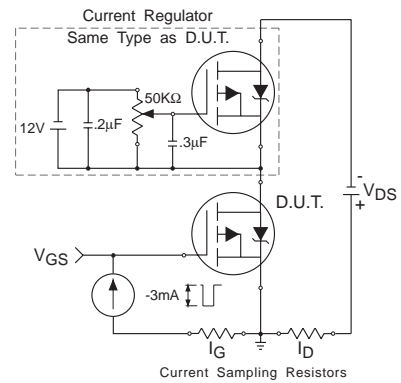

Fig 14b. Gate Charge Test Circuit

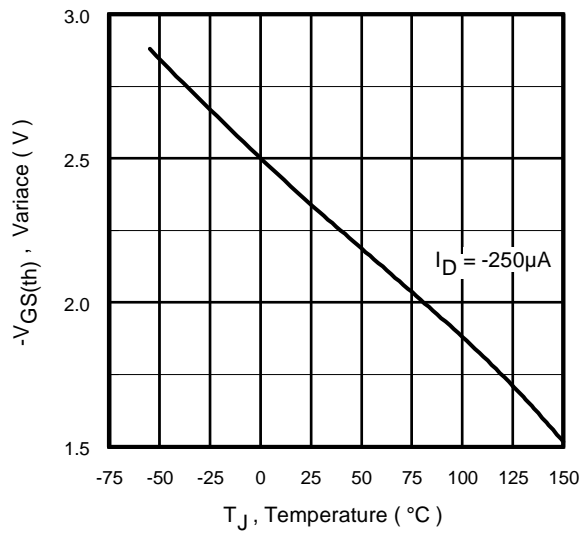

Fig 15. Typical V_{GS(th)} Variance Vs. Junction Temperature

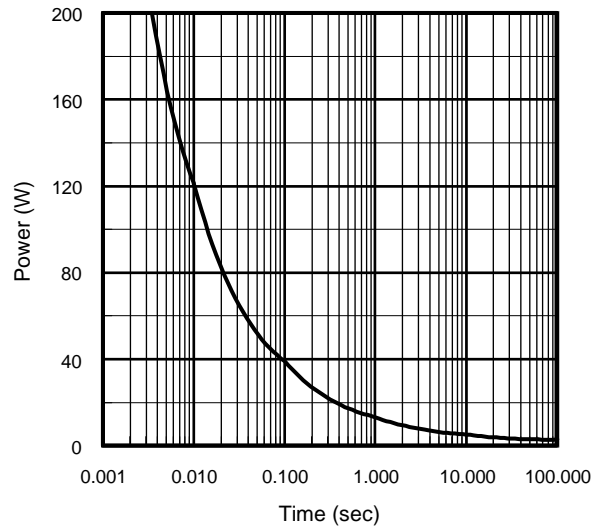

Fig 16. Typical Power Vs. Time

IRF7240PbF

International
IR Rectifier

SO-8 Package Outline

Dimensions are shown in millimeters (inches)

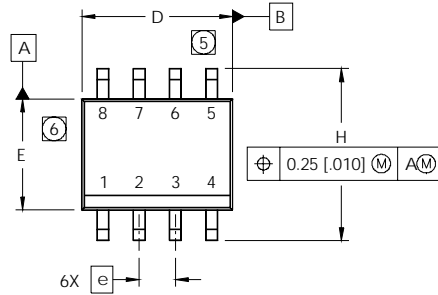

DIM	INCHES		MILLIMETERS	
	MIN	MAX	MIN	MAX
A	.0532	.0688	1.35	1.75
A1	.0040	.0098	0.10	0.25
b	.013	.020	0.33	0.51
c	.0075	.0098	0.19	0.25
D	.189	.1968	4.80	5.00
E	.1497	.1574	3.80	4.00
e	.050 BASIC		1.27 BASIC	
e1	.025 BASIC		0.635 BASIC	
H	.2284	.2440	5.80	6.20
K	.0099	.0196	0.25	0.50
L	.016	.050	0.40	1.27
y	0°	8°	0°	8°

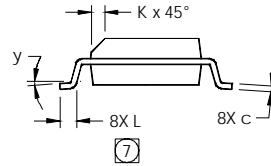
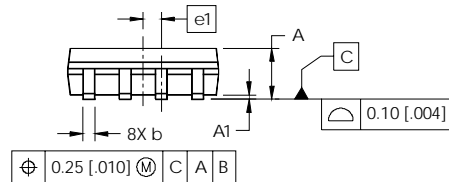

NOTES:

1. DIMENSIONING & TOLERANCING PER ASME Y14.5M-1994.
2. CONTROLLING DIMENSION: MILLIMETER
3. DIMENSIONS ARE SHOWN IN MILLIMETERS [INCHES].
4. OUTLINE CONFORMS TO JEDEC OUTLINE MS-012AA.
- ⑤ DIMENSION DOES NOT INCLUDE MOLD PROTRUSIONS. MOLD PROTRUSIONS NOT TO EXCEED 0.15 [0.006].
- ⑥ DIMENSION DOES NOT INCLUDE MOLD PROTRUSIONS. MOLD PROTRUSIONS NOT TO EXCEED 0.25 [0.010].
- ⑦ DIMENSION IS THE LENGTH OF LEAD FOR SOLDERING TO A SUBSTRATE.

FOOTPRINT

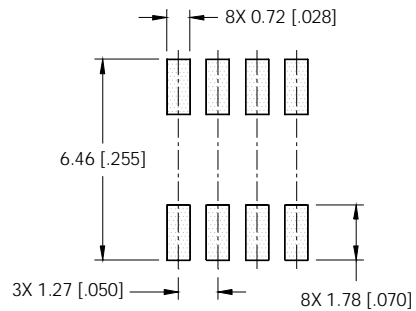

SO-8 Part Marking

EXAMPLE: THIS IS AN IRF7101 (MOSFET)

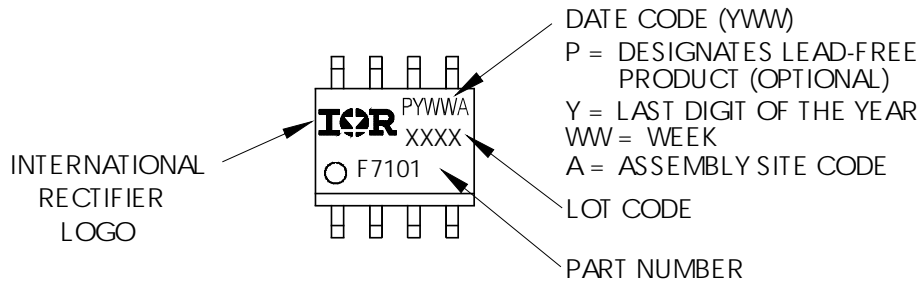

SO-8 Tape and Reel

Dimensions are shown in millimeters (inches)

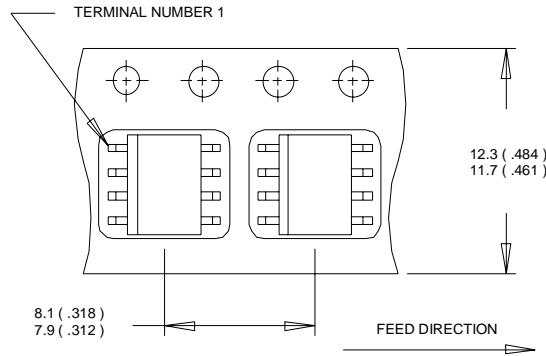

- NOTES:
1. CONTROLLING DIMENSION : MILLIMETER.
 2. ALL DIMENSIONS ARE SHOWN IN MILLIMETERS(INCHES).
 3. OUTLINE CONFORMS TO EIA-481 & EIA-541.

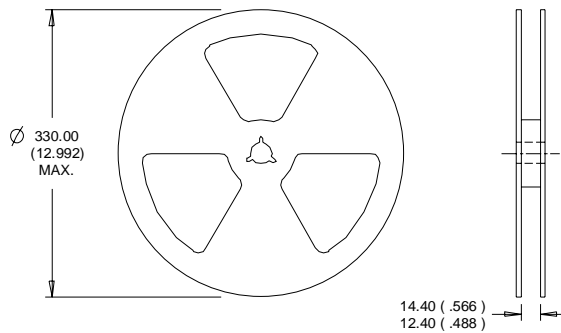

- NOTES :
1. CONTROLLING DIMENSION : MILLIMETER.
 2. OUTLINE CONFORMS TO EIA-481 & EIA-541.

Data and specifications subject to change without notice.
 This product has been designed and qualified for the Consumer market.
 Qualifications Standards can be found on IR's Web site.

IMPORTANT NOTICE

The information given in this document shall in no event be regarded as a guarantee of conditions or characteristics ("Beschaffheitsgarantie").

With respect to any examples, hints or any typical values stated herein and/or any information regarding the application of the product, Infineon Technologies hereby disclaims any and all warranties and liabilities of any kind, including without limitation warranties of non-infringement of intellectual property rights of any third party.

In addition, any information given in this document is subject to customer's compliance with its obligations stated in this document and any applicable legal requirements, norms and standards concerning customer's products and any use of the product of Infineon Technologies in customer's applications.

The data contained in this document is exclusively intended for technically trained staff. It is the responsibility of customer's technical departments to evaluate the suitability of the product for the intended application and the completeness of the product information given in this document with respect to such application.

For further information on the product, technology, delivery terms and conditions and prices please contact your nearest Infineon Technologies office (www.infineon.com).

WARNINGS

Due to technical requirements products may contain dangerous substances. For information on the types in question please contact your nearest Infineon Technologies office.

Except as otherwise explicitly approved by Infineon Technologies in a written document signed by authorized representatives of Infineon Technologies, Infineon Technologies' products may not be used in any applications where a failure of the product or any consequences of the use thereof can reasonably be expected to result in personal injury.

X-ON Electronics

Largest Supplier of Electrical and Electronic Components

Click to view similar products for [MOSFET](#) category:

Click to view products by [Infineon](#) manufacturer:

Other Similar products are found below :

[614233C](#) [648584F](#) [IRFD120](#) [JANTX2N5237](#) [FCA20N60_F109](#) [FDZ595PZ](#) [2SK2545\(Q,T\)](#) [405094E](#) [423220D](#) [TPCC8103,L1Q\(CM](#)
[MIC4420CM-TR](#) [VN1206L](#) [614234A](#) [715780A](#) [NTNS3166NZT5G](#) [SSM6J414TU,LF\(T](#) [751625C](#) [BUK954R8-60E](#) [GROUP A 5962-](#)
[8877003PA](#) [NTE6400](#) [SQJ402EP-T1-GE3](#) [2SK2614\(TE16L1,Q\)](#) [2N7002KW-FAI](#) [DMN1017UCP3-7](#) [EFC2J004NUZTDG](#) [ECH8691-TL-W](#)
[FCAB21350L1](#) [P85W28HP2F-7071](#) [DMN1053UCP4-7](#) [NTE221](#) [NTE222](#) [NTE2384](#) [NTE2903](#) [NTE2941](#) [NTE2945](#) [NTE2946](#) [NTE2960](#)
[NTE2967](#) [NTE2969](#) [NTE2976](#) [NTE6400A](#) [NTE2910](#) [NTE2916](#) [NTE2956](#) [NTE2911](#) [DMN2080UCB4-7](#) [TK10A80W,S4X\(S](#)
[SSM6P69NU,LF](#) [DMP22D4UFO-7B](#) [DMN1006UCA6-7](#)