

IRF7526D1PbF

FETKY™ MOSFET & Schottky Diode

- Co-packaged HEXFET® Power MOSFET and Schottky Diode
- P-Channel HEXFET
- Low V_F Schottky Rectifier
- Generation 5 Technology
- Micro8™ Footprint
- Lead-Free

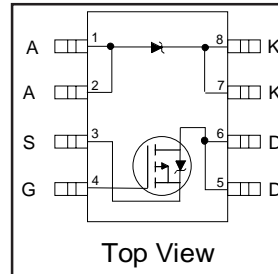

| |
|---------------------------|
| $V_{DSS} = -30V$ |
| $R_{DS(on)} = 0.20\Omega$ |
| Schottky $V_f = 0.39V$ |

Description

The **FETKY™** family of co-packaged HEXFETs and Schottky diodes offer the designer an innovative board space saving solution for switching regulator applications. Generation 5 HEXFETs utilize advanced processing techniques to achieve extremely low on-resistance per silicon area. Combining this technology with International Rectifier's low forward drop Schottky rectifiers results in an extremely efficient device suitable for use in a wide variety of portable electronics applications like cell phone, PDA, etc.

The new Micro8™ package, with half the footprint area of the standard SO-8, provides the smallest footprint available in an SOIC outline. This makes the Micro8™ an ideal device for applications where printed circuit board space is at a premium. The low profile (<1.1mm) of the Micro8™ will allow it to fit easily into extremely thin application environments such as portable electronics and PCMCIA cards.

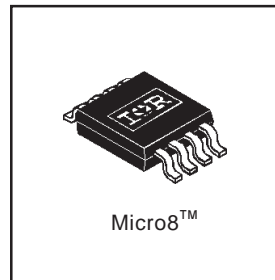

Absolute Maximum Ratings

| Parameter | Maximum | Units |
|--------------------------|-------------|-------|
| $I_D @ T_A = 25^\circ C$ | -2.0 | A |
| $I_D @ T_A = 70^\circ C$ | -1.6 | |
| I_{DM} | -16 | |
| $P_D @ T_A = 25^\circ C$ | 1.25 | W |
| $P_D @ T_A = 70^\circ C$ | 0.8 | |
| | 10 | mW/°C |
| V_{GS} | ± 20 | V |
| dv/dt | -5.0 | V/ns |
| T_J, T_{STG} | -55 to +150 | °C |

Thermal Resistance Ratings

| Parameter | Maximum | Units |
|-----------------|---------|-------|
| $R_{\theta JA}$ | 100 | °C/W |

Notes:

- ① Repetitive rating – pulse width limited by max. junction temperature (see Fig. 9)
- ② $I_{SD} \leq -1.2A$, $di/dt \leq 160A/\mu s$, $V_{DD} \leq V_{(BR)DSS}$, $T_J \leq 150^\circ C$
- ③ Pulse width $\leq 300\mu s$ – duty cycle $\leq 2\%$
- ④ When mounted on 1 inch square copper board to approximate typical multi-layer PCB thermal resistance

www.irf.com

MOSFET Electrical Characteristics @ T_J = 25°C (unless otherwise specified)

| | Parameter | Min. | Typ. | Max. | Units | Conditions |
|----------------------|--------------------------------------|------|------|------|-------|--|
| V _{(BR)DSS} | Drain-to-Source Breakdown Voltage | -30 | — | — | V | V _{GS} = 0V, I _D = -250μA |
| R _{DS(on)} | Static Drain-to-Source On-Resistance | — | 0.17 | 0.20 | Ω | V _{GS} = -10V, I _D = -1.2A ③ |
| | | — | 0.30 | 0.40 | | V _{GS} = -4.5V, I _D = -0.60A ③ |
| V _{GS(th)} | Gate Threshold Voltage | -1.0 | — | — | V | V _{DS} = V _{GS} , I _D = -250μA |
| g _{fs} | Forward Transconductance | 0.94 | — | — | S | V _{DS} = -10V, I _D = -0.60A |
| I _{DSS} | Drain-to-Source Leakage Current | — | — | -1.0 | μA | V _{DS} = -24V, V _{GS} = 0V |
| | | — | — | -25 | | V _{DS} = -24V, V _{GS} = 0V, T _J = 125°C |
| I _{GSS} | Gate-to-Source Forward Leakage | — | — | -100 | nA | V _{GS} = -20V |
| | Gate-to-Source Reverse Leakage | — | — | 100 | | V _{GS} = 20V |
| Q _g | Total Gate Charge | — | 7.5 | 11 | nC | I _D = -1.2A |
| Q _{gs} | Gate-to-Source Charge | — | 1.3 | 1.9 | | V _{DS} = -24V |
| Q _{gd} | Gate-to-Drain ("Miller") Charge | — | 2.5 | 3.7 | | V _{GS} = -10V, See Fig. 6 ③ |
| t _{d(on)} | Turn-On Delay Time | — | 9.7 | — | ns | V _{DD} = -15V |
| t _r | Rise Time | — | 12 | — | | I _D = -1.2A |
| t _{d(off)} | Turn-Off Delay Time | — | 19 | — | | R _G = 6.2Ω |
| t _f | Fall Time | — | 9.3 | — | | R _D = 12Ω, ③ |
| C _{iss} | Input Capacitance | — | 180 | — | pF | V _{GS} = 0V |
| C _{oss} | Output Capacitance | — | 87 | — | | V _{DS} = -25V |
| C _{rss} | Reverse Transfer Capacitance | — | 42 | — | | f = 1.0MHz, See Fig. 5 |

MOSFET Source-Drain Ratings and Characteristics

| | Parameter | Min. | Typ. | Max. | Units | Conditions |
|-----------------|--|------|------|-------|-------|---|
| I _S | Continuous Source Current (Body Diode) | — | — | -1.25 | A | |
| I _{SM} | Pulsed Source Current (Body Diode) | — | — | -9.6 | | |
| V _{SD} | Body Diode Forward Voltage | — | — | -1.2 | V | T _J = 25°C, I _S = -1.2A, V _{GS} = 0V |
| t _{rr} | Reverse Recovery Time (Body Diode) | — | 30 | 45 | ns | T _J = 25°C, I _F = -1.2A |
| Q _{rr} | Reverse Recovery Charge | — | 37 | 55 | nC | di/dt = 100A/μs ③ |

Schottky Diode Maximum Ratings

| | Parameter | Max. | Units | Conditions |
|--------------------|--|------|-------|---|
| I _{F(av)} | Max. Average Forward Current | 1.9 | A | 50% Duty Cycle. Rectangular Wave, T _A = 25°C See Fig. 14 T _A = 70°C |
| | | 1.3 | | |
| I _{SM} | Max. peak one cycle Non-repetitive Surge current | 120 | A | Following any rated load condition & with V _{RRM} applied |
| | | 11 | | |

Schottky Diode Electrical Specifications

| | Parameter | Max. | Units | Conditions |
|-----------------|------------------------------|------|-------|--|
| V _{FM} | Max. Forward voltage drop | 0.50 | V | I _F = 1.0A, T _J = 25°C |
| | | 0.62 | | I _F = 2.0A, T _J = 25°C |
| | | 0.39 | | I _F = 1.0A, T _J = 125°C |
| | | 0.57 | | I _F = 2.0A, T _J = 125°C. |
| I _{RM} | Max. Reverse Leakage current | 0.06 | mA | V _R = 30V, T _J = 25°C |
| | | 16 | | T _J = 125°C |
| C _t | Max. Junction Capacitance | 92 | pF | V _R = 5Vdc (100kHz to 1 MHz) 25°C |
| dv/dt | Max. Voltage Rate of Charge | 3600 | V/μs | Rated V _R |

(HEXFET is the reg. TM for International Rectifier Power MOSFET's)

Power Mosfet Characteristics

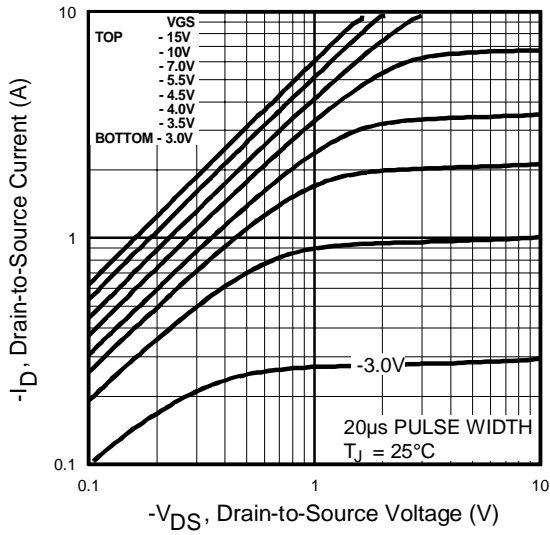

Fig 1. Typical Output Characteristics

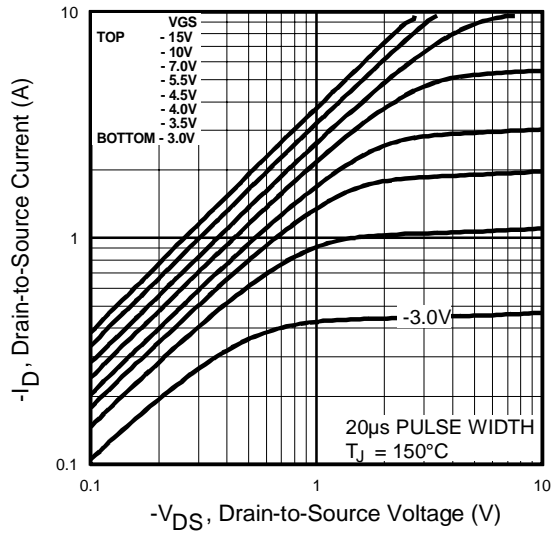

Fig 2. Typical Output Characteristics

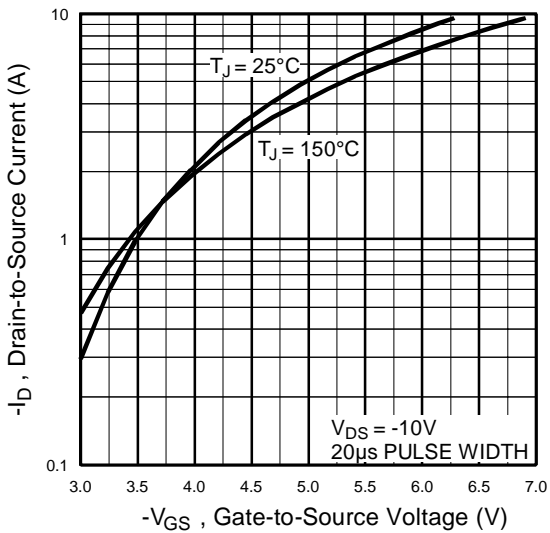

Fig 3. Typical Transfer Characteristics

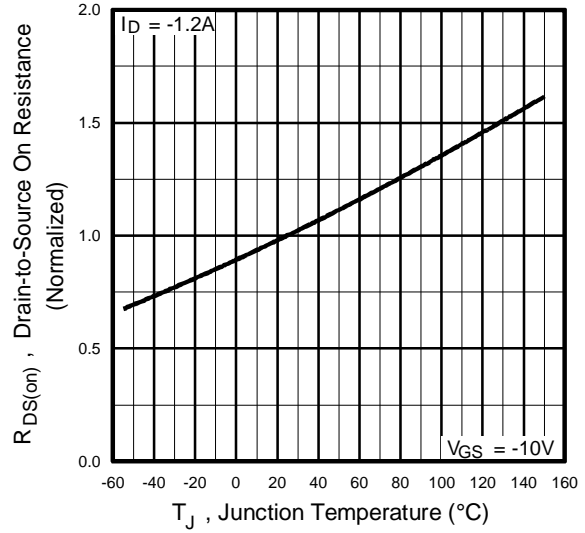

Fig 4. Normalized On-Resistance Vs. Temperature

Power Mosfet Characteristics

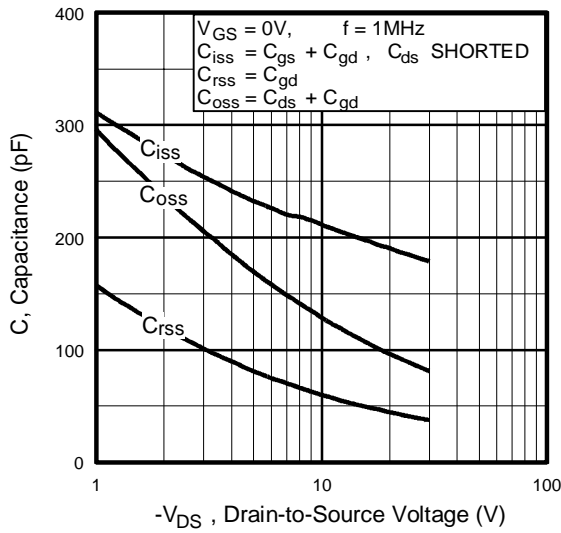

Fig 5. Typical Capacitance Vs. Drain-to-Source Voltage

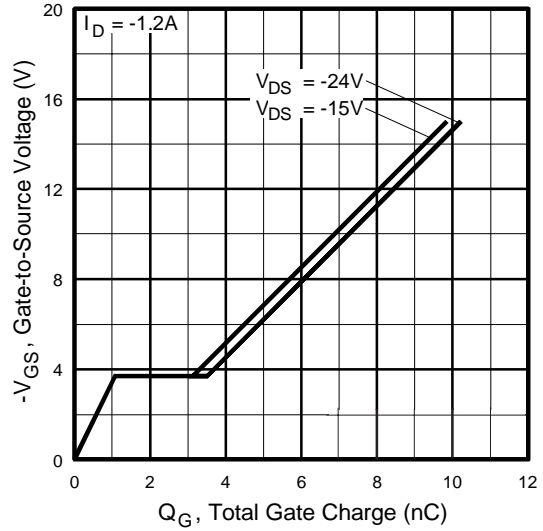

Fig 6. Typical Gate Charge Vs. Gate-to-Source Voltage

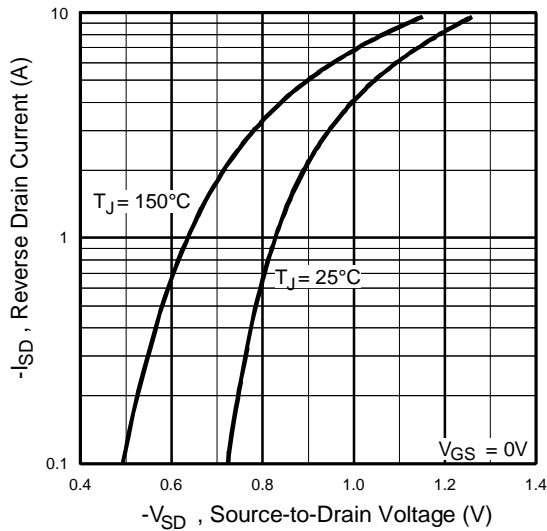

Fig 7. Typical Source-Drain Diode Forward Voltage

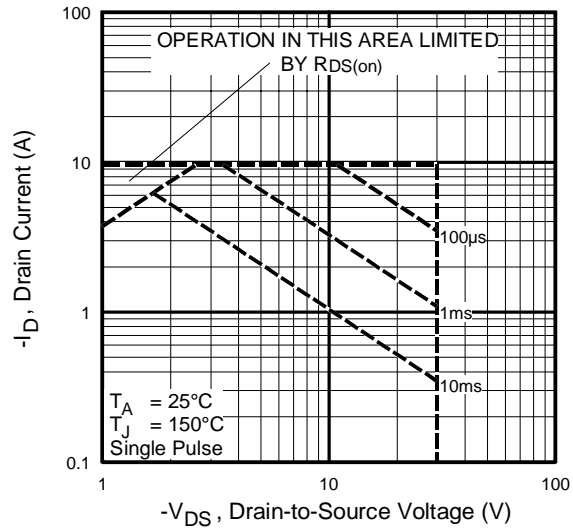

Fig 8. Maximum Safe Operating Area

Power Mosfet Characteristics

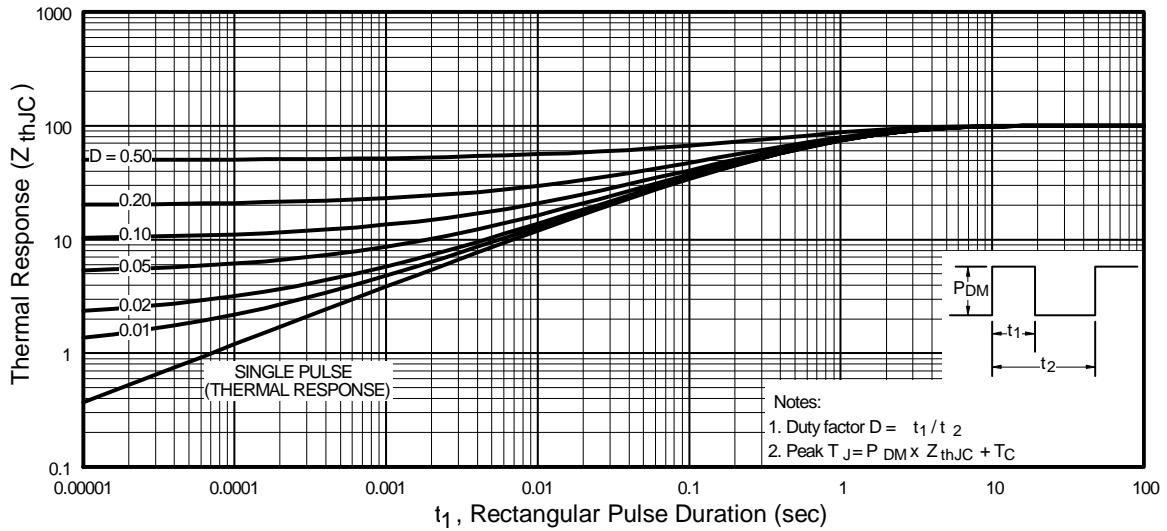

Fig 9. Maximum Effective Transient Thermal Impedance, Junction-to-Ambient

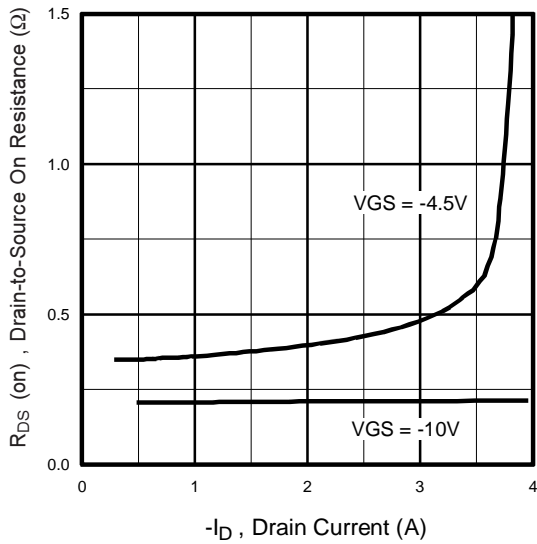

Fig 10. Typical On-Resistance Vs. Drain Current

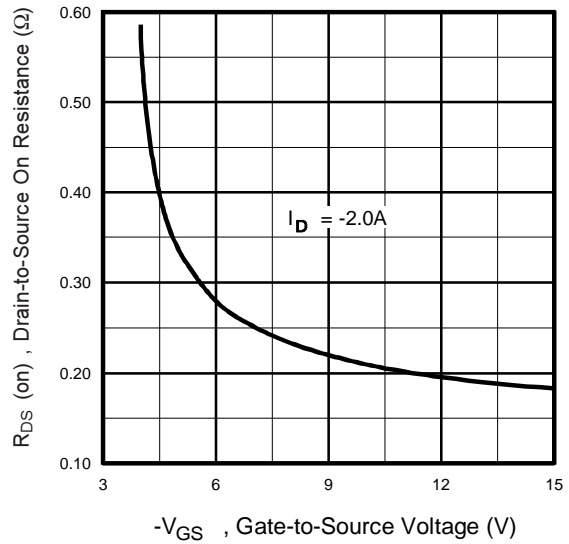

Fig 11. Typical On-Resistance Vs. Gate Voltage

Schottky Diode Characteristics

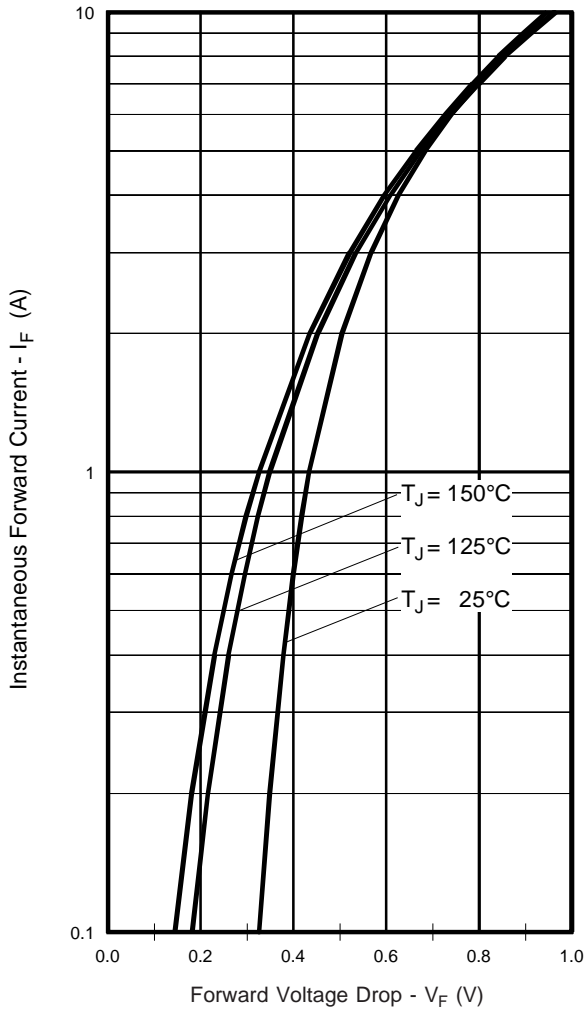

Fig. 12 - Typical Forward Voltage Drop Characteristics

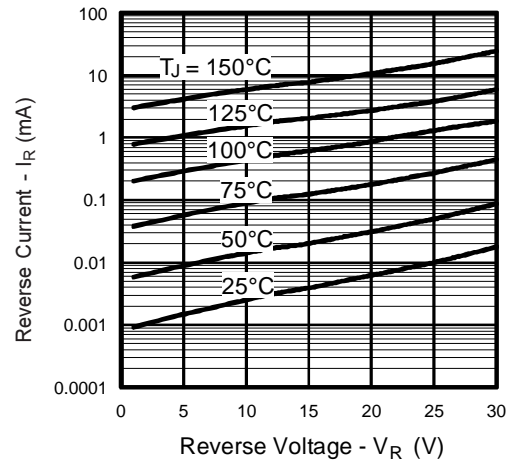

Fig. 13 - Typical Values of Reverse Current Vs. Reverse Voltage

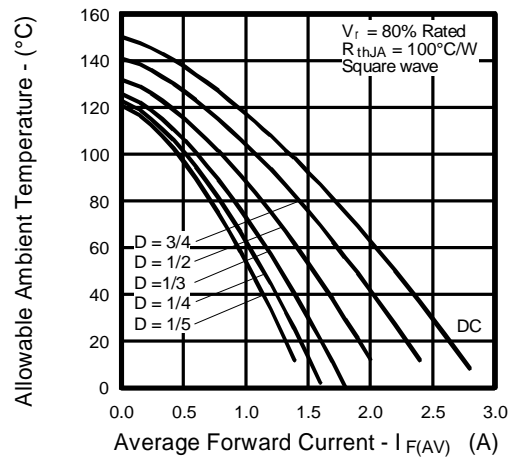

Fig.14 - Maximum Allowable Ambient Temp. Vs. Forward Current

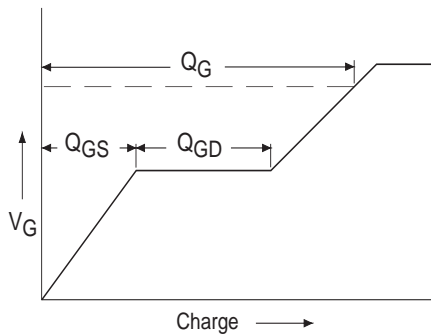

Fig 15a. Basic Gate Charge Waveform

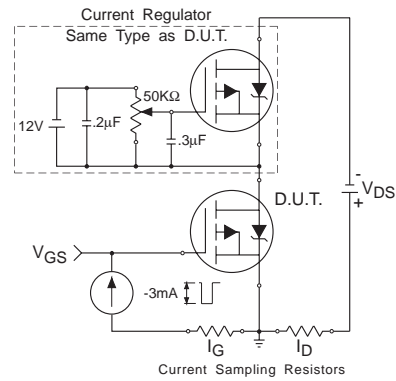

Fig 15b. Gate Charge Test Circuit

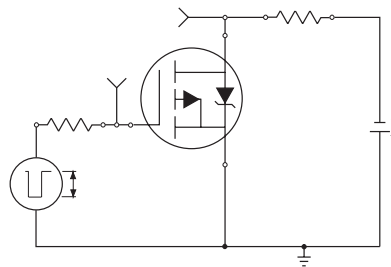

Fig 16a. Switching Time Test Circuit

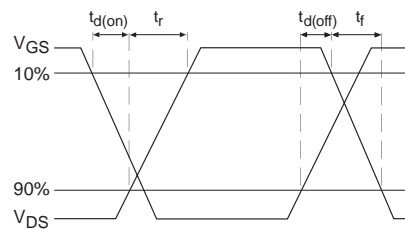
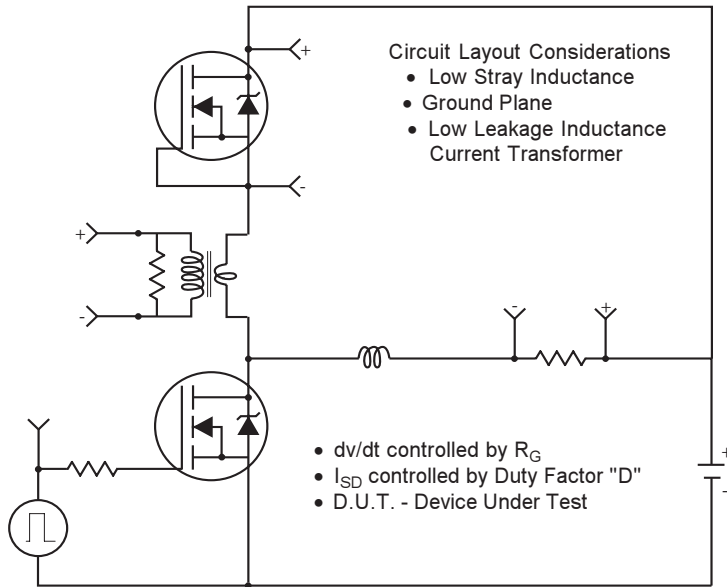

Fig 16b. Switching Time Waveforms

Peak Diode Recovery dv/dt Test Circuit



* Reverse Polarity for P-Channel

** Use P-Channel Driver for P-Channel Measurements

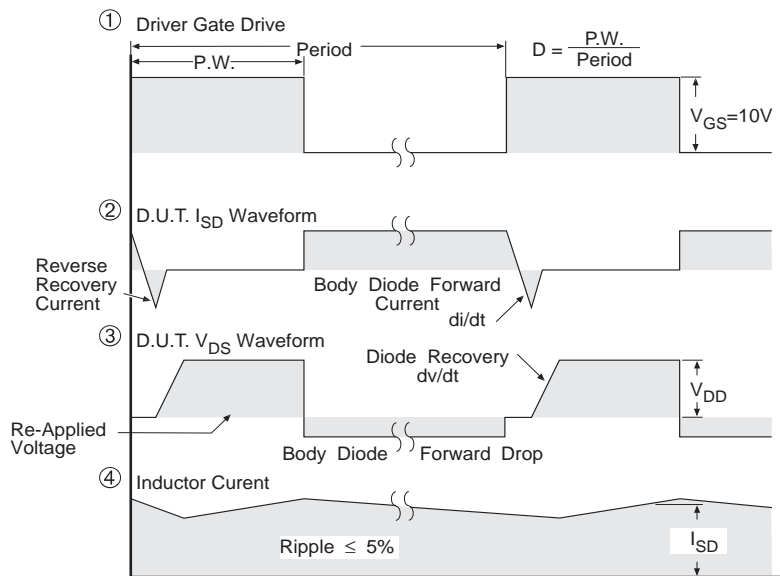

*** $V_{GS} = 5.0V$ for Logic Level and 3V Drive Devices

Fig 17 For P Channel HEXFETS

Micro8 Package Outline

Dimensions are shown in millimeters (inches)

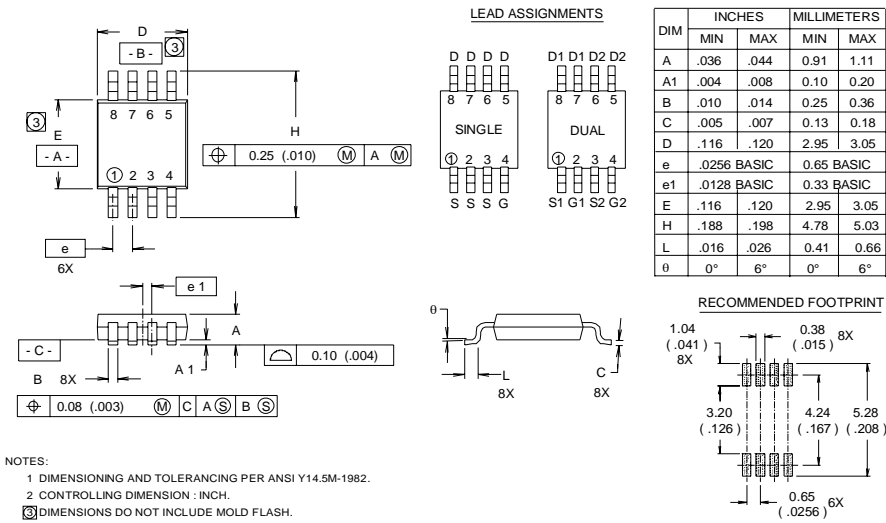

Micro8 Part Marking Information

EXAMPLE: THIS IS AN IRF7501

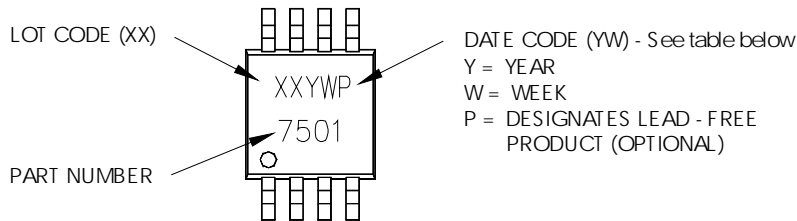

WW = (1-26) IF PRECEDED BY LAST DIGIT OF CALENDAR YEAR

| YEAR | Y | WORK WEEK | W |
|------|---|-----------|---|
| 2001 | 1 | 01 | A |
| 2002 | 2 | 02 | B |
| 2003 | 3 | 03 | C |
| 2004 | 4 | 04 | D |
| 2005 | 5 | | |
| 2006 | 6 | | |
| 2007 | 7 | | |
| 2008 | 8 | | |
| 2009 | 9 | | |
| 2010 | 0 | 24 | X |
| | | 25 | Y |
| | | 26 | Z |

WW = (27-52) IF PRECEDED BY A LETTER

| YEAR | Y | WORK WEEK | W |
|------|---|-----------|---|
| 2001 | A | 27 | A |
| 2002 | B | 28 | B |
| 2003 | C | 29 | C |
| 2004 | D | 30 | D |
| 2005 | E | | |
| 2006 | F | | |
| 2007 | G | | |
| 2008 | H | | |
| 2009 | J | | |
| 2010 | K | 50 | X |
| | | 51 | Y |
| | | 52 | Z |

IRF7526D1PbF

International
IR Rectifier

Micro8 Tape & Reel Information

Dimensions are shown in millimeters (inches)

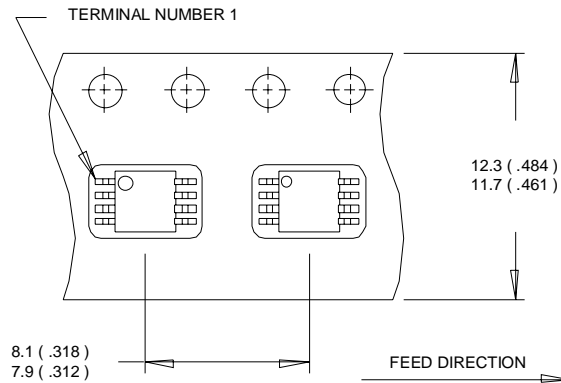

NOTES:

1. OUTLINE CONFORMS TO EIA-481 & EIA-541.
2. CONTROLLING DIMENSION : MILLIMETER.

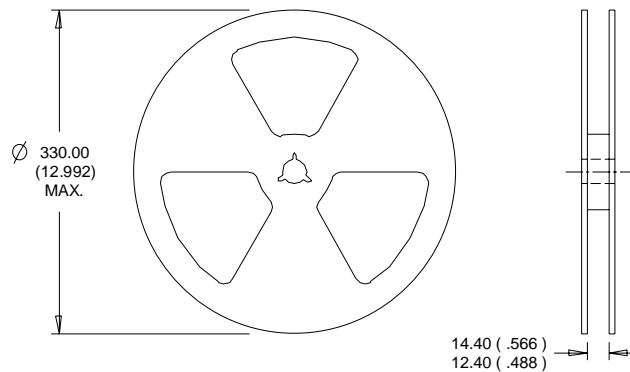

NOTES :

1. CONTROLLING DIMENSION : MILLIMETER.
2. OUTLINE CONFORMS TO EIA-481 & EIA-541.

Data and specifications subject to change without notice.
This product has been designed and qualified for the Consumer market.
Qualifications Standards can be found on IR's Web site.

International
IR Rectifier

IR WORLD HEADQUARTERS: 233 Kansas St., El Segundo, California 90245, USA Tel: (310) 252-7105
TAC Fax: (310) 252-7903

Visit us at www.irf.com for sales contact information. 02/05

www.irf.com

X-ON Electronics

Largest Supplier of Electrical and Electronic Components

Click to view similar products for [MOSFET](#) category:

Click to view products by [Infineon](#) manufacturer:

Other Similar products are found below :

[614233C](#) [648584F](#) [IRFD120](#) [JANTX2N5237](#) [FCA20N60_F109](#) [FDZ595PZ](#) [2SK2545\(Q,T\)](#) [405094E](#) [423220D](#) [TPCC8103,L1Q\(CM](#)
[MIC4420CM-TR](#) [VN1206L](#) [SBVS138LT1G](#) [614234A](#) [715780A](#) [NTNS3166NZT5G](#) [SSM6J414TU,LF\(T](#) [751625C](#) [BUK954R8-60E](#)
[NTE6400](#) [SQJ402EP-T1-GE3](#) [2SK2614\(TE16L1,Q\)](#) [2N7002KW-FAI](#) [DMN1017UCP3-7](#) [EFC2J004NUZTDG](#) [ECH8691-TL-W](#)
[FCAB21350L1](#) [P85W28HP2F-7071](#) [DMN1053UCP4-7](#) [NTE221](#) [NTE222](#) [NTE2384](#) [NTE2903](#) [NTE2941](#) [NTE2945](#) [NTE2946](#) [NTE2960](#)
[NTE2967](#) [NTE2969](#) [NTE2976](#) [NTE455](#) [NTE6400A](#) [NTE2910](#) [NTE2916](#) [NTE2956](#) [NTE2911](#) [DMN2080UCB4-7](#) [TK10A80W,S4X\(S](#)
[SSM6P69NU,LF](#) [DMP22D4UFO-7B](#)