

IRF8721PbF

HEXFET® Power MOSFET

Applications

- Control MOSFET of Sync-Buck Converters used for Notebook Processor Power
- Control MOSFET for Isolated DC-DC Converters in Networking Systems

Benefits

- Very Low Gate Charge
- Low $R_{DS(on)}$ at 4.5V V_{GS}
- Low Gate Impedance
- Fully Characterized Avalanche Voltage and Current
- 20V V_{GS} Max. Gate Rating
- Lead-Free

Description

The IRF8721PbF incorporates the latest HEXFET Power MOSFET Silicon Technology into the industry standard SO-8 package. The IRF8721PbF has been optimized for parameters that are critical in synchronous buck operation including $R_{ds(on)}$ and gate charge to reduce both conduction and switching losses. The reduced total losses make this product ideal for high efficiency DC-DC converters that power the latest generation of processors for Notebook and Netcom applications.

Absolute Maximum Ratings

	Parameter	Max.	Units
V_{DS}	Drain-to-Source Voltage	30	V
V_{GS}	Gate-to-Source Voltage	± 20	
$I_D @ T_A = 25^\circ\text{C}$	Continuous Drain Current, $V_{GS} @ 10\text{V}$	14	A
$I_D @ T_A = 70^\circ\text{C}$	Continuous Drain Current, $V_{GS} @ 10\text{V}$	11	
I_{DM}	Pulsed Drain Current ①	110	
$P_D @ T_A = 25^\circ\text{C}$	Power Dissipation	2.5	W
$P_D @ T_A = 70^\circ\text{C}$	Power Dissipation	1.6	
	Linear Derating Factor	0.02	W/°C
T_J	Operating Junction and	-55 to + 150	°C
T_{STG}	Storage Temperature Range		

Thermal Resistance

	Parameter	Typ.	Max.	Units
$R_{\theta JL}$	Junction-to-Drain Lead ⑤	—	20	°C/W
$R_{\theta JA}$	Junction-to-Ambient ④⑤	—	50	

Notes ① through ⑤ are on page 9

V_{DSS}	$R_{DS(on)}$ max	Qg
30V	8.5mΩ @ $V_{GS} = 10\text{V}$	8.3nC

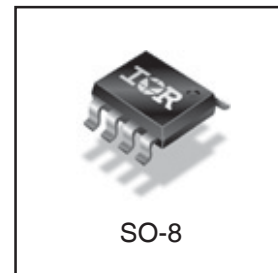
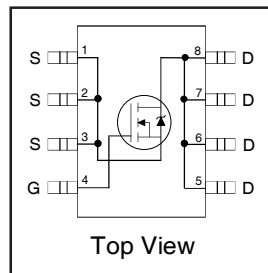

IRF8721PbF

International
IR Rectifier

Static @ $T_J = 25^\circ\text{C}$ (unless otherwise specified)

	Parameter	Min.	Typ.	Max.	Units	Conditions
BV_{DSS}	Drain-to-Source Breakdown Voltage	30	—	—	V	$V_{GS} = 0V, I_D = 250\mu A$
$\Delta BV_{DSS}/\Delta T_J$	Breakdown Voltage Temp. Coefficient	—	0.021	—	V/°C	Reference to $25^\circ\text{C}, I_D = 1mA$
$R_{DS(on)}$	Static Drain-to-Source On-Resistance	—	6.9	8.5	mΩ	$V_{GS} = 10V, I_D = 14A$ ③
		—	10.6	12.5		$V_{GS} = 4.5V, I_D = 11A$ ③
$V_{GS(th)}$	Gate Threshold Voltage	1.35	—	2.35	V	$V_{DS} = V_{GS}, I_D = 25\mu A$
$\Delta V_{GS(th)}$	Gate Threshold Voltage Coefficient	—	-6.2	—	mV/°C	
I_{DSS}	Drain-to-Source Leakage Current	—	—	1.0	μA	$V_{DS} = 24V, V_{GS} = 0V$
		—	—	150		$V_{DS} = 24V, V_{GS} = 0V, T_J = 125^\circ\text{C}$
I_{GSS}	Gate-to-Source Forward Leakage	—	—	100	nA	$V_{GS} = 20V$
	Gate-to-Source Reverse Leakage	—	—	-100		$V_{GS} = -20V$
gfs	Forward Transconductance	27	—	—	S	$V_{DS} = 15V, I_D = 11A$
Q_g	Total Gate Charge	—	8.3	12	nC	$V_{DS} = 15V$ $V_{GS} = 4.5V$ $I_D = 11A$ See Fig. 16a and 16b
Q_{gs1}	Pre-Vth Gate-to-Source Charge	—	2.0	—		
Q_{gs2}	Post-Vth Gate-to-Source Charge	—	1.0	—		
Q_{gd}	Gate-to-Drain Charge	—	3.2	—		
Q_{godr}	Gate Charge Overdrive	—	2.0	—		
Q_{sw}	Switch Charge ($Q_{gs2} + Q_{gd}$)	—	4.2	—		
Q_{oss}	Output Charge	—	5.0	—	nC	$V_{DS} = 16V, V_{GS} = 0V$
R_G	Gate Resistance	—	1.8	3.0	Ω	
$t_{d(on)}$	Turn-On Delay Time	—	8.2	—	ns	$V_{DD} = 15V, V_{GS} = 4.5V$ $I_D = 11A$ $R_G = 1.8\Omega$ See Fig. 15a
t_r	Rise Time	—	11	—		
$t_{d(off)}$	Turn-Off Delay Time	—	8.1	—		
t_f	Fall Time	—	7.0	—		
C_{iss}	Input Capacitance	—	1040	—	pF	$V_{GS} = 0V$ $V_{DS} = 15V$ $f = 1.0MHz$
C_{oss}	Output Capacitance	—	229	—		
C_{riss}	Reverse Transfer Capacitance	—	114	—		

Avalanche Characteristics

	Parameter	Typ.	Max.	Units
E_{AS}	Single Pulse Avalanche Energy ②	—	68	mJ
I_{AR}	Avalanche Current ①	—	11	A

Diode Characteristics

	Parameter	Min.	Typ.	Max.	Units	Conditions
I_S	Continuous Source Current (Body Diode)	—	—	3.1	A	MOSFET symbol showing the integral reverse p-n junction diode.
I_{SM}	Pulsed Source Current (Body Diode) ①	—	—	112		
V_{SD}	Diode Forward Voltage	—	—	1.0	V	$T_J = 25^\circ\text{C}, I_S = 11A, V_{GS} = 0V$ ③
t_{rr}	Reverse Recovery Time	—	14	21	ns	$T_J = 25^\circ\text{C}, I_F = 11A, V_{DD} = 15V$
Q_{rr}	Reverse Recovery Charge	—	15	23	nC	$di/dt = 300A/\mu s$ ③
t_{on}	Forward Turn-On Time	Intrinsic turn-on time is negligible (turn-on is dominated by LS+LD)				

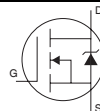

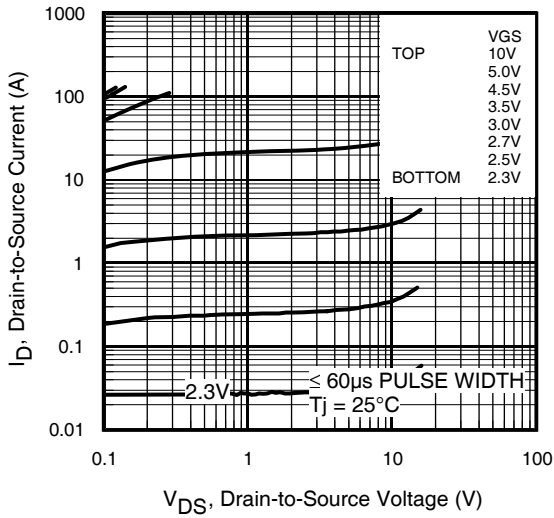

Fig 1. Typical Output Characteristics

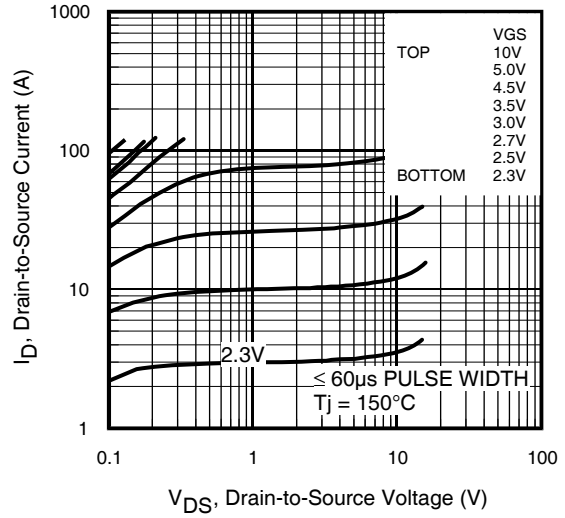

Fig 2. Typical Output Characteristics

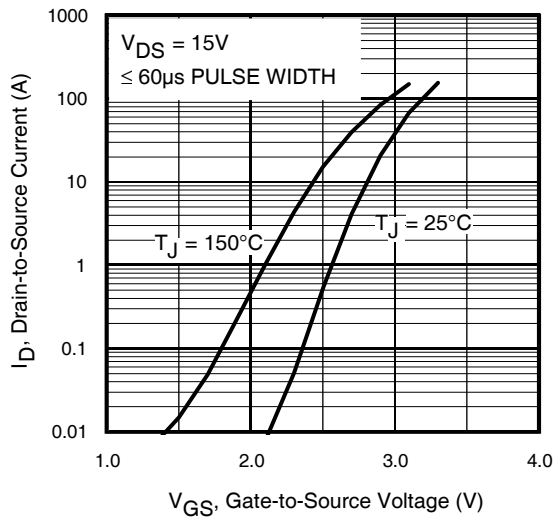

Fig 3. Typical Transfer Characteristics

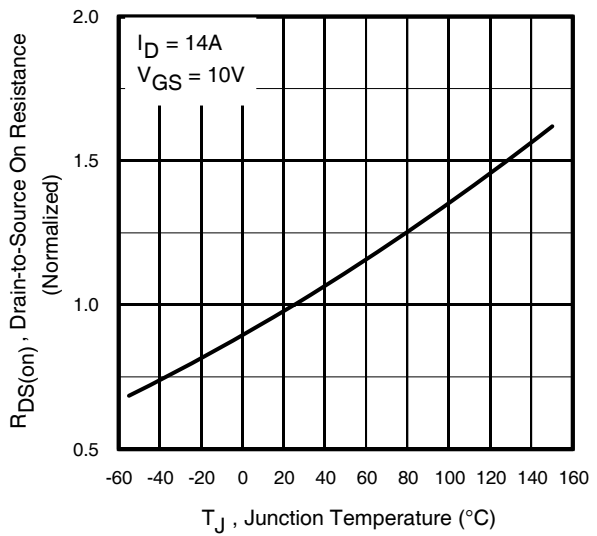

Fig 4. Normalized On-Resistance Vs. Temperature

IRF8721PbF

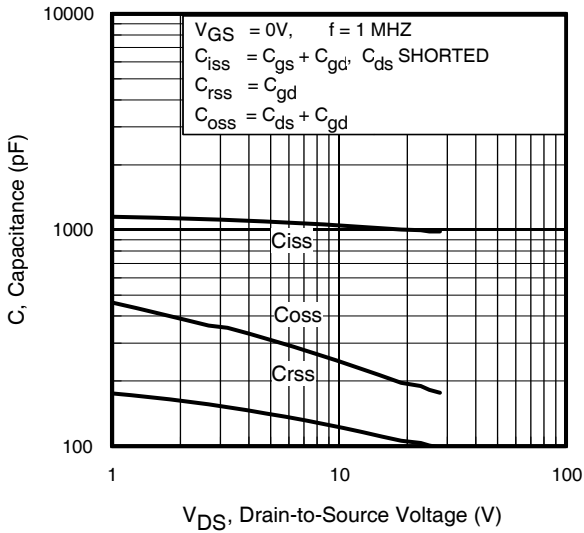

Fig 5. Typical Capacitance Vs. Drain-to-Source Voltage

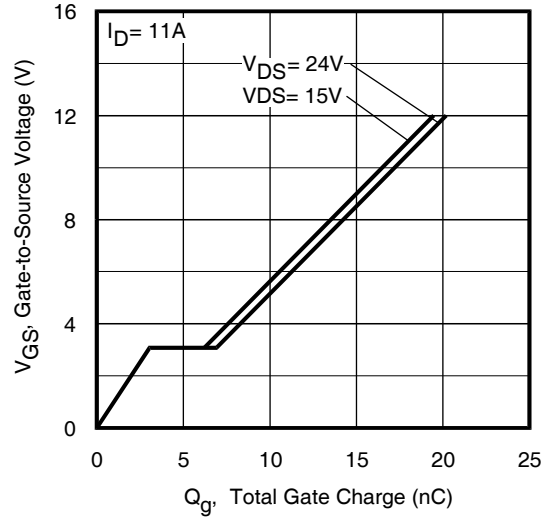

Fig 6. Typical Gate Charge Vs. Gate-to-Source Voltage

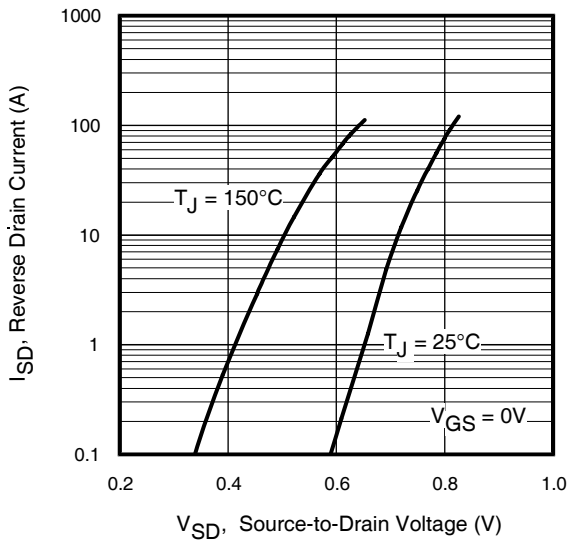

Fig 7. Typical Source-Drain Diode Forward Voltage

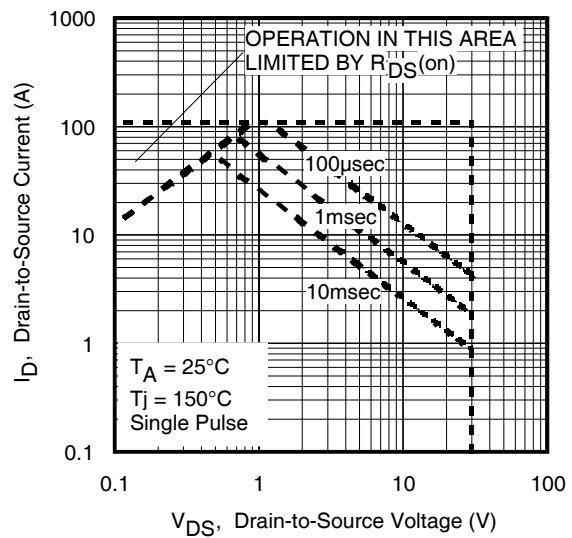

Fig 8. Maximum Safe Operating Area

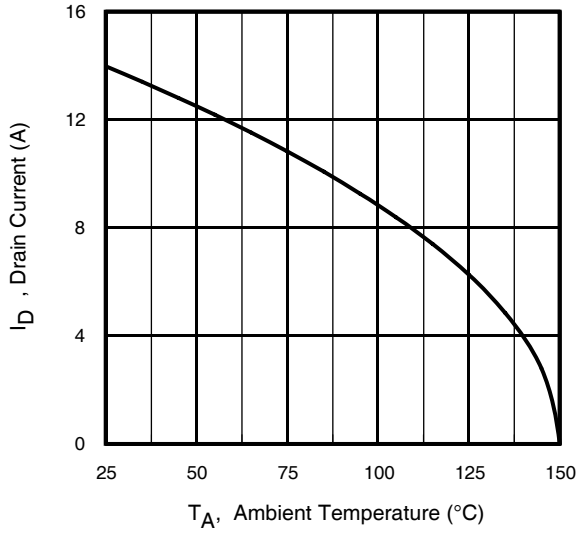

Fig 9. Maximum Drain Current Vs. Case Temperature

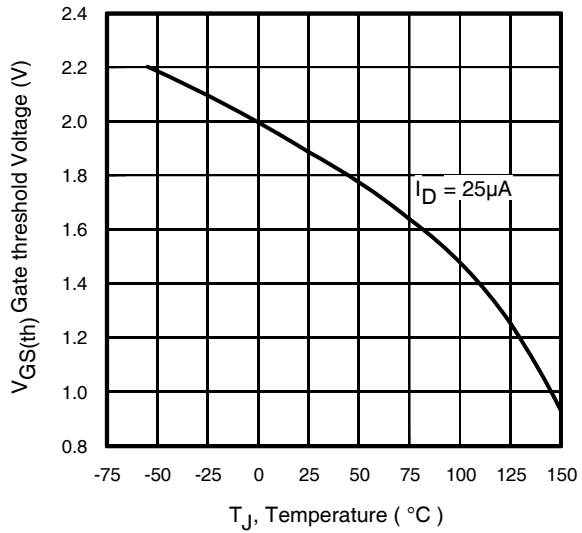

Fig 10. Threshold Voltage Vs. Temperature

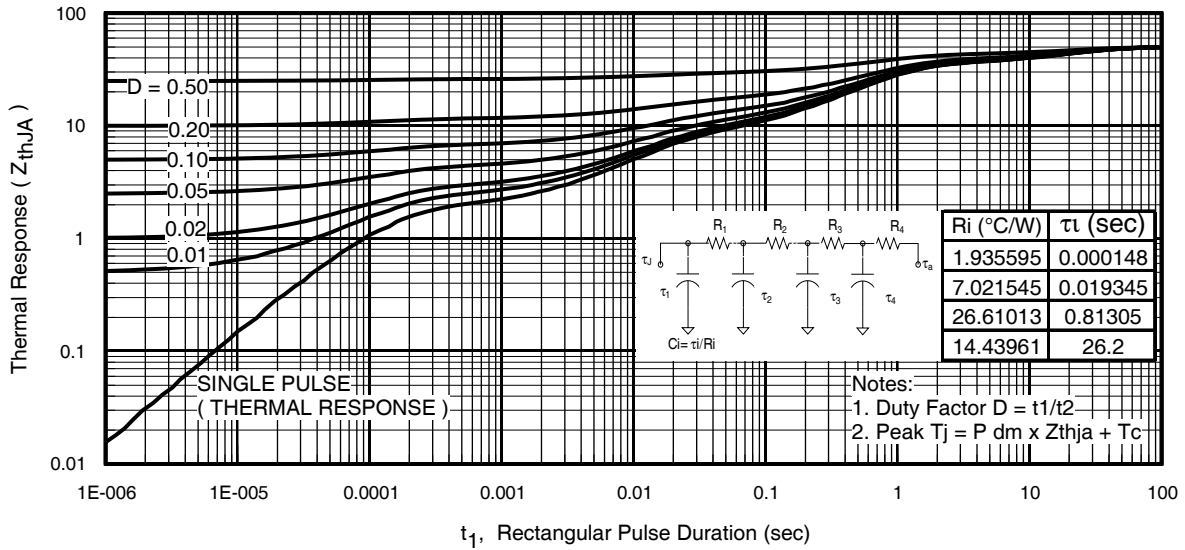

Fig 11. Maximum Effective Transient Thermal Impedance, Junction-to-Ambient

IRF8721PbF

International
IR Rectifier

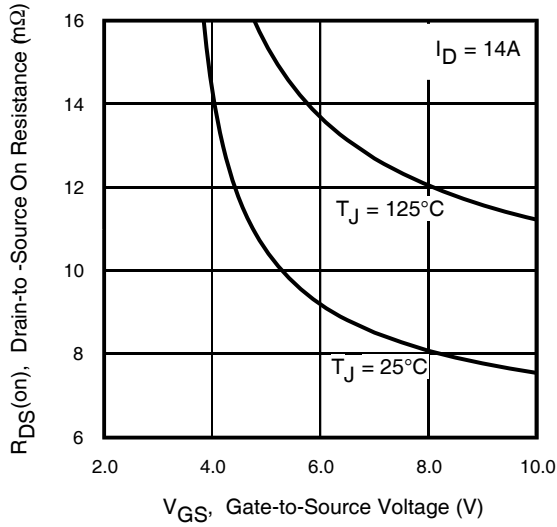

Fig 12. On-Resistance vs. Gate Voltage

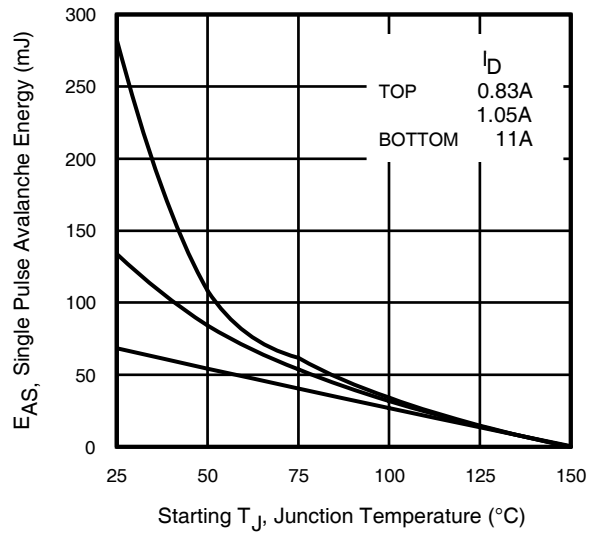

Fig 13. Maximum Avalanche Energy vs. Drain Current

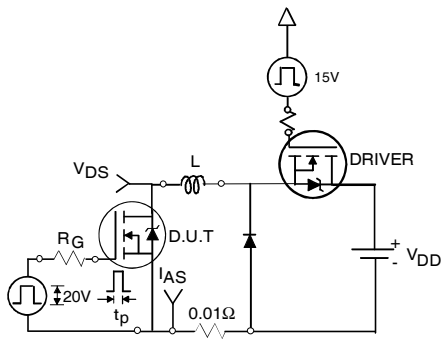

Fig 14a. Unclamped Inductive Test Circuit

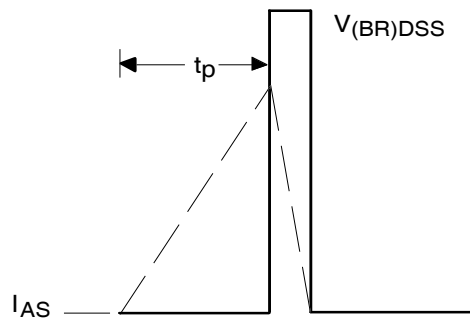

Fig 14b. Unclamped Inductive Waveforms

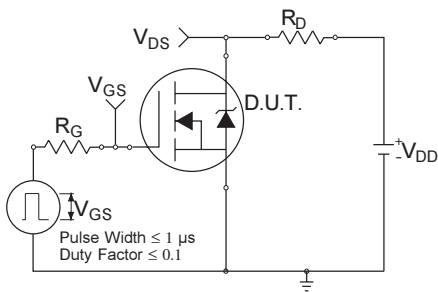

Fig 15a. Switching Time Test Circuit

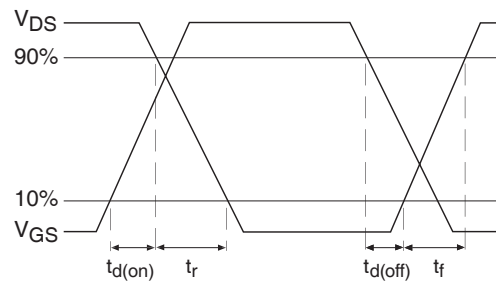

Fig 15b. Switching Time Waveforms

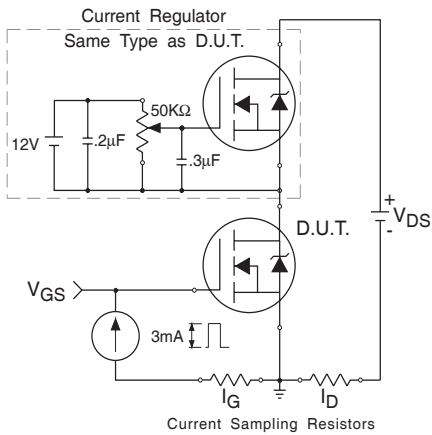

Fig 16a. Gate Charge Test Circuit

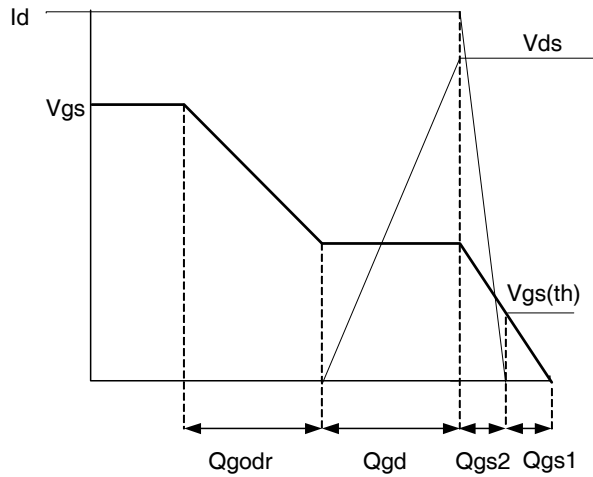
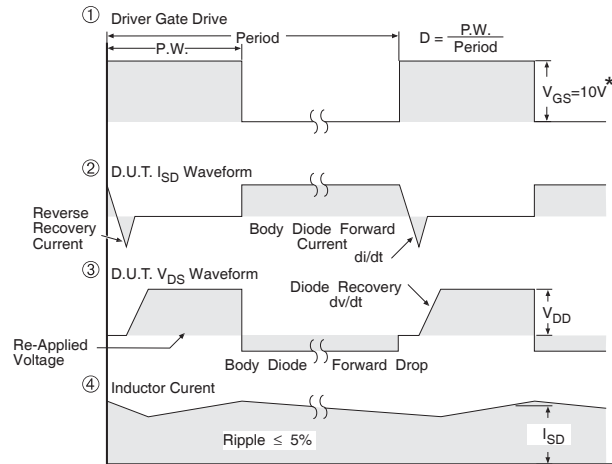
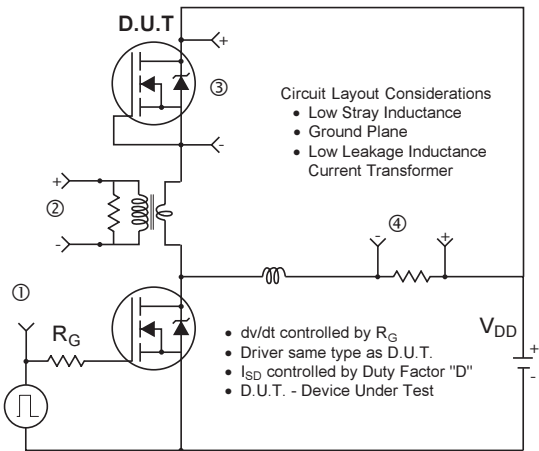

Fig 16b. Gate Charge Waveform



* $V_{GS} = 5V$ for Logic Level Devices

Fig 17. Peak Diode Recovery dv/dt Test Circuit for N-Channel HEXFET® Power MOSFETs

IRF8721PbF

International
IR Rectifier

SO-8 Package Outline

Dimensions are shown in millimeters (inches)

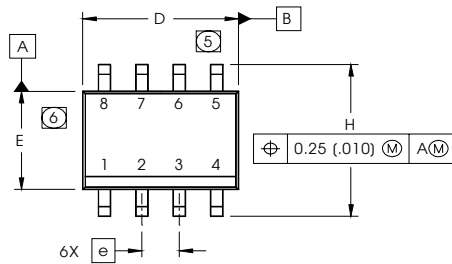

DIM	INCHES		MILLIMETERS	
	MIN	MAX	MIN	MAX
A	.0532	.0688	1.35	1.75
A1	.0040	.0098	0.10	0.25
b	.013	.020	0.33	0.51
c	.0075	.0098	0.19	0.25
D	.189	.1968	4.80	5.00
E	.1497	.1574	3.80	4.00
e	.050 BASIC		1.27 BASIC	
e1	.025 BASIC		0.635 BASIC	
H	.2284	.2440	5.80	6.20
K	.0099	.0196	0.25	0.50
L	.016	.050	0.40	1.27
y	0°	8°	0°	8°

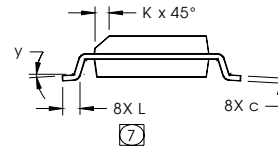
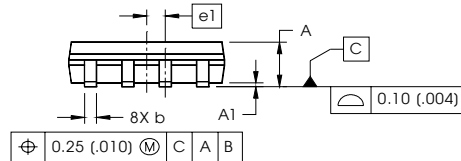

FOOTPRINT

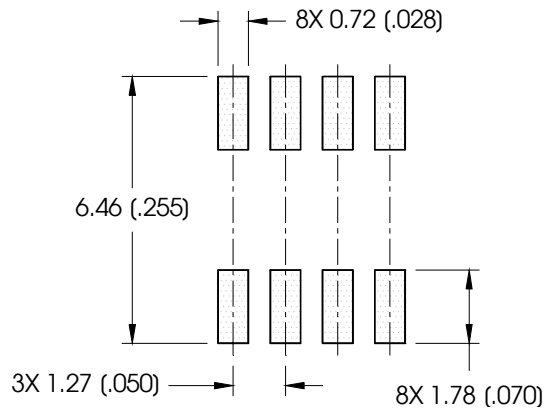

NOTES:

1. DIMENSIONING & TOLERANCING PER ASME Y14.5M-1994.
2. CONTROLLING DIMENSION: MILLIMETER
3. DIMENSIONS ARE SHOWN IN MILLIMETERS (INCHES).
4. OUTLINE CONFORMS TO JEDEC OUTLINE MS-012AA.
- ⑤ DIMENSION DOES NOT INCLUDE MOLD PROTRUSIONS. MOLD PROTRUSIONS NOT TO EXCEED 0.15 (.006).
- ⑥ DIMENSION DOES NOT INCLUDE MOLD PROTRUSIONS. MOLD PROTRUSIONS NOT TO EXCEED 0.25 (.010).
- ⑦ DIMENSION IS THE LENGTH OF LEAD FOR SOLDERING TO A SUBSTRATE.

SO-8 Part Marking Information

EXAMPLE: THIS IS AN IRF7101 (MOSFET)

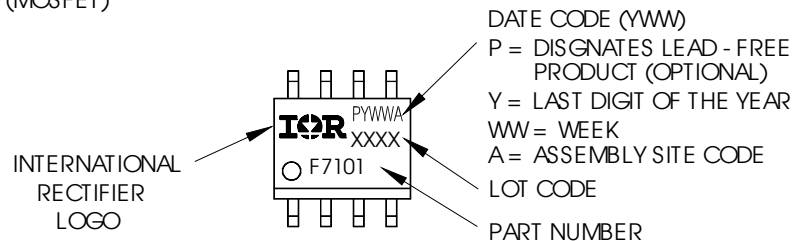

Note: For the most current drawing please refer to IR website at <http://www.irf.com/package/>

SO-8 Tape and Reel

Dimensions are shown in millimeters (inches)

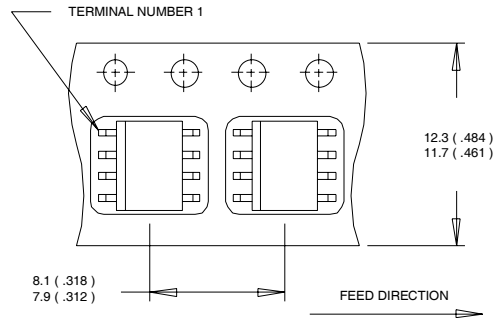

- NOTES:
1. CONTROLLING DIMENSION : MILLIMETER.
 2. ALL DIMENSIONS ARE SHOWN IN MILLIMETERS(INCHES).
 3. OUTLINE CONFORMS TO EIA-481 & EIA-541.

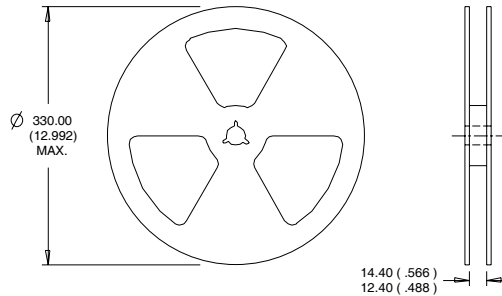

- NOTES:
1. CONTROLLING DIMENSION : MILLIMETER.
 2. OUTLINE CONFORMS TO EIA-481 & EIA-541.

Note: For the most current drawing please refer to IR website at <http://www.irf.com/package/>

Notes:

- ① Repetitive rating; pulse width limited by max. junction temperature.
- ② Starting $T_J = 25^\circ\text{C}$, $L = 1.09\text{mH}$, $R_G = 25\Omega$, $I_{AS} = 11\text{A}$.
- ③ Pulse width $\leq 400\mu\text{s}$; duty cycle $\leq 2\%$.
- ④ When mounted on 1 inch square copper board.
- ⑤ R_{θ} is measured at T_J of approximately 90°C .

Data and specifications subject to change without notice.
 This product has been designed and qualified for the Consumer market.
 Qualification Standards can be found on IR's Web site.

IMPORTANT NOTICE

The information given in this document shall in no event be regarded as a guarantee of conditions or characteristics ("Beschaffheitsgarantie").

With respect to any examples, hints or any typical values stated herein and/or any information regarding the application of the product, Infineon Technologies hereby disclaims any and all warranties and liabilities of any kind, including without limitation warranties of non-infringement of intellectual property rights of any third party.

In addition, any information given in this document is subject to customer's compliance with its obligations stated in this document and any applicable legal requirements, norms and standards concerning customer's products and any use of the product of Infineon Technologies in customer's applications.

The data contained in this document is exclusively intended for technically trained staff. It is the responsibility of customer's technical departments to evaluate the suitability of the product for the intended application and the completeness of the product information given in this document with respect to such application.

For further information on the product, technology, delivery terms and conditions and prices please contact your nearest Infineon Technologies office (www.infineon.com).

WARNINGS

Due to technical requirements products may contain dangerous substances. For information on the types in question please contact your nearest Infineon Technologies office.

Except as otherwise explicitly approved by Infineon Technologies in a written document signed by authorized representatives of Infineon Technologies, Infineon Technologies' products may not be used in any applications where a failure of the product or any consequences of the use thereof can reasonably be expected to result in personal injury.

X-ON Electronics

Largest Supplier of Electrical and Electronic Components

Click to view similar products for [MOSFET](#) category:

Click to view products by [Infineon](#) manufacturer:

Other Similar products are found below :

[614233C](#) [648584F](#) [IRFD120](#) [JANTX2N5237](#) [FCA20N60_F109](#) [FDZ595PZ](#) [2SK2545\(Q,T\)](#) [405094E](#) [423220D](#) [TPCC8103,L1Q\(CM](#)
[MIC4420CM-TR](#) [VN1206L](#) [SBVS138LT1G](#) [614234A](#) [715780A](#) [NTNS3166NZT5G](#) [SSM6J414TU,LF\(T](#) [751625C](#) [BUK954R8-60E](#)
[NTE6400](#) [SQJ402EP-T1-GE3](#) [2SK2614\(TE16L1,Q\)](#) [2N7002KW-FAI](#) [DMN1017UCP3-7](#) [EFC2J004NUZTDG](#) [ECH8691-TL-W](#)
[FCAB21350L1](#) [P85W28HP2F-7071](#) [DMN1053UCP4-7](#) [NTE221](#) [NTE222](#) [NTE2384](#) [NTE2903](#) [NTE2941](#) [NTE2945](#) [NTE2946](#) [NTE2960](#)
[NTE2967](#) [NTE2969](#) [NTE2976](#) [NTE455](#) [NTE6400A](#) [NTE2910](#) [NTE2916](#) [NTE2956](#) [NTE2911](#) [DMN2080UCB4-7](#) [TK10A80W,S4X\(S](#)
[SSM6P69NU,LF](#) [DMP22D4UFO-7B](#)