

Features

- Key Parameters Optimized for Class-D Audio Amplifier Applications
- Low $R_{DS(ON)}$ for Improved Efficiency
- Low Q_G and Q_{SW} for Better THD and Improved Efficiency
- Low Q_{RR} for Better THD and Lower EMI
- 175°C Operating Junction Temperature for Ruggedness
- Can Deliver up to 300W per Channel into 4Ω Load in Half-Bridge Configuration Amplifier

Key Parameters		
V_{DS}	150	V
$R_{DS(ON)}$ typ. @ 10V	32	mΩ
Q_g typ.	26	nC
Q_{sw} typ.	11	nC
$R_{G(int)}$ typ.	2.7	Ω
T_J max	175	°C

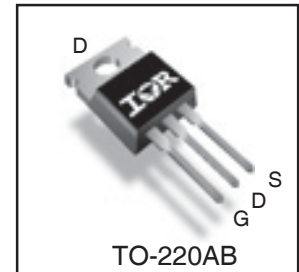
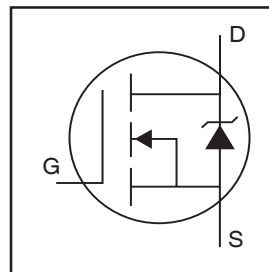

G	D	S
Gate	Drain	Source

Description

This Digital Audio MOSFET is specifically designed for Class-D audio amplifier applications. This MOSFET utilizes the latest processing techniques to achieve low on-resistance per silicon area. Furthermore, Gate charge, body-diode reverse recovery and internal Gate resistance are optimized to improve key Class-D audio amplifier performance factors such as efficiency, THD and EMI. Additional features of this MOSFET are 175°C operating junction temperature and repetitive avalanche capability. These features combine to make this MOSFET a highly efficient, robust and reliable device for ClassD audio amplifier applications.

Absolute Maximum Ratings

	Parameter	Max.	Units
V_{DS}	Drain-to-Source Voltage	150	V
V_{GS}	Gate-to-Source Voltage	±20	
I_D @ $T_C = 25^\circ\text{C}$	Continuous Drain Current, V_{GS} @ 10V	35	A
I_D @ $T_C = 100^\circ\text{C}$	Continuous Drain Current, V_{GS} @ 10V	25	
I_{DM}	Pulsed Drain Current ①	140	
P_D @ $T_C = 25^\circ\text{C}$	Power Dissipation ④	144	W
P_D @ $T_C = 100^\circ\text{C}$	Power Dissipation ④	72	
	Linear Derating Factor	0.96	W/°C
T_J	Operating Junction and Storage Temperature Range	-55 to + 175	°C
T_{STG}			
	Soldering Temperature, for 10 seconds (1.6mm from case)	300	
	Mounting torque, 6-32 or M3 screw	10lb·in (1.1N·m)	

Thermal Resistance

	Parameter	Typ.	Max.	Units
$R_{\theta JC}$	Junction-to-Case ④	—	1.045	°C/W
$R_{\theta CS}$	Case-to-Sink, Flat, Greased Surface	0.50	—	
$R_{\theta JA}$	Junction-to-Ambient ④	—	62	

Notes ① through ⑤ are on page 2

Electrical Characteristics @ $T_J = 25^\circ\text{C}$ (unless otherwise specified)

	Parameter	Min.	Typ.	Max.	Units	Conditions
BV_{DSS}	Drain-to-Source Breakdown Voltage	150	—	—	V	$V_{GS} = 0V, I_D = 250\mu A$
$\Delta BV_{DSS}/\Delta T_J$	Breakdown Voltage Temp. Coefficient	—	0.18	—	V/°C	Reference to $25^\circ\text{C}, I_D = 1\text{mA}$
$R_{DS(on)}$	Static Drain-to-Source On-Resistance	—	32	39	mΩ	$V_{GS} = 10V, I_D = 21A$ ③
$V_{GS(th)}$	Gate Threshold Voltage	3.0	—	5.0	V	$V_{DS} = V_{GS}, I_D = 100\mu A$
$\Delta V_{GS(th)}/\Delta T_J$	Gate Threshold Voltage Coefficient	—	-13	—	mV/°C	
I_{DSS}	Drain-to-Source Leakage Current	—	—	20	μA	$V_{DS} = 150V, V_{GS} = 0V$
		—	—	250		$V_{DS} = 150V, V_{GS} = 0V, T_J = 125^\circ\text{C}$
I_{GSS}	Gate-to-Source Forward Leakage	—	—	100	nA	$V_{GS} = 20V$
	Gate-to-Source Reverse Leakage	—	—	-100		$V_{GS} = -20V$
g_{fs}	Forward Transconductance	35	—	—	S	$V_{DS} = 50V, I_D = 21A$
Q_g	Total Gate Charge	—	26	40	nC	$V_{DS} = 75V$ $V_{GS} = 10V$ $I_D = 21A$ See Fig. 6 and 19
Q_{gs1}	Pre-Vth Gate-to-Source Charge	—	6.4	—		
Q_{gs2}	Post-Vth Gate-to-Source Charge	—	2.2	—		
Q_{gd}	Gate-to-Drain Charge	—	9.0	—		
Q_{godr}	Gate Charge Overdrive	—	8.9	—		
Q_{sw}	Switch Charge ($Q_{gs2} + Q_{gd}$)	—	11	—		
$R_{G(int)}$	Internal Gate Resistance	—	2.7	5.0	Ω	
$t_{d(on)}$	Turn-On Delay Time	—	8.9	—	ns	$V_{DD} = 75V, V_{GS} = 10V$ ③ $I_D = 21A$ $R_G = 2.4\Omega$
t_r	Rise Time	—	23.1	—		
$t_{d(off)}$	Turn-Off Delay Time	—	17.2	—		
t_f	Fall Time	—	13.1	—		
C_{iss}	Input Capacitance	—	1750	—	pF	$V_{GS} = 0V$ $V_{DS} = 50V$ $f = 1.0\text{MHz}$, See Fig.5 $V_{GS} = 0V, V_{DS} = 0V$ to $120V$
C_{oss}	Output Capacitance	—	155	—		
C_{rss}	Reverse Transfer Capacitance	—	40	—		
C_{oss}	Effective Output Capacitance	—	175	—		
L_D	Internal Drain Inductance	—	4.5	—	nH	Between lead, 6mm (0.25in.) from package and center of die contact
L_S	Internal Source Inductance	—	7.5	—		

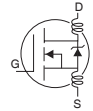

Avalanche Characteristics

	Parameter	Typ.	Max.	Units
E_{AS}	Single Pulse Avalanche Energy ②	—	109	mJ
I_{AR}	Avalanche Current ⑤	See Fig. 14, 15, 17a, 17b		A
E_{AR}	Repetitive Avalanche Energy ⑤			mJ

Diode Characteristics

	Parameter	Min.	Typ.	Max.	Units	Conditions
$I_S @ T_C = 25^\circ\text{C}$	Continuous Source Current (Body Diode)	—	—	35	A	MOSFET symbol showing the integral reverse p-n junction diode.
I_{SM}	Pulsed Source Current (Body Diode) ①	—	—	140		
V_{SD}	Diode Forward Voltage	—	—	1.3	V	$T_J = 25^\circ\text{C}, I_S = 21A, V_{GS} = 0V$ ③
t_{rr}	Reverse Recovery Time	—	80	120	ns	$T_J = 25^\circ\text{C}, I_F = 21A, V_R = 120V$
Q_{rr}	Reverse Recovery Charge	—	312	468	nC	$di/dt = 100A/\mu s$ ③

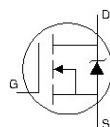

Notes:

- ① Repetitive rating; pulse width limited by max. junction temperature. ④ R_{θ} is measured at T_J of approximately 90°C .
 ② Starting $T_J = 25^\circ\text{C}$, $L = 0.51\text{mH}$, $R_G = 25\Omega$, $I_{AS} = 21A$. ⑤ Limited by T_{jmax} . See Figs. 14, 15, 17a, 17b for repetitive avalanche information
 ③ Pulse width $\leq 400\mu s$; duty cycle $\leq 2\%$.

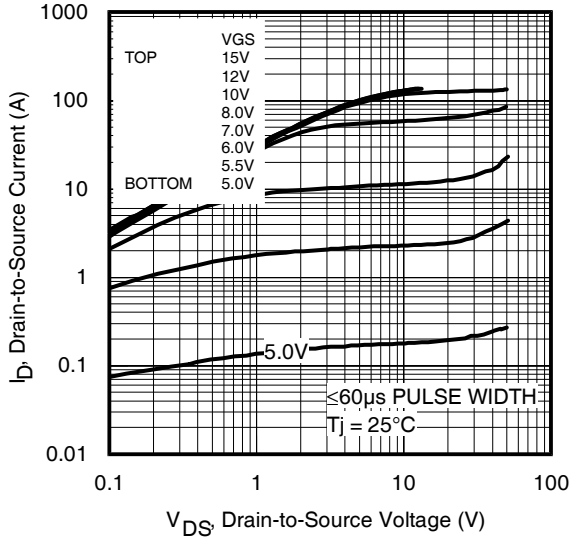

Fig 1. Typical Output Characteristics

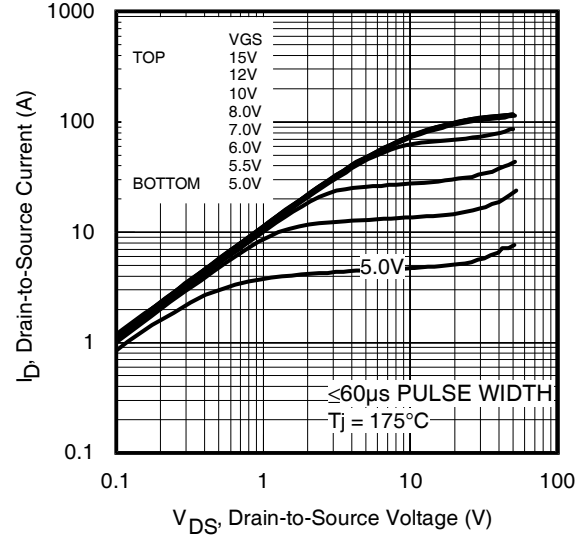

Fig 2. Typical Output Characteristics

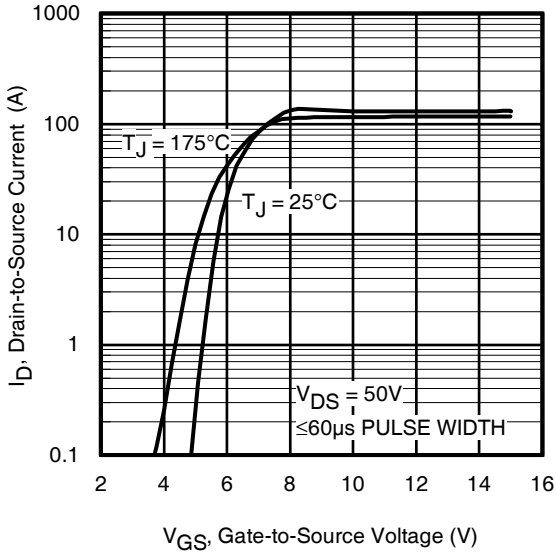

Fig 3. Typical Transfer Characteristics

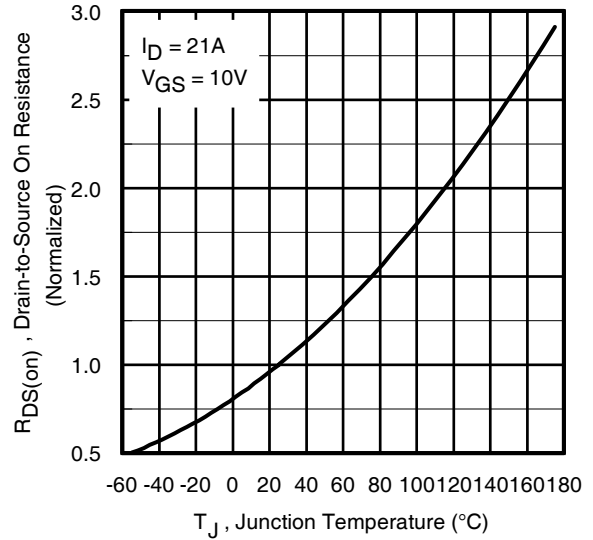

Fig 4. Normalized On-Resistance vs. Temperature

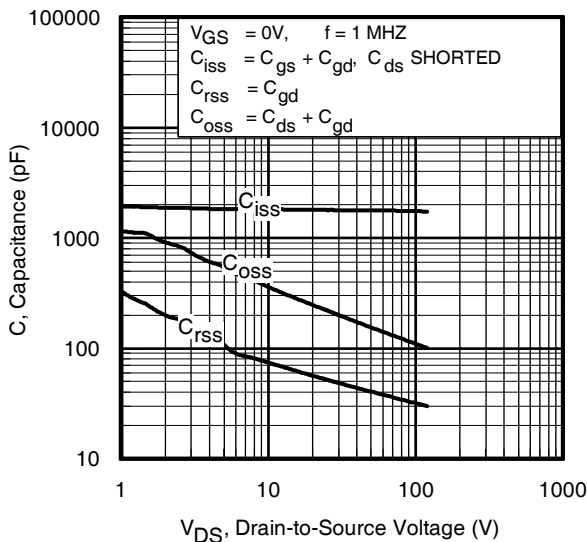

Fig 5. Typical Capacitance vs. Drain-to-Source Voltage
www.irf.com

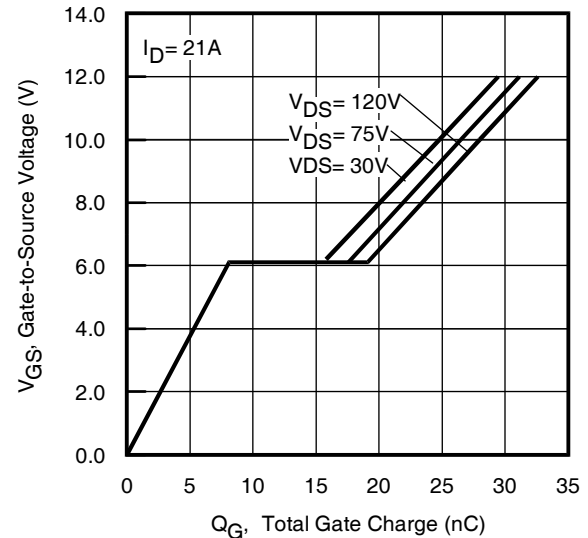

Fig 6. Typical Gate Charge vs. Gate-to-Source Voltage

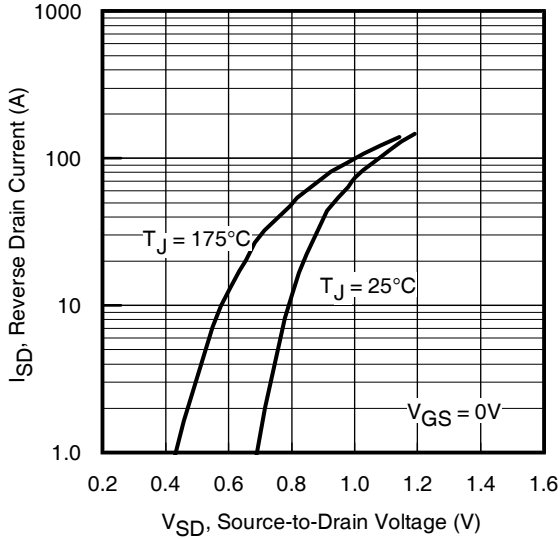

Fig 7. Typical Source-Drain Diode Forward Voltage

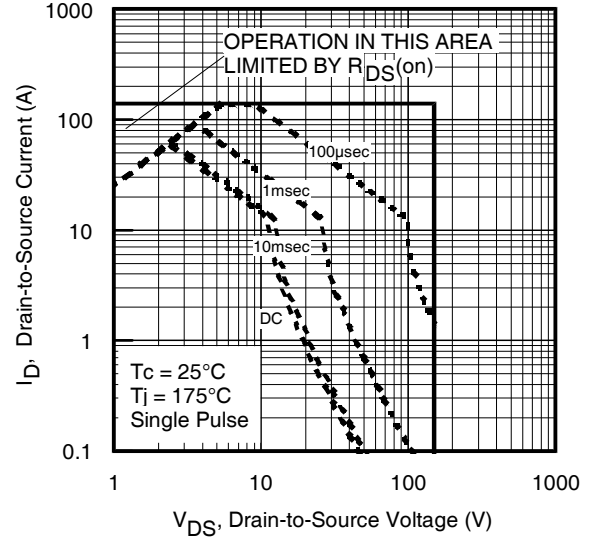

Fig 8. Maximum Safe Operating Area

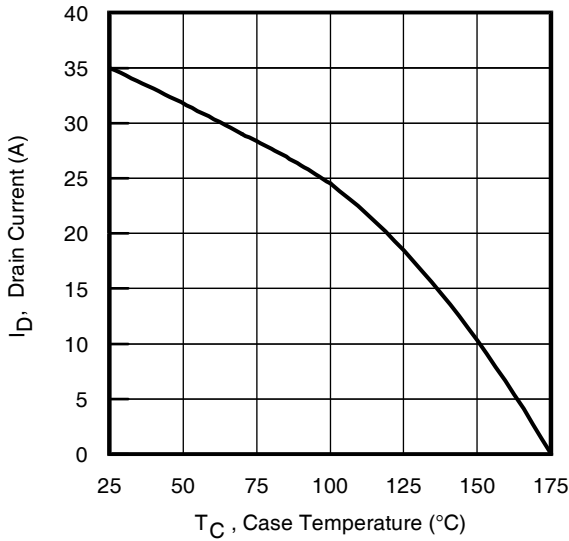

Fig 9. Maximum Drain Current vs. Case Temperature

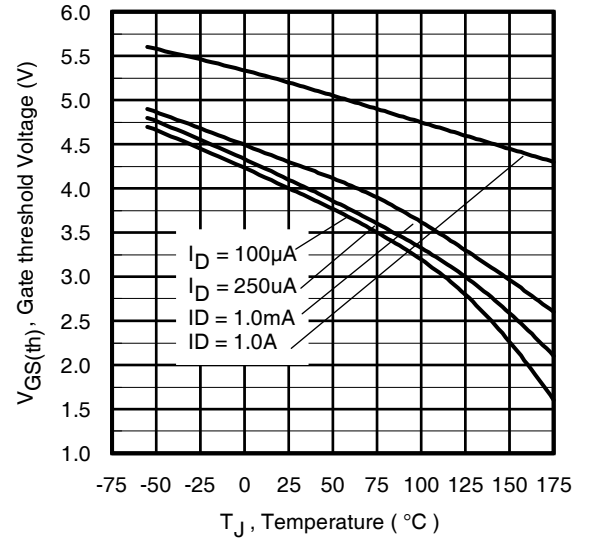

Fig 10. Threshold Voltage vs. Temperature

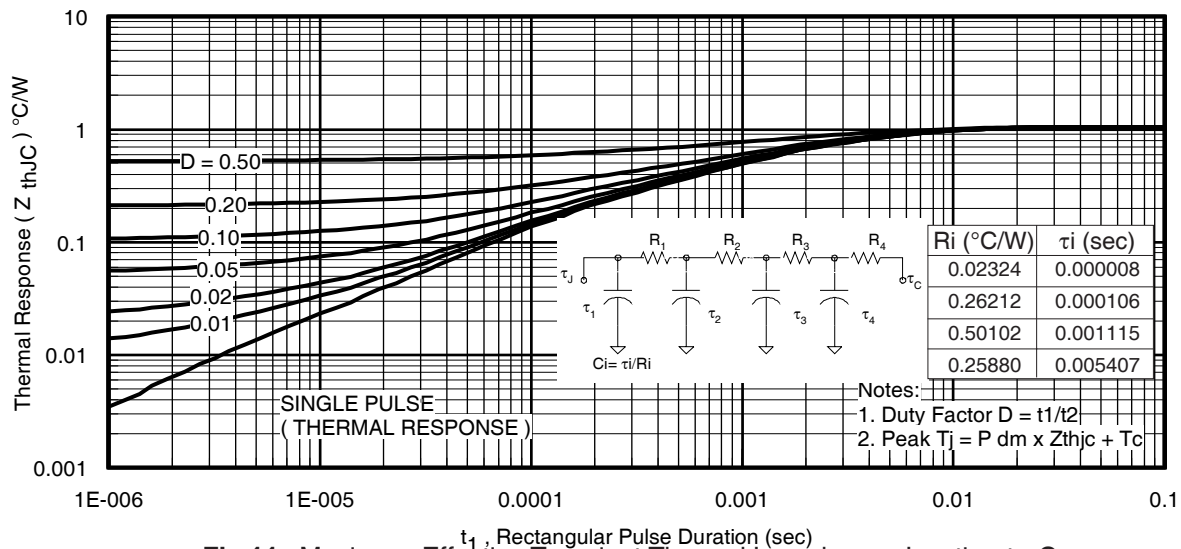

Fig 11. Maximum Effective Transient Thermal Impedance, Junction-to-Case

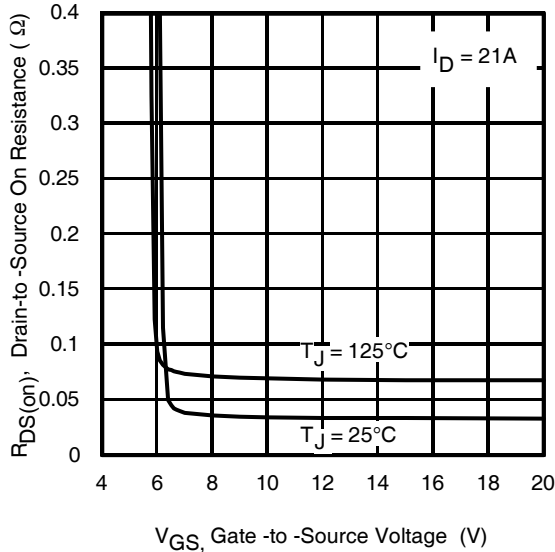

Fig 12. On-Resistance Vs. Gate Voltage

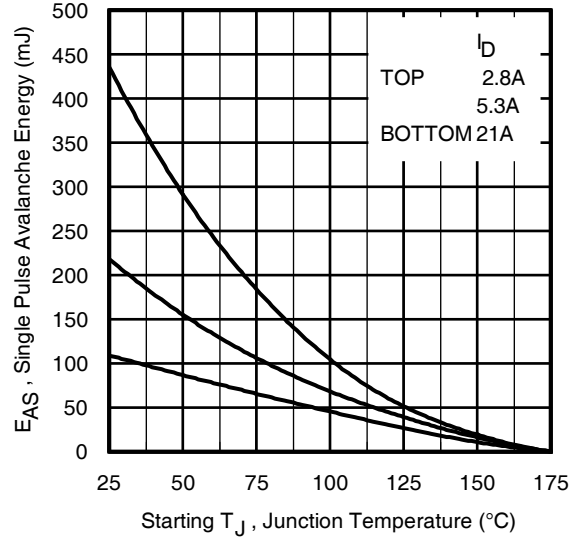

Fig 13. Maximum Avalanche Energy Vs. Drain Current

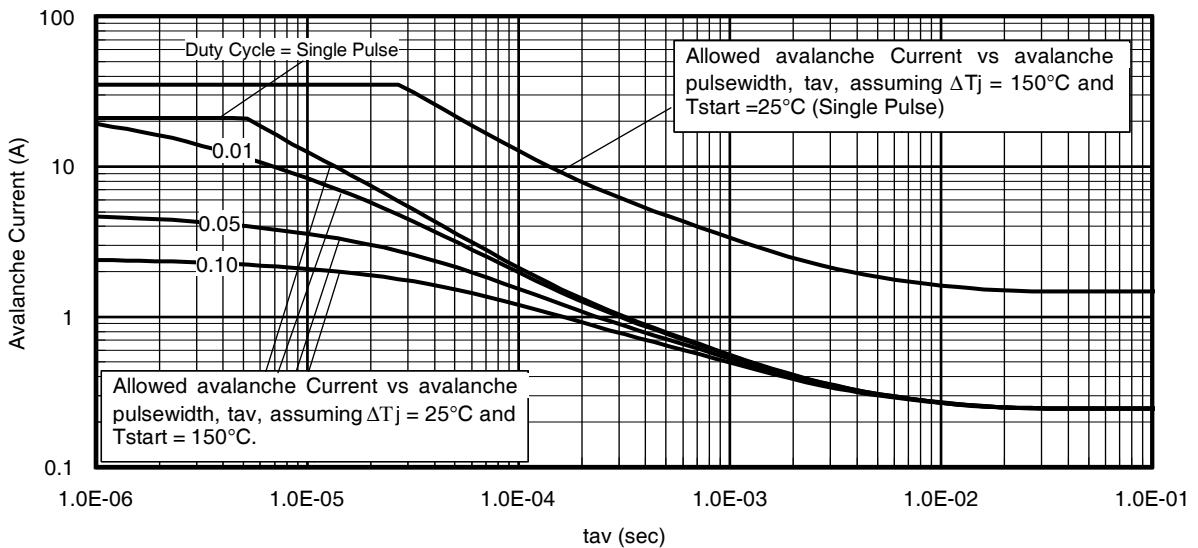

Fig 14. Typical Avalanche Current Vs. Pulsewidth

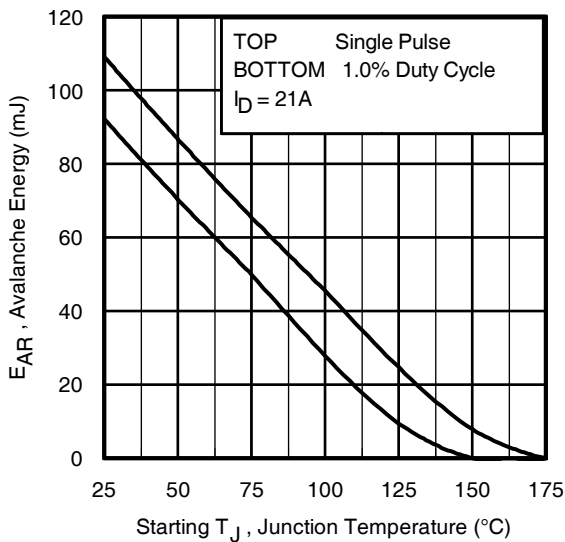

Fig 15. Maximum Avalanche Energy Vs. Temperature

Notes on Repetitive Avalanche Curves, Figures 14, 15:
(For further info, see AN-1005 at www.irf.com)

1. Avalanche failures assumption:
Purely a thermal phenomenon and failure occurs at a temperature far in excess of T_{jmax} . This is validated for every part type.
2. Safe operation in Avalanche is allowed as long as neither T_{jmax} nor I_{av} (max) is exceeded
3. Equation below based on circuit and waveforms shown in Figures 17a, 17b.
4. $P_{D(ave)}$ = Average power dissipation per single avalanche pulse.
5. B_V = Rated breakdown voltage (1.3 factor accounts for voltage increase during avalanche).
6. I_{av} = Allowable avalanche current.
7. ΔT = Allowable rise in junction temperature, not to exceed T_{jmax} (assumed as 25°C in Figure 14, 15).
 t_{av} = Average time in avalanche.
 D = Duty cycle in avalanche = $t_{av} \cdot f$
 $Z_{thJC}(D, t_{av})$ = Transient thermal resistance, see figure 11)

$$P_{D(ave)} = 1/2 (1.3 \cdot B_V \cdot I_{av}) = \Delta T / Z_{thJC}$$

$$I_{av} = 2\Delta T / [1.3 \cdot B_V \cdot Z_{th}]$$

$$E_{AS(AR)} = P_{D(ave)} \cdot t_{av}$$

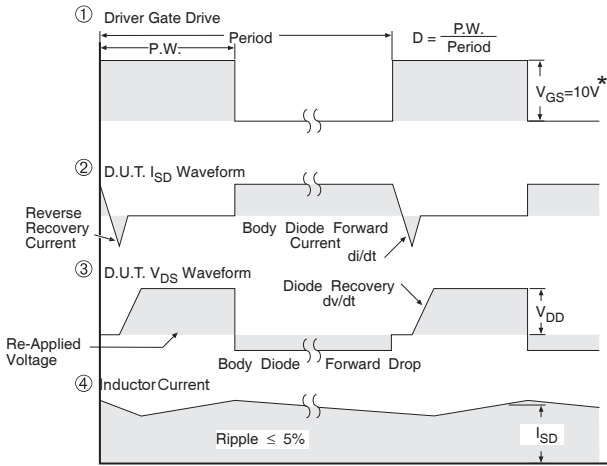
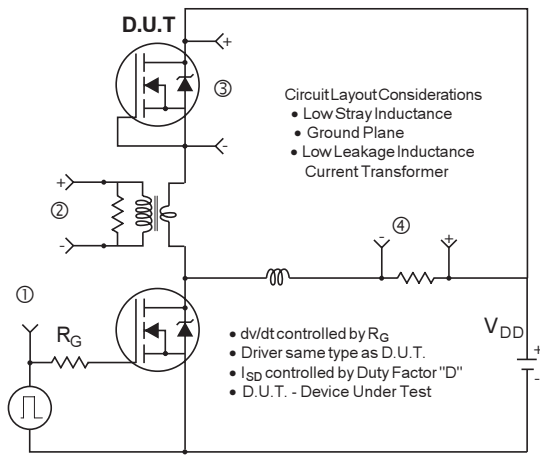

* $V_{GS} = 5V$ for Logic Level Devices

Fig 16. Peak Diode Recovery dv/dt Test Circuit for N-Channel HEXFET® Power MOSFETs

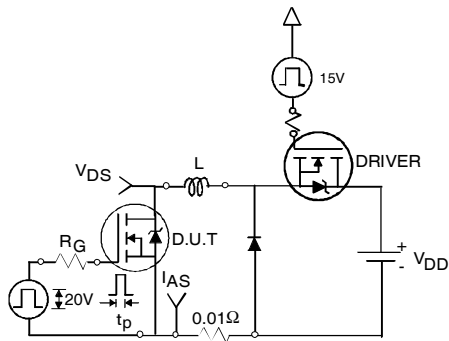

Fig 17a. Unclamped Inductive Test Circuit

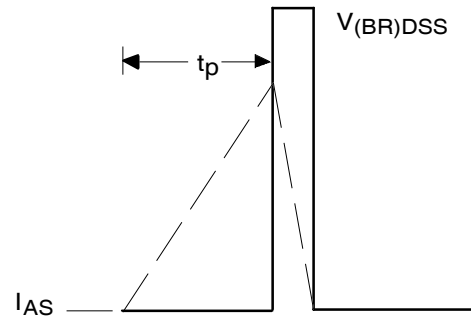

Fig 17b. Unclamped Inductive Waveforms

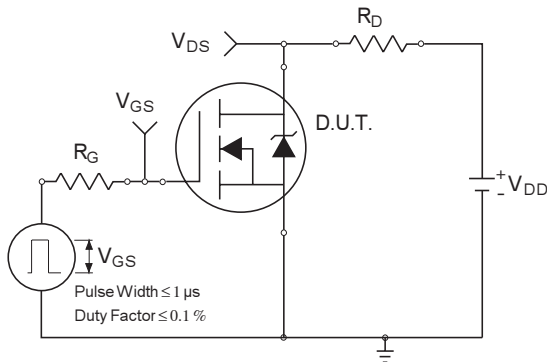

Fig 18a. Switching Time Test Circuit

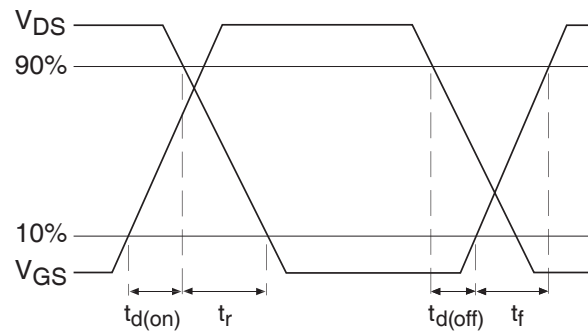

Fig 18b. Switching Time Waveforms

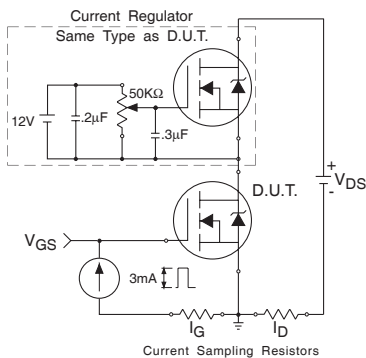

Fig 19a. Gate Charge Test Circuit

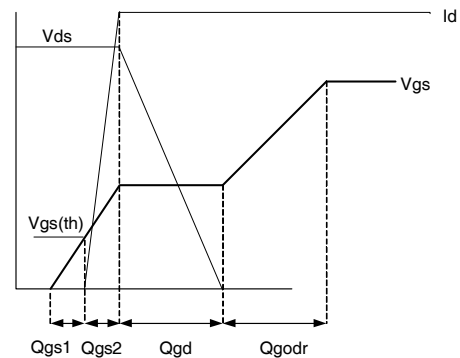
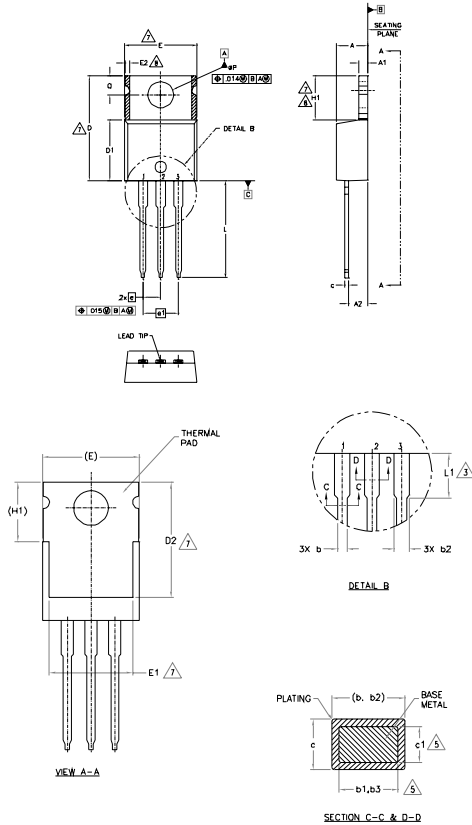

Fig 19b. Gate Charge Waveform

TO-220AB Package Outline

Dimensions are shown in millimeters (inches)



NOTES:

- 1.- DIMENSIONING AND TOLERANCING AS PER ASME Y14.5 M- 1994.
- 2.- DIMENSIONS ARE SHOWN IN INCHES [MILLIMETERS]
- 3.- LEAD DIMENSION AND FINISH UNCONTROLLED IN L1
- 4.- DIMENSION D, D1 & E DO NOT INCLUDE MOLD FLASH. MOLD FLASH SHALL NOT EXCEED .005" (0.127) PER SIDE. THESE DIMENSIONS ARE MEASURED AT THE OUTERMOST EXTREMES OF THE PLASTIC BODY.
- 5.- DIMENSION b1, b3 & c1 APPLY TO BASE METAL ONLY.
- 6.- CONTROLLING DIMENSION - INCHES.
- 7.- THERMAL PAD CONTOUR OPTIONAL WITHIN DIMENSIONS E.H1,D2 & E1
- 8.- DIMENSION E2 X H1 DEFINE A ZONE WHERE STAMPING AND SINGULATION IRREGULARITIES ARE ALLOWED.
- 9.- OUTLINE CONFORMS TO JEDEC TO-220, EXCEPT A2 (max.) AND D2 (min.) WHERE DIMENSIONS ARE DERIVED FROM THE ACTUAL PACKAGE OUTLINE.

SYMBOL	DIMENSIONS				NOTES
	MILLIMETERS		INCHES		
	MIN.	MAX.	MIN.	MAX.	
A	3.56	4.83	.140	.190	
A1	0.51	1.40	.020	.055	
A2	2.03	2.92	.080	.115	
b	0.38	1.01	.015	.040	5
b1	0.38	0.97	.015	.038	
b2	1.14	1.78	.045	.070	
b3	1.14	1.73	.045	.068	5
c	0.36	0.61	.014	.024	
c1	0.36	0.56	.014	.022	5
D	14.22	18.51	.560	.750	4
D1	8.38	9.02	.330	.355	
D2	11.68	12.88	.460	.507	7
E	9.85	10.67	.380	.420	4,7
E1	6.86	8.89	.270	.350	7
E2	-	0.76	-	.030	8
e	2.54 BSC		.100 BSC		
e1	5.08 BSC		.200 BSC		
H1	5.84	6.86	.230	.270	7,8
L	12.70	14.73	.500	.580	
L1	3.56	4.06	.140	.160	3
pP	3.54	4.08	.139	.161	
Q	2.54	3.42	.100	.135	

LEAD ASSIGNMENTS

- HEFET**
1- GATE
2- DRAIN
3- SOURCE
- IRBL CoPACs**
1- GATE
2- COLLECTOR
3- EMITTER
- DIODES**
1- ANODE
2- CATHODE
3- ANODE

TO-220AB Part Marking Information

EXAMPLE: THIS IS AN IRF1010
LOT CODE 1789
ASSEMBLED ON WW 19, 2000
IN THE ASSEMBLY LINE "C"

Note: "P" in assembly line position indicates "Lead - Free"

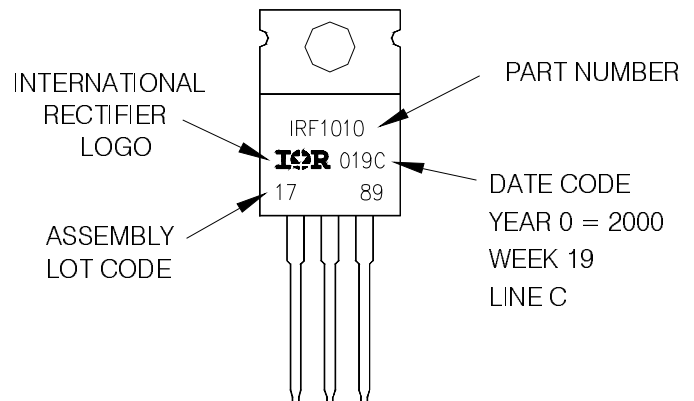

TO-220AB packages are not recommended for Surface Mount Application.

Note: For the most current drawing please refer to IR website at <http://www.irf.com/package/>

Data and specifications subject to change without notice.
This product has been designed and qualified for the Industrial market.
Qualification Standards can be found on IR's Web site.

IMPORTANT NOTICE

The information given in this document shall in no event be regarded as a guarantee of conditions or characteristics ("Beschaffheitsgarantie").

With respect to any examples, hints or any typical values stated herein and/or any information regarding the application of the product, Infineon Technologies hereby disclaims any and all warranties and liabilities of any kind, including without limitation warranties of non-infringement of intellectual property rights of any third party.

In addition, any information given in this document is subject to customer's compliance with its obligations stated in this document and any applicable legal requirements, norms and standards concerning customer's products and any use of the product of Infineon Technologies in customer's applications.

The data contained in this document is exclusively intended for technically trained staff. It is the responsibility of customer's technical departments to evaluate the suitability of the product for the intended application and the completeness of the product information given in this document with respect to such application.

For further information on the product, technology, delivery terms and conditions and prices please contact your nearest Infineon Technologies office (www.infineon.com).

WARNINGS

Due to technical requirements products may contain dangerous substances. For information on the types in question please contact your nearest Infineon Technologies office.

Except as otherwise explicitly approved by Infineon Technologies in a written document signed by authorized representatives of Infineon Technologies, Infineon Technologies' products may not be used in any applications where a failure of the product or any consequences of the use thereof can reasonably be expected to result in personal injury.

X-ON Electronics

Largest Supplier of Electrical and Electronic Components

Click to view similar products for [MOSFET](#) category:

Click to view products by [Infineon](#) manufacturer:

Other Similar products are found below :

[614233C](#) [648584F](#) [IRFD120](#) [JANTX2N5237](#) [FCA20N60_F109](#) [FDZ595PZ](#) [2SK2545\(Q,T\)](#) [405094E](#) [423220D](#) [TPCC8103,L1Q\(CM](#)
[MIC4420CM-TR](#) [VN1206L](#) [614234A](#) [715780A](#) [NTNS3166NZT5G](#) [SSM6J414TU,LF\(T](#) [751625C](#) [BUK954R8-60E](#) [GROUP A 5962-](#)
[8877003PA](#) [NTE6400](#) [SQJ402EP-T1-GE3](#) [2SK2614\(TE16L1,Q\)](#) [2N7002KW-FAI](#) [DMN1017UCP3-7](#) [EFC2J004NUZTDG](#) [ECH8691-TL-W](#)
[FCAB21350L1](#) [P85W28HP2F-7071](#) [DMN1053UCP4-7](#) [NTE221](#) [NTE222](#) [NTE2384](#) [NTE2903](#) [NTE2941](#) [NTE2945](#) [NTE2946](#) [NTE2960](#)
[NTE2967](#) [NTE2969](#) [NTE2976](#) [NTE6400A](#) [NTE2910](#) [NTE2916](#) [NTE2956](#) [NTE2911](#) [DMN2080UCB4-7](#) [TK10A80W,S4X\(S](#)
[SSM6P69NU,LF](#) [DMP22D4UFO-7B](#) [DMN1006UCA6-7](#)