

HEXFET® Power MOSFET

	Q1	Q2	
$V_{DSS}$	25	25	V
$R_{DS(on) max}$ (@ $V_{GS} = 4.5V$ )	4.60	1.45	mΩ
$Qg$ (typical)	10	31	nC
$I_D$ (@ $T_C = 25^\circ C$ )	35 <sup>⑦</sup>	35 <sup>⑦</sup>	A

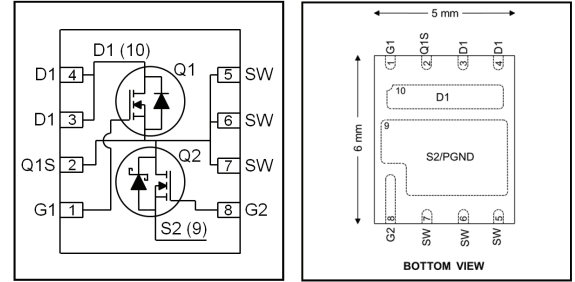

**Applications**

- Control and Synchronous MOSFETs for synchronous buck converters

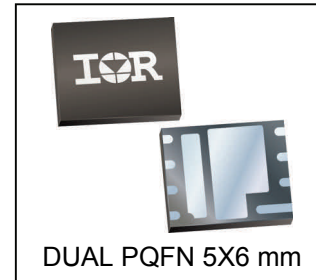

**Features**

Control and synchronous MOSFETs in one package
Low charge control MOSFET (10nC typical)
Low $R_{DS(on)}$ synchronous MOSFET (<1.45mΩ)
Intrinsic Schottky Diode with Low Forward Voltage on Q2
RoHS Compliant, Halogen-Free
MSL1, Industrial Qualification

results in



**Benefits**

Increased power density
Lower switching losses
Lower conduction losses
Lower Switching Losses
Environmentally friendlier
Increased reliability

Base part number	Package Type	Standard Pack		Orderable Part Number
		Form	Quantity	
IRFH4253DPbF	Dual PQFN 5mm x 6mm	Tape and Reel	4000	IRFH4253DTRPbF

**Absolute Maximum Ratings**

	Parameter	Q1 Max.	Q2 Max.	Units
$V_{GS}$	Gate-to-Source Voltage	± 20		V
$I_D @ T_C = 25^\circ C$	Continuous Drain Current, $V_{GS} @ 4.5V$	64 <sup>⑥⑦</sup>	145 <sup>⑥⑦</sup>	A
$I_D @ T_C = 70^\circ C$	Continuous Drain Current, $V_{GS} @ 4.5V$	51 <sup>⑥⑦</sup>	116 <sup>⑥⑦</sup>	
$I_D @ T_C = 25^\circ C$	Continuous Drain Current, $V_{GS} @ 4.5V$ (Source Bonding Technology Limited)	35 <sup>⑦</sup>	35 <sup>⑦</sup>	
$I_{DM}$	Pulsed Drain Current	120	580 <sup>⑧</sup>	
$P_D @ T_C = 25^\circ C$	Power Dissipation	31	50	W
$P_D @ T_C = 70^\circ C$	Power Dissipation	20	32	
	Linear Derating Factor	0.25	0.40	W/°C
$T_J$ $T_{STG}$	Operating Junction and Storage Temperature Range	-55 to + 150		°C

**Thermal Resistance**

	Parameter	Q1 Max.	Q2 Max.	Units
$R_{\theta JC}$ (Bottom)	Junction-to-Case ④	4.0	2.5	°C/W
$R_{\theta JC}$ (Top)	Junction-to-Case ④	20	13	
$R_{\theta JA}$	Junction-to-Ambient ⑤	34	38	
$R_{\theta JA} (<10s)$	Junction-to-Ambient ⑤	24	24	

Notes ① through ⑧ are on page 12

**Static @ T<sub>J</sub> = 25°C (unless otherwise specified)**

	Parameter		Min.	Typ.	Max.	Units	Conditions		
BV <sub>DSS</sub>	Drain-to-Source Breakdown Voltage	Q1	25	—	—	V	V <sub>GS</sub> = 0V, I <sub>D</sub> = 250μA		
		Q2	25	—	—		V <sub>GS</sub> = 0V, I <sub>D</sub> = 1.0mA		
ΔBV <sub>DSS</sub> /ΔT <sub>J</sub>	Breakdown Voltage Temp. Coefficient	Q1	—	22	—	mV/°C	Reference to 25°C, I <sub>D</sub> = 1.0mA		
		Q2	—	22	—		Reference to 25°C, I <sub>D</sub> = 10mA		
R <sub>DS(on)</sub>	Static Drain-to-Source On-Resistance	Q1	—	2.50	3.20	mΩ	V <sub>GS</sub> = 10V, I <sub>D</sub> = 30A ③		
		Q2	—	0.90	1.10		V <sub>GS</sub> = 10V, I <sub>D</sub> = 30A ③		
		Q1	—	3.70	4.60		V <sub>GS</sub> = 4.5V, I <sub>D</sub> = 30A ③		
		Q2	—	1.15	1.45		V <sub>GS</sub> = 4.5V, I <sub>D</sub> = 30A ③		
V <sub>GS(th)</sub>	Gate Threshold Voltage	Q1	1.1	1.6	2.1	V	Q1: V <sub>DS</sub> = V <sub>GS</sub> , I <sub>D</sub> = 35μA		
		Q2	1.1	1.6	2.1		Q2: V <sub>DS</sub> = V <sub>GS</sub> , I <sub>D</sub> = 100μA		
ΔV <sub>GS(th)</sub> /ΔT <sub>J</sub>	Gate Threshold Voltage Coefficient	Q1	—	-5.7	—	mV/°C	Q1: V <sub>DS</sub> = V <sub>GS</sub> , I <sub>D</sub> = 35μA		
		Q2	—	-8.9	—		Q2: V <sub>DS</sub> = V <sub>GS</sub> , I <sub>D</sub> = 100μA		
I <sub>DSS</sub>	Drain-to-Source Leakage Current	Q1	—	—	1.0	μA	V <sub>DS</sub> = 20V, V <sub>GS</sub> = 0V		
		Q2	—	—	250		V <sub>DS</sub> = 20V, V <sub>GS</sub> = 0V		
I <sub>GSS</sub>	Gate-to-Source Forward Leakage	Q1/Q2	—	—	100	nA	V <sub>GS</sub> = 20V		
	Gate-to-Source Reverse Leakage	Q1/Q2	—	—	-100		V <sub>GS</sub> = -20V		
g <sub>fs</sub>	Forward Transconductance	Q1	131	—	—	S	V <sub>DS</sub> = 10V, I <sub>D</sub> = 30A		
		Q2	164	—	—		V <sub>DS</sub> = 10V, I <sub>D</sub> = 30A		
Q <sub>g</sub>	Total Gate Charge	Q1	—	10	15	nC	Q1 V <sub>DS</sub> = 13V V <sub>GS</sub> = 4.5V, I <sub>D</sub> = 30A  Q2 V <sub>DS</sub> = 13V V <sub>GS</sub> = 4.5V, I <sub>D</sub> = 30A		
		Q2	—	31	47				
Q <sub>gs1</sub>	Pre-V <sub>th</sub> Gate-to-Source Charge	Q1	—	2.5	—				
		Q2	—	4.9	—				
Q <sub>gs2</sub>	Post-V <sub>th</sub> Gate-to-Source Charge	Q1	—	1.6	—				
		Q2	—	5.4	—				
Q <sub>gd</sub>	Gate-to-Drain Charge	Q1	—	3.8	—				
		Q2	—	12	—				
Q <sub>godr</sub>	Gate Charge Overdrive	Q1	—	2.1	—				
		Q2	—	8.7	—				
Q <sub>sw</sub>	Switch Charge (Q <sub>gs2</sub> + Q <sub>gd</sub> )	Q1	—	5.4	—				
		Q2	—	17.4	—				
Q <sub>oss</sub>	Output Charge	Q1	—	10	—	nC	V <sub>DS</sub> = 16V, V <sub>GS</sub> = 0V		
		Q2	—	31	—				
R <sub>G</sub>	Gate Resistance	Q1	—	2.4	—	Ω			
		Q2	—	1.1	—				
t <sub>d(on)</sub>	Turn-On Delay Time	Q1	—	10	—	ns	Q1 V <sub>DS</sub> = 13V V <sub>GS</sub> = 4.5V I <sub>D</sub> = 30A, R <sub>G</sub> = 1.8Ω  Q2 V <sub>DS</sub> = 13V V <sub>GS</sub> = 4.5V I <sub>D</sub> = 30A, R <sub>G</sub> = 1.8Ω		
		Q2	—	16	—				
t <sub>r</sub>	Rise Time	Q1	—	61	—				
		Q2	—	98	—				
t <sub>d(off)</sub>	Turn-Off Delay Time	Q1	—	13	—				
		Q2	—	26	—				
t <sub>f</sub>	Fall Time	Q1	—	15	—				
		Q2	—	65	—				
C <sub>iss</sub>	Input Capacitance	Q1	—	1314	—			pF	V <sub>GS</sub> = 0V V <sub>DS</sub> = 13V f = 1.0MHz
		Q2	—	3756	—				
C <sub>oss</sub>	Output Capacitance	Q1	—	365	—				
		Q2	—	1205	—				
C <sub>rss</sub>	Reverse Transfer Capacitance	Q1	—	92	—				
		Q2	—	286	—				

**Avalanche Characteristics**

	Parameter	Typ.	Q1 Max.	Q2 Max.	Units
$E_{AS}$	Single Pulse Avalanche Energy ②	—	61	568	mJ
$I_{AR}$	Avalanche Current ①	—	30	60	A

**Diode Characteristics**

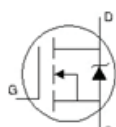
	Parameter		Min.	Typ.	Max.	Units	Conditions
$I_S$	Continuous Source Current (Body Diode)	Q1	—	—	35⑦	A	MOSFET symbol showing the integral reverse p-n junction diode. 
		Q2	—	—	35⑦		
$I_{SM}$	Pulsed Source Current (Body Diode)	Q1	—	—	120	A	
		Q2	—	—	580⑧		
$V_{SD}$	Diode Forward Voltage	Q1	—	—	1.0	V	$T_J = 25^\circ\text{C}$ , $I_S = 30\text{A}$ , $V_{GS} = 0\text{V}$ ③
		Q2	—	—	0.75		$T_J = 25^\circ\text{C}$ , $I_S = 30\text{A}$ , $V_{GS} = 0\text{V}$ ③
$t_{rr}$	Reverse Recovery Time	Q1	—	16	—	ns	$Q1$ $T_J = 25^\circ\text{C}$ , $I_F = 30\text{A}$ $V_{DD} = 13\text{V}$ , $di/dt = 235\text{A}/\mu\text{s}$ ③
		Q2	—	29	—		
$Q_{rr}$	Reverse Recovery Charge	Q1	—	13	—	nC	$Q2$ $T_J = 25^\circ\text{C}$ , $I_F = 30\text{A}$ $V_{DD} = 13\text{V}$ , $di/dt = 250\text{A}/\mu\text{s}$ ③
		Q2	—	41	—		

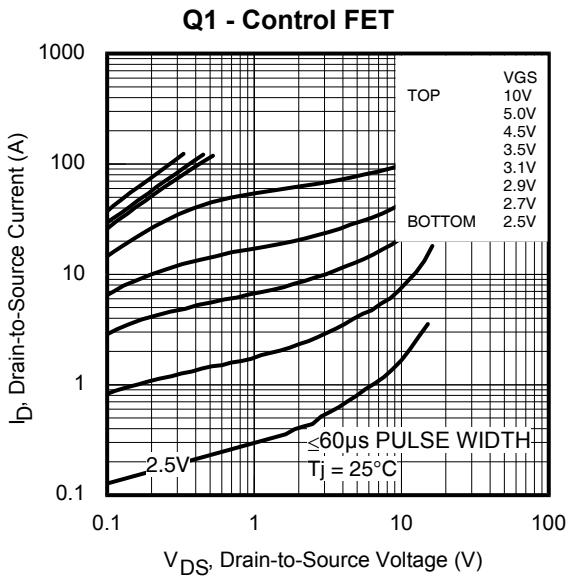
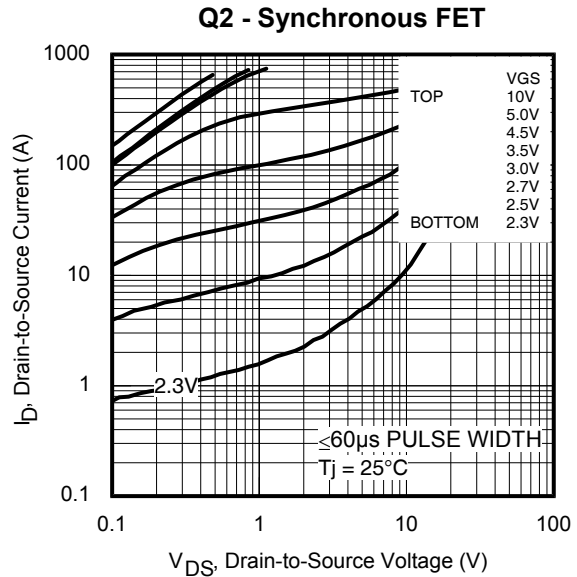
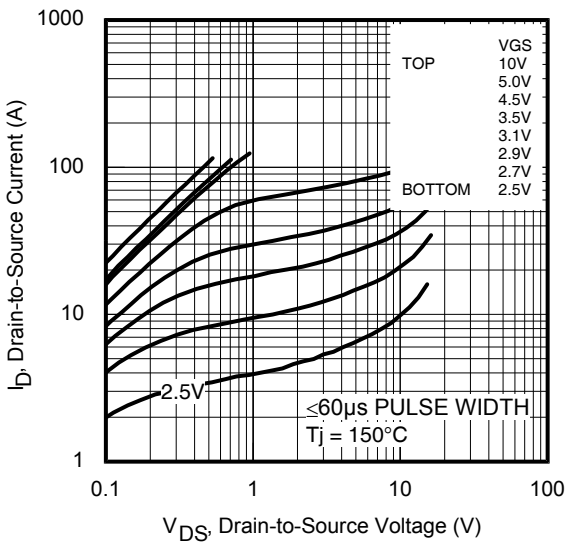
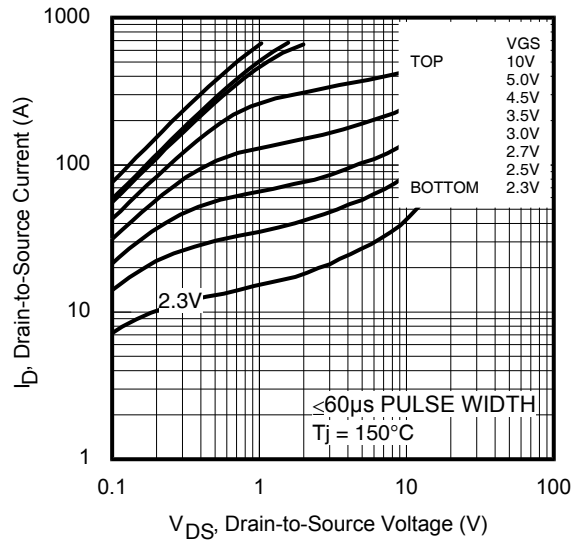
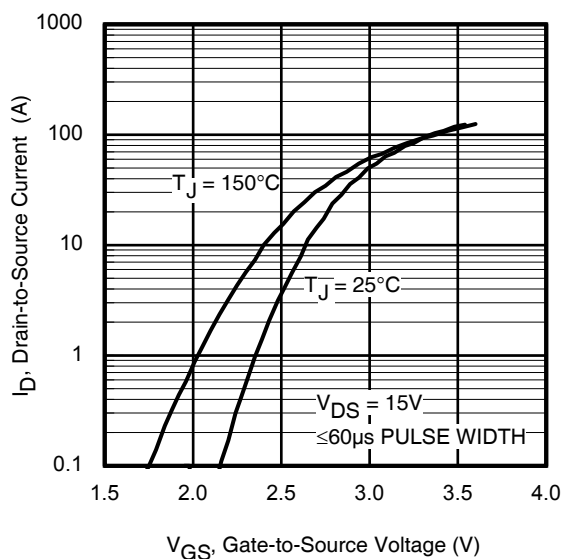
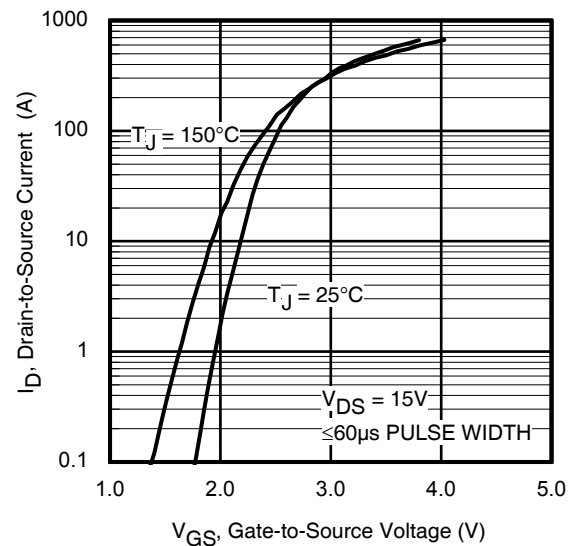
**Fig 1. Typical Output Characteristics**

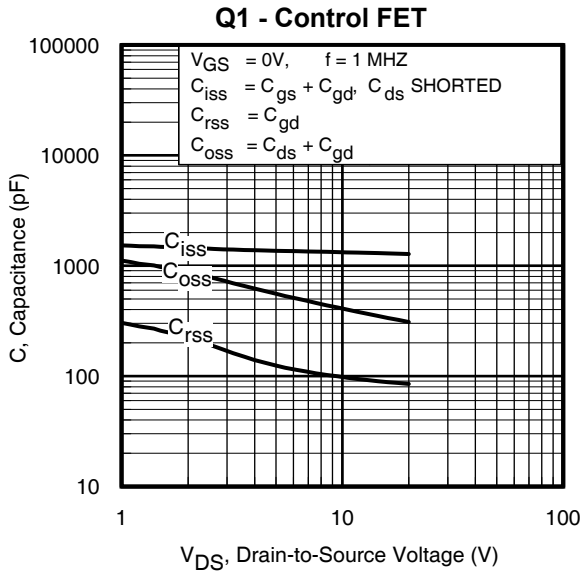
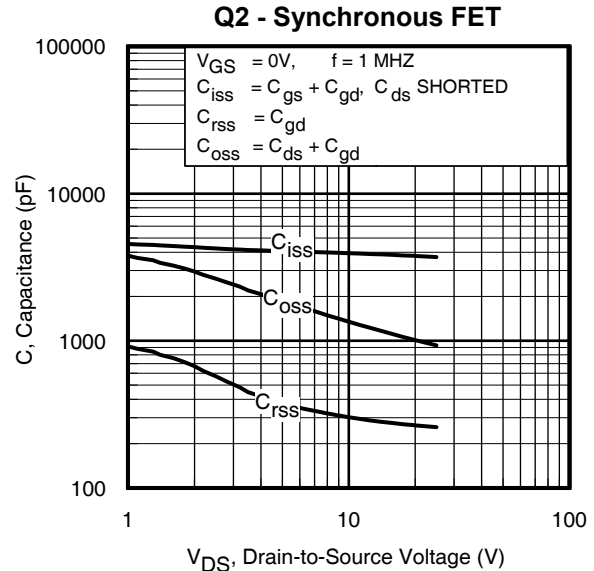
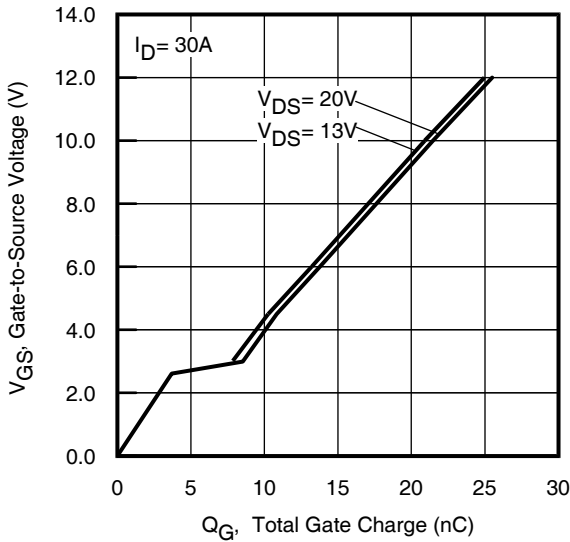
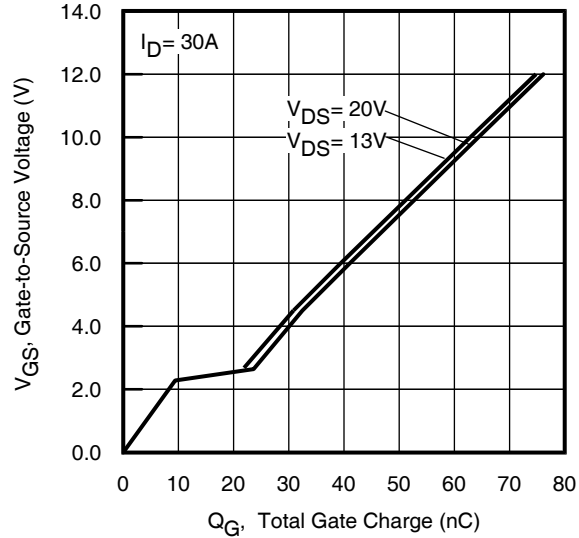
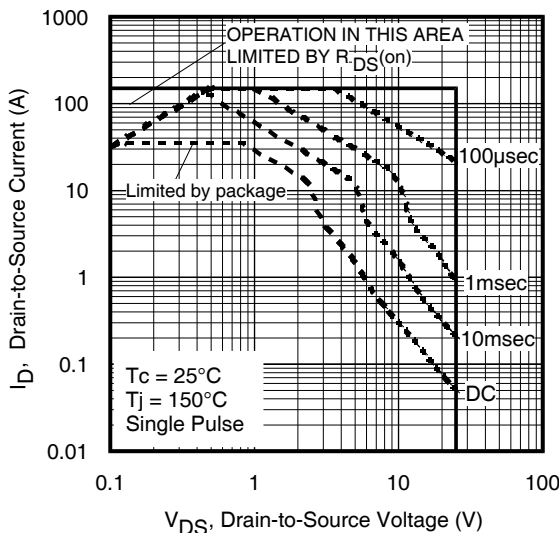
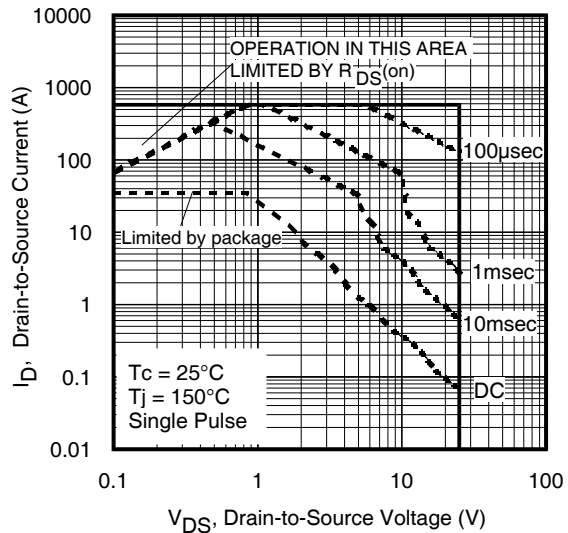
**Fig 2. Typical Output Characteristics**

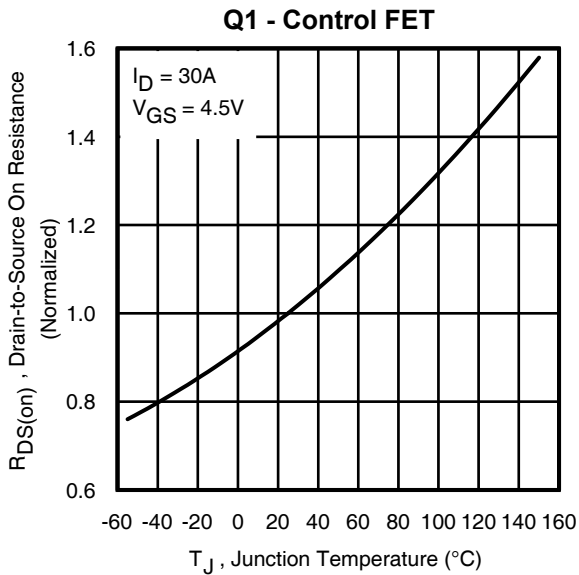
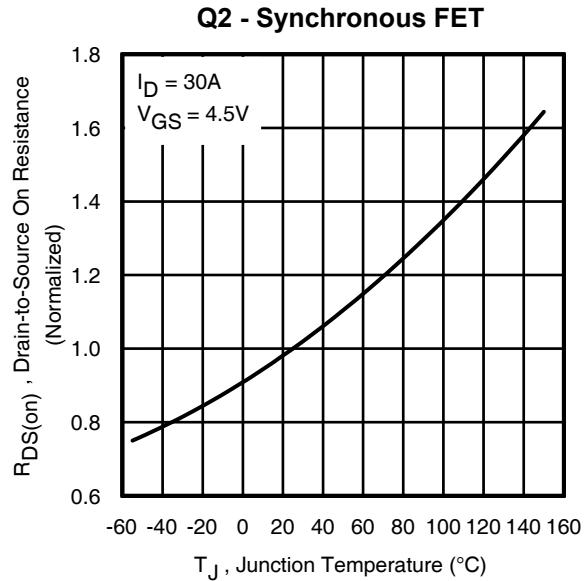
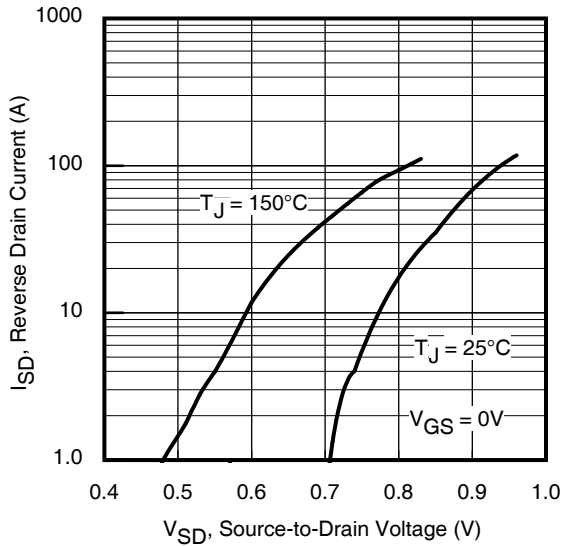
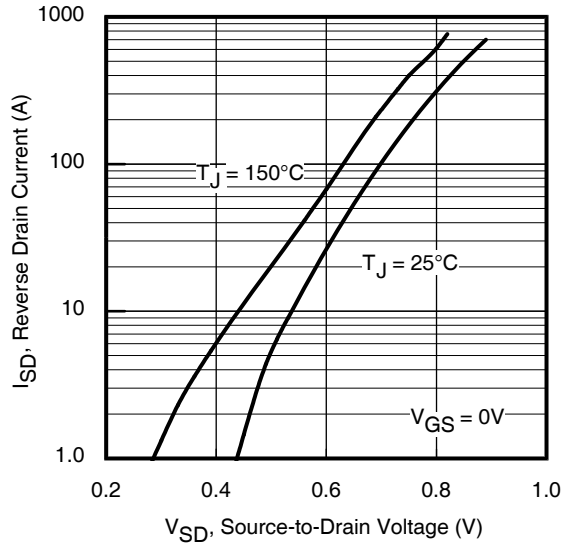
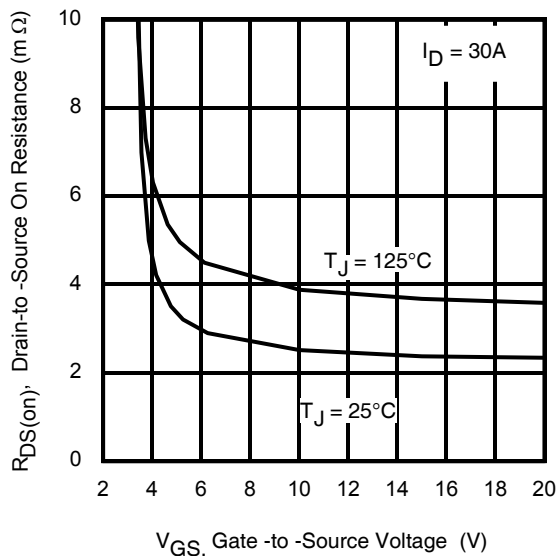
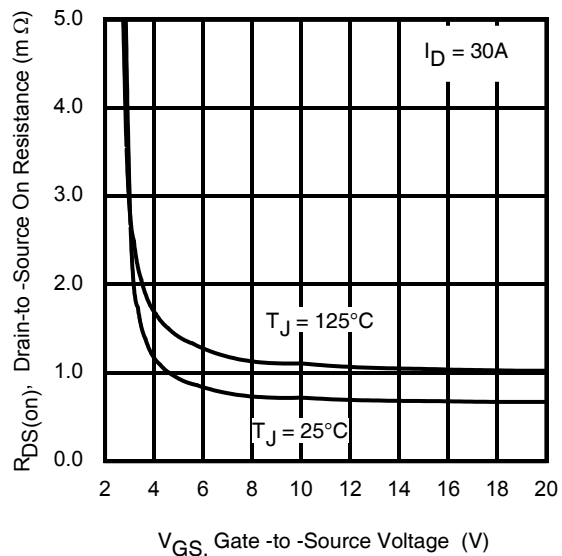
**Fig 3. Typical Output Characteristics**

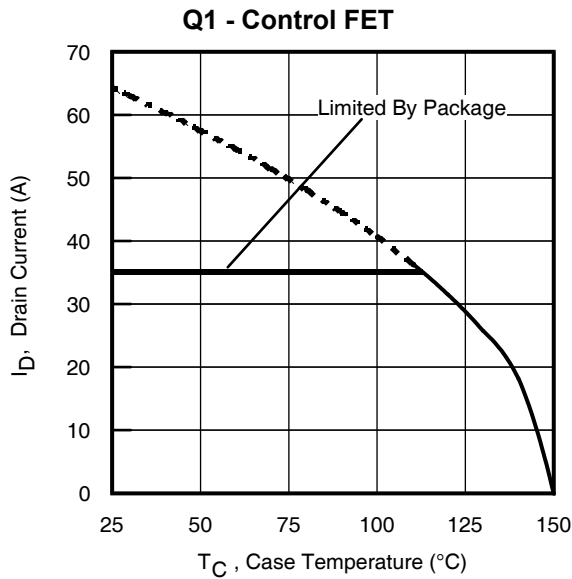
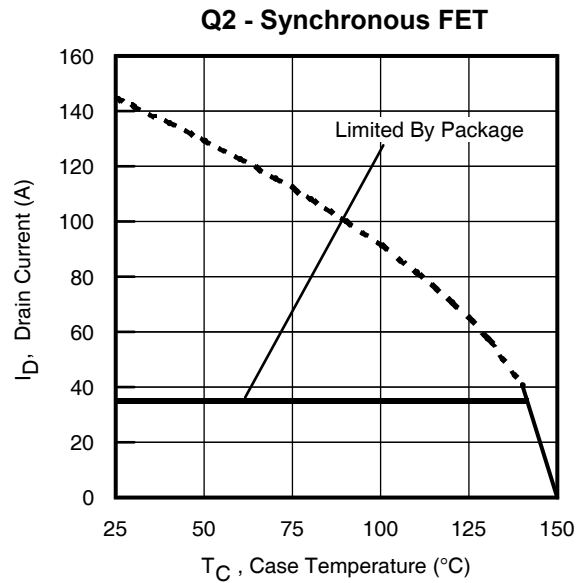
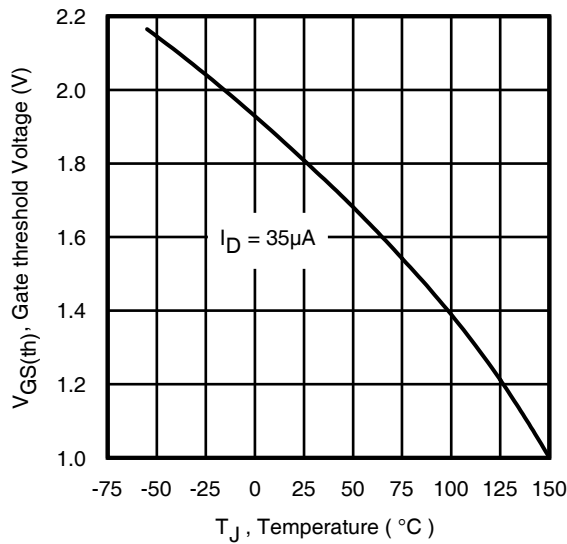
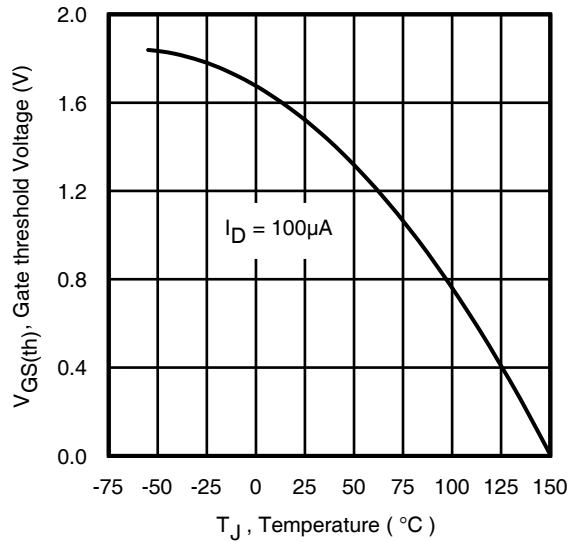
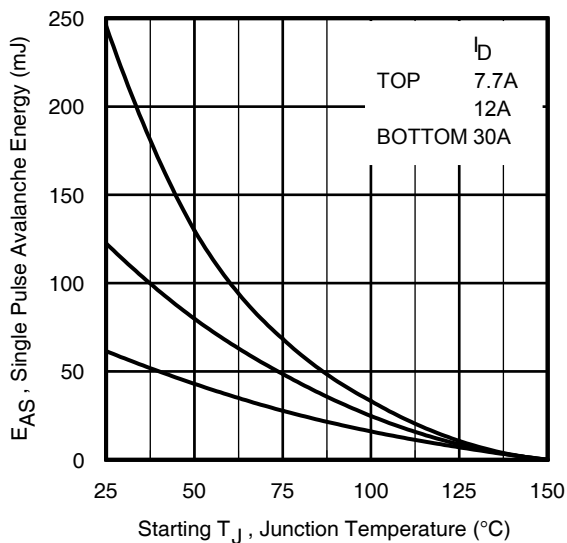
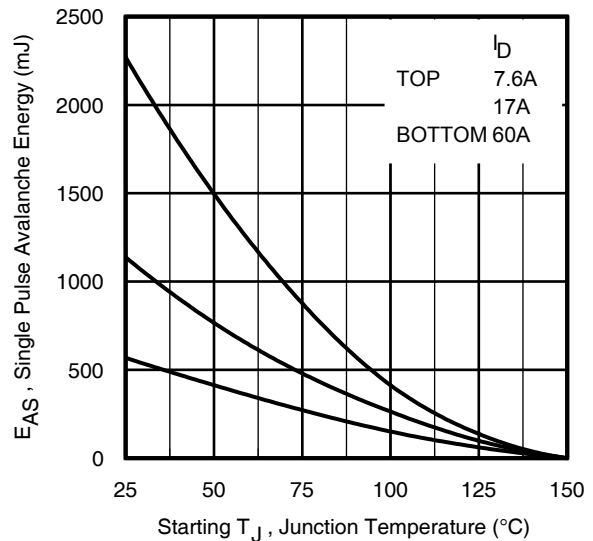
**Fig 4. Typical Output Characteristics**

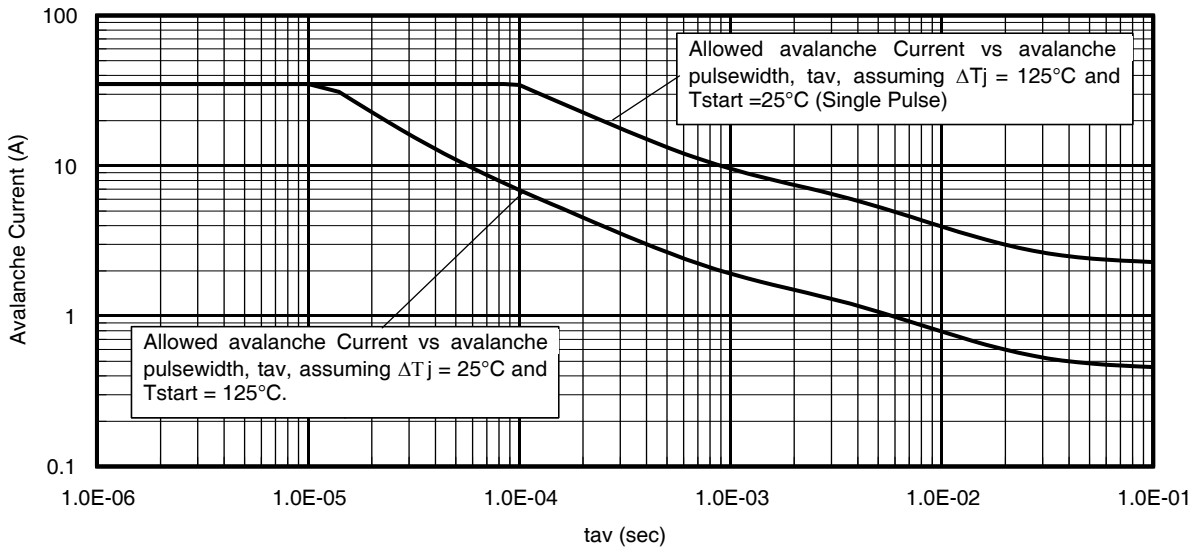
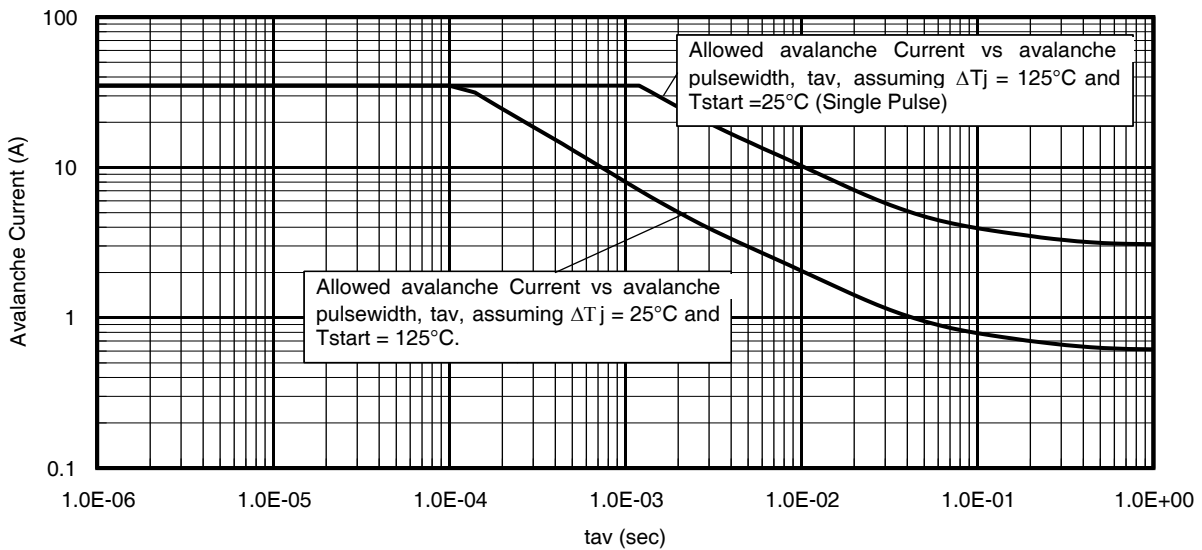
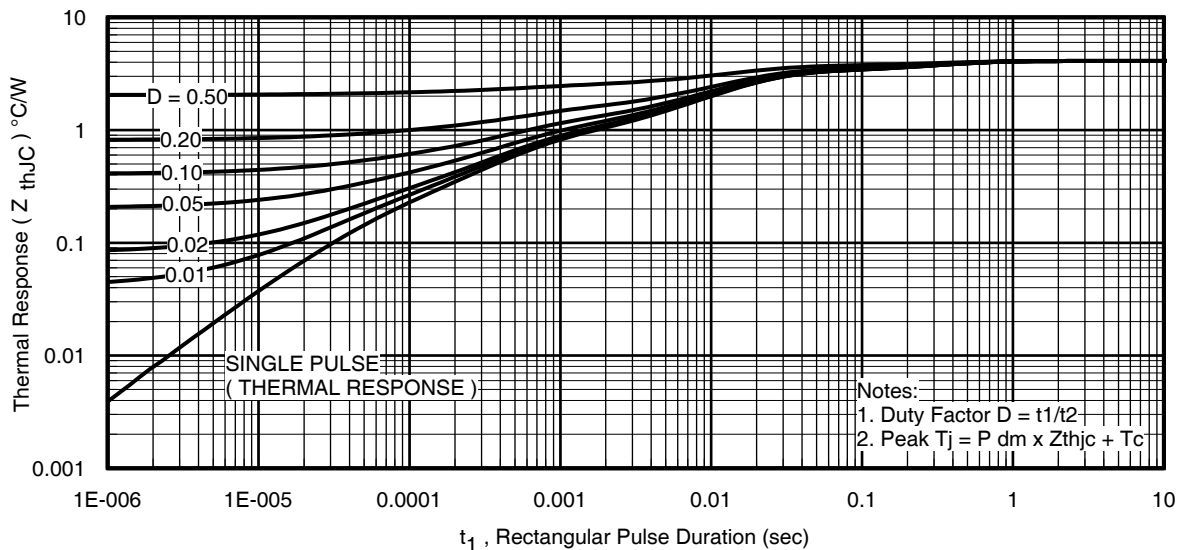
**Fig 5. Typical Transfer Characteristics**

**Fig 6. Typical Transfer Characteristics**

**Fig 7.** Typical Capacitance vs. Drain-to-Source Voltage

**Fig 8.** Typical Capacitance vs. Drain-to-Source Voltage

**Fig 9.** Typical Gate Charge vs. Gate-to-Source Voltage

**Fig 10.** Typical Gate Charge vs. Gate-to-Source Voltage

**Fig 11.** Maximum Safe Operating Area

**Fig 12.** Maximum Safe Operating Area

**Fig 13. Normalized On-Resistance vs. Temperature**

**Fig 14. Normalized On-Resistance vs. Temperature**

**Fig 15. Typical Source-Drain Diode Forward Voltage**

**Fig 16. Typical Source-Drain Diode Forward Voltage**

**Fig 17. Typical On-Resistance vs. Gate Voltage**

**Fig 18. Typical On-Resistance vs. Gate Voltage**

**Fig 19.** Maximum Drain Current vs. Case Temperature

**Fig 20.** Maximum Drain Current vs. Case Temperature

**Fig 21.** Threshold Voltage vs. Temperature

**Fig 22.** Threshold Voltage vs. Temperature

**Fig 23.** Maximum Avalanche Energy vs. Drain Current

**Fig 24.** Maximum Avalanche Energy vs. Drain Current

**Fig 25. Max Avalanche Current vs. Pulse Width (Q1)**

**Fig 26. Max Avalanche Current vs. Pulse Width (Q2)**

**Fig 27. Maximum Effective Transient Thermal Impedance, Junction-to-Case (Q1)**



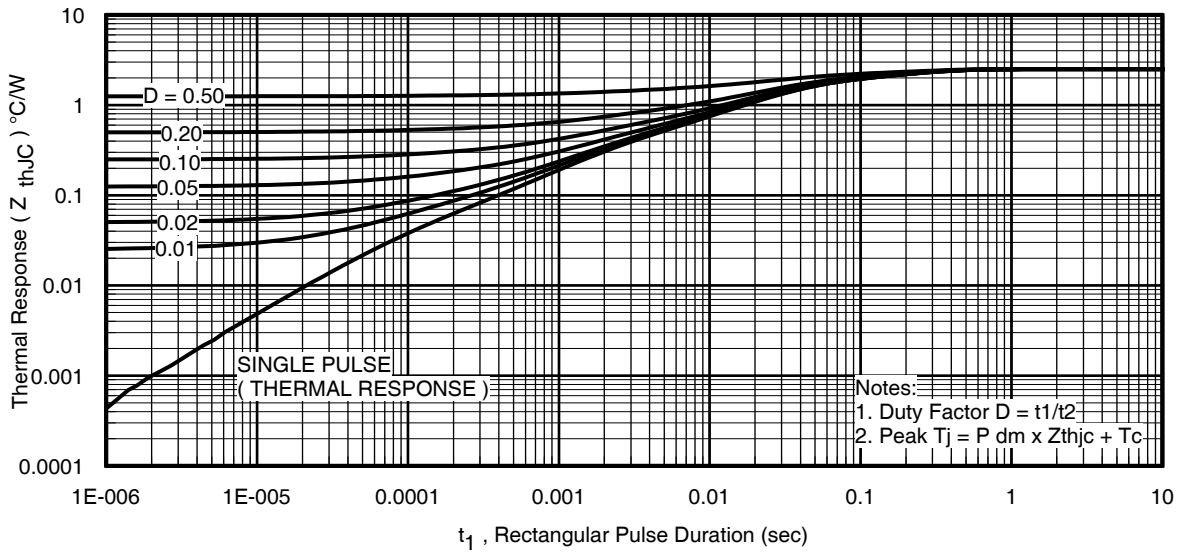
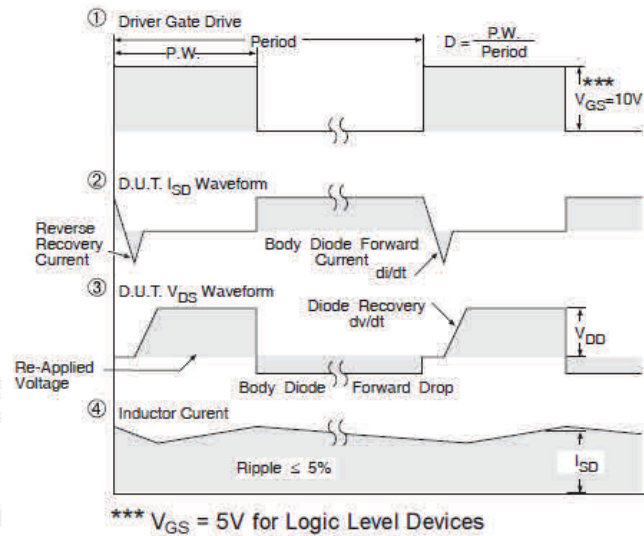
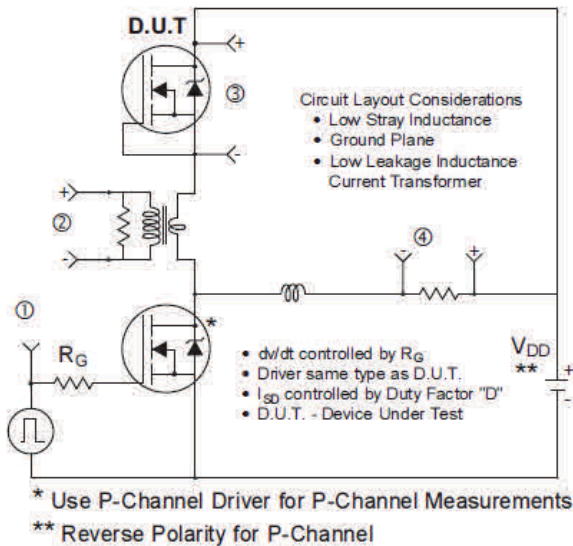
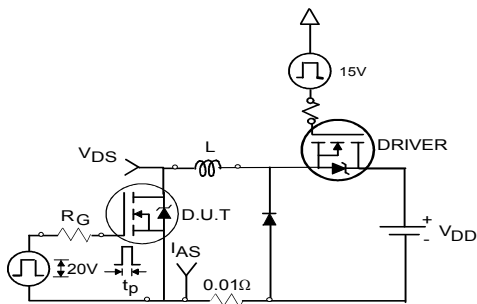
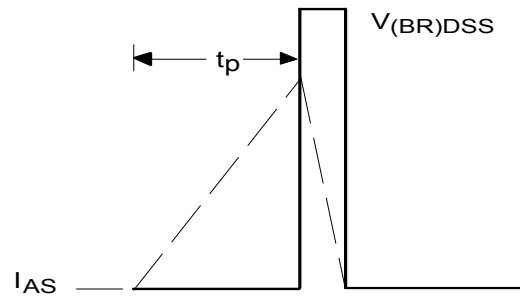
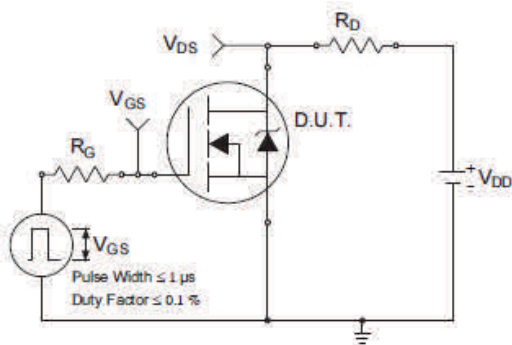
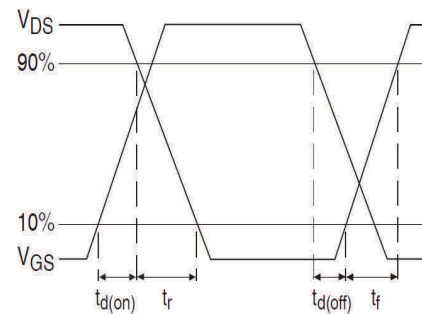
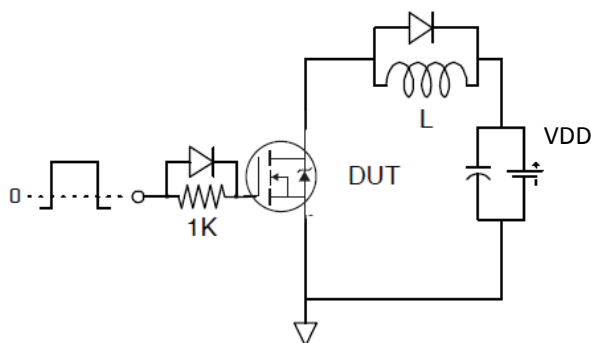
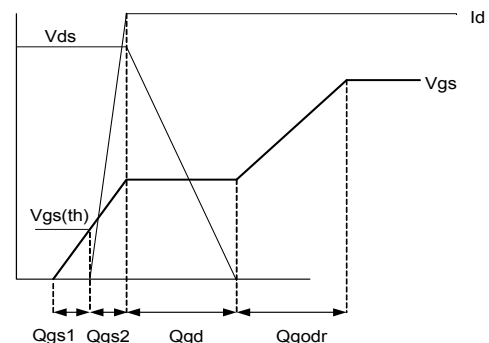
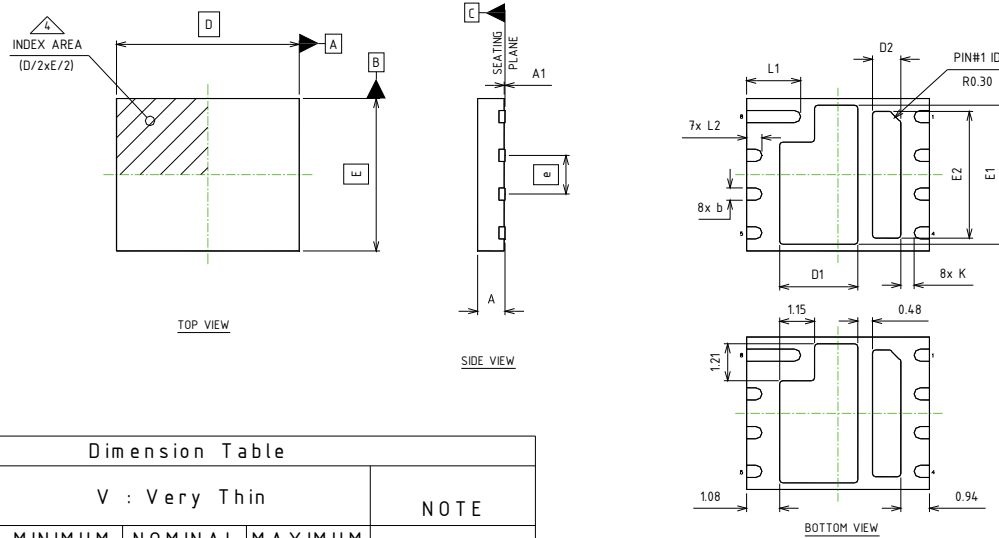

Fig 28. Maximum Effective Transient Thermal Impedance, Junction-to-Case (Q2)

**Fig 29. Peak Diode Recovery  $dv/dt$  Test Circuit for N-Channel HEXFET® Power MOSFETs**

**Fig 30a. Unclamped Inductive Test Circuit**

**Fig 30b. Unclamped Inductive Waveforms**

**Fig 31a. Switching Time Test Circuit**

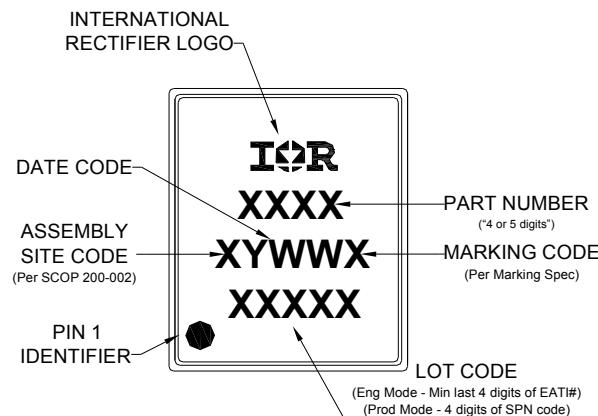
**Fig 31b. Switching Time Waveforms**

**Fig 32a. Gate Charge Test Circuit**

**Fig 32b. Gate Charge Waveform**

**Dual PQFN 5x6 Outline "H" Package Details**

Dimension Table				NOTE
Thickness Symbol	V : Very Thin			
	MINIMUM	NOMINAL	MAXIMUM	
A	0.80	0.90	1.00	
A1	0.00	0.02	0.05	
b	0.30	0.40	0.50	6
D	6.00 BSC			
E	5.00 BSC			
e	1.27 BSC			
D1	2.42	2.57	2.67	
E1	4.41	4.56	4.66	
D2	0.78	0.93	1.03	
E2	4.01	4.16	4.26	
K	0.20	---	---	
L1	1.67	1.77	1.87	
L2	0.40	0.50	0.60	

For more information on board mounting, including footprint and stencil recommendation, please refer to application note AN-1136: <http://www.irf.com/technical-info/appnotes/an-1136.pdf>  
 For more information on package inspection techniques, please refer to application note AN-1154: <http://www.irf.com/technical-info/appnotes/an-1154.pdf>

**PQFN 5x6 Outline "H" Part Marking**

Note: For the most current drawing please refer to IR website at <http://www.irf.com/package/>

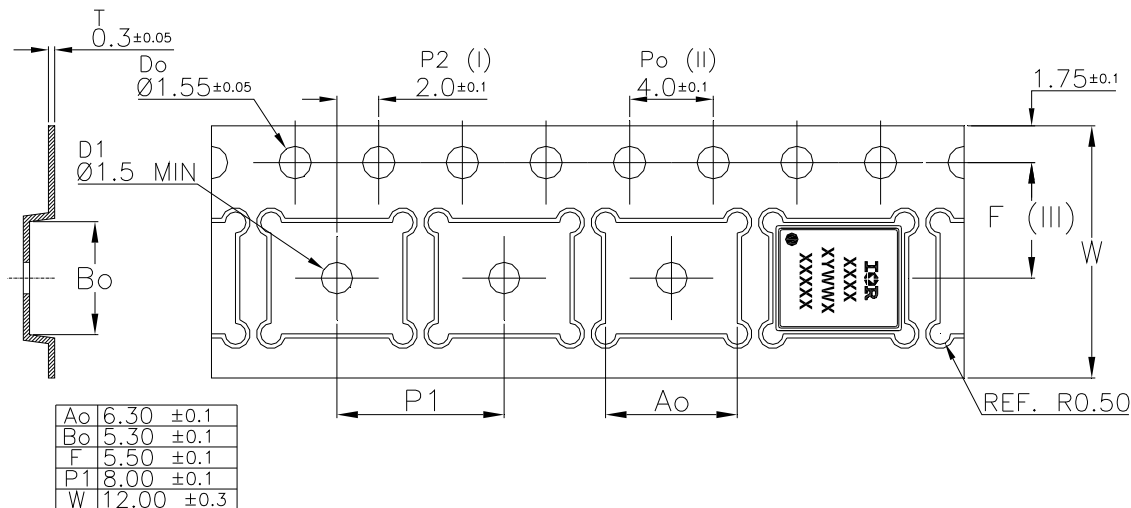
**Dual PQFN 5x6 Outline Tape and Reel**

Note: For the most current drawing please refer to IR website at <http://www.irf.com/package/>

**Qualification Information†**

<b>Qualification level</b>	Industrial (per JEDEC JESD47F †† guidelines )	
<b>Moisture Sensitivity Level</b>	DUAL PQFN 5mm x 6mm	MSL1 (per JEDEC J-STD-020D††)
<b>RoHS Compliant</b>	Yes	

† Qualification standards can be found at International Rectifier's web site <http://www.irf.com/product-info/reliability>

†† Applicable version of JEDEC standard at the time of product release.

**Notes:**

- ① Repetitive rating; pulse width limited by max. junction temperature.
- ② Starting  $T_j = 25^\circ\text{C}$ ,  
Q1:  $L = 0.14\text{mH}$ ,  $R_G = 50\Omega$ ,  $I_{AS} = 30\text{A}$ ;  
Q2:  $L = 0.32\text{mH}$ ,  $R_G = 50\Omega$ ,  $I_{AS} = 60\text{A}$ .
- ③ Pulse width  $\leq 400\mu\text{s}$ ; duty cycle  $\leq 2\%$ .
- ④  $R_\theta$  is measured at  $T_j$  approximately  $90^\circ\text{C}$ .
- ⑤ When mounted on 1 inch square PCB (FR-4). Please refer to AN-994 for more details:  
<http://www.irf.com/technical-info/appnotes/an-994.pdf>
- ⑥ Calculated continuous current based on maximum allowable junction temperature.
- ⑦ Current is limited to Q1 = 35A & Q2 = 35A by source bonding technology.
- ⑧ Pulsed drain current is limited to 140A by source bonding technology.

**Revision History**

Date	Comments
08/06/2013	<ul style="list-style-type: none"> <li>• Added the Fast/RFET logo, on page 1.</li> <li>• Changed the package limitation current from 45A to 35A, on page 1.</li> <li>• Added the part marking drawing, on page 11.</li> </ul>
01/16/2014	<ul style="list-style-type: none"> <li>• Updated the MSL level from MSL2 to MSL1, on page 1 &amp; 12.</li> </ul>
05/21/2014	<ul style="list-style-type: none"> <li>• Updated fig. 25 to show the max avalanche plateau at 35A, on page 8.</li> <li>• Corrected fig. 26 to cap the curves at package limitation current of 35A, on page 8.</li> </ul>

International  
 Rectifier

**IR WORLD HEADQUARTERS:** 101 N. Sepulveda Blvd., El Segundo, California 90245, USA

To contact International Rectifier, please visit <http://www.irf.com/whoto-call/>

## **IMPORTANT NOTICE**

The information given in this document shall in no event be regarded as a guarantee of conditions or characteristics ("Beschaffheitsgarantie").

With respect to any examples, hints or any typical values stated herein and/or any information regarding the application of the product, Infineon Technologies hereby disclaims any and all warranties and liabilities of any kind, including without limitation warranties of non-infringement of intellectual property rights of any third party.

In addition, any information given in this document is subject to customer's compliance with its obligations stated in this document and any applicable legal requirements, norms and standards concerning customer's products and any use of the product of Infineon Technologies in customer's applications.

The data contained in this document is exclusively intended for technically trained staff. It is the responsibility of customer's technical departments to evaluate the suitability of the product for the intended application and the completeness of the product information given in this document with respect to such application.

For further information on the product, technology, delivery terms and conditions and prices please contact your nearest Infineon Technologies office ([www.infineon.com](http://www.infineon.com)).

## **WARNINGS**

Due to technical requirements products may contain dangerous substances. For information on the types in question please contact your nearest Infineon Technologies office.

Except as otherwise explicitly approved by Infineon Technologies in a written document signed by authorized representatives of Infineon Technologies, Infineon Technologies' products may not be used in any applications where a failure of the product or any consequences of the use thereof can reasonably be expected to result in personal injury.

## X-ON Electronics

Largest Supplier of Electrical and Electronic Components

*Click to view similar products for [MOSFET](#) category:*

*Click to view products by [Infineon](#) manufacturer:*

Other Similar products are found below :

[614233C](#) [648584F](#) [IRFD120](#) [JANTX2N5237](#) [FCA20N60\\_F109](#) [FDZ595PZ](#) [2SK2545\(Q,T\)](#) [405094E](#) [423220D](#) [TPCC8103,L1Q\(CM](#)  
[MIC4420CM-TR](#) [VN1206L](#) [614234A](#) [715780A](#) [NTNS3166NZT5G](#) [SSM6J414TU,LF\(T](#) [751625C](#) [BUK954R8-60E](#) [GROUP A 5962-](#)  
[8877003PA](#) [NTE6400](#) [SQJ402EP-T1-GE3](#) [2SK2614\(TE16L1,Q\)](#) [2N7002KW-FAI](#) [DMN1017UCP3-7](#) [EFC2J004NUZTDG](#) [ECH8691-TL-W](#)  
[FCAB21350L1](#) [P85W28HP2F-7071](#) [DMN1053UCP4-7](#) [NTE221](#) [NTE222](#) [NTE2384](#) [NTE2903](#) [NTE2941](#) [NTE2945](#) [NTE2946](#) [NTE2960](#)  
[NTE2967](#) [NTE2969](#) [NTE2976](#) [NTE6400A](#) [NTE2910](#) [NTE2916](#) [NTE2956](#) [NTE2911](#) [DMN2080UCB4-7](#) [TK10A80W,S4X\(S](#)  
[SSM6P54TU,LF](#) [SSM6P69NU,LF](#) [DMP22D4UFO-7B](#)