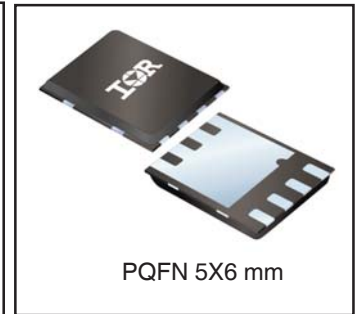
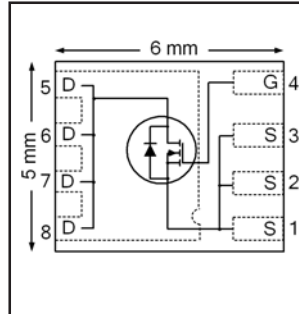


HEXFET® Power MOSFET

V_{DS}	100	V
$R_{DS(on) max}$ (@ $V_{GS} = 10V$)	12.4	mΩ
Q_g (typical)	54	nC
R_G (typical)	1.5	Ω
I_D (@ $T_{c(Bottom)} = 25^\circ C$)	63	A



Applications

- Secondary Side Synchronous Rectification
- Inverters for DC Motors
- DC-DC Brick Applications

Features and Benefits

Features

Low $R_{DS(on)}$ (< 12.4 mΩ)
Low Thermal Resistance to PCB (< 1.1°C/W)
100% R_g tested
Low Profile (<0.9 mm)
Industry-Standard Pinout
Compatible with Existing Surface Mount Techniques
RoHS Compliant Containing no Lead, no Bromide and no Halogen
MSL1, Industrial Qualification

Benefits

Lower Conduction Losses
Increased Power Density
Increased Reliability
Increased Power Density
Multi-Vendor Compatibility
Easier Manufacturing
Environmentally Friendlier
Increased Reliability

results in
⇒

Orderable part number	Package Type	Standard Pack		Note
		Form	Quantity	
IRFH5110TRPbF	PQFN 5mm x 6mm	Tape and Reel	4000	
IRFH5110TR2PbF	PQFN 5mm x 6mm	Tape and Reel	400	EOL notice # 259

Absolute Maximum Ratings

	Parameter	Max.	Units
V_{DS}	Drain-to-Source Voltage	100	V
V_{GS}	Gate-to-Source Voltage	± 20	
$I_D @ T_A = 25^\circ C$	Continuous Drain Current, $V_{GS} @ 10V$	11	A
$I_D @ T_A = 70^\circ C$	Continuous Drain Current, $V_{GS} @ 10V$	9.0	
$I_D @ T_{C(Bottom)} = 25^\circ C$	Continuous Drain Current, $V_{GS} @ 10V$	63	
$I_D @ T_{C(Bottom)} = 100^\circ C$	Continuous Drain Current, $V_{GS} @ 10V$	40	
I_{DM}	Pulsed Drain Current ①	252	
$P_D @ T_A = 25^\circ C$	Power Dissipation ②	3.6	W
$P_D @ T_{C(Bottom)} = 25^\circ C$	Power Dissipation ②	114	
	Linear Derating Factor ③	0.029	W/°C
T_J	Operating Junction and	-55 to + 150	°C
T_{STG}	Storage Temperature Range		

Notes ① through ⑤ are on page 9

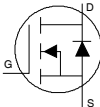
Static @ T_J = 25°C (unless otherwise specified)

	Parameter	Min.	Typ.	Max.	Units	Conditions
BV _{DSS}	Drain-to-Source Breakdown Voltage	100	—	—	V	V _{GS} = 0V, I _D = 250μA
ΔBV _{DSS} /ΔT _J	Breakdown Voltage Temp. Coefficient	—	0.11	—	V/°C	Reference to 25°C, I _D = 1.0mA
R _{DS(on)}	Static Drain-to-Source On-Resistance	—	10.3	12.4	mΩ	V _{GS} = 10V, I _D = 37A ③
V _{GS(th)}	Gate Threshold Voltage	2.0	—	4.0	V	V _{DS} = V _{GS} , I _D = 100μA
ΔV _{GS(th)}	Gate Threshold Voltage Coefficient	—	-8.8	—	mV/°C	
I _{DSS}	Drain-to-Source Leakage Current	—	—	20	μA	V _{DS} = 100V, V _{GS} = 0V
		—	—	250		V _{DS} = 100V, V _{GS} = 0V, T _J = 125°C
I _{GSS}	Gate-to-Source Forward Leakage	—	—	100	nA	V _{GS} = 20V
	Gate-to-Source Reverse Leakage	—	—	-100		V _{GS} = -20V
g _{fs}	Forward Transconductance	286	—	—	S	V _{DS} = 25V, I _D = 37A
Q _g	Total Gate Charge	—	54	81	nC	V _{DS} = 50V V _{GS} = 10V I _D = 37A
Q _{gs1}	Pre-V _{th} Gate-to-Source Charge	—	13	—		
Q _{gs2}	Post-V _{th} Gate-to-Source Charge	—	3.9	—		
Q _{gd}	Gate-to-Drain Charge	—	15	—		
Q _{godr}	Gate Charge Overdrive	—	22	—		
Q _{sw}	Switch Charge (Q _{gs2} + Q _{gd})	—	19	—		
Q _{oss}	Output Charge	—	14	—	nC	V _{DS} = 16V, V _{GS} = 0V
R _G	Gate Resistance	—	1.5	—	Ω	
t _{d(on)}	Turn-On Delay Time	—	7.8	—	ns	V _{DD} = 50V, V _{GS} = 10V I _D = 37A R _G = 1.3Ω
t _r	Rise Time	—	9.6	—		
t _{d(off)}	Turn-Off Delay Time	—	22	—		
t _f	Fall Time	—	6.4	—		
C _{iss}	Input Capacitance	—	3152	—	pF	V _{GS} = 0V V _{DS} = 25V f = 1.0MHz
C _{oss}	Output Capacitance	—	324	—		
C _{riss}	Reverse Transfer Capacitance	—	121	—		

Avalanche Characteristics

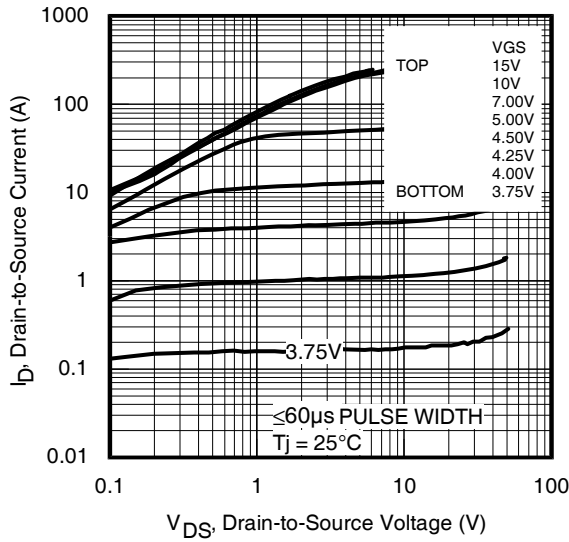
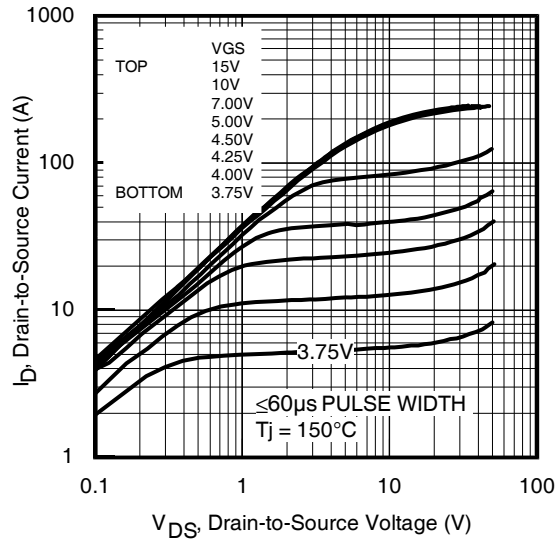
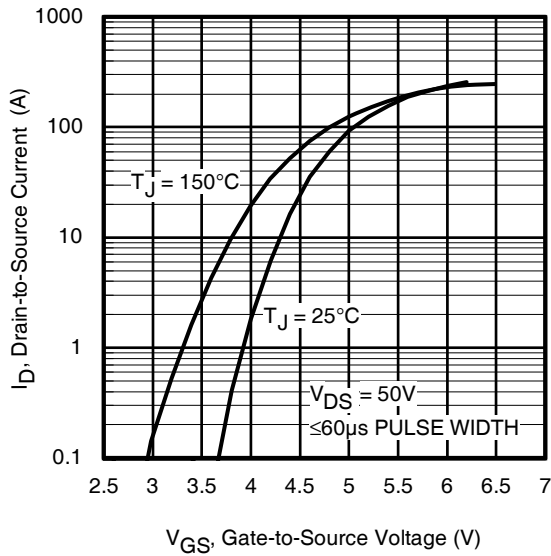
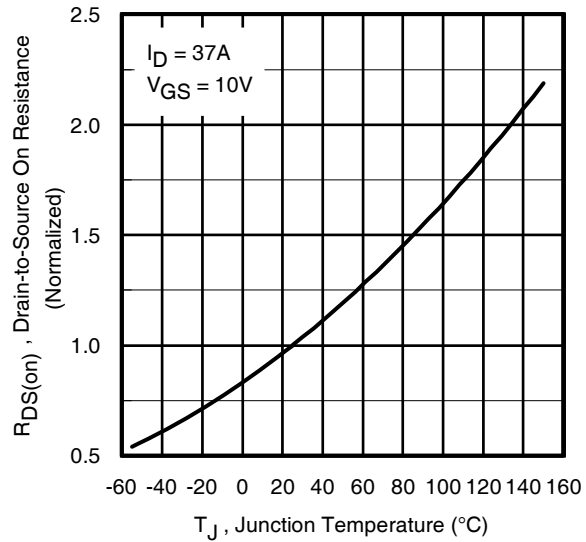
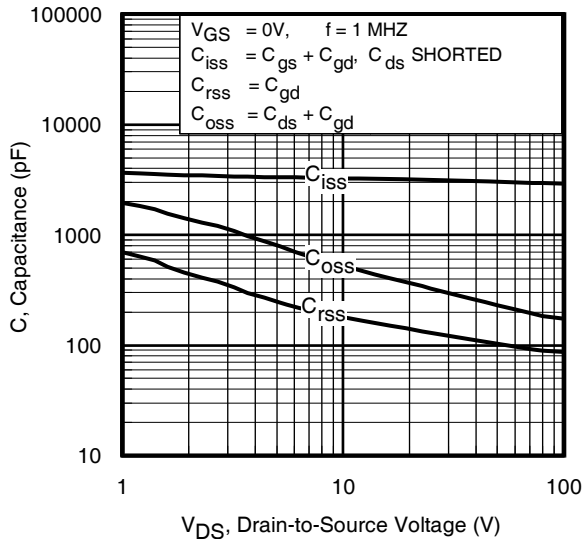
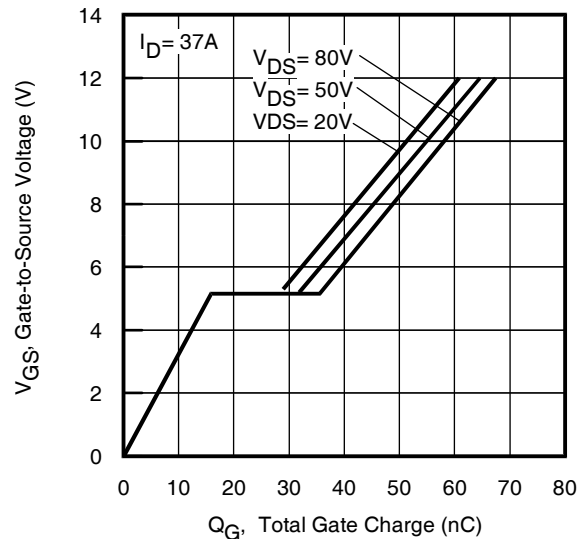
	Parameter	Typ.	Max.	Units
E _{AS}	Single Pulse Avalanche Energy ②	—	93	mJ
I _{AR}	Avalanche Current ①	—	37	A

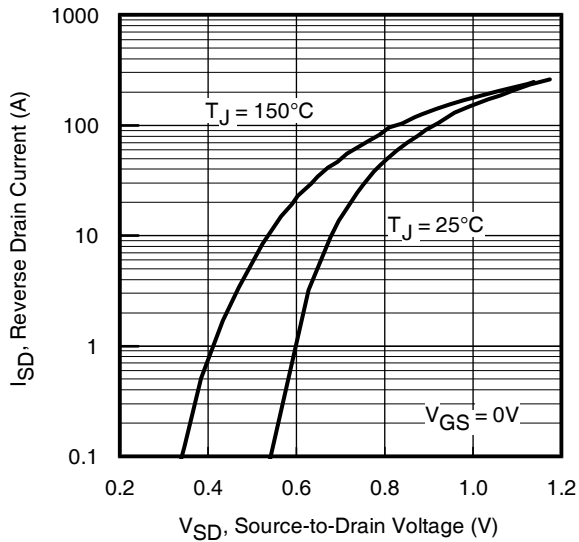
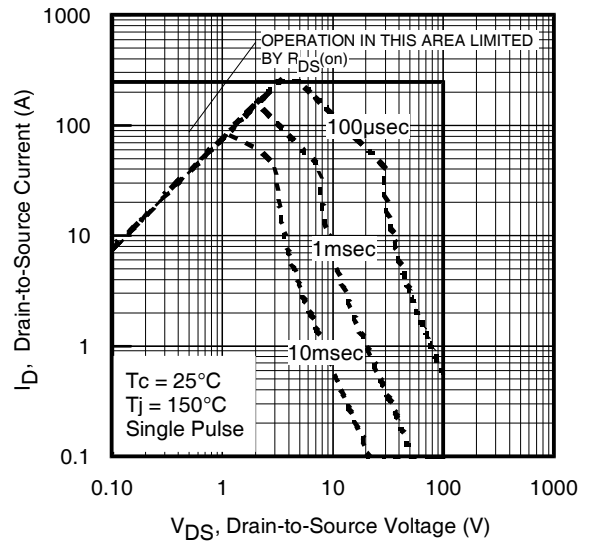
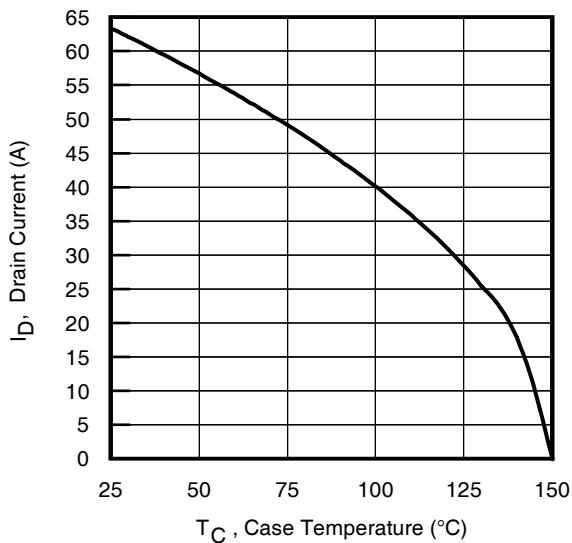
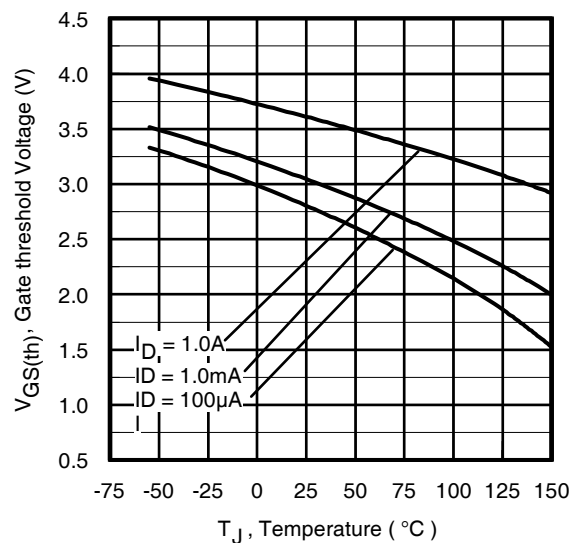
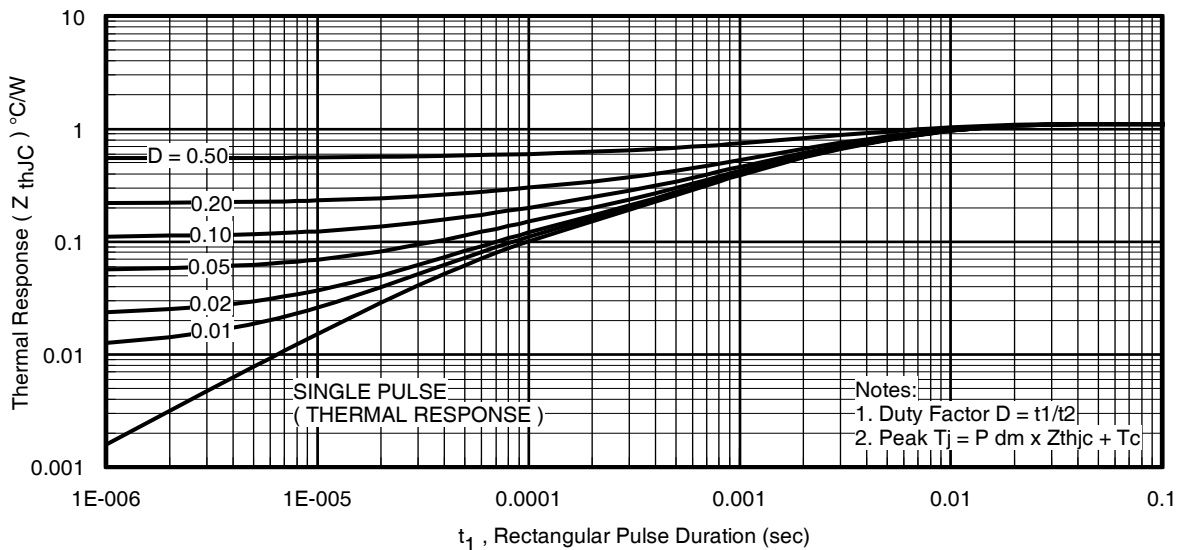
Diode Characteristics

	Parameter	Min.	Typ.	Max.	Units	Conditions
I _S	Continuous Source Current (Body Diode)	—	—	63	A	MOSFET symbol showing the integral reverse p-n junction diode. 
I _{SM}	Pulsed Source Current (Body Diode) ①	—	—	252		
V _{SD}	Diode Forward Voltage	—	—	1.3	V	T _J = 25°C, I _S = 37A, V _{GS} = 0V ③
t _{rr}	Reverse Recovery Time	—	34	51	ns	T _J = 25°C, I _F = 37A, V _{DD} = 50V
Q _{rr}	Reverse Recovery Charge	—	237	356	nC	di/dt = 500A/μs ③
t _{on}	Forward Turn-On Time	Time is dominated by parasitic Inductance				

Thermal Resistance

	Parameter	Typ.	Max.	Units
R _{θJC} (Bottom)	Junction-to-Case ④	—	1.1	°C/W
R _{θJC} (Top)	Junction-to-Case ④	—	15	
R _{θJA}	Junction-to-Ambient ⑤	—	35	
R _{θJA} (<10s)	Junction-to-Ambient ⑤	—	22	


Fig 1. Typical Output Characteristics

Fig 2. Typical Output Characteristics

Fig 3. Typical Transfer Characteristics

Fig 4. Normalized On-Resistance Vs. Temperature

Fig 5. Typical Capacitance Vs. Drain-to-Source Voltage

Fig 6. Typical Gate Charge Vs. Gate-to-Source Voltage


Fig 7. Typical Source-Drain Diode Forward Voltage

Fig 8. Maximum Safe Operating Area

Fig 9. Maximum Drain Current Vs. Case (Bottom) Temperature

Fig 10. Threshold Voltage Vs. Temperature

Fig 11. Maximum Effective Transient Thermal Impedance, Junction-to-Case (Bottom)

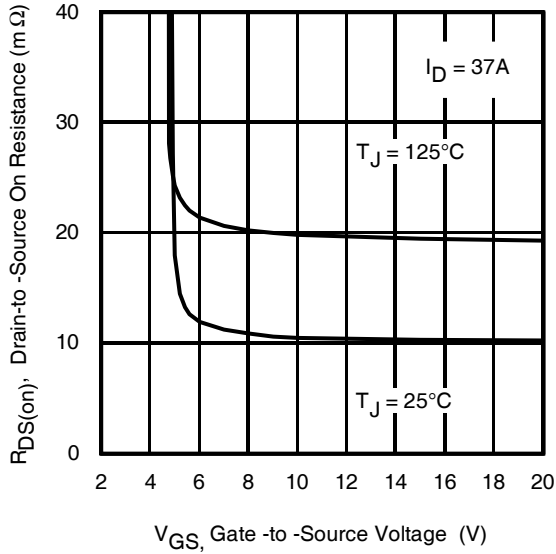
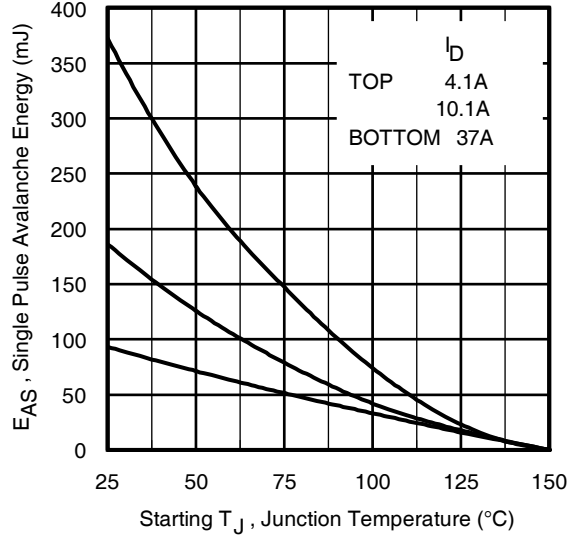

Fig 12. On-Resistance vs. Gate Voltage

Fig 13. Maximum Avalanche Energy vs. Drain Current

Fig 14a. Unclamped Inductive Test Circuit

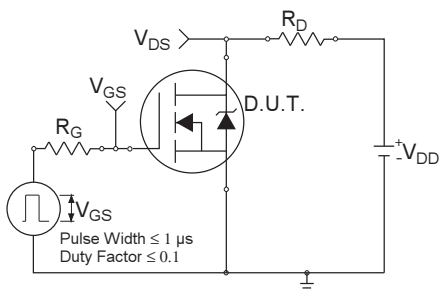
Fig 14b. Unclamped Inductive Waveforms

Fig 15a. Switching Time Test Circuit

Fig 15b. Switching Time Waveforms

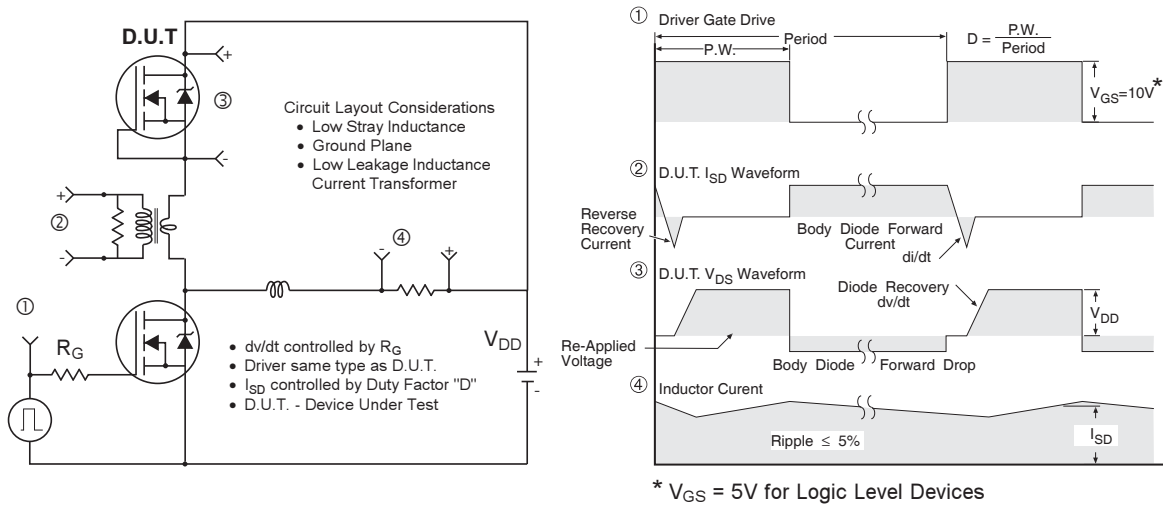


Fig 16. Peak Diode Recovery dv/dt Test Circuit for N-Channel HEXFET® Power MOSFETs



Fig 17. Gate Charge Test Circuit

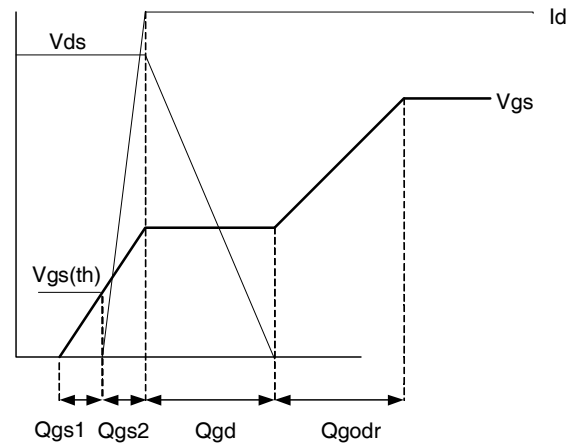
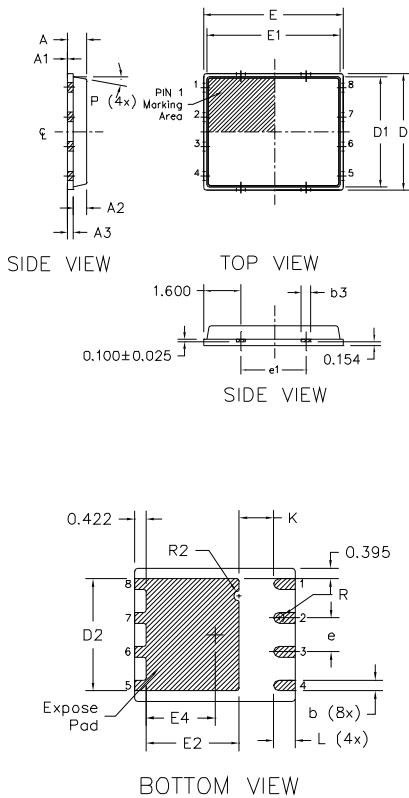


Fig 18. Gate Charge Waveform

PQFN 5x6 Outline "B" Package Details



DIM SYMBOL	MILLIMETERS		INCH	
	MIN	MAX	MIN	MAX
A	0.800	0.900	0.0315	0.0543
A1	0.000	0.050	0.0000	0.0020
A3	0.200 REF		0.0079 REF	
b	0.350	0.470	0.0138	0.0185
b1	0.025	0.125	0.0010	0.0049
b2	0.210	0.410	0.0083	0.0161
b3	0.150	0.450	0.0059	0.0177
D	5.000 BSC		0.1969 BSC	
D1	4.750 BSC		0.1870 BSC	
D2	4.100	4.300	0.1614	0.1693
E	6.000 BSC		0.2362 BSC	
E1	5.750 BSC		0.2264 BSC	
E2	3.380	3.780	0.1331	0.1488
e	1.270 REF		0.0500 REF	
e1	2.800 REF		0.1102 REF	
K	1.200	1.420	0.0472	0.0559
L	0.710	0.900	0.0280	0.0354
P	0°	12°	0°	12°
R	0.200 REF		0.0079 REF	
R2	0.150	0.200	0.0059	0.0079

- Note:*
- Dimensions and tolerancing confirm to ASME Y14.5M-1994
 - Dimension L represents terminal full back from package edge up to 0.1mm is acceptable
 - Coplanarity applies to the expose Heat Slug as well as the terminal
 - Radius on terminal is Optional

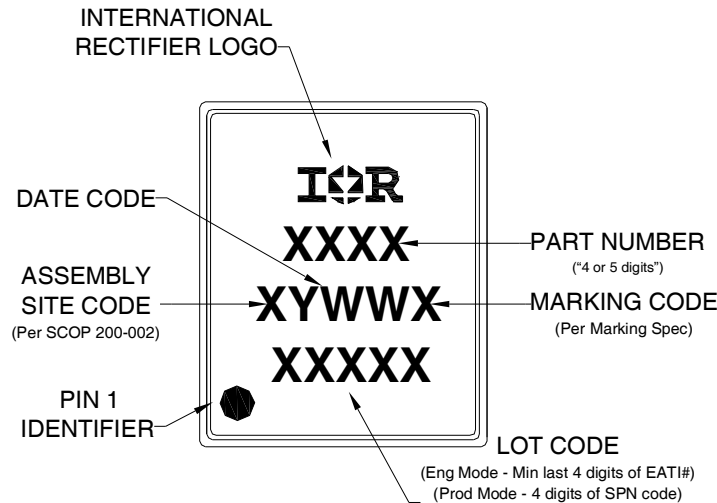
For more information on board mounting, including footprint and stencil recommendation, please refer to application note AN-1136:

<http://www.irf.com/technical-info/appnotes/an-1136.pdf>

For more information on package inspection techniques, please refer to application note AN-1154:

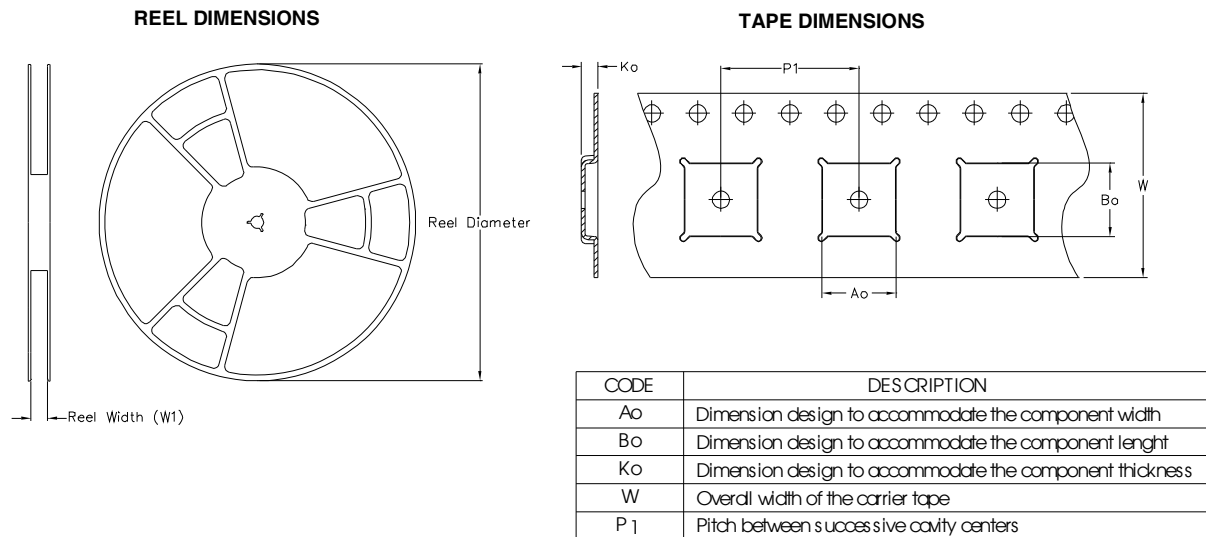
<http://www.irf.com/technical-info/appnotes/an-1154.pdf>

PQFN 5x6 Part Marking

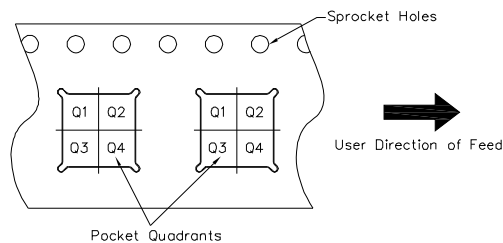


Note: For the most current drawing please refer to IR website at: <http://www.irf.com/package/>

PQFN 5x6 Tape and Reel



QUADRANT ASSIGNMENTS FOR PIN 1 ORIENTATION IN TAPE



Note: All dimension are nominal

Package Type	Reel Diameter (Inch)	QTY	Reel Width W1 (mm)	Ao (mm)	Bo (mm)	Ko (mm)	P1 (mm)	W (mm)	Pin 1 Quadrant
5 X 6 PQFN	13	4000	12.4	6.300	5.300	1.20	8.00	12	Q1

Note: For the most current drawing please refer to IR website at: <http://www.irf.com/package/>

Qualification information[†]

Qualification level	Industriid ^{††} (per JEDEC JESD47F ^{†††} guidelines)	
Moisture Sensitivity Level	PQFN 5mm x 6mm	MSL1 (per JEDEC J-STD-020D ^{†††})
RoHS compliant	Yes	

† Qualification standards can be found at International Rectifier's web site

<http://www.irf.com/product-info/reliability>

†† Higher qualification ratings may be available should the user have such requirements.

Please contact your International Rectifier sales representative for further information:

<http://www.irf.com/whoto-call/salesrep/>

††† Applicable version of JEDEC standard at the time of product release.

Notes:

- ① Repetitive rating; pulse width limited by max. junction temperature.
- ② Starting $T_J = 25^\circ\text{C}$, $L = 0.136\text{mH}$, $R_G = 50\Omega$, $I_{AS} = 37\text{A}$.
- ③ Pulse width $\leq 400\mu\text{s}$; duty cycle $\leq 2\%$.
- ④ R_θ is measured at T_J of approximately 90°C .
- ⑤ When mounted on 1 inch square 2 oz copper pad on 1.5x1.5 in. board of FR-4 material.

Revision History

Date	Comments
12/16/2013	<ul style="list-style-type: none"> • Updated ordering information to reflect the End-Of-life (EOL) of the mini-reel option (EOL notice #259) • Updated data sheet with new IR corporate template
3/12/2015	<ul style="list-style-type: none"> • Updated package outline and tape and reel on pages 7 and 8.

International
 Rectifier

IR WORLD HEADQUARTERS: 101 N. Sepulveda Blvd., El Segundo, California 90245, USA
 To contact International Rectifier, please visit <http://www.irf.com/whoto-call/>

IMPORTANT NOTICE

The information given in this document shall in no event be regarded as a guarantee of conditions or characteristics ("Beschaffheitsgarantie").

With respect to any examples, hints or any typical values stated herein and/or any information regarding the application of the product, Infineon Technologies hereby disclaims any and all warranties and liabilities of any kind, including without limitation warranties of non-infringement of intellectual property rights of any third party.

In addition, any information given in this document is subject to customer's compliance with its obligations stated in this document and any applicable legal requirements, norms and standards concerning customer's products and any use of the product of Infineon Technologies in customer's applications.

The data contained in this document is exclusively intended for technically trained staff. It is the responsibility of customer's technical departments to evaluate the suitability of the product for the intended application and the completeness of the product information given in this document with respect to such application.

For further information on the product, technology, delivery terms and conditions and prices please contact your nearest Infineon Technologies office (www.infineon.com).

WARNINGS

Due to technical requirements products may contain dangerous substances. For information on the types in question please contact your nearest Infineon Technologies office.

Except as otherwise explicitly approved by Infineon Technologies in a written document signed by authorized representatives of Infineon Technologies, Infineon Technologies' products may not be used in any applications where a failure of the product or any consequences of the use thereof can reasonably be expected to result in personal injury.

X-ON Electronics

Largest Supplier of Electrical and Electronic Components

Click to view similar products for [MOSFET](#) category:

Click to view products by [Infineon](#) manufacturer:

Other Similar products are found below :

[614233C](#) [648584F](#) [IRFD120](#) [JANTX2N5237](#) [FCA20N60_F109](#) [FDZ595PZ](#) [2SK2545\(Q,T\)](#) [405094E](#) [423220D](#) [TPCC8103,L1Q\(CM](#)
[MIC4420CM-TR](#) [VN1206L](#) [614234A](#) [715780A](#) [NTNS3166NZT5G](#) [SSM6J414TU,LF\(T](#) [751625C](#) [BUK954R8-60E](#) [GROUP A 5962-](#)
[8877003PA](#) [NTE6400](#) [SQJ402EP-T1-GE3](#) [2SK2614\(TE16L1,Q\)](#) [2N7002KW-FAI](#) [DMN1017UCP3-7](#) [EFC2J004NUZTDG](#) [ECH8691-TL-W](#)
[FCAB21350L1](#) [P85W28HP2F-7071](#) [DMN1053UCP4-7](#) [NTE221](#) [NTE222](#) [NTE2384](#) [NTE2903](#) [NTE2941](#) [NTE2945](#) [NTE2946](#) [NTE2960](#)
[NTE2967](#) [NTE2969](#) [NTE2976](#) [NTE6400A](#) [NTE2910](#) [NTE2916](#) [NTE2956](#) [NTE2911](#) [DMN2080UCB4-7](#) [TK10A80W,S4X\(S](#)
[SSM6P69NU,LF](#) [DMP22D4UFO-7B](#) [DMN1006UCA6-7](#)