

HEXFET® Power MOSFET

V_{DS}	30	V
$V_{GS\ max}$	± 20	V
$R_{DS(on)\ max}$ (@ $V_{GS} = 10V$)	3.1	mΩ
(@ $V_{GS} = 4.5V$)	4.6	
$Q_g\ typ$	19	nC
I_D (@ $T_{C(Bottom)} = 25°C$)	50 ⑦	A

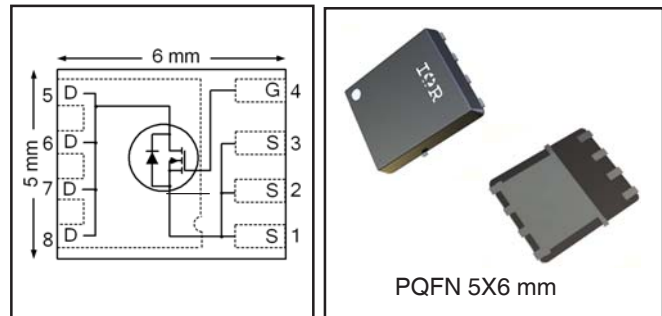

Applications

- Synchronous MOSFET for high frequency buck converters

Features and Benefits

Features

Low Thermal Resistance to PCB (< 1.7°C/W)
Low Profile (<1.2mm)
Industry-Standard Pinout
Compatible with Existing Surface Mount Techniques
RoHS Compliant Containing no Lead, no Bromide and no Halogen
MSL1, Consumer Qualification

results in
⇒

Benefits

Enable better thermal dissipation
Increased Power Density
Multi-Vendor Compatibility
Easier Manufacturing
Environmentally Friendlier
Increased Reliability

Orderable part number	Package Type	Standard Pack		Note
		Form	Quantity	
IRFH8318TRPBF	PQFN 5mm x 6mm	Tape and Reel	4000	
IRFH8318TR2PBF	PQFN 5mm x 6mm	Tape and Reel	400	EOL notice # 259

Absolute Maximum Ratings

	Parameter	Max.	Units
V_{DS}	Drain-to-Source Voltage	30	V
V_{GS}	Gate-to-Source Voltage	± 20	
$I_D @ T_A = 25°C$	Continuous Drain Current, $V_{GS} @ 10V$	27	A
$I_D @ T_A = 70°C$	Continuous Drain Current, $V_{GS} @ 10V$	21	
$I_D @ T_{C(Bottom)} = 25°C$	Continuous Drain Current, $V_{GS} @ 10V$	120 ⑥ ⑦	
$I_D @ T_{C(Bottom)} = 100°C$	Continuous Drain Current, $V_{GS} @ 10V$	76 ⑥ ⑦	
$I_D @ T_C = 25°C$	Continuous Drain Current, $V_{GS} @ 10V$ (Package Limited)	50 ⑦	
I_{DM}	Pulsed Drain Current ①	400	
$P_D @ T_A = 25°C$	Power Dissipation ②	3.6	W
$P_D @ T_{C(Bottom)} = 25°C$	Power Dissipation ②	59	
	Linear Derating Factor ③	0.029	W/°C
T_J T_{STG}	Operating Junction and Storage Temperature Range	-55 to + 150	°C

Notes ① through ⑦ are on page 9

Static @ T_J = 25°C (unless otherwise specified)

	Parameter	Min.	Typ.	Max.	Units	Conditions
BV _{DSS}	Drain-to-Source Breakdown Voltage	30	—	—	V	V _{GS} = 0V, I _D = 250μA
ΔBV _{DSS} /ΔT _J	Breakdown Voltage Temp. Coefficient	—	0.019	—	V/°C	Reference to 25°C, I _D = 1.0mA
R _{DS(on)}	Static Drain-to-Source On-Resistance	—	2.5	3.1	mΩ	V _{GS} = 10V, I _D = 20A ③
		—	3.6	4.6		V _{GS} = 4.5V, I _D = 16A ③
V _{GS(th)}	Gate Threshold Voltage	1.35	1.8	2.35	V	V _{DS} = V _{GS} , I _D = 50μA
ΔV _{GS(th)}	Gate Threshold Voltage Coefficient	—	-6.0	—	mV/°C	
I _{DSS}	Drain-to-Source Leakage Current	—	—	1	μA	V _{DS} = 24V, V _{GS} = 0V
		—	—	150		V _{DS} = 24V, V _{GS} = 0V, T _J = 125°C
I _{GSS}	Gate-to-Source Forward Leakage	—	—	100	nA	V _{GS} = 20V
	Gate-to-Source Reverse Leakage	—	—	-100		V _{GS} = -20V
g _{fs}	Forward Transconductance	81	—	—	S	V _{DS} = 10V, I _D = 20A
Q _g	Total Gate Charge	—	41	—	nC	V _{GS} = 10V, V _{DS} = 15V, I _D = 20A
Q _g	Total Gate Charge	—	19	—	nC	V _{DS} = 15V V _{GS} = 4.5V I _D = 20A
Q _{gs1}	Pre-V _{th} Gate-to-Source Charge	—	5.8	—		
Q _{gs2}	Post-V _{th} Gate-to-Source Charge	—	2.3	—		
Q _{gd}	Gate-to-Drain Charge	—	4.4	—		
Q _{godr}	Gate Charge Overdrive	—	6.5	—		
Q _{sw}	Switch Charge (Q _{gs2} + Q _{gd})	—	6.7	—		
Q _{oss}	Output Charge	—	18	—	nC	V _{DS} = 16V, V _{GS} = 0V
R _G	Gate Resistance	—	1.7	—	Ω	
t _{d(on)}	Turn-On Delay Time	—	15	—	ns	V _{DD} = 15V, V _{GS} = 4.5V I _D = 20A R _G = 1.8Ω
t _r	Rise Time	—	33	—		
t _{d(off)}	Turn-Off Delay Time	—	18	—		
t _f	Fall Time	—	12	—		
C _{iss}	Input Capacitance	—	3180	—	pF	V _{GS} = 0V V _{DS} = 10V f = 1.0MHz
C _{oss}	Output Capacitance	—	700	—		
C _{rss}	Reverse Transfer Capacitance	—	270	—		

Avalanche Characteristics

	Parameter	Typ.	Max.	Units
E _{AS}	Single Pulse Avalanche Energy ②	—	160	mJ
I _{AR}	Avalanche Current ①	—	20	A

Diode Characteristics

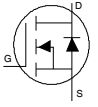
	Parameter	Min.	Typ.	Max.	Units	Conditions
I _S	Continuous Source Current (Body Diode)	—	—	50 ②	A	MOSFET symbol showing the integral reverse p-n junction diode. 
I _{SM}	Pulsed Source Current (Body Diode) ①	—	—	400		
V _{SD}	Diode Forward Voltage	—	—	1.0	V	T _J = 25°C, I _S = 20A, V _{GS} = 0V ③
t _{rr}	Reverse Recovery Time	—	16	24	ns	T _J = 25°C, I _F = 20A, V _{DD} = 15V
Q _{rr}	Reverse Recovery Charge	—	35	53	nC	di/dt = 380A/μs ③
t _{on}	Forward Turn-On Time	Time is dominated by parasitic Inductance				

Thermal Resistance

	Parameter	Typ.	Max.	Units
R _{θJC} (Bottom)	Junction-to-Case ④	—	1.7	°C/W
R _{θJC} (Top)	Junction-to-Case ④	—	32	
R _{θJA}	Junction-to-Ambient ⑤	—	35	
R _{θJA} (<10s)	Junction-to-Ambient ⑤	—	22	

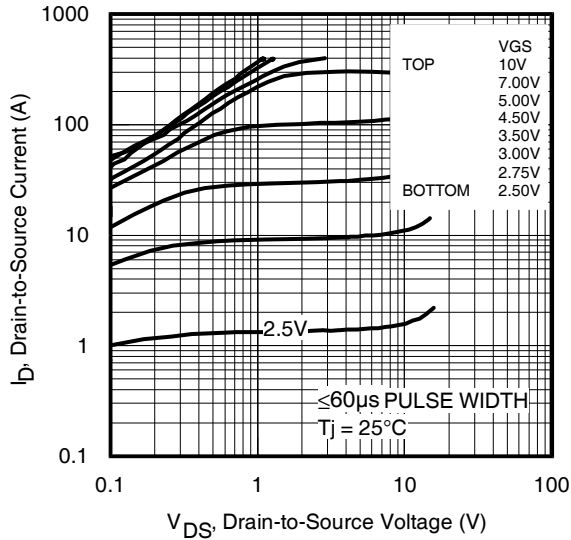
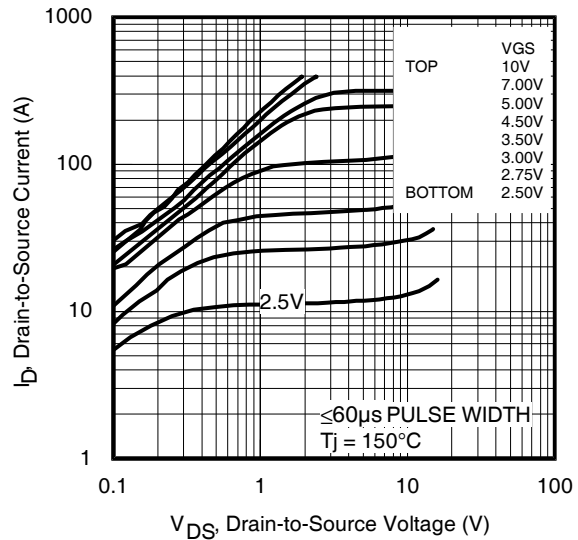
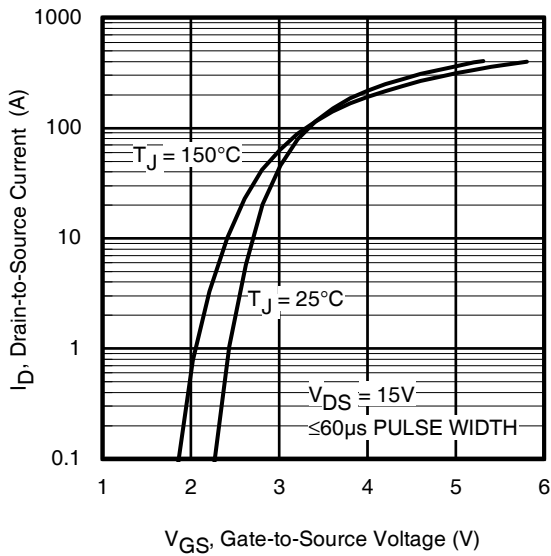
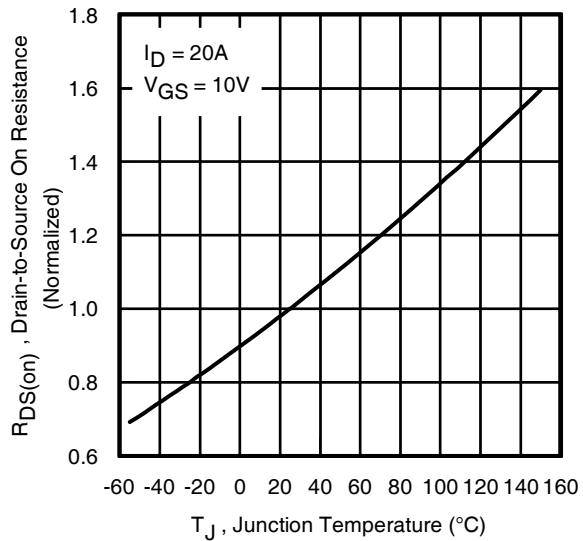
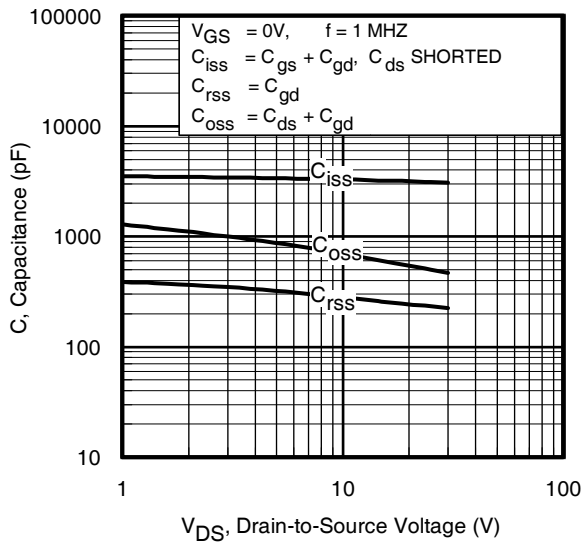
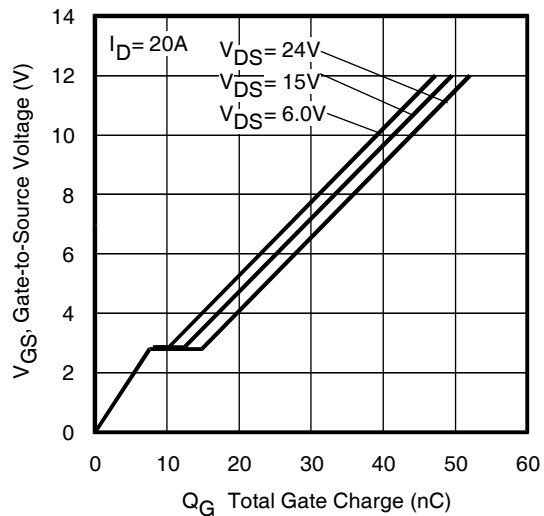
Fig 1. Typical Output Characteristics

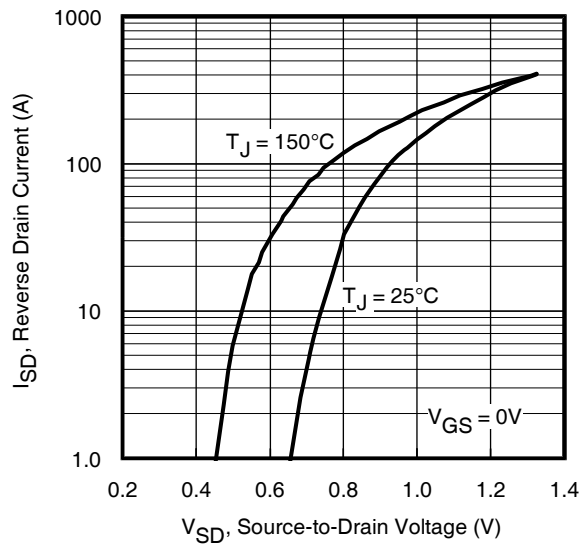
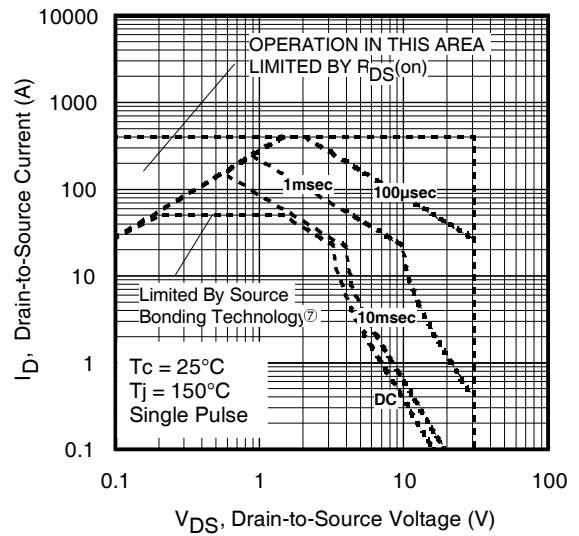
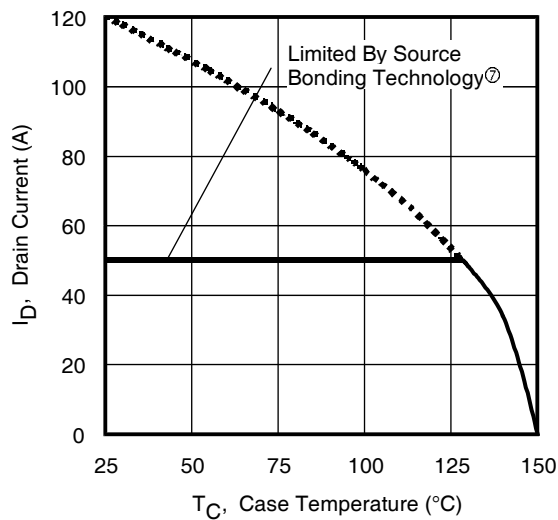
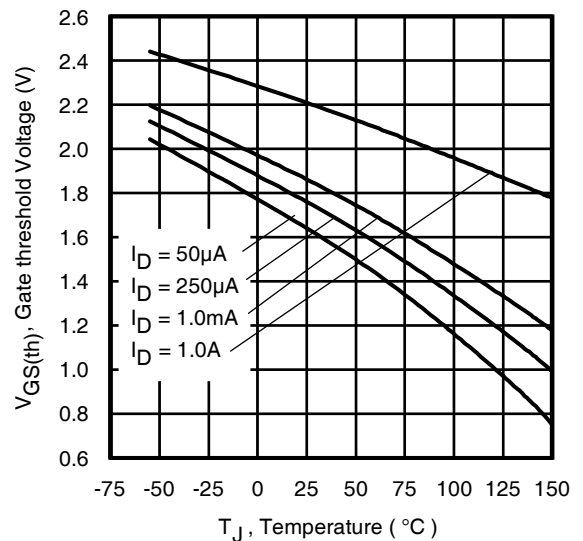
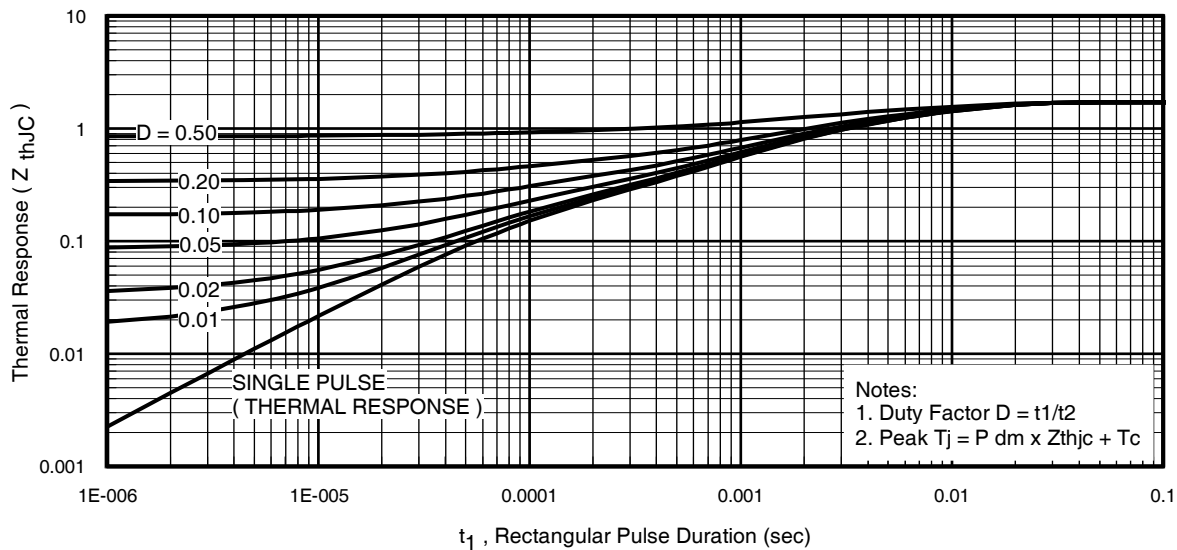
Fig 2. Typical Output Characteristics

Fig 3. Typical Transfer Characteristics

Fig 4. Normalized On-Resistance vs. Temperature

Fig 5. Typical Capacitance vs. Drain-to-Source Voltage

Fig 6. Typical Gate Charge vs. Gate-to-Source Voltage

Fig 7. Typical Source-Drain Diode Forward Voltage

Fig 8. Maximum Safe Operating Area

Fig 9. Maximum Drain Current vs. Case (Bottom) Temperature

Fig 10. Threshold Voltage vs. Temperature

Fig 11. Maximum Effective Transient Thermal Impedance, Junction-to-Case (Bottom)

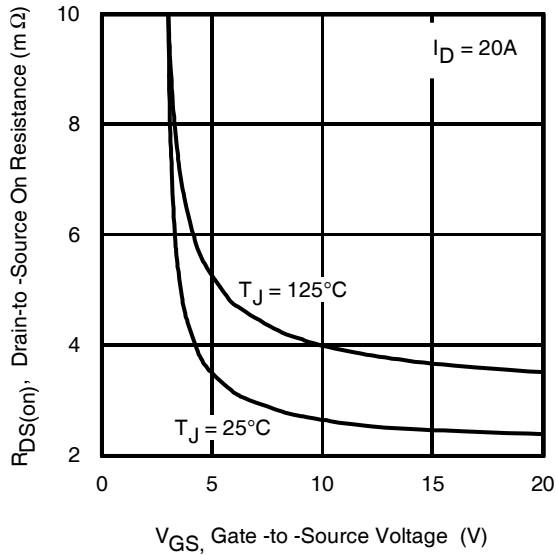
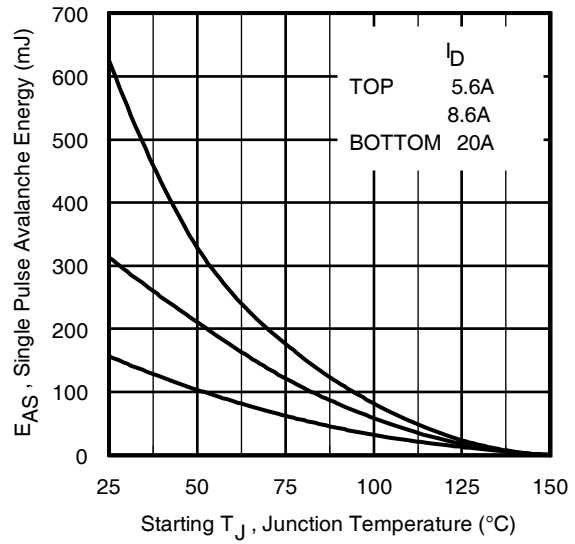
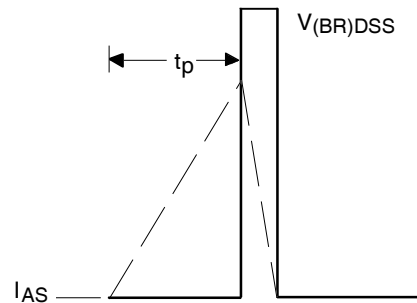
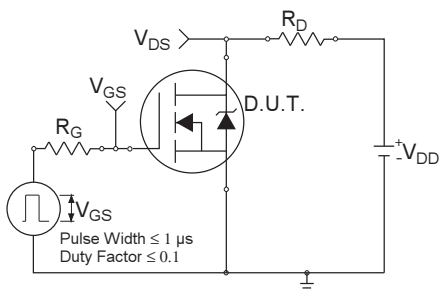
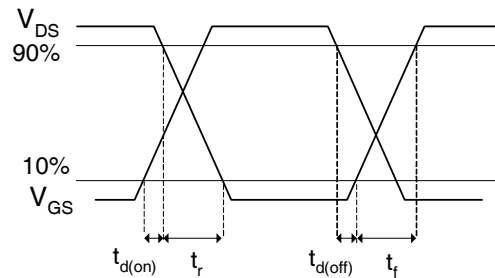

Fig 12. On-Resistance vs. Gate Voltage

Fig 13. Maximum Avalanche Energy vs. Drain Current

Fig 14a. Unclamped Inductive Test Circuit

Fig 14b. Unclamped Inductive Waveforms

Fig 15a. Switching Time Test Circuit

Fig 15b. Switching Time Waveforms

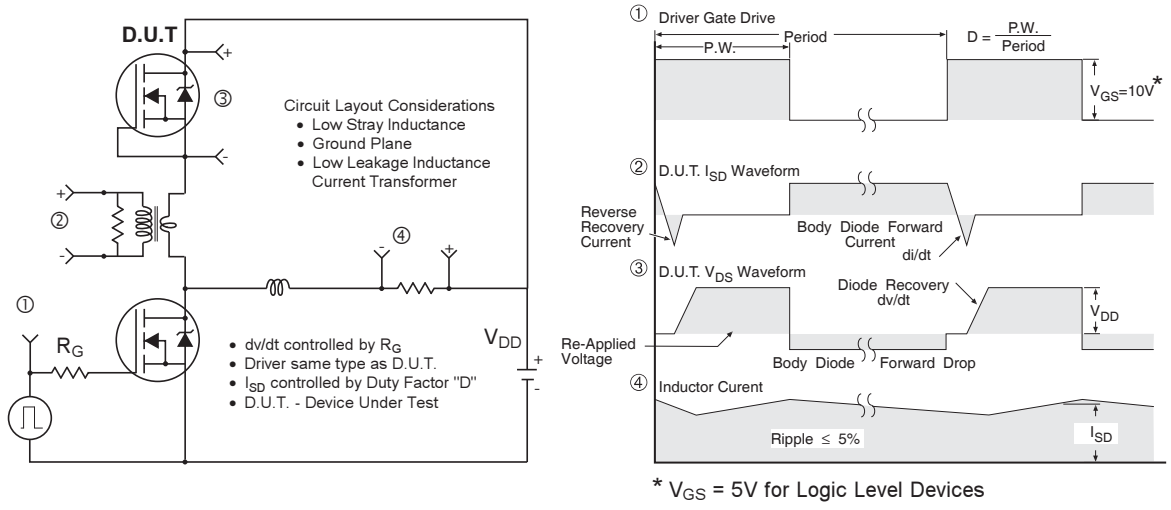

Fig 16. Peak Diode Recovery dv/dt Test Circuit for N-Channel HEXFET[®] Power MOSFETs



Fig 17. Gate Charge Test Circuit

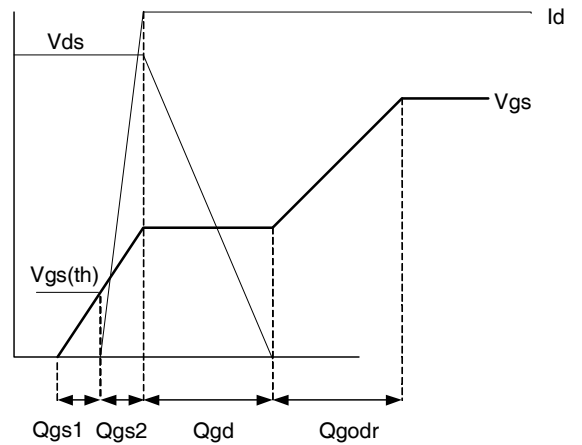
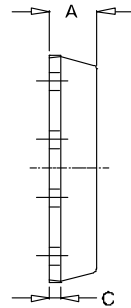
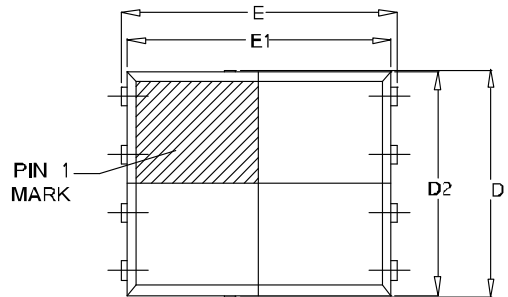

Fig 18. Gate Charge Waveform

PQFN 5x6 Outline "E" Package Details



SIDEVIEW



TOP VIEW

SYMBOL	OUTLINE PQFN 5X6E		
	MIN.	NOM.	MAX.
A	0.90	1.03	1.17
b	0.33	0.41	0.48
C	0.20	0.25	0.35
D	4.80	4.98	5.15
D1	3.91	4.11	4.31
D2	4.80	4.90	5.00
E	5.90	6.02	6.15
E1	5.65	5.75	5.85
E2	1.10	—	—
e	1.27 BSC		
L	0.05	0.15	0.25
L1	0.38	0.44	0.50
L2	0.51	0.68	0.86
H	3.32	3.45	3.58
I	—	—	0.18

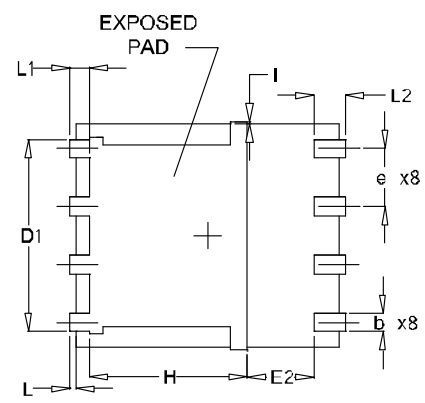

BOTTOM VIEW

For footprint and stencil design recommendations, please refer to application note AN-1154 at <http://www.irf.com/technical-info/appnotes/an-1154.pdf>

PQFN 5x6 Outline "E" Part Marking

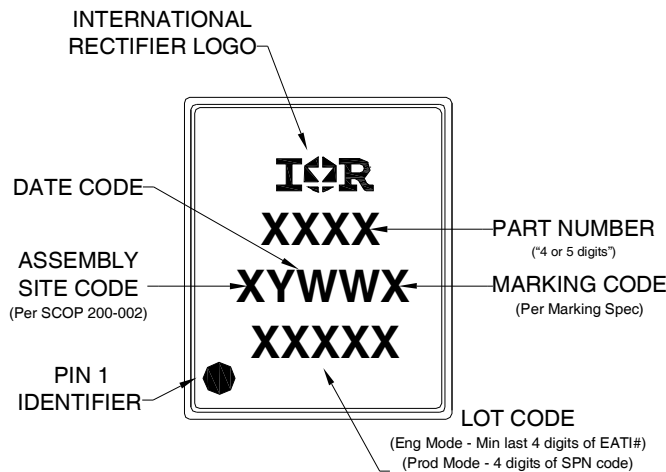

Note: For the most current drawing please refer to IR website at: <http://www.irf.com/package/>

PQFN 5x6 Outline "E" Tape and Reel

REEL DIMENSIONS

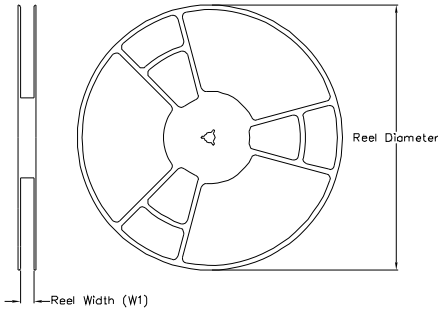

TAPE DIMENSIONS

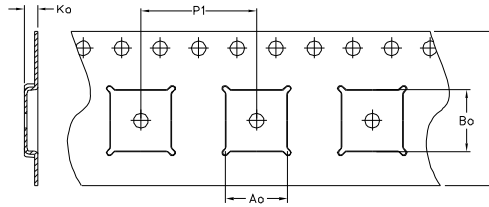

QUADRANT ASSIGNMENTS FOR PIN 1 ORIENTATION IN TAPE

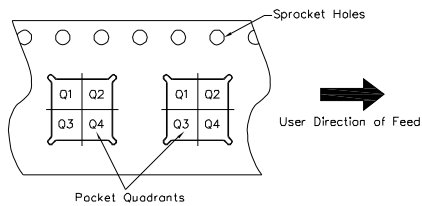

CODE	DIMENSION (MM)		DIMENSION (INCH)	
	MIN	MAX	MIN	MAX
Ao	6.20	6.40	.244	.252
Bo	5.20	5.40	.205	.213
Ko	1.10	1.30	.043	.051
P ₁	7.90	8.10	.311	.319
W	11.80	12.20	.465	.480
W ₁	12.30	12.50	.484	.492
Qty	4000			
Reel Diameter	13 Inches			

CODE	DESCRIPTION
Ao	Dimension design to accommodate the component width
Bo	Dimension design to accommodate the component length
Ko	Dimension design to accommodate the component thickness
W	Overall width of the carrier tape
P ₁	Pitch between successive cavity centers

Note: For the most current drawing please refer to IR website at: <http://www.irf.com/package/>

Qualification information[†]

Qualification level	Consumer ^{††} (per JEDEC JESD47F ^{†††} guidelines)	
Moisture Sensitivity Level	PQFN 5mm x 6mm	MSL1 (per JEDEC J-STD-020D ^{†††})
RoHS compliant	Yes	

† Qualification standards can be found at International Rectifier’s web site

<http://www.irf.com/product-info/reliability>

†† Higher qualification ratings may be available should the user have such requirements.
Please contact your International Rectifier sales representative for further information:

<http://www.irf.com/whoto-call/salesrep/>

††† Applicable version of JEDEC standard at the time of product release.

Notes:

- ① Repetitive rating; pulse width limited by max. junction temperature.
- ② Starting $T_J = 25^{\circ}\text{C}$, $L = 0.78\text{mH}$, $R_G = 50\Omega$, $I_{AS} = 20\text{A}$.
- ③ Pulse width $\leq 400\mu\text{s}$; duty cycle $\leq 2\%$.
- ④ R_{θ} is measured at T_J of approximately 90°C .
- ⑤ When mounted on 1 inch square 2 oz copper pad on 1.5x1.5 in. board of FR-4 material.
- ⑥ Calculated continuous current based on maximum allowable junction temperature.
- ⑦ Current is limited to 50A by source bonding technology.

Revision History

Date	Comment
5/13/2014	<ul style="list-style-type: none"> • Updated ordering information to reflect the End-Of-life (EOL) of the mini-reel option (EOL notice #259) • Updated Tape and Reel on page 8. • Updated data sheet based on corporate template.

IMPORTANT NOTICE

The information given in this document shall in no event be regarded as a guarantee of conditions or characteristics ("Beschaffenhheitsgarantie").

With respect to any examples, hints or any typical values stated herein and/or any information regarding the application of the product, Infineon Technologies hereby disclaims any and all warranties and liabilities of any kind, including without limitation warranties of non-infringement of intellectual property rights of any third party.

In addition, any information given in this document is subject to customer's compliance with its obligations stated in this document and any applicable legal requirements, norms and standards concerning customer's products and any use of the product of Infineon Technologies in customer's applications.

The data contained in this document is exclusively intended for technically trained staff. It is the responsibility of customer's technical departments to evaluate the suitability of the product for the intended application and the completeness of the product information given in this document with respect to such application.

For further information on the product, technology, delivery terms and conditions and prices please contact your nearest Infineon Technologies office (www.infineon.com).

WARNINGS

Due to technical requirements products may contain dangerous substances. For information on the types in question please contact your nearest Infineon Technologies office.

Except as otherwise explicitly approved by Infineon Technologies in a written document signed by authorized representatives of Infineon Technologies, Infineon Technologies' products may not be used in any applications where a failure of the product or any consequences of the use thereof can reasonably be expected to result in personal injury.

X-ON Electronics

Largest Supplier of Electrical and Electronic Components

Click to view similar products for [MOSFET](#) category:

Click to view products by [Infineon](#) manufacturer:

Other Similar products are found below :

[614233C](#) [648584F](#) [IRFD120](#) [JANTX2N5237](#) [FCA20N60_F109](#) [FDZ595PZ](#) [2SK2545\(Q,T\)](#) [405094E](#) [423220D](#) [TPCC8103,L1Q\(CM](#)
[MIC4420CM-TR](#) [VN1206L](#) [614234A](#) [715780A](#) [NTNS3166NZT5G](#) [SSM6J414TU,LF\(T](#) [751625C](#) [BUK954R8-60E](#) [GROUP A 5962-](#)
[8877003PA](#) [NTE6400](#) [SQJ402EP-T1-GE3](#) [2SK2614\(TE16L1,Q\)](#) [2N7002KW-FAI](#) [DMN1017UCP3-7](#) [EFC2J004NUZTDG](#) [ECH8691-TL-W](#)
[FCAB21350L1](#) [P85W28HP2F-7071](#) [DMN1053UCP4-7](#) [NTE221](#) [NTE222](#) [NTE2384](#) [NTE2903](#) [NTE2941](#) [NTE2945](#) [NTE2946](#) [NTE2960](#)
[NTE2967](#) [NTE2969](#) [NTE2976](#) [NTE6400A](#) [NTE2910](#) [NTE2916](#) [NTE2956](#) [NTE2911](#) [DMN2080UCB4-7](#) [TK10A80W,S4X\(S](#)
[SSM6P69NU,LF](#) [DMP22D4UFO-7B](#) [DMN1006UCA6-7](#)