

$V_{DS}$	<b>-30</b>	<b>V</b>
$V_{GS\ max}$	<b>±20</b>	<b>V</b>
$R_{DS(on)\ max}$ (@ $V_{GS} = -10V$ )	<b>37</b>	<b>mΩ</b>
$Q_g$ (typical)	<b>13</b>	<b>nC</b>
$I_D$ (@ $T_C = 25^\circ C$ )	<b>-8.5</b> ②	<b>A</b>

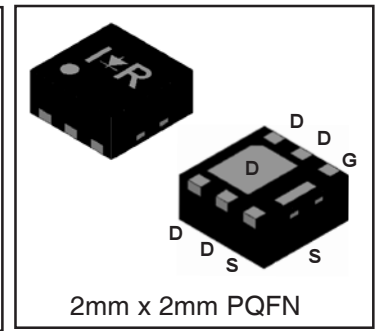
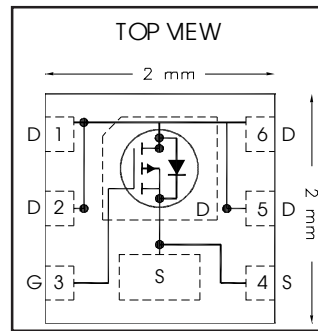

### Applications

- Charge and Discharge Switch for Battery Application
- System/load switch

### Features and Benefits

#### Features

Low $R_{DS(on)}$ ( $\leq 37m\Omega$ )
Low Thermal Resistance to PCB ( $\leq 13^\circ C/W$ )
Low Profile ( $\leq 1.0\ mm$ )
Compatible with Existing Surface Mount Techniques
RoHS Compliant Containing no Lead, no Bromide and no Halogen
MSL1, Industrial Qualification

results in

#### Benefits

Lower Conduction Losses
Enable better thermal dissipation
Increased Power Density
Easier Manufacturing
Environmentally Friendlier
Increased Reliability

Orderable part number	Package Type	Standard Pack		Note
		Form	Quantity	
IRFHS9301TRPBF	PQFN 2mm x 2mm	Tape and Reel	4000	
IRFHS9301TR2PBF	PQFN 2mm x 2mm	Tape and Reel	400	EOL notice # 259

### Absolute Maximum Ratings

	Parameter	Max.	Units
$V_{DS}$	Drain-to-Source Voltage	-30	V
$V_{GS}$	Gate-to-Source Voltage	± 20	
$I_D @ T_A = 25^\circ C$	Continuous Drain Current, $V_{GS} @ -10V$	-6.0	A
$I_D @ T_A = 70^\circ C$	Continuous Drain Current, $V_{GS} @ -10V$	-4.8	
$I_D @ T_C = 25^\circ C$	Continuous Drain Current, $V_{GS} @ -10V$	-13②	
$I_D @ T_C = 70^\circ C$	Continuous Drain Current, $V_{GS} @ -10V$	-10②	
$I_D @ T_C = 25^\circ C$	Continuous Drain Current, $V_{GS} @ 10V$ (Package Limited)	-8.5②	
$I_{DM}$	Pulsed Drain Current ①	-52	
$P_D @ T_A = 25^\circ C$	Power Dissipation ④	2.1	W
$P_D @ T_A = 70^\circ C$	Power Dissipation ④	1.3	
	Linear Derating Factor	0.02	W/°C
$T_J$	Operating Junction and	-55 to + 150	°C
$T_{STG}$	Storage Temperature Range		

Notes ① through ⑤ are on page 2

**Static @ T<sub>J</sub> = 25°C (unless otherwise specified)**

	Parameter	Min.	Typ.	Max.	Units	Conditions
BV <sub>DSS</sub>	Drain-to-Source Breakdown Voltage	-30	—	—	V	V <sub>GS</sub> = 0V, I <sub>D</sub> = -250μA
ΔBV <sub>DSS</sub> /ΔT <sub>J</sub>	Breakdown Voltage Temp. Coefficient	—	0.02	—	V/°C	Reference to 25°C, I <sub>D</sub> = -1mA
R <sub>DS(on)</sub>	Static Drain-to-Source On-Resistance	—	30	37	mΩ	V <sub>GS</sub> = -10V, I <sub>D</sub> = -7.8A ③
		—	52	65		V <sub>GS</sub> = -4.5V, I <sub>D</sub> = -6.2A ③
V <sub>GS(th)</sub>	Gate Threshold Voltage	-1.3	-1.8	-2.4	V	V <sub>DS</sub> = V <sub>GS</sub> , I <sub>D</sub> = -25μA
ΔV <sub>GS(th)</sub>	Gate Threshold Voltage Coefficient	—	-4.8	—	mV/°C	
I <sub>DSS</sub>	Drain-to-Source Leakage Current	—	—	-1.0	μA	V <sub>DS</sub> = -24V, V <sub>GS</sub> = 0V
		—	—	-150		V <sub>DS</sub> = -24V, V <sub>GS</sub> = 0V, T <sub>J</sub> = 125°C
I <sub>GSS</sub>	Gate-to-Source Forward Leakage	—	—	-100	nA	V <sub>GS</sub> = -20V
	Gate-to-Source Reverse Leakage	—	—	100		V <sub>GS</sub> = 20V
g <sub>fs</sub>	Forward Transconductance	9.3	—	—	S	V <sub>DS</sub> = -10V, I <sub>D</sub> = -7.8A
Q <sub>g</sub>	Total Gate Charge	—	6.9	—	nC	V <sub>DS</sub> = -15V, V <sub>GS</sub> = -4.5V, I <sub>D</sub> = -7.8A
Q <sub>g</sub>	Total Gate Charge	—	13	—	nC	V <sub>GS</sub> = -10V
Q <sub>gs</sub>	Gate-to-Source Charge	—	2.1	—		V <sub>DS</sub> = -15V
Q <sub>gd</sub>	Gate-to-Drain Charge	—	3.9	—		I <sub>D</sub> = -7.8A
R <sub>G</sub>	Gate Resistance	—	17	—	Ω	
t <sub>d(on)</sub>	Turn-On Delay Time	—	12	—	ns	V <sub>DD</sub> = -15V, V <sub>GS</sub> = -4.5V ③
t <sub>r</sub>	Rise Time	—	80	—		I <sub>D</sub> = -7.8A
t <sub>d(off)</sub>	Turn-Off Delay Time	—	13	—		R <sub>G</sub> = 2.0Ω
t <sub>f</sub>	Fall Time	—	25	—		See Figs. 19a & 19b
C <sub>iss</sub>	Input Capacitance	—	580	—	pF	V <sub>GS</sub> = 0V
C <sub>oss</sub>	Output Capacitance	—	125	—		V <sub>DS</sub> = -25V
C <sub>rss</sub>	Reverse Transfer Capacitance	—	79	—		f = 1.0KHz

**Diode Characteristics**

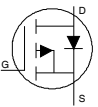
	Parameter	Min.	Typ.	Max.	Units	Conditions
I <sub>S</sub>	Continuous Source Current (Body Diode)	—	—	-8.5②	A	MOSFET symbol showing the integral reverse p-n junction diode. 
I <sub>SM</sub>	Pulsed Source Current (Body Diode) ①	—	—	-52		
V <sub>SD</sub>	Diode Forward Voltage	—	—	-1.2	V	T <sub>J</sub> = 25°C, I <sub>S</sub> = -7.8A, V <sub>GS</sub> = 0V ③
t <sub>rr</sub>	Reverse Recovery Time	—	30	45	ns	T <sub>J</sub> = 25°C, I <sub>F</sub> = -7.8A, V <sub>DD</sub> = -15V
Q <sub>rr</sub>	Reverse Recovery Charge	—	110	170	nC	di/dt = 280/μs ③

**Thermal Resistance**

	Parameter	Typ.	Max.	Units
R <sub>θJC</sub> (Bottom)	Junction-to-Case ⑤	—	13	°C/W
R <sub>θJC</sub> (Top)	Junction-to-Case ⑤	—	90	
R <sub>θJA</sub>	Junction-to-Ambient ④	—	60	
R <sub>θJA</sub>	Junction-to-Ambient (t<10s) ④	—	42	

**Notes:**

- ① Repetitive rating; pulse width limited by max. junction temperature.
- ② Current limited by package.
- ③ Pulse width ≤ 400μs; duty cycle ≤ 2%.
- ④ When mounted on 1 inch square copper board.
- ⑤ R<sub>θ</sub> is measured at T<sub>J</sub> of approximately 90°C.

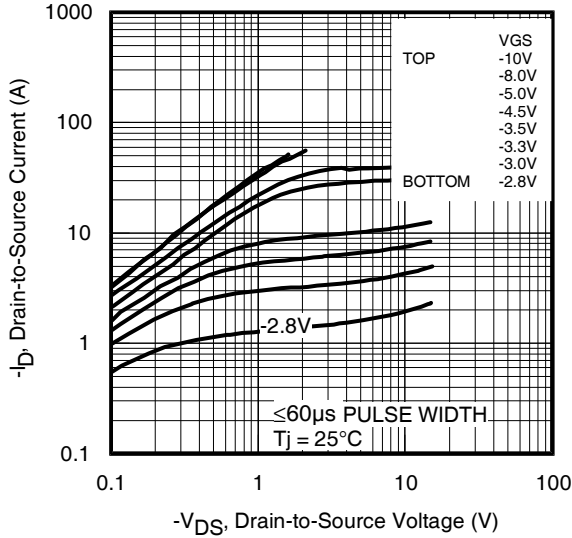
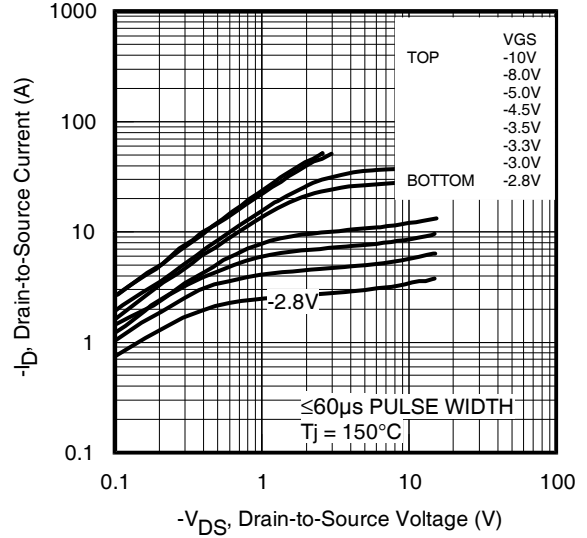
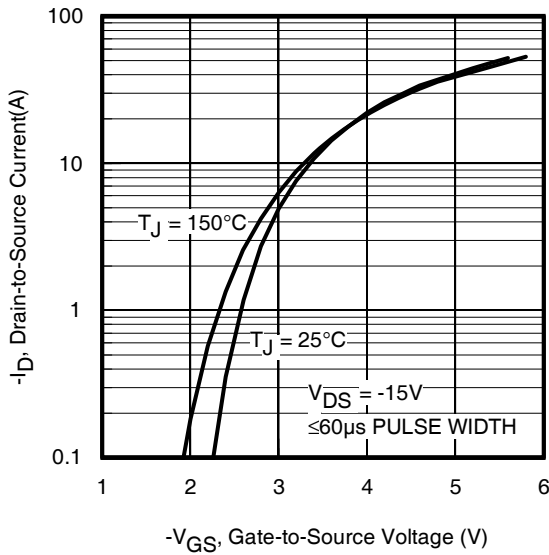
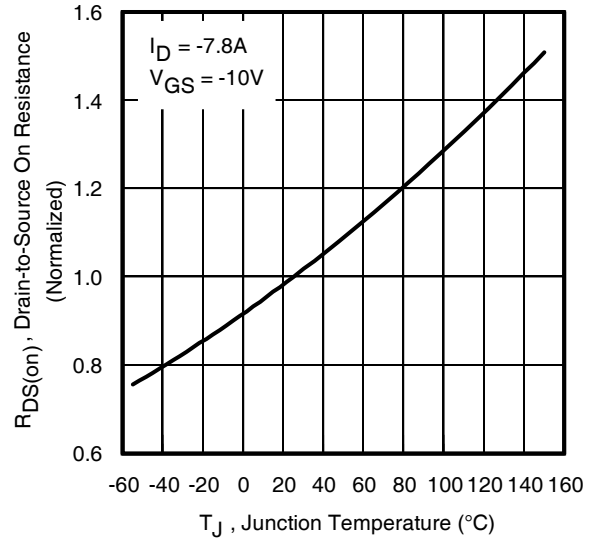
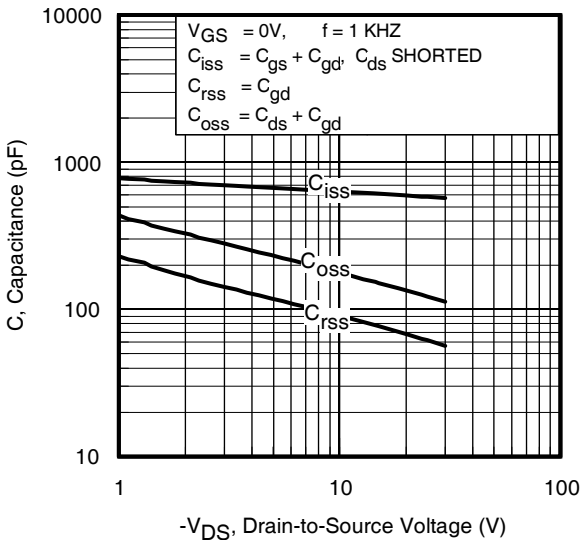
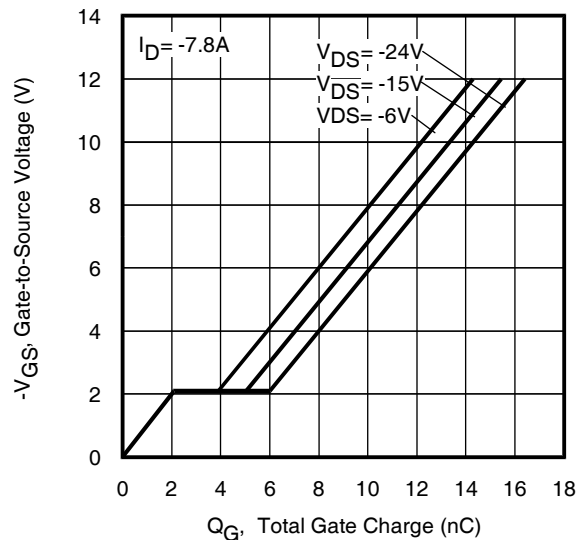
**Fig 1. Typical Output Characteristics**

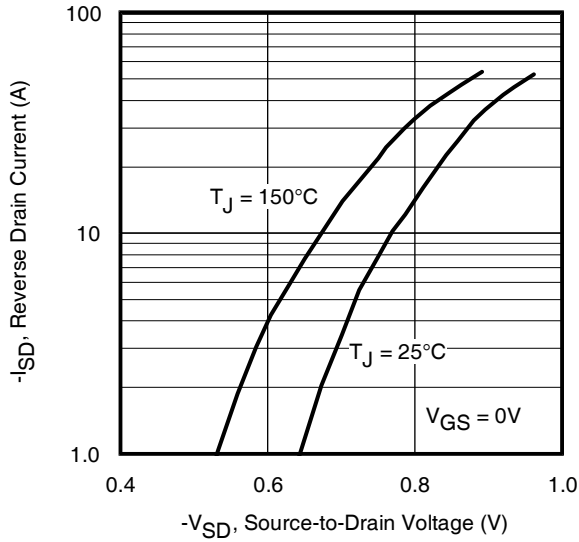
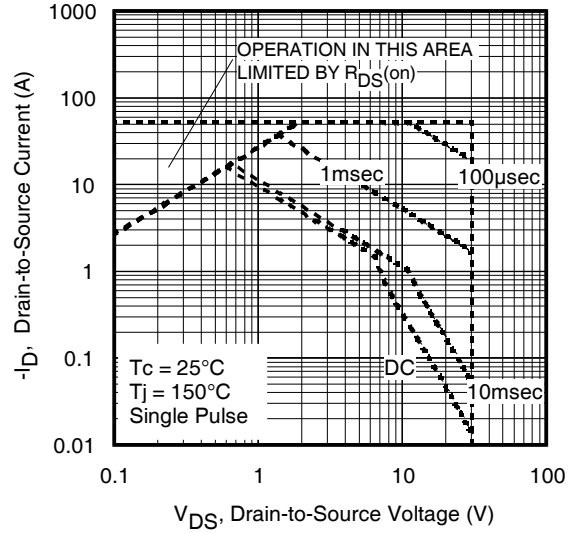
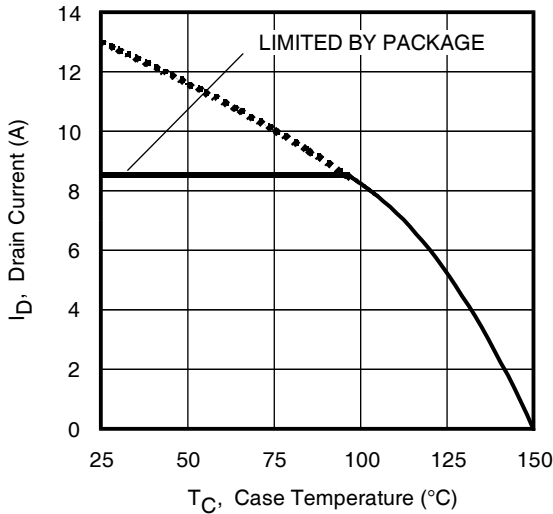
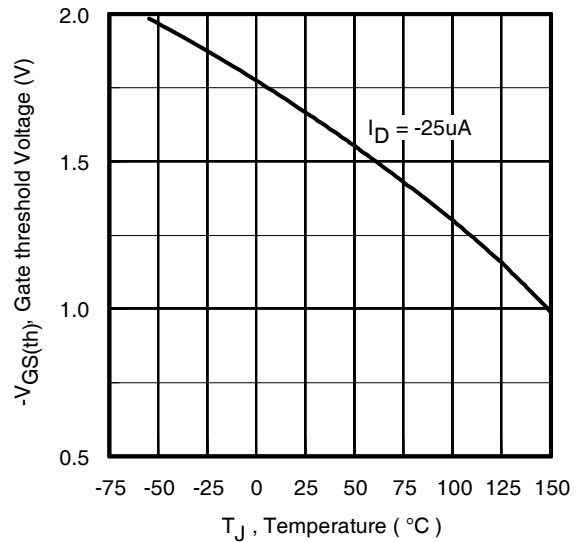
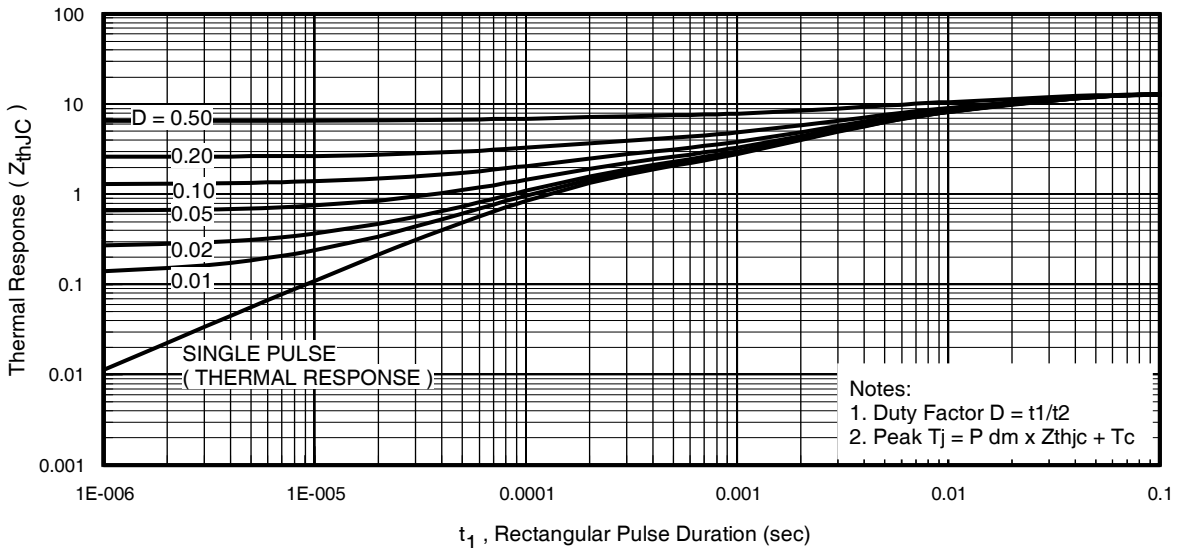
**Fig 2. Typical Output Characteristics**

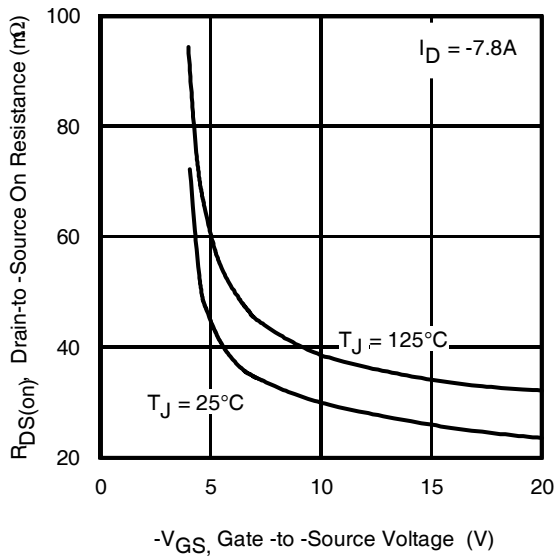
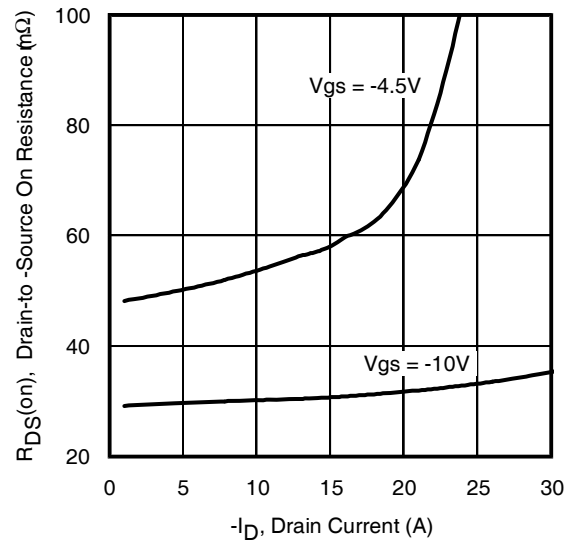
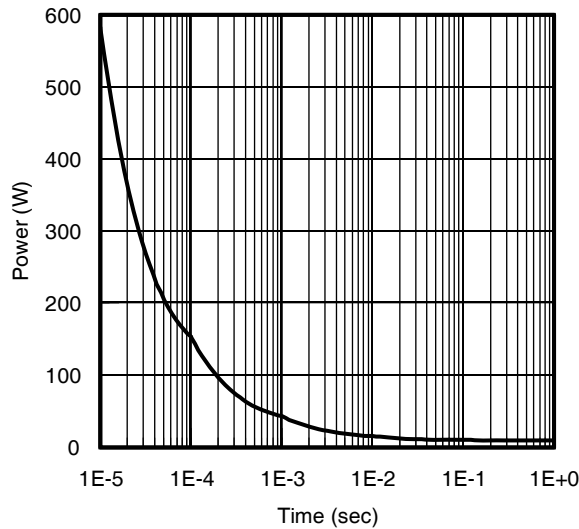
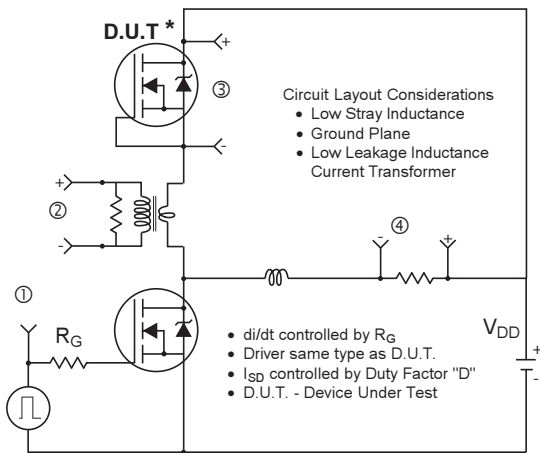
**Fig 3. Typical Transfer Characteristics**

**Fig 4. Normalized On-Resistance vs. Temperature**

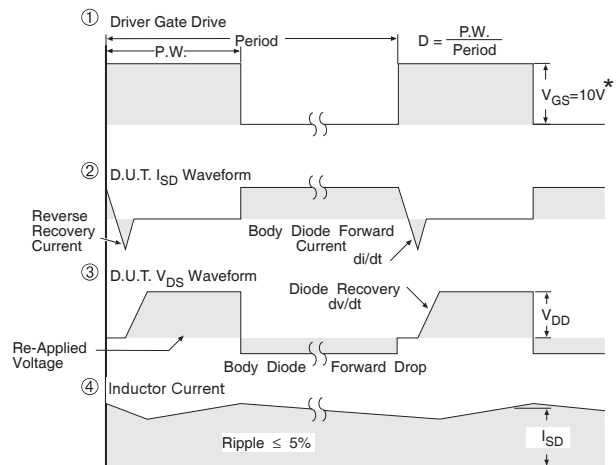
**Fig 5. Typical Capacitance vs. Drain-to-Source Voltage**

**Fig 6. Typical Gate Charge vs. Gate-to-Source Voltage**

**Fig 7.** Typical Source-Drain Diode Forward Voltage

**Fig 8.** Maximum Safe Operating Area

**Fig 9.** Maximum Drain Current vs. Case Temperature

**Fig 10.** Threshold Voltage vs. Temperature

**Fig 11.** Maximum Effective Transient Thermal Impedance, Junction-to-Case

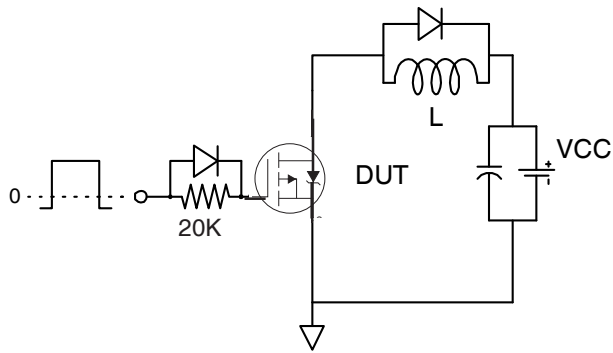
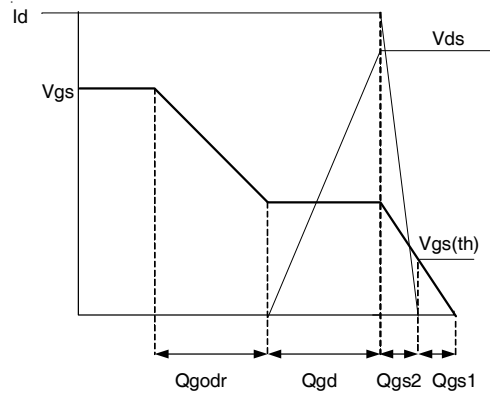
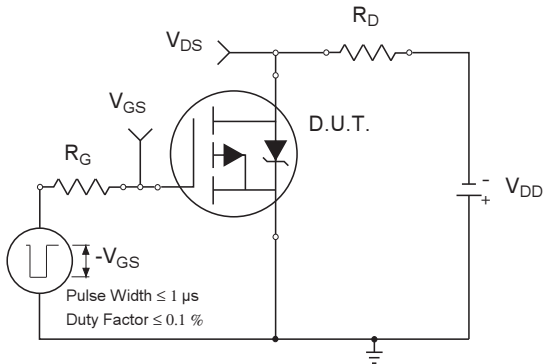
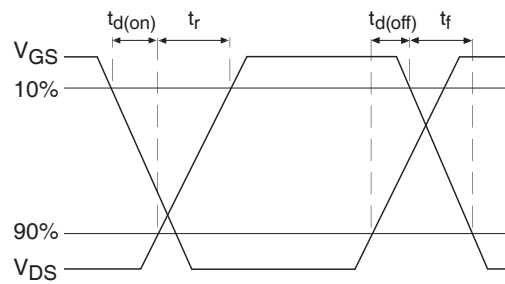

**Fig 12.** On-Resistance vs. Gate Voltage

**Fig 13.** Typical On-Resistance vs. Drain Current

**Fig 14.** Typical Power vs. Time

\* Reverse Polarity of D.U.T for P-Channel



\*  $V_{GS} = 5V$  for Logic Level Devices

**Fig 15.** Diode Reverse Recovery Test Circuit for P-Channel HEXFET<sup>®</sup> Power MOSFETs

**Fig 16a. Gate Charge Test Circuit**

**Fig 16b. Gate Charge Waveform**

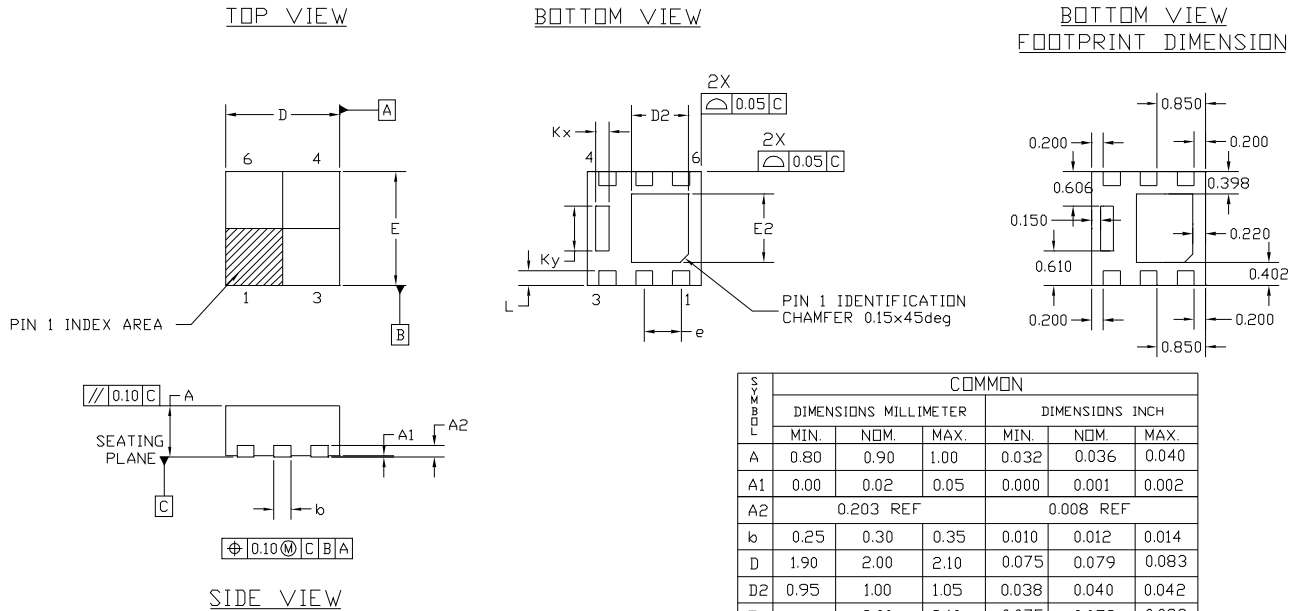
**Fig 17a. Switching Time Test Circuit**

**Fig 17b. Switching Time Waveforms**

## PQFN Package Details



NOTES :

1. DIMENSION AND TOLERANCING CONFORM TO ASME Y14.5M-1994.
2. CONTROLLING DIMENSIONS : MILLIMETER
3. DIMENSION *b* APPLIES TO METALLIZED TERMINAL AND IS MEASURED BETWEEN 0.15 AND 0.30 mm. FROM TERMINAL TIP.

## PQFN Part Marking

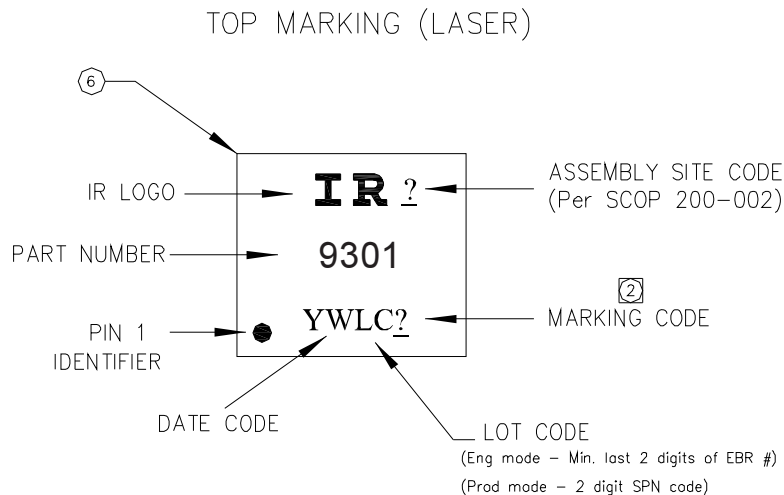

Note: For the most current drawing please refer to IR website at: <http://www.irf.com/package/>

# PQFN Tape and Reel

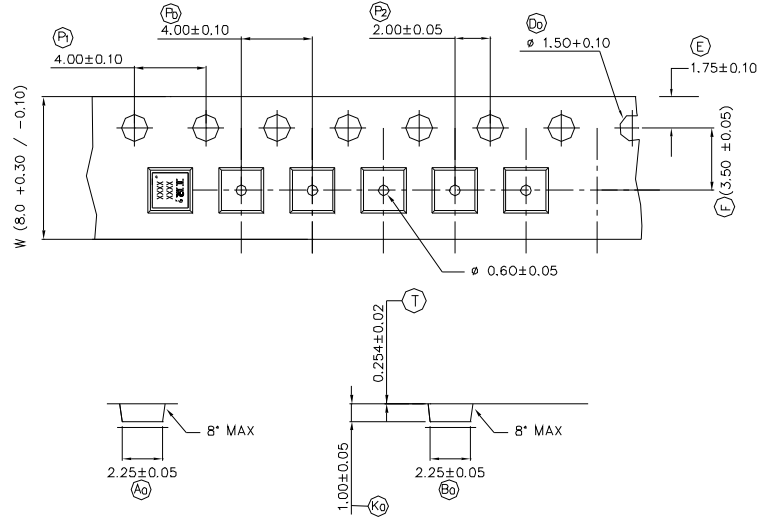

NOTE: The Surface Resistivity is  $10^4 - 10^8$  OHM/SQ

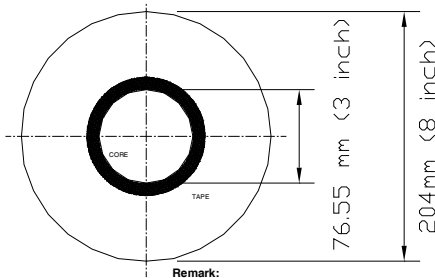
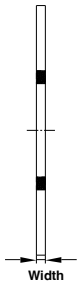

**Remark:**  
 - Dimension above are typical dimensions.  
 - Cover tape thickness is 0.048mm +/- 0.005mm.  
 - Surface resistivity  $10E5 < R_s < 10E9$ .

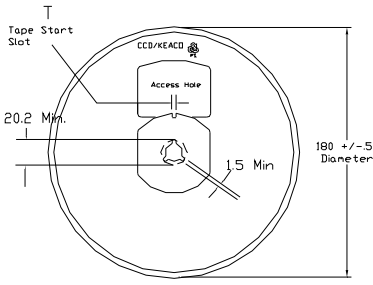

FRONT VIEW

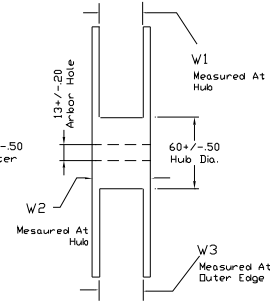

SIDE VIEW

COVER TAPE (WIDTH)	TOLERANCE
5.4 mm	+/- 0.1 mm
9.5 mm	+/- 0.1 mm

TAPE WIDTH	T	W1	W2	W3	PART NO
8 MM	3 ± 0.50	84 <sup>+1.5</sup> <sub>-3.0</sub>	14.4 Max	7.50 Min 10.9 Max	91586-1
12 MM	5 ± 0.50	12.4 <sup>+2.0</sup> <sub>-0.0</sub>	18.4 Max	11.9 Min 15.4 Max	91586-2

Note: Surface resistivity is  $\geq 1 \times 10^5$  but  $< 1 \times 10^{12}$  ohm/sq.

Note: For the most current drawing please refer to IR website at: <http://www.irf.com/package/>



**Qualification information<sup>†</sup>**

Qualification level	Industrial <sup>††</sup> (per JEDEC JESD47F <sup>†††</sup> guidelines )	
Moisture Sensitivity Level	PQFN 2mm x 2mm	MSL1 (per IPC/JEDEC J-STD-020D <sup>†††</sup> )
RoHS compliant	Yes	

† Qualification standards can be found at International Rectifier's web site

<http://www.irf.com/product-info/reliability>

†† Higher qualification ratings may be available should the user have such requirements.

Please contact your International Rectifier sales representative for further information:

<http://www.irf.com/whoto-call/salesrep/>

††† Applicable version of JEDEC standard at the time of product release.

**Revision History**

Date	Comment
5/12/2014	<ul style="list-style-type: none"> <li>• Updated ordering information to reflect the End-Of-life (EOL) of the mini-reel option (EOL notice #259)</li> <li>• Updated data sheet based on corporate template.</li> </ul>
5/21/2014	<ul style="list-style-type: none"> <li>• Updated qual level from "Consumer" to "Industrial" on page 1 &amp; 9.</li> </ul>

## **IMPORTANT NOTICE**

The information given in this document shall in no event be regarded as a guarantee of conditions or characteristics ("Beschaffheitsgarantie").

With respect to any examples, hints or any typical values stated herein and/or any information regarding the application of the product, Infineon Technologies hereby disclaims any and all warranties and liabilities of any kind, including without limitation warranties of non-infringement of intellectual property rights of any third party.

In addition, any information given in this document is subject to customer's compliance with its obligations stated in this document and any applicable legal requirements, norms and standards concerning customer's products and any use of the product of Infineon Technologies in customer's applications.

The data contained in this document is exclusively intended for technically trained staff. It is the responsibility of customer's technical departments to evaluate the suitability of the product for the intended application and the completeness of the product information given in this document with respect to such application.

For further information on the product, technology, delivery terms and conditions and prices please contact your nearest Infineon Technologies office ([www.infineon.com](http://www.infineon.com)).

## **WARNINGS**

Due to technical requirements products may contain dangerous substances. For information on the types in question please contact your nearest Infineon Technologies office.

Except as otherwise explicitly approved by Infineon Technologies in a written document signed by authorized representatives of Infineon Technologies, Infineon Technologies' products may not be used in any applications where a failure of the product or any consequences of the use thereof can reasonably be expected to result in personal injury.

## X-ON Electronics

Largest Supplier of Electrical and Electronic Components

*Click to view similar products for [MOSFET](#) category:*

*Click to view products by [Infineon](#) manufacturer:*

Other Similar products are found below :

[614233C](#) [648584F](#) [IRFD120](#) [JANTX2N5237](#) [FCA20N60\\_F109](#) [FDZ595PZ](#) [2SK2545\(Q,T\)](#) [405094E](#) [423220D](#) [TPCC8103,L1Q\(CM](#)  
[MIC4420CM-TR](#) [VN1206L](#) [SBVS138LT1G](#) [614234A](#) [715780A](#) [NTNS3166NZT5G](#) [SSM6J414TU,LF\(T](#) [751625C](#) [BUK954R8-60E](#)  
[NTE6400](#) [SQJ402EP-T1-GE3](#) [2SK2614\(TE16L1,Q\)](#) [2N7002KW-FAI](#) [DMN1017UCP3-7](#) [EFC2J004NUZTDG](#) [ECH8691-TL-W](#)  
[FCAB21350L1](#) [P85W28HP2F-7071](#) [DMN1053UCP4-7](#) [NTE221](#) [NTE222](#) [NTE2384](#) [NTE2903](#) [NTE2941](#) [NTE2945](#) [NTE2946](#) [NTE2960](#)  
[NTE2967](#) [NTE2969](#) [NTE2976](#) [NTE455](#) [NTE6400A](#) [NTE2910](#) [NTE2916](#) [NTE2956](#) [NTE2911](#) [DMN2080UCB4-7](#) [TK10A80W,S4X\(S](#)  
[SSM6P69NU,LF](#) [DMP22D4UFO-7B](#)