

# IRFP3710PbF

HEXFET® Power MOSFET

- Advanced Process Technology
- Dynamic dv/dt Rating
- 175°C Operating Temperature
- Fast Switching
- Fully Avalanche Rated
- Lead-Free

## Description

Fifth Generation HEXFETs from International Rectifier utilize advanced processing techniques to achieve extremely low on-resistance per silicon area. This benefit, combined with the fast switching speed and ruggedized device design that HEXFET Power MOSFETs are well known for, provides the designer with an extremely efficient and reliable device for use in a wide variety of applications.

The TO-247AC package is universally preferred for all commercial-industrial applications at power dissipation levels to approximately 50 watts. The low thermal resistance and low package cost of the TO-247AC contribute to its wide acceptance throughout the industry.

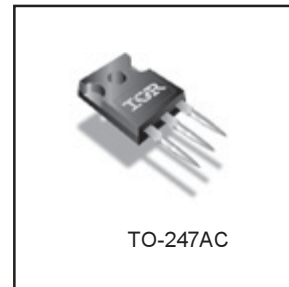
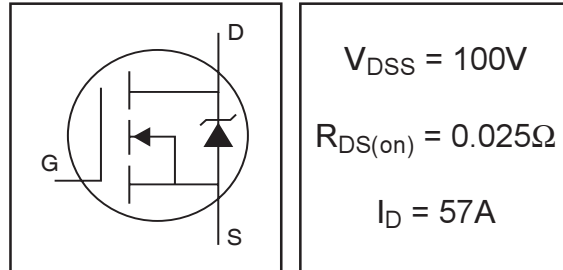

## Absolute Maximum Ratings

|                                 | Parameter                                       | Max.               | Units |
|---------------------------------|---|--------------------|-------|
| $I_D @ T_C = 25^\circ\text{C}$  | Continuous Drain Current, $V_{GS} @ 10\text{V}$ | 57                 | A     |
| $I_D @ T_C = 100^\circ\text{C}$ | Continuous Drain Current, $V_{GS} @ 10\text{V}$ | 40                 |       |
| $I_{DM}$                        | Pulsed Drain Current ①                          | 180                |       |
| $P_D @ T_C = 25^\circ\text{C}$  | Power Dissipation                               | 200                | W     |
|                                 | Linear Derating Factor                          | 1.3                | W/°C  |
| $V_{GS}$                        | Gate-to-Source Voltage                          | $\pm 20$           | V     |
| $E_{AS}$                        | Single Pulse Avalanche Energy②                  | 530                | mJ    |
| $I_{AR}$                        | Avalanche Current①                              | 28                 | A     |
| $E_{AR}$                        | Repetitive Avalanche Energy①                    | 20                 | mJ    |
| dv/dt                           | Peak Diode Recovery dv/dt ③                     | 5.0                | V/ns  |
| $T_J$                           | Operating Junction and                          | -55 to + 175       | °C    |
| $T_{STG}$                       | Storage Temperature Range                       |                    |       |
|                                 | Soldering Temperature, for 10 seconds           |                    |       |
|                                 | Mounting torque, 6-32 or M3 srew                | 10 lbf•in (1.1N•m) |       |

## Thermal Resistance

|                 | Parameter                           | Typ. | Max. | Units |
|-----------------|-------------------------------------|------|------|-------|
| $R_{\theta JC}$ | Junction-to-Case                    | ---  | 0.75 | °C/W  |
| $R_{\theta CS}$ | Case-to-Sink, Flat, Greased Surface | 0.50 | ---  |       |
| $R_{\theta JA}$ | Junction-to-Ambient                 | ---  | 62   |       |

# IRFP3710PbF

International  
**IR** Rectifier

## Electrical Characteristics @ $T_J = 25^\circ\text{C}$ (unless otherwise specified)

|                                 | Parameter                            | Min. | Typ. | Max.  | Units    | Conditions  |
|---------------------------------|--------------------------------------|------|------|-------|----------|---|
| $V_{(BR)DSS}$                   | Drain-to-Source Breakdown Voltage    | 100  | —    | —     | V        | $V_{GS} = 0V, I_D = 250\mu A$   |
| $\Delta V_{(BR)DSS}/\Delta T_J$ | Breakdown Voltage Temp. Coefficient  | —    | 0.12 | —     | V/°C     | Reference to $25^\circ\text{C}, I_D = 1\text{mA}$                           |
| $R_{DS(on)}$                    | Static Drain-to-Source On-Resistance | —    | —    | 0.025 | $\Omega$ | $V_{GS} = 10V, I_D = 28A$ ④   |
| $V_{GS(th)}$                    | Gate Threshold Voltage               | 2.0  | —    | 4.0   | V        | $V_{DS} = V_{GS}, I_D = 250\mu A$   |
| $g_{fs}$                        | Forward Transconductance             | 20   | —    | —     | S        | $V_{DS} = 25V, I_D = 28A$   |
| $I_{DSS}$                       | Drain-to-Source Leakage Current      | —    | —    | 25    | $\mu A$  | $V_{DS} = 100V, V_{GS} = 0V$  |
|                                 |                                      | —    | —    | 250   |          | $V_{DS} = 80V, V_{GS} = 0V, T_J = 150^\circ\text{C}$                        |
| $I_{GSS}$                       | Gate-to-Source Forward Leakage       | —    | —    | 100   | nA       | $V_{GS} = 20V$  |
|                                 | Gate-to-Source Reverse Leakage       | —    | —    | -100  |          | $V_{GS} = -20V$   |
| $Q_g$                           | Total Gate Charge                    | —    | —    | 190   | nC       | $I_D = 28A$   |
| $Q_{gs}$                        | Gate-to-Source Charge                | —    | —    | 26    |          | $V_{DS} = 80V$  |
| $Q_{gd}$                        | Gate-to-Drain ("Miller") Charge      | —    | —    | 82    |          | $V_{GS} = 10V, \text{See Fig. 6 and 13 } \textcircled{4}$                   |
| $t_{d(on)}$                     | Turn-On Delay Time                   | —    | 14   | —     |          | $V_{DD} = 50V$  |
| $t_r$                           | Rise Time                            | —    | 59   | —     | ns       | $I_D = 28A$   |
| $t_{d(off)}$                    | Turn-Off Delay Time                  | —    | 58   | —     |          | $R_G = 2.5\Omega$   |
| $t_f$                           | Fall Time                            | —    | 48   | —     |          | $R_D = 1.7\Omega, \text{See Fig. 10 } \textcircled{4}$                      |
| $L_D$                           | Internal Drain Inductance            | —    | 4.5  | —     | nH       | Between lead,<br>6mm (0.25in.)<br>from package<br>and center of die contact |
| $L_S$                           | Internal Source Inductance           | —    | 7.5  | —     |          |   |
| $C_{iss}$                       | Input Capacitance                    | —    | 3000 | —     | pF       | $V_{GS} = 0V$   |
| $C_{oss}$                       | Output Capacitance                   | —    | 640  | —     |          | $V_{DS} = 25V$  |
| $C_{riss}$                      | Reverse Transfer Capacitance         | —    | 330  | —     |          | $f = 1.0\text{MHz}, \text{See Fig. 5}$                                      |

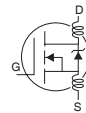

## Source-Drain Ratings and Characteristics

|          | Parameter                                 | Min.  | Typ. | Max. | Units   | Conditions  |
|----------|---|---|------|------|---------|---|
| $I_S$    | Continuous Source Current<br>(Body Diode) | —   | —    | 57   | A       | MOSFET symbol<br>showing the<br>integral reverse<br>p-n junction diode. |
| $I_{SM}$ | Pulsed Source Current<br>(Body Diode) ①   | —   | —    | 180  |         |   |
| $V_{SD}$ | Diode Forward Voltage                     | —   | —    | 1.3  | V       | $T_J = 25^\circ\text{C}, I_S = 28A, V_{GS} = 0V$ ④                      |
| $t_{rr}$ | Reverse Recovery Time                     | —   | 210  | 320  | ns      | $T_J = 25^\circ\text{C}, I_F = 28A$                                     |
| $Q_{rr}$ | Reverse Recovery Charge                   | —   | 1.7  | 2.6  | $\mu C$ | $di/dt = 100A/\mu s$ ④  |
| $t_{on}$ | Forward Turn-On Time                      | Intrinsic turn-on time is negligible (turn-on is dominated by $L_S + L_D$ ) |      |      |         |   |

### Notes:

① Repetitive rating; pulse width limited by max. junction temperature. ( See fig. 11 )

② Starting  $T_J = 25^\circ\text{C}, L = 1.4\text{mH}$   
 $R_G = 25\Omega, I_{AS} = 28A.$  (See Figure 12)

③  $I_{SD} \leq 28A, di/dt \leq 460A/\mu s, V_{DD} \leq V_{(BR)DSS},$   
 $T_J \leq 175^\circ\text{C}$

④ Pulse width  $\leq 300\mu s;$  duty cycle  $\leq 2\%.$

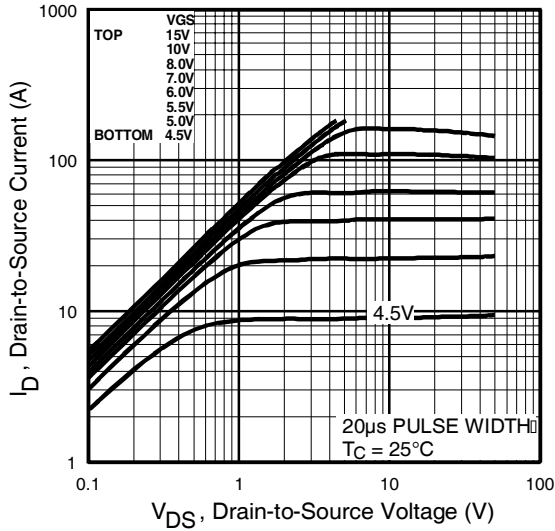

**Fig 1.** Typical Output Characteristics

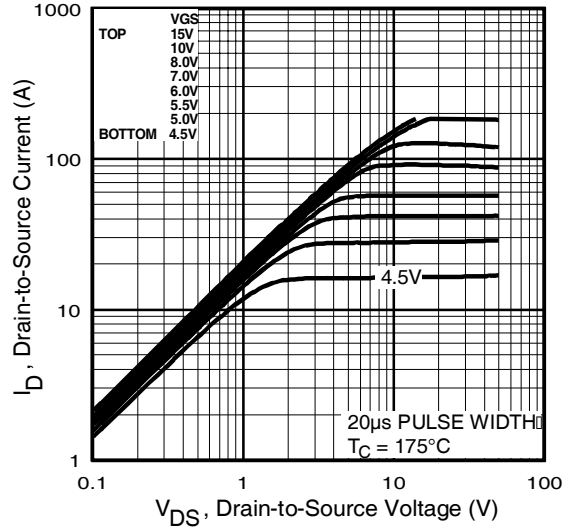

**Fig 2.** Typical Output Characteristics

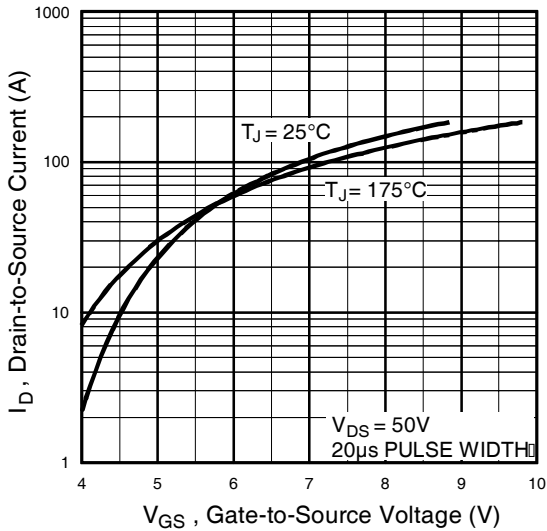

**Fig 3.** Typical Transfer Characteristics

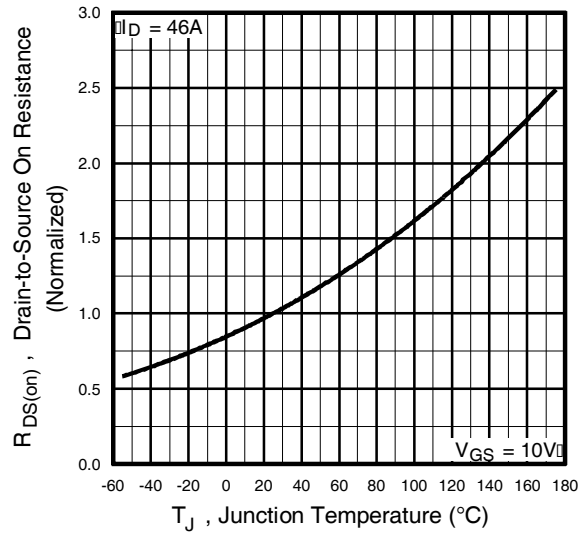

**Fig 4.** Normalized On-Resistance Vs. Temperature

# IRFP3710PbF

International  
**IR** Rectifier

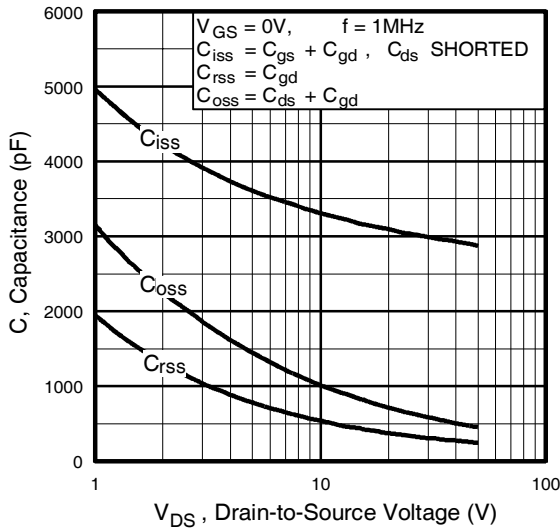

**Fig 5.** Typical Capacitance Vs. Drain-to-Source Voltage

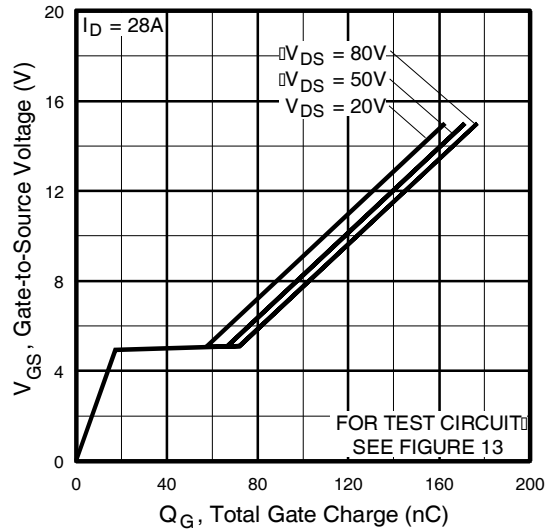

**Fig 6.** Typical Gate Charge Vs. Gate-to-Source Voltage

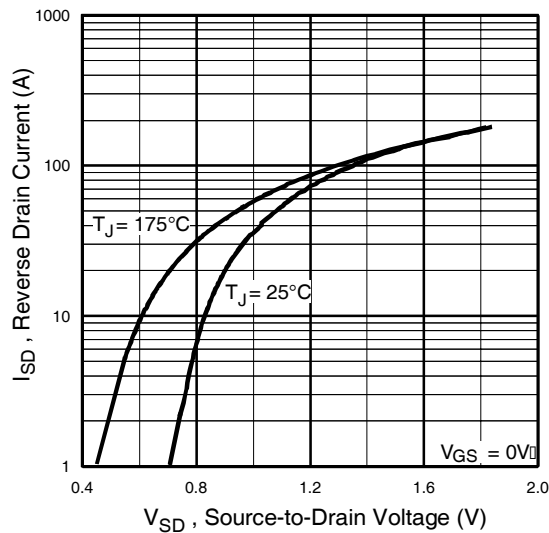

**Fig 7.** Typical Source-Drain Diode Forward Voltage

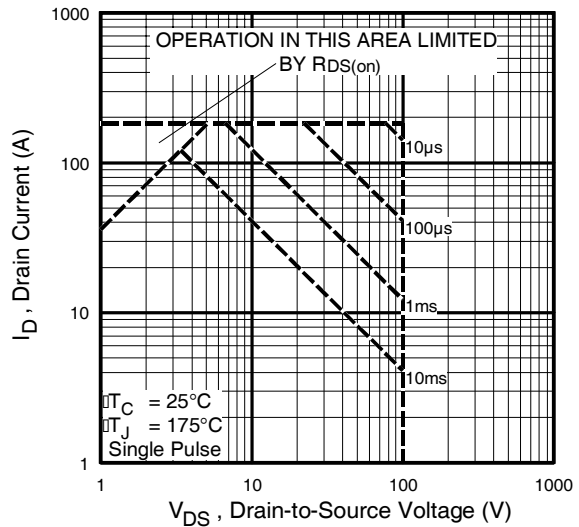

**Fig 8.** Maximum Safe Operating Area

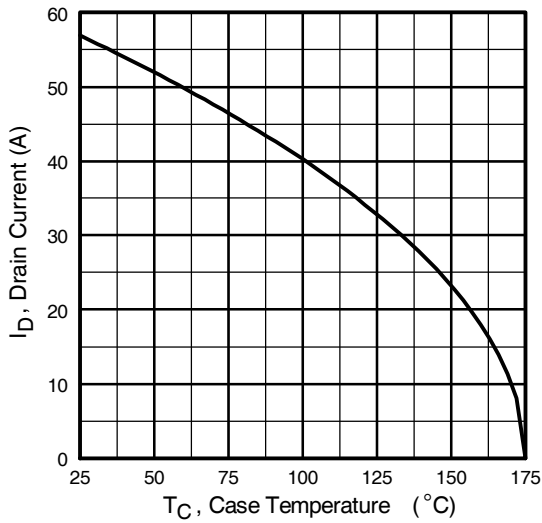

**Fig 9.** Maximum Drain Current Vs. Case Temperature



**Fig 10a.** Switching Time Test Circuit



**Fig 10b.** Switching Time Waveforms

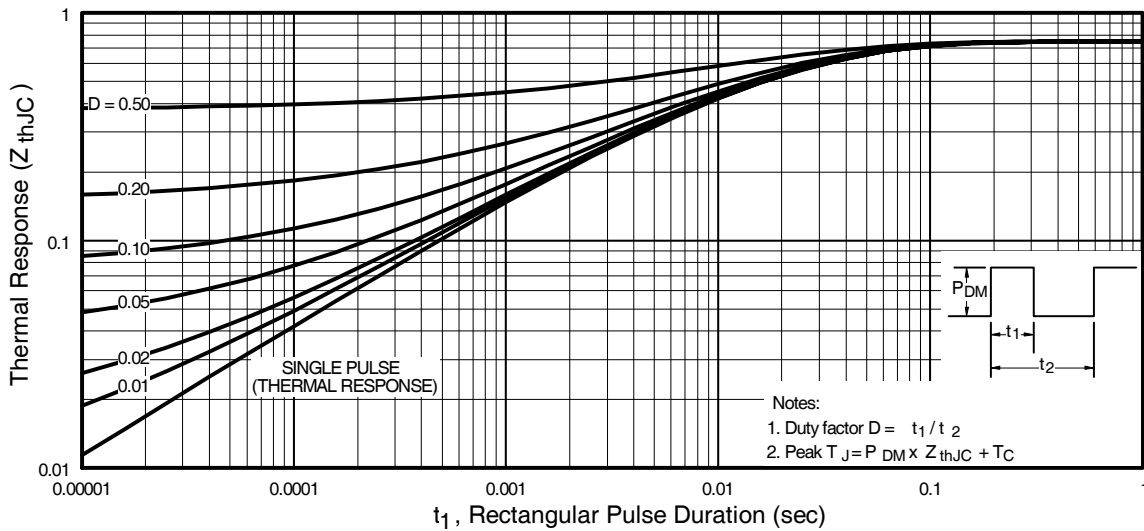

**Fig 11.** Maximum Effective Transient Thermal Impedance, Junction-to-Case

# IRFP3710PbF

International  
**IOR** Rectifier

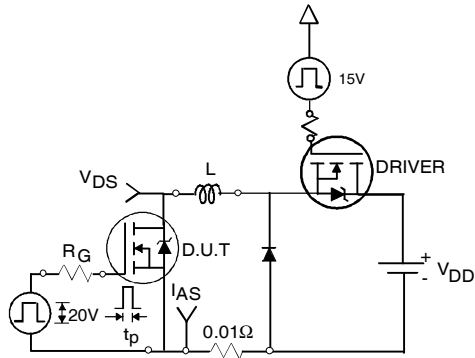

**Fig 12a.** Unclamped Inductive Test Circuit



**Fig 12b.** Unclamped Inductive Waveforms



**Fig 13a.** Basic Gate Charge Waveform

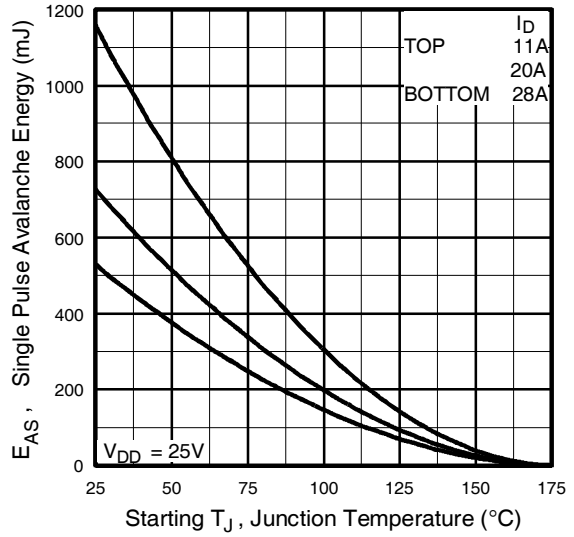

**Fig 12c.** Maximum Avalanche Energy Vs. Drain Current

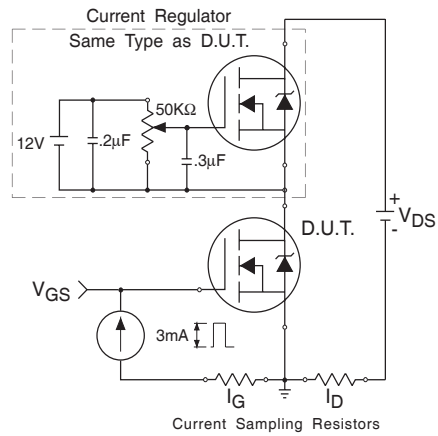

**Fig 13b.** Gate Charge Test Circuit

## Peak Diode Recovery dv/dt Test Circuit



\*  $V_{GS} = 5V$  for Logic Level Devices

**Fig 14.** For N-Channel HEXFETS

# IRFP3710PbF

International  
**IR** Rectifier

## TO-247AC Package Outline

Dimensions are shown in millimeters (inches)

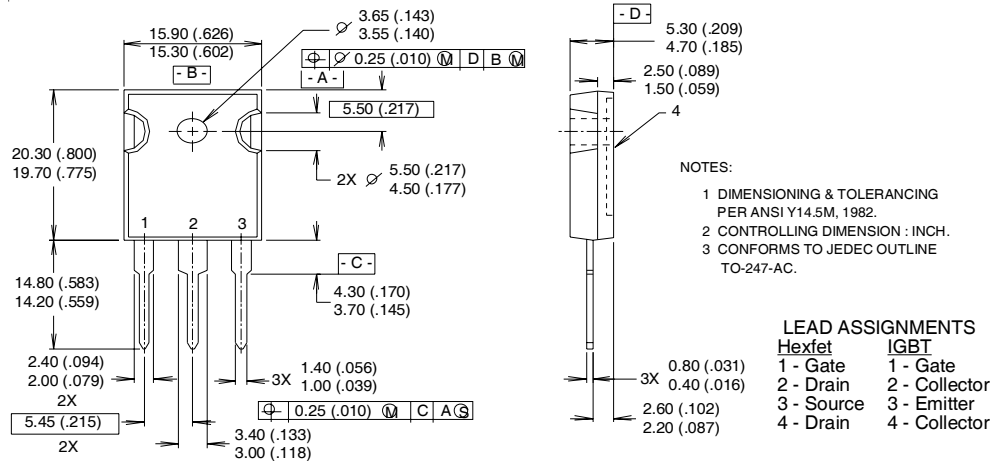

## TO-247AC Part Marking Information

EXAMPLE: THIS IS AN IRFP30  
WITH ASSEMBLY  
LOT CODE 5657  
ASSEMBLED ON WW 35, 2000  
IN THE ASSEMBLY LINE "H"  
**Note:** "P" in assembly line  
position indicates "Lead-Free"

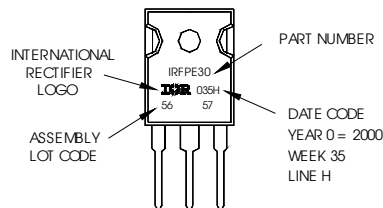

Data and specifications subject to change without notice.

International  
**IR** Rectifier

IR WORLD HEADQUARTERS: 233 Kansas St., El Segundo, California 90245, USA Tel: (310) 252-7105  
TAC Fax: (310) 252-7903

Visit us at [www.irf.com](http://www.irf.com) for sales contact information.05/05



Note: For the most current drawings please refer to the IR website at:  
<http://www.irf.com/package/>

## **IMPORTANT NOTICE**

The information given in this document shall in no event be regarded as a guarantee of conditions or characteristics ("Beschaffheitsgarantie").

With respect to any examples, hints or any typical values stated herein and/or any information regarding the application of the product, Infineon Technologies hereby disclaims any and all warranties and liabilities of any kind, including without limitation warranties of non-infringement of intellectual property rights of any third party.

In addition, any information given in this document is subject to customer's compliance with its obligations stated in this document and any applicable legal requirements, norms and standards concerning customer's products and any use of the product of Infineon Technologies in customer's applications.

The data contained in this document is exclusively intended for technically trained staff. It is the responsibility of customer's technical departments to evaluate the suitability of the product for the intended application and the completeness of the product information given in this document with respect to such application.

For further information on the product, technology, delivery terms and conditions and prices please contact your nearest Infineon Technologies office ([www.infineon.com](http://www.infineon.com)).

## **WARNINGS**

Due to technical requirements products may contain dangerous substances. For information on the types in question please contact your nearest Infineon Technologies office.

Except as otherwise explicitly approved by Infineon Technologies in a written document signed by authorized representatives of Infineon Technologies, Infineon Technologies' products may not be used in any applications where a failure of the product or any consequences of the use thereof can reasonably be expected to result in personal injury.

## X-ON Electronics

Largest Supplier of Electrical and Electronic Components

*Click to view similar products for [MOSFET](#) category:*

*Click to view products by [Infineon](#) manufacturer:*

Other Similar products are found below :

[614233C](#) [648584F](#) [IRFD120](#) [JANTX2N5237](#) [FCA20N60\\_F109](#) [FDZ595PZ](#) [2SK2545\(Q,T\)](#) [405094E](#) [423220D](#) [TPCC8103,L1Q\(CM](#)  
[MIC4420CM-TR](#) [VN1206L](#) [614234A](#) [715780A](#) [NTNS3166NZT5G](#) [SSM6J414TU,LF\(T](#) [751625C](#) [BUK954R8-60E](#) [GROUP A 5962-](#)  
[8877003PA](#) [NTE6400](#) [SQJ402EP-T1-GE3](#) [2SK2614\(TE16L1,Q\)](#) [2N7002KW-FAI](#) [DMN1017UCP3-7](#) [EFC2J004NUZTDG](#) [ECH8691-TL-W](#)  
[FCAB21350L1](#) [P85W28HP2F-7071](#) [DMN1053UCP4-7](#) [NTE221](#) [NTE222](#) [NTE2384](#) [NTE2903](#) [NTE2941](#) [NTE2945](#) [NTE2946](#) [NTE2960](#)  
[NTE2967](#) [NTE2969](#) [NTE2976](#) [NTE6400A](#) [NTE2910](#) [NTE2916](#) [NTE2956](#) [NTE2911](#) [DMN2080UCB4-7](#) [TK10A80W,S4X\(S](#)  
[SSM6P54TU,LF](#) [SSM6P69NU,LF](#) [DMP22D4UFO-7B](#)