

**Applications**

- High frequency DC-DC converters

<b>V<sub>DSS</sub></b>	<b>R<sub>DS(on)</sub> max</b>	<b>I<sub>D</sub></b>
<b>100V</b>	<b>0.025Ω</b>	<b>59A</b>

**Benefits**

- Low Gate-to-Drain Charge to Reduce Switching Losses
- Fully Characterized Capacitance Including Effective C<sub>OSS</sub> to Simplify Design, (See App. Note AN1001)
- Fully Characterized Avalanche Voltage and Current

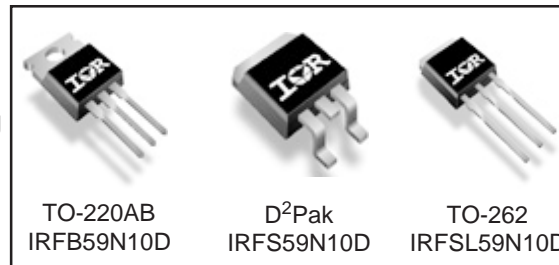

**Absolute Maximum Ratings**

	<b>Parameter</b>	<b>Max.</b>	<b>Units</b>
I <sub>D</sub> @ T <sub>C</sub> = 25°C	Continuous Drain Current, V <sub>GS</sub> @ 10V	59	A
I <sub>D</sub> @ T <sub>C</sub> = 100°C	Continuous Drain Current, V <sub>GS</sub> @ 10V	42	
I <sub>DM</sub>	Pulsed Drain Current ①	236	
P <sub>D</sub> @ T <sub>A</sub> = 25°C	Power Dissipation ②	3.8	W
P <sub>D</sub> @ T <sub>C</sub> = 25°C	Power Dissipation	200	
	Linear Derating Factor	1.3	W/°C
V <sub>GS</sub>	Gate-to-Source Voltage	± 30	V
dv/dt	Peak Diode Recovery dv/dt ③	3.3	V/ns
T <sub>J</sub>	Operating Junction and	-55 to + 175	°C
T <sub>STG</sub>	Storage Temperature Range		
	Soldering Temperature, for 10 seconds	300 (1.6mm from case )	
	Mounting torque, 6-32 or M3 screw ④	10 lbf•in (1.1N•m)	

**Typical SMPS Topologies**

- Half-bridge and Full-bridge DC-DC Converters
- Full-bridge Inverters

Notes ① through ④ are on page 11

# IRFB/IRFS/IRFSL59N10D

International  
IR Rectifier

Static @  $T_J = 25^\circ\text{C}$  (unless otherwise specified)

	Parameter	Min.	Typ.	Max.	Units	Conditions
$V_{(BR)DSS}$	Drain-to-Source Breakdown Voltage	100	—	—	V	$V_{GS} = 0V, I_D = 250\mu A$
$\Delta V_{(BR)DSS}/\Delta T_J$	Breakdown Voltage Temp. Coefficient	—	0.11	—	V/ $^\circ\text{C}$	Reference to $25^\circ\text{C}, I_D = 1\text{mA}$
$R_{DS(on)}$	Static Drain-to-Source On-Resistance	—	—	0.025	$\Omega$	$V_{GS} = 10V, I_D = 35.4A$ ④
$V_{GS(th)}$	Gate Threshold Voltage	3.0	—	5.5	V	$V_{DS} = V_{GS}, I_D = 250\mu A$
$I_{DSS}$	Drain-to-Source Leakage Current	—	—	25	$\mu A$	$V_{DS} = 100V, V_{GS} = 0V$
		—	—	250		$V_{DS} = 80V, V_{GS} = 0V, T_J = 150^\circ\text{C}$
$I_{GSS}$	Gate-to-Source Forward Leakage	—	—	100	nA	$V_{GS} = 30V$
	Gate-to-Source Reverse Leakage	—	—	-100		$V_{GS} = -30V$

Dynamic @  $T_J = 25^\circ\text{C}$  (unless otherwise specified)

	Parameter	Min.	Typ.	Max.	Units	Conditions
$g_{fs}$	Forward Transconductance	18	—	—	S	$V_{DS} = 50V, I_D = 35.4A$
$Q_g$	Total Gate Charge	—	76	114	nC	$I_D = 35.4A$
$Q_{gs}$	Gate-to-Source Charge	—	24	36		$V_{DS} = 80V$
$Q_{gd}$	Gate-to-Drain ("Miller") Charge	—	36	54		$V_{GS} = 10V, \text{④}$
$t_{d(on)}$	Turn-On Delay Time	—	16	—	ns	$V_{DD} = 50V$
$t_r$	Rise Time	—	90	—		$I_D = 35.4A$
$t_{d(off)}$	Turn-Off Delay Time	—	20	—		$R_G = 2.5\Omega$
$t_f$	Fall Time	—	12	—		$V_{GS} = 10V, \text{④}$
$C_{iss}$	Input Capacitance	—	2450	—	pF	$V_{GS} = 0V$
$C_{oss}$	Output Capacitance	—	740	—		$V_{DS} = 25V$
$C_{rss}$	Reverse Transfer Capacitance	—	190	—		$f = 1.0\text{MHz}$ ⑥
$C_{oss}$	Output Capacitance	—	3370	—		$V_{GS} = 0V, V_{DS} = 1.0V, f = 1.0\text{MHz}$
$C_{oss}$	Output Capacitance	—	390	—		$V_{GS} = 0V, V_{DS} = 80V, f = 1.0\text{MHz}$
$C_{oss \text{ eff.}}$	Effective Output Capacitance	—	690	—		$V_{GS} = 0V, V_{DS} = 0V \text{ to } 80V$ ⑤

## Avalanche Characteristics

	Parameter	Typ.	Max.	Units
$E_{AS}$	Single Pulse Avalanche Energy ②	—	510	mJ
$I_{AR}$	Avalanche Current ①	—	35.4	A
$E_{AR}$	Repetitive Avalanche Energy ①	—	20	mJ

## Thermal Resistance

	Parameter	Typ.	Max.	Units
$R_{\theta JC}$	Junction-to-Case	—	0.75	$^\circ\text{C}/\text{W}$
$R_{\theta CS}$	Case-to-Sink, Flat, Greased Surface ⑥	0.50	—	
$R_{\theta JA}$	Junction-to-Ambient ⑥	—	62	
$R_{\theta JA}$	Junction-to-Ambient ⑦	—	40	

## Diode Characteristics

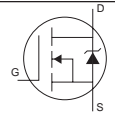
	Parameter	Min.	Typ.	Max.	Units	Conditions
$I_S$	Continuous Source Current (Body Diode)	—	—	59	A	MOSFET symbol showing the integral reverse p-n junction diode. 
$I_{SM}$	Pulsed Source Current (Body Diode) ①	—	—	236		
$V_{SD}$	Diode Forward Voltage	—	—	1.3	V	$T_J = 25^\circ\text{C}, I_S = 35.4A, V_{GS} = 0V$ ④
$t_{rr}$	Reverse Recovery Time	—	130	200	ns	$T_J = 25^\circ\text{C}, I_F = 35.4A$
$Q_{rr}$	Reverse Recovery Charge	—	0.75	1.1	$\mu\text{C}$	$di/dt = 100A/\mu\text{s}$ ④
$t_{on}$	Forward Turn-On Time	Intrinsic turn-on time is negligible (turn-on is dominated by $L_S + L_D$ )				

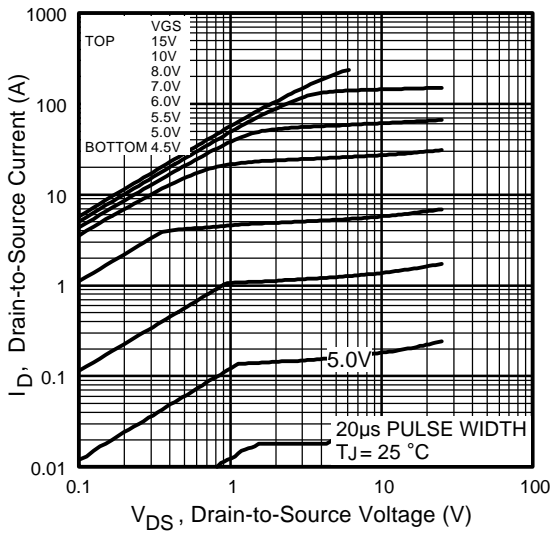

Fig 1. Typical Output Characteristics

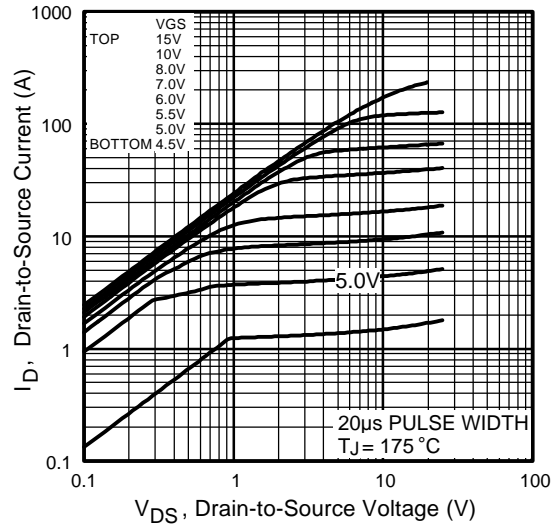

Fig 2. Typical Output Characteristics

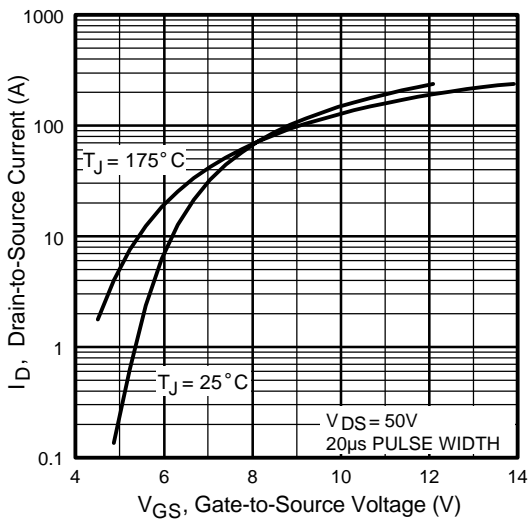

Fig 3. Typical Transfer Characteristics

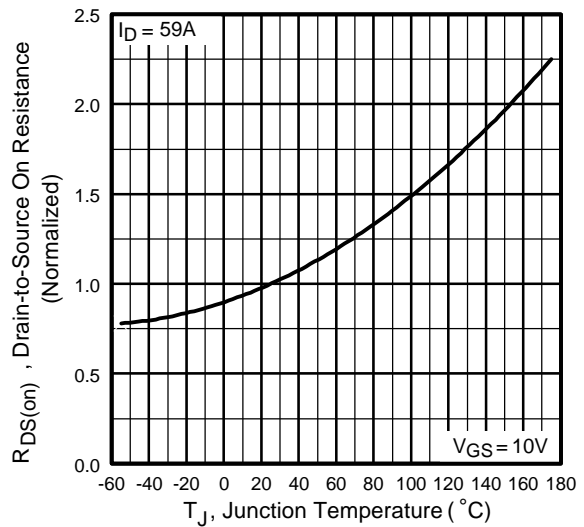
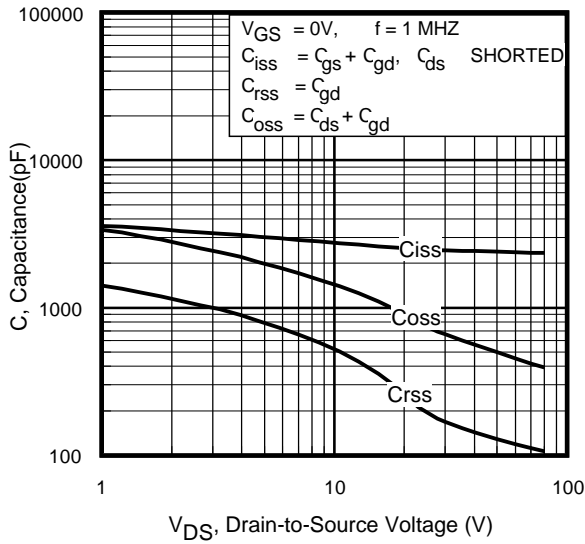
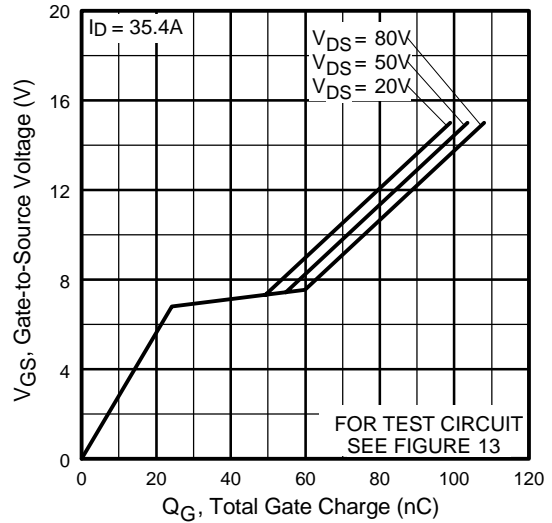

Fig 4. Normalized On-Resistance Vs. Temperature

# IRFB/IRFS/IRFSL59N10D



**Fig 5.** Typical Capacitance Vs. Drain-to-Source Voltage



**Fig 6.** Typical Gate Charge Vs. Gate-to-Source Voltage

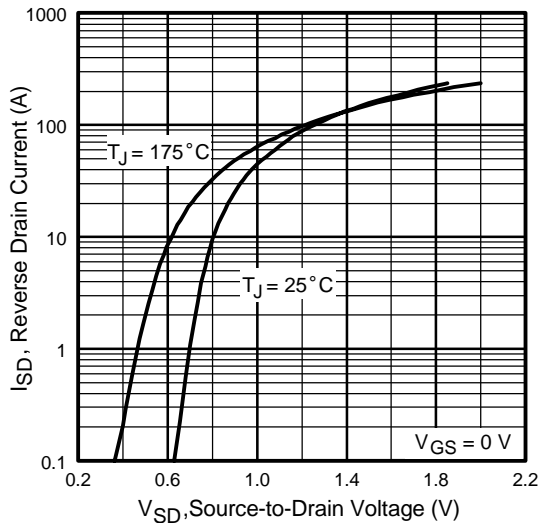

**Fig 7.** Typical Source-Drain Diode Forward Voltage

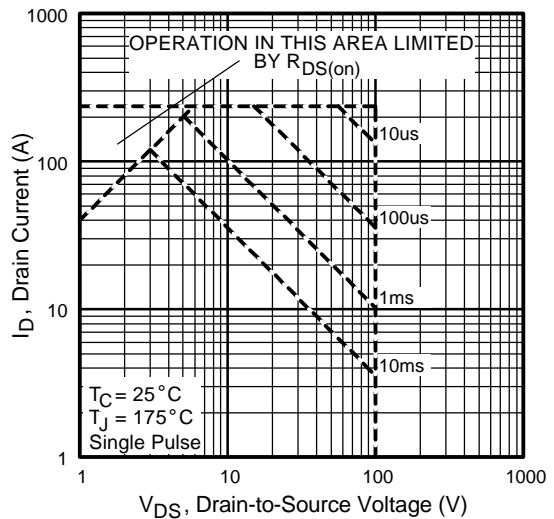

**Fig 8.** Maximum Safe Operating Area

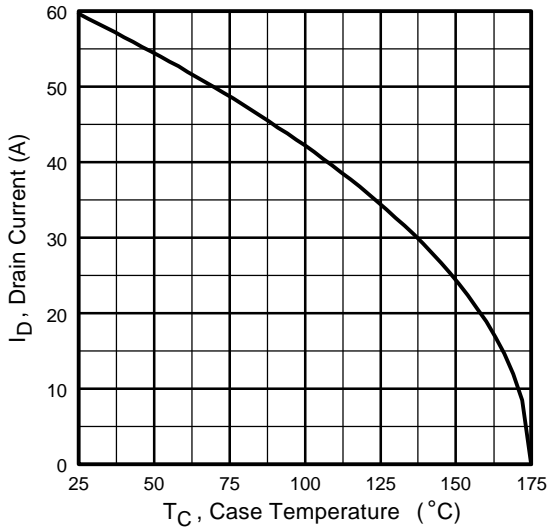

**Fig 9.** Maximum Drain Current Vs. Case Temperature

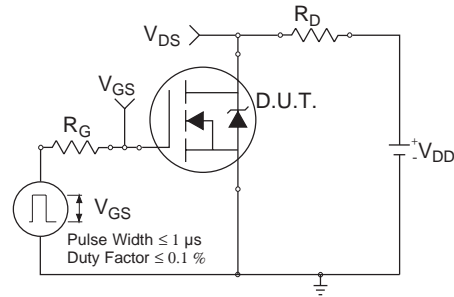

**Fig 10a.** Switching Time Test Circuit

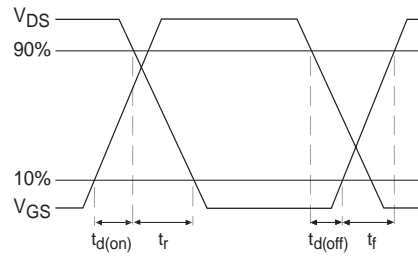

**Fig 10b.** Switching Time Waveforms

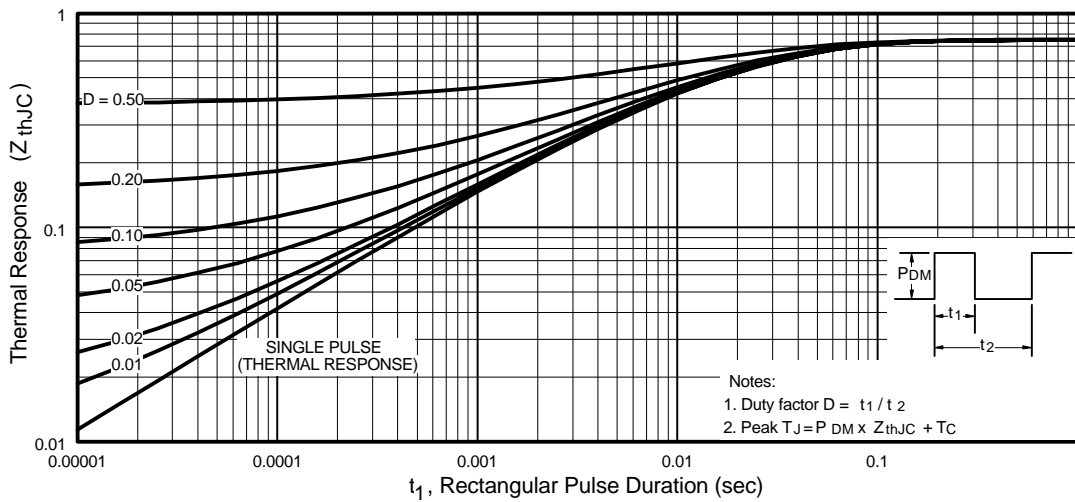

**Fig 11.** Maximum Effective Transient Thermal Impedance, Junction-to-Case

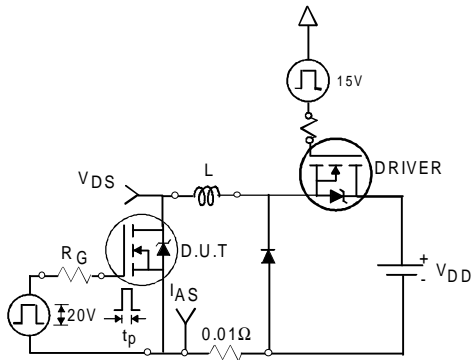

**Fig 12a.** Unclamped Inductive Test Circuit

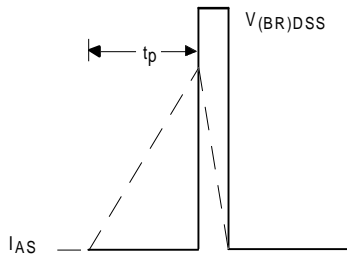

**Fig 12b.** Unclamped Inductive Waveforms

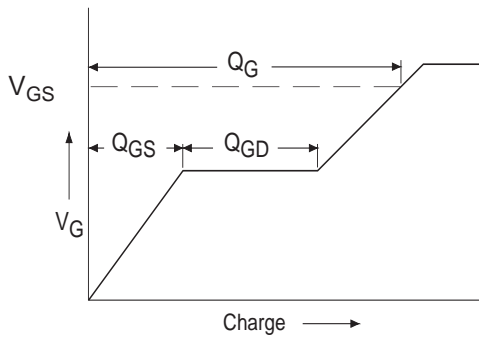

**Fig 13a.** Basic Gate Charge Waveform

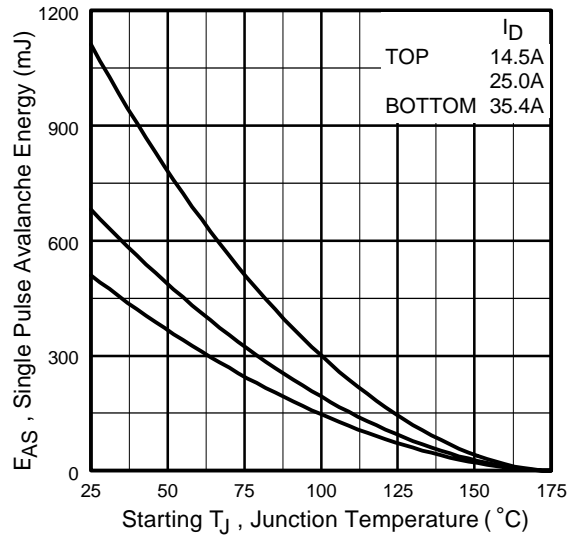

**Fig 12c.** Maximum Avalanche Energy Vs. Drain Current

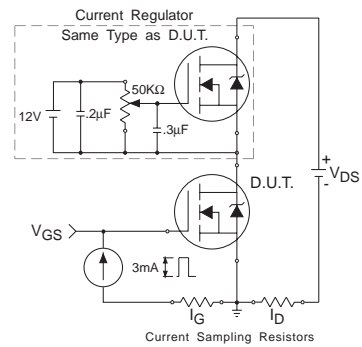

**Fig 13b.** Gate Charge Test Circuit

**Peak Diode Recovery dv/dt Test Circuit**



\*  $V_{GS} = 5V$  for Logic Level Devices

**Fig 14.** For N-Channel HEXFET® Power MOSFETs

# IRFB/IRFS/IRFSL59N10D



## TO-220AB Package Outline

Dimensions are shown in millimeters (inches)



### NOTES:

- 1 DIMENSIONING & TOLERANCING PER ANSI Y14.5M, 1982.
- 2 CONTROLLING DIMENSION : INCH

- 3 OUTLINE CONFORMS TO JEDEC OUTLINE TO-220AB.
- 4 HEATSINK & LEAD MEASUREMENTS DO NOT INCLUDE BURRS.

## TO-220AB Part Marking Information

EXAMPLE : THIS IS AN IRF1010  
WITH ASSEMBLY  
LOT CODE 9B1M

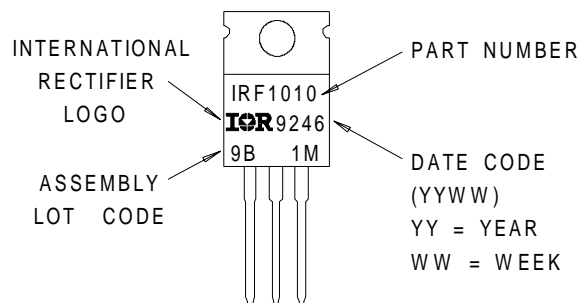



## D<sup>2</sup>Pak Package Outline

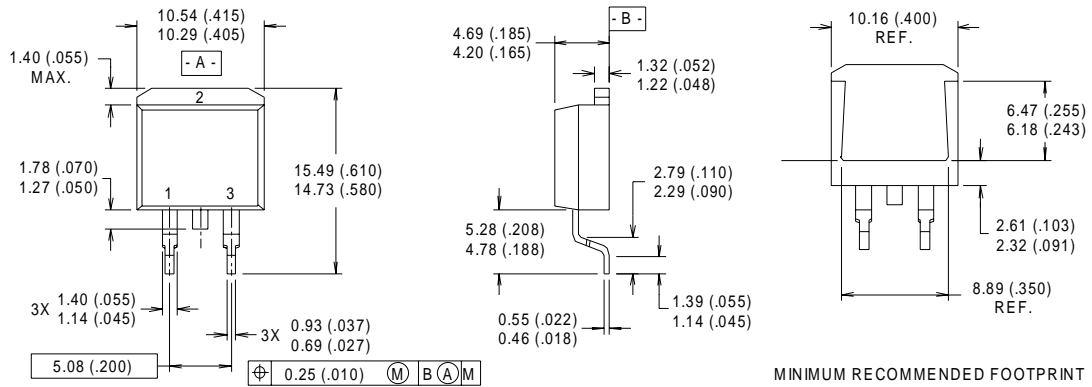

**NOTES:**

- 1 DIMENSIONS AFTER SOLDER DIP.
- 2 DIMENSIONING & TOLERANCING PER ANSI Y14.5M, 1982.
- 3 CONTROLLING DIMENSION : INCH.
- 4 HEATSINK & LEAD DIMENSIONS DO NOT INCLUDE BURRS.

**LEAD ASSIGNMENTS**

- 1 - GATE
- 2 - DRAIN
- 3 - SOURCE

## D<sup>2</sup>Pak Part Marking Information

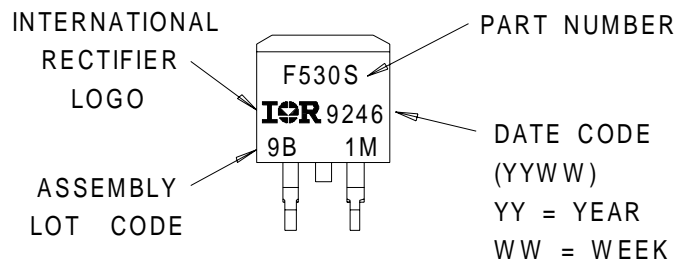

# IRFB/IRFS/IRFSL59N10D

International  
**IR** Rectifier

## TO-262 Package Outline

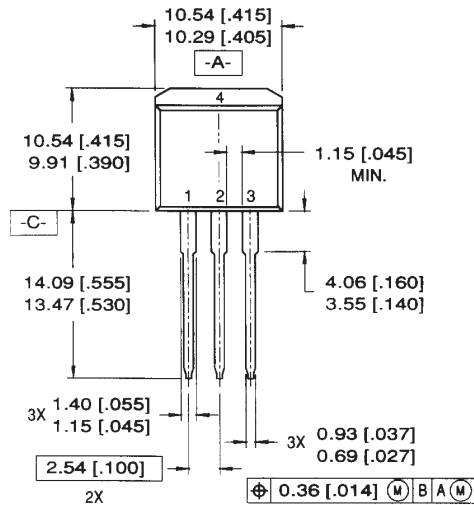

### LEAD ASSIGNMENTS

- |           |            |
|-----------|------------|
| 1 = GATE  | 3 = SOURCE |
| 2 = DRAIN | 4 = DRAIN  |

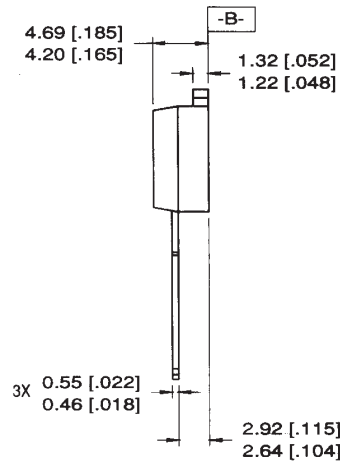

### NOTES:

1. DIMENSIONING & TOLERANCING PER ANSI Y14.5M-1982
2. CONTROLLING DIMENSION: INCH.
3. DIMENSIONS ARE SHOWN IN MILLIMETERS [INCHES].
4. HEATSINK & LEAD DIMENSIONS DO NOT INCLUDE BURRS.

## TO-262 Part Marking Information

EXAMPLE: THIS IS AN IRL3103L  
LOT CODE 1789  
ASSEMBLED ON WW 19, 1997  
IN THE ASSEMBLY LINE "C"

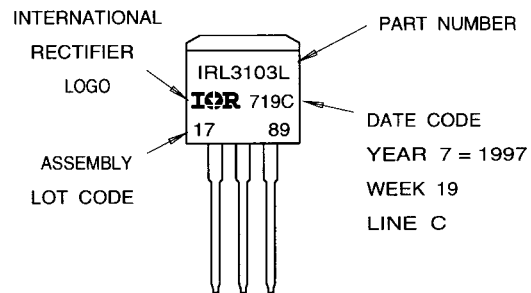

## D<sup>2</sup>Pak Tape & Reel Information

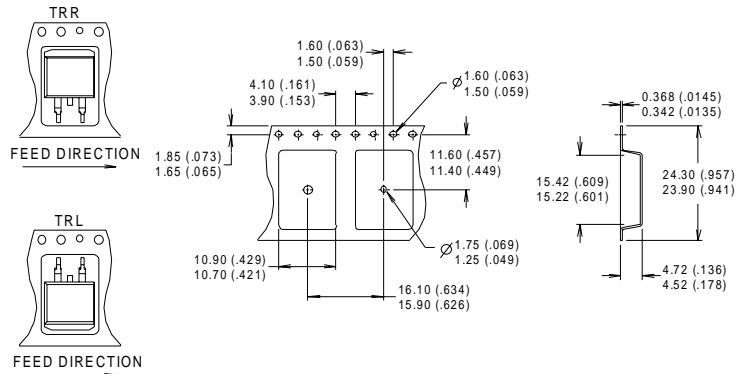

- NOTES :
1. CONFORMS TO EIA-418.
  2. CONTROLLING DIMENSION: MILLIMETER.
  3. DIMENSION MEASURED @ HUB.
  4. INCLUDES FLANGE DISTORTION @ OUTER EDGE.

### Notes:

- ① Repetitive rating; pulse width limited by max. junction temperature.
- ② Starting  $T_J = 25^\circ\text{C}$ ,  $L = 0.8\text{mH}$   
 $R_G = 25\Omega$ ,  $I_{AS} = 35.4\text{A}$ .
- ③  $I_{SD} \leq 35.4\text{A}$ ,  $di/dt \leq 350\text{A}/\mu\text{s}$ ,  $V_{DD} \leq V_{(BR)DSS}$ ,  
 $T_J \leq 175^\circ\text{C}$
- ④ Pulse width  $\leq 300\mu\text{s}$ ; duty cycle  $\leq 2\%$ .
- ⑤  $C_{OSS}$  eff. is a fixed capacitance that gives the same charging time as  $C_{OSS}$  while  $V_{DS}$  is rising from 0 to 80%  $V_{DSS}$
- ⑥ This is only applied to TO-220AB package
- ⑦ This is applied to D<sup>2</sup>Pak, when mounted on 1" square PCB ( FR-4 or G-10 Material ).  
 For recommended footprint and soldering techniques refer to application note #AN-994.

Note: For the most current drawings please refer to the IR website at:  
<http://www.irf.com/package/>

## X-ON Electronics

Largest Supplier of Electrical and Electronic Components

*Click to view similar products for [infineon](#) manufacturer:*

Other Similar products are found below :

[TLE6209R](#) [EVALM113023645ATOBO1](#) [EVALM11302TOBO1](#) [FD1000R33HE3-K](#) [FD300R06KE3](#) [FF1200R17KE3\\_B2](#)  
[FF300R06KE3HOSA1](#) [FF600R12ME4P](#) [FF600R17ME4\\_B11](#) [FP25R12KT4\\_B11](#) [FS600R07A2E3\\_B31](#) [FZ1600R17HP4\\_B2](#)  
[FZ1800R17KF4](#) [FZ2400R17HE4\\_B9](#) [FZ600R65KE3](#) [DD261N22K](#) [DF1000R17IE4](#) [AUIRL1404ZS](#) [BAS 40-04 E6327](#)  
[BAS4007WH6327XTSA1](#) [BAS 70-04 E6327](#) [BAS 70-06 E6327](#) [BAT15099E6327HTSA1](#) [BAT 165 E6327](#) [BAT 60A E6327](#) [BAT 60B](#)  
[E6327](#) [BC 817SU E6327](#) [BC 817U E6327](#) [BC 817UPN E6327](#) [BC 846PN H6327](#) [BC 846UPN E6327](#) [BC 847PN H6327](#) [BCM 856S H6327](#)  
[BCP5416H6327XTSA1](#) [BCP55H6327XTSA1](#) [BCP5616H6327XTSA1](#) [BCR 108 E6327](#) [BCR 10PN H6327](#) [BCR 133W H6327](#) [BCR 141](#)  
[E6327](#) [BCR 141S H6327](#) [BCR 141W H6327](#) [BCR 162 E6327](#) [BCR 183W H6327](#) [BCR 185S H6327](#) [BCR 192 E6327](#) [BCR 198 E6327](#) [BCR](#)  
[35PN H6327](#) [BCR 523U E6327](#) [BCR 533 E6327](#)