

IRG4BC30FDPbF

INSULATED GATE BIPOLAR TRANSISTOR WITH ULTRAFAST
 SOFT RECOVERY DIODE

Fast CoPack IGBT

Features

- Fast: Optimized for medium operating frequencies (1-5 kHz in hard switching, >20kHz in resonant mode).
- Generation 4 IGBT design provides tighter parameter distribution and higher efficiency than Generation 3
- IGBT co-packaged with HEXFRED™ ultrafast, ultra-soft-recovery anti-parallel diodes for use in bridge configurations
- Industry standard TO-220AB package
- Lead-Free

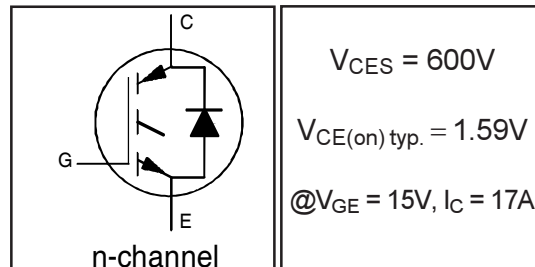

Benefits

- Generation -4 IGBT's offer highest efficiencies available
- IGBT's optimized for specific application conditions
- HEXFRED diodes optimized for performance with IGBT's. Minimized recovery characteristics require less/no snubbing
- Designed to be a "drop-in" replacement for equivalent industry-standard Generation 3 IR IGBT's

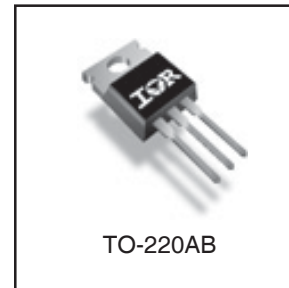

Absolute Maximum Ratings

	Parameter	Max.	Units
V_{CES}	Collector-to-Emitter Voltage	600	V
$I_C @ T_C = 25^\circ C$	Continuous Collector Current	31	A
$I_C @ T_C = 100^\circ C$	Continuous Collector Current	17	
I_{CM}	Pulsed Collector Current ①	124	
I_{LM}	Clamped Inductive Load Current ②	124	
$I_F @ T_C = 100^\circ C$	Diode Continuous Forward Current	12	
I_{FM}	Diode Maximum Forward Current	120	
V_{GE}	Gate-to-Emitter Voltage	± 20	V
$P_D @ T_C = 25^\circ C$	Maximum Power Dissipation	100	W
$P_D @ T_C = 100^\circ C$	Maximum Power Dissipation	42	
T_J	Operating Junction and Storage Temperature Range	-55 to +150	$^\circ C$
T_{STG}			
	Mounting Torque, 6-32 or M3 Screw.	10 lbf•in (1.1 N•m)	

Thermal Resistance

	Parameter	Min.	Typ.	Max.	Units
$R_{\theta JC}$	Junction-to-Case - IGBT	-----	-----	1.2	$^\circ C/W$
$R_{\theta JC}$	Junction-to-Case - Diode	-----	-----	2.5	
$R_{\theta CS}$	Case-to-Sink, flat, greased surface	-----	0.50	-----	
$R_{\theta JA}$	Junction-to-Ambient, typical socket mount	-----	-----	80	
Wt	Weight	-----	2 (0.07)	-----	g (oz)

IRG4BC30FDPbF

Electrical Characteristics @ T_J = 25°C (unless otherwise specified)

	Parameter	Min.	Typ.	Max.	Units	Conditions
V _{(BR)CES}	Collector-to-Emitter Breakdown Voltage ^③	600	----	----	V	V _{GE} = 0V, I _C = 250μA
ΔV _{(BR)CES} /ΔT _J	Temperature Coeff. of Breakdown Voltage	----	0.69	----	V/°C	V _{GE} = 0V, I _C = 1.0mA
V _{CE(on)}	Collector-to-Emitter Saturation Voltage	----	1.59	1.8	V	I _C = 17A, V _{GE} = 15V
		----	1.99	----		I _C = 31A
		----	1.70	----		I _C = 17A, T _J = 150°C
V _{GE(th)}	Gate Threshold Voltage	3.0	----	6.0		V _{CE} = V _{GE} , I _C = 250μA
ΔV _{GE(th)} /ΔT _J	Temperature Coeff. of Threshold Voltage	----	-11	----	mV/°C	V _{CE} = V _{GE} , I _C = 250μA
g _{fe}	Forward Transconductance ^④	6.1	10	----	S	V _{CE} = 100V, I _C = 17A
I _{CES}	Zero Gate Voltage Collector Current	----	----	250	μA	V _{GE} = 0V, V _{CE} = 600V
		----	----	2500		V _{GE} = 0V, V _{CE} = 600V, T _J = 150°C
V _{FM}	Diode Forward Voltage Drop	----	1.4	1.7	V	I _C = 12A
		----	1.3	1.6		I _C = 12A, T _J = 150°C
I _{GES}	Gate-to-Emitter Leakage Current	----	----	±100	nA	V _{GE} = ±20V

Switching Characteristics @ T_J = 25°C (unless otherwise specified)

	Parameter	Min.	Typ.	Max.	Units	Conditions
Q _g	Total Gate Charge (turn-on)	----	51	77	nC	I _C = 17A
Q _{ge}	Gate - Emitter Charge (turn-on)	----	7.9	12		V _{CC} = 400V
Q _{gc}	Gate - Collector Charge (turn-on)	----	19	28		V _{GE} = 15V
t _{d(on)}	Turn-On Delay Time	----	42	----	ns	T _J = 25°C
t _r	Rise Time	----	26	----		I _C = 17A, V _{CC} = 480V
t _{d(off)}	Turn-Off Delay Time	----	230	350		V _{GE} = 15V, R _G = 23Ω
t _f	Fall Time	----	160	230	mJ	Energy losses include "tail" and diode reverse recovery.
E _{on}	Turn-On Switching Loss	----	0.63	----		See Fig. 9, 10, 11, 18
E _{off}	Turn-Off Switching Loss	----	1.39	----		
E _{ts}	Total Switching Loss	----	2.02	3.9	mJ	T _J = 150°C, See Fig. 9, 10, 11, 18
t _{d(on)}	Turn-On Delay Time	----	42	----		I _C = 17A, V _{CC} = 480V
t _r	Rise Time	----	27	----		V _{GE} = 15V, R _G = 23Ω
t _{d(off)}	Turn-Off Delay Time	----	310	----	mJ	Energy losses include "tail" and diode reverse recovery.
t _f	Fall Time	----	310	----		
E _{ts}	Total Switching Loss	----	3.2	----		
L _E	Internal Emitter Inductance	----	7.5	----	nH	Measured 5mm from package
C _{ies}	Input Capacitance	----	1100	----	pF	V _{GE} = 0V
C _{oes}	Output Capacitance	----	74	----		V _{CC} = 30V
C _{res}	Reverse Transfer Capacitance	----	14	----		f = 1.0MHz
t _{rr}	Diode Reverse Recovery Time	----	42	60	ns	T _J = 25°C See Fig. 14
		----	80	120		T _J = 125°C
I _{rr}	Diode Peak Reverse Recovery Current	----	3.5	6.0	A	T _J = 25°C See Fig. 15
		----	5.6	10		T _J = 125°C
Q _{rr}	Diode Reverse Recovery Charge	----	80	180	nC	T _J = 25°C See Fig. 16
		----	220	600		T _J = 125°C
di _(rec) M/dt	Diode Peak Rate of Fall of Recovery During t _b	----	180	----	A/μs	T _J = 25°C See Fig. 17
		----	120	----		T _J = 125°C

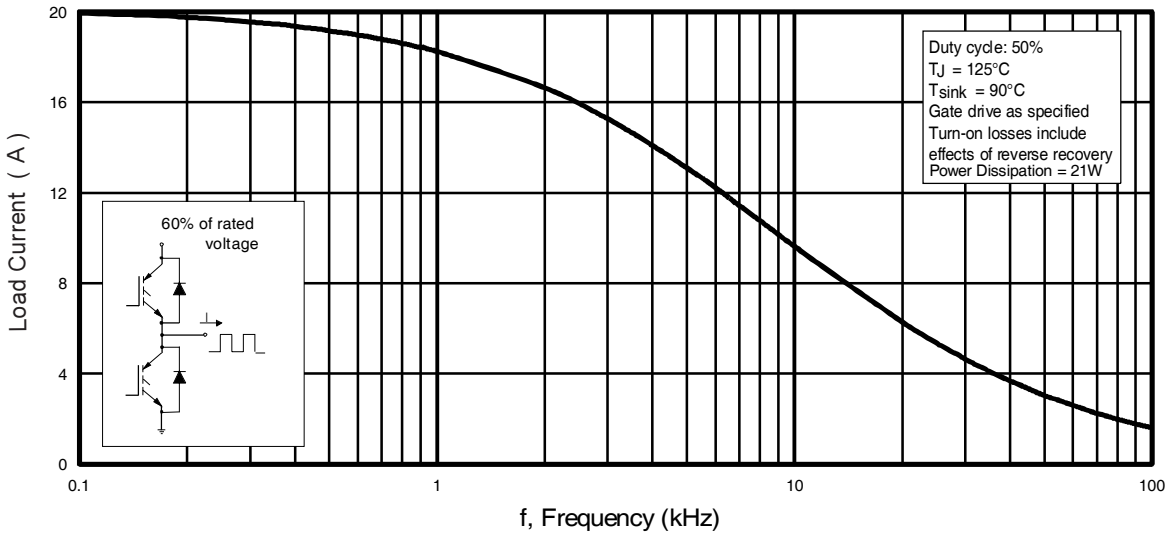

Fig. 1 - Typical Load Current vs. Frequency
 (Load Current = I_{RMS} of fundamental)

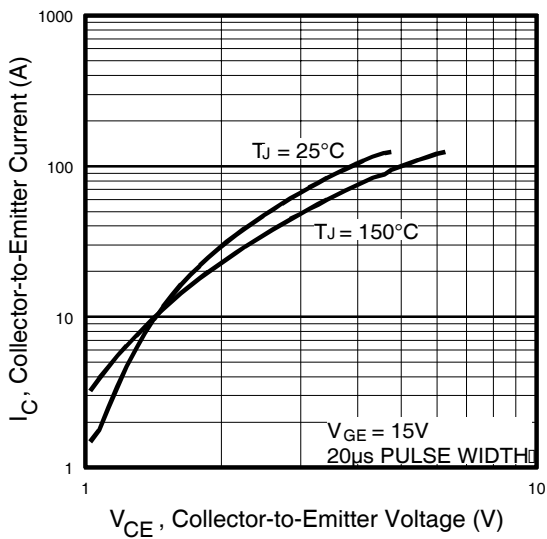

Fig. 2 - Typical Output Characteristics

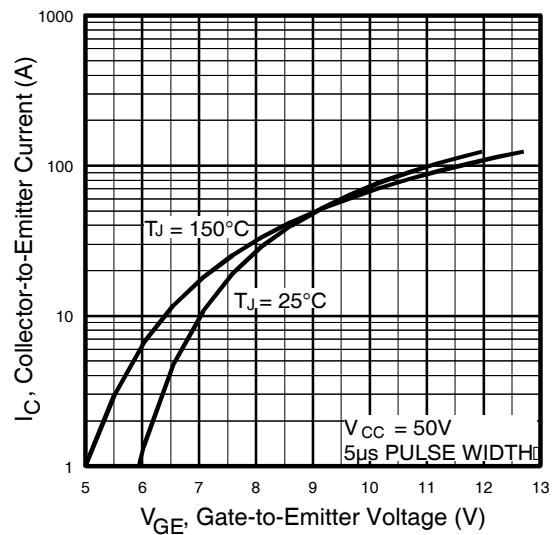

Fig. 3 - Typical Transfer Characteristics

IRG4BC30FDPbF

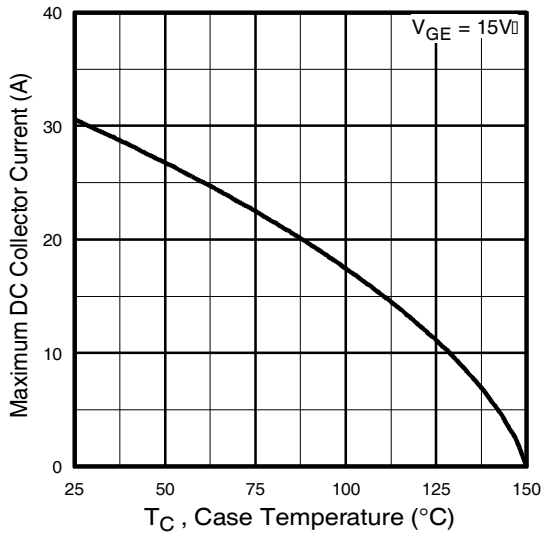

Fig. 4 - Maximum Collector Current vs. Case Temperature

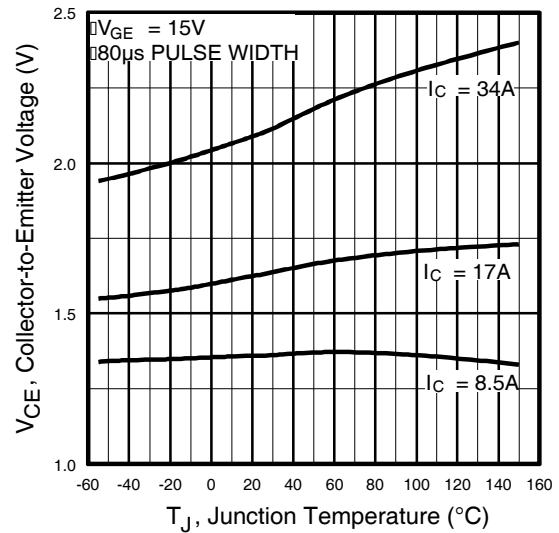

Fig. 5 - Typical Collector-to-Emitter Voltage vs. Junction Temperature

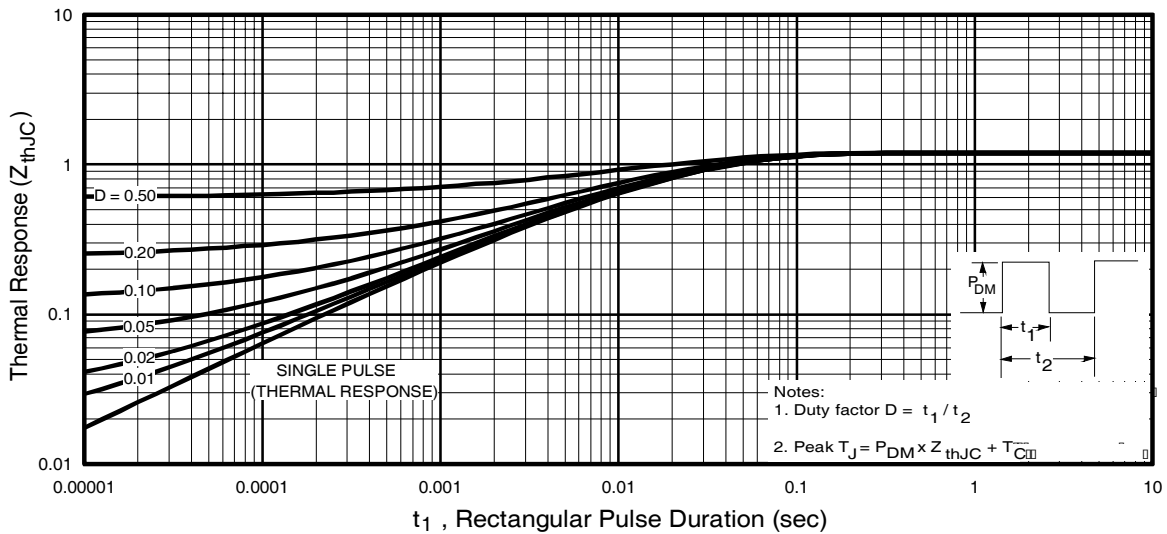

Fig. 6 - Maximum Effective Transient Thermal Impedance, Junction-to-Case

IRG4BC30FDPbF

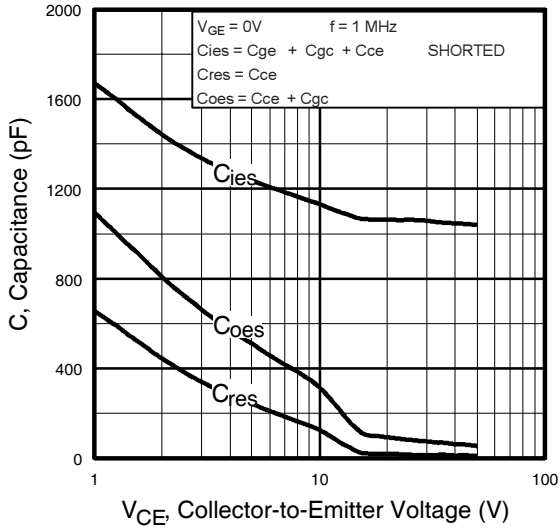

Fig. 7 - Typical Capacitance vs. Collector-to-Emitter Voltage

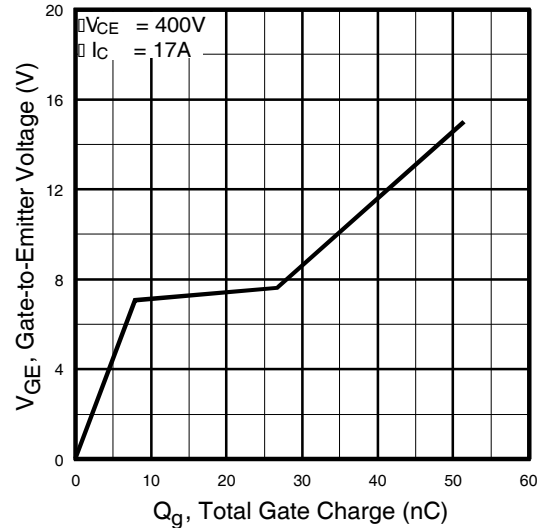

Fig. 8 - Typical Gate Charge vs. Gate-to-Emitter Voltage

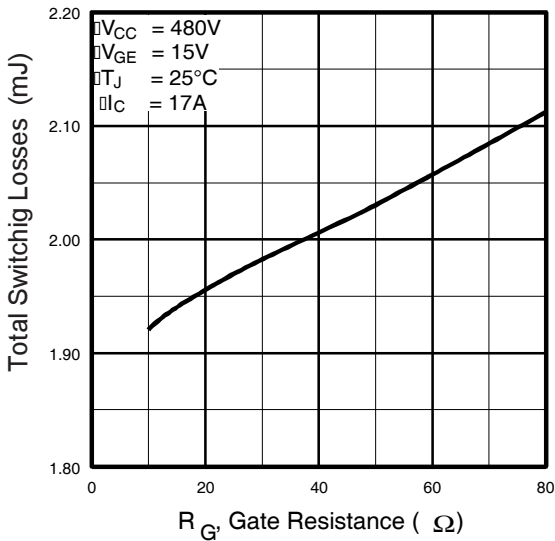

Fig. 9 - Typical Switching Losses vs. Gate Resistance

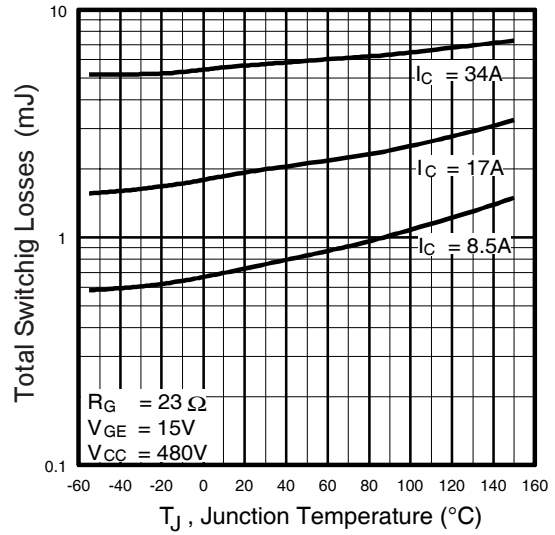

Fig. 10 - Typical Switching Losses vs. Junction Temperature

IRG4BC30FDPbF

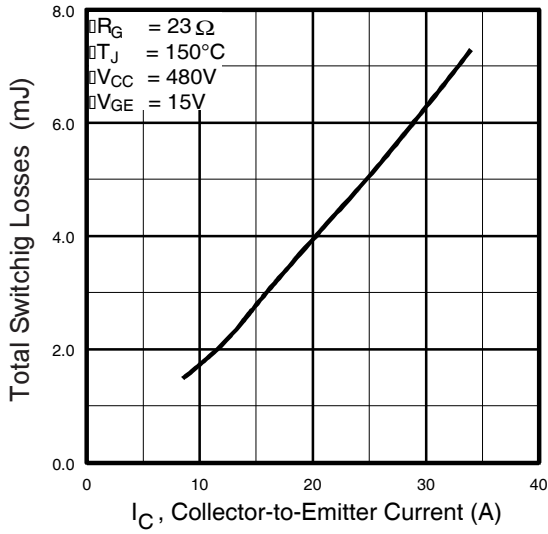

Fig. 11 - Typical Switching Losses vs. Collector-to-Emitter Current

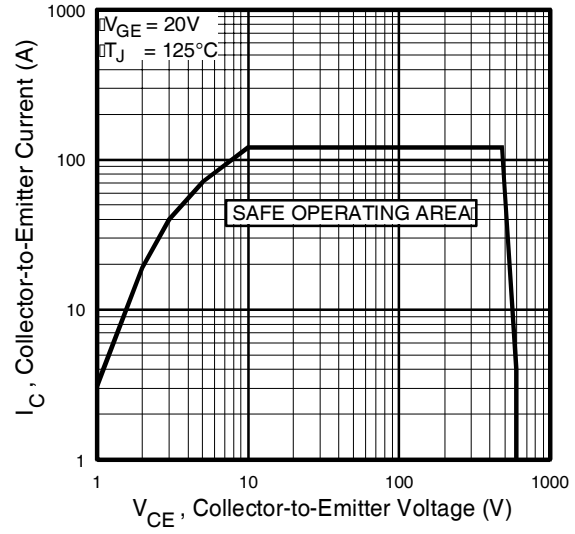

Fig. 12 - Turn-Off SOA

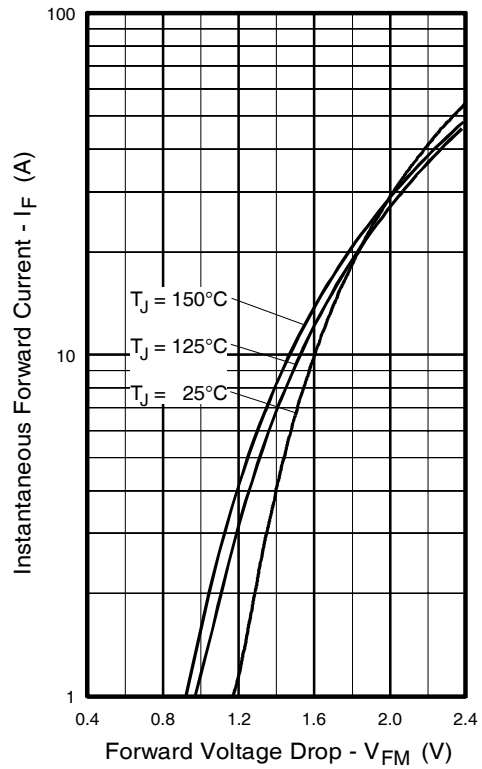

Fig. 13 - Maximum Forward Voltage Drop vs. Instantaneous Forward Current

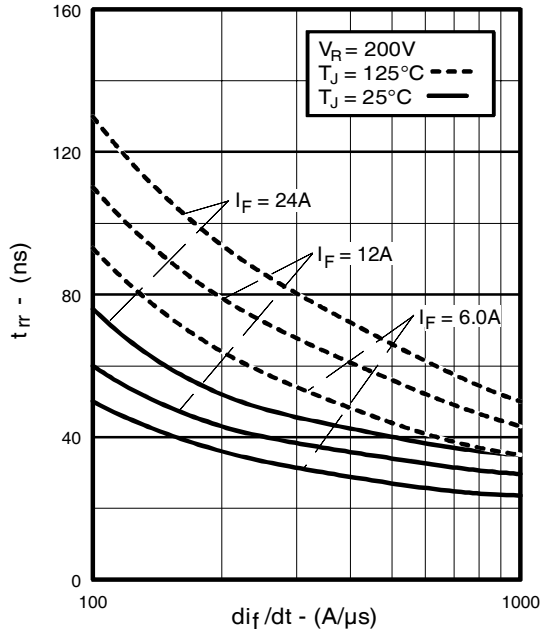

Fig. 14 - Typical Reverse Recovery vs. di_f/dt

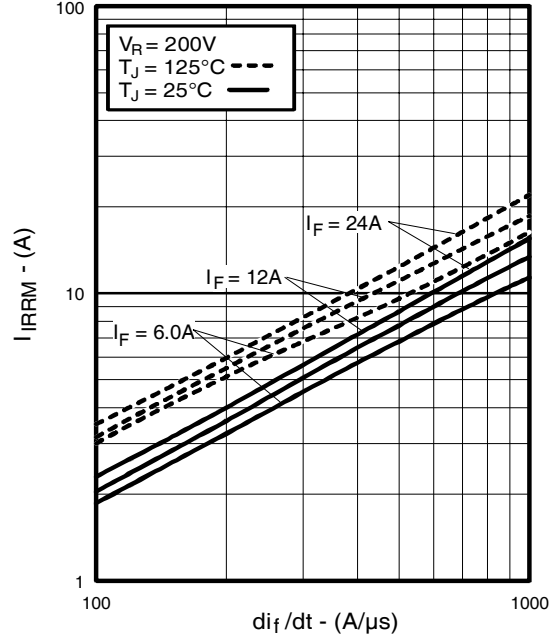

Fig. 15 - Typical Recovery Current vs. di_f/dt

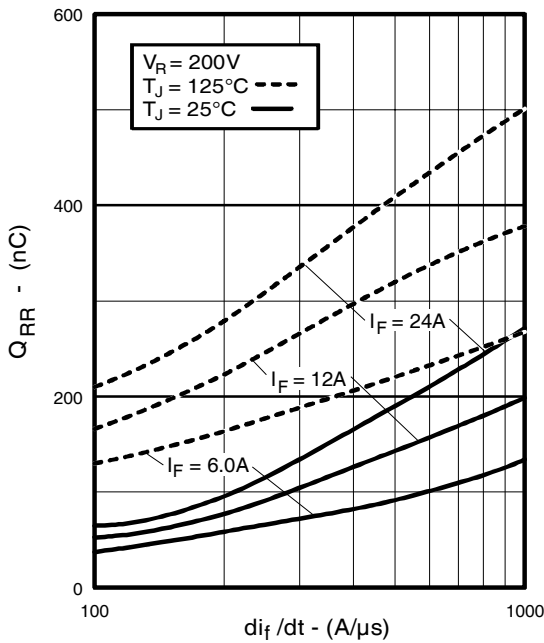

Fig. 16 - Typical Stored Charge vs. di_f/dt

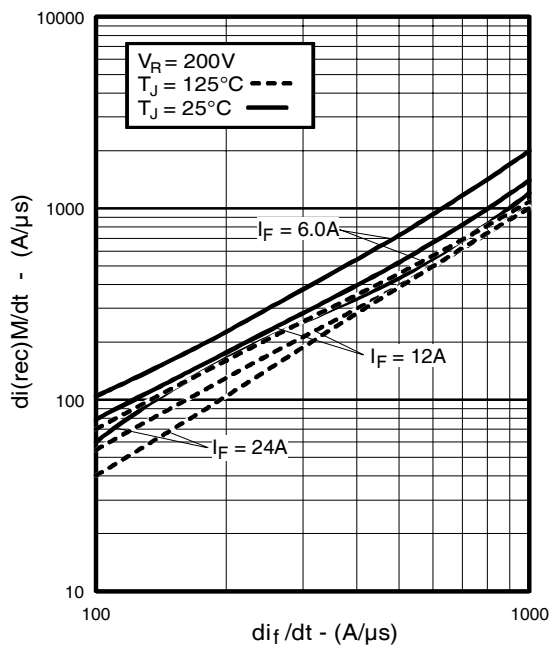

Fig. 17 - Typical $di_{(rec)M}/dt$ vs. di_f/dt

IRG4BC30FDPbF



Fig. 18a - Test Circuit for Measurement of I_{LM} , E_{on} , $E_{off}(\text{diode})$, t_{rr} , Q_{rr} , I_{rr} , $t_{d(on)}$, t_r , $t_{d(off)}$, t_f

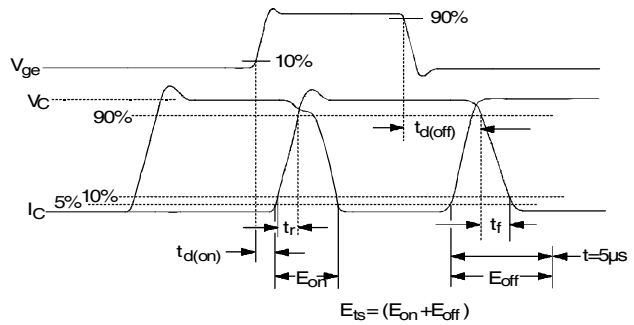

Fig. 18b - Test Waveforms for Circuit of Fig. 18a, Defining E_{off} , $t_{d(off)}$, t_f

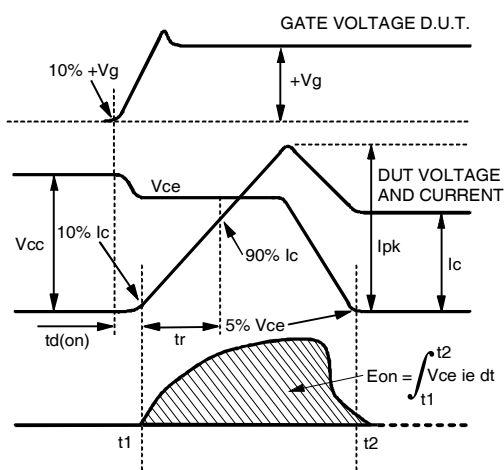

Fig. 18c - Test Waveforms for Circuit of Fig. 18a, Defining E_{on} , $t_{d(on)}$, t_r

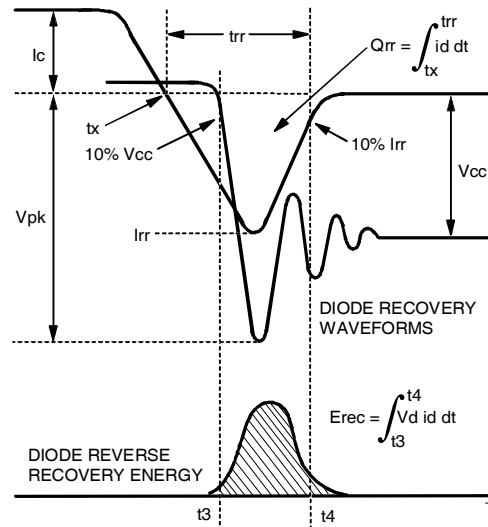

Fig. 18d - Test Waveforms for Circuit of Fig. 18a, Defining E_{rec} , t_{rr} , Q_{rr} , I_{rr}

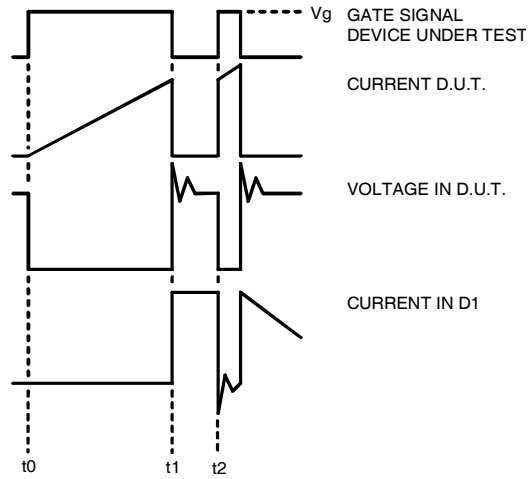

Figure 18e. Macro Waveforms for Figure 18a's Test Circuit

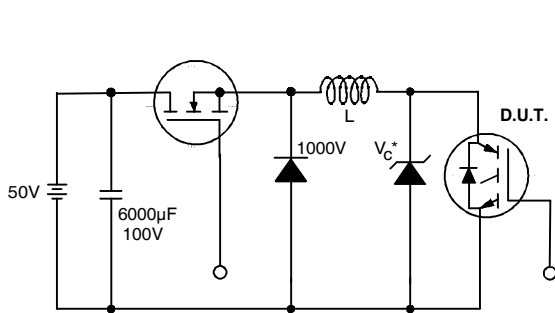
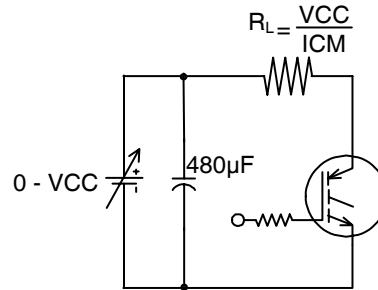

Figure 19. Clamped Inductive Load Test Circuit



Pulsed Collector Current Test Circuit

Figure 20. Pulsed Collector Current Test Circuit

IRG4BC30FDPbF

International
IR Rectifier

TO-220AB Package Outline (Dimensions are shown in millimeters (inches))

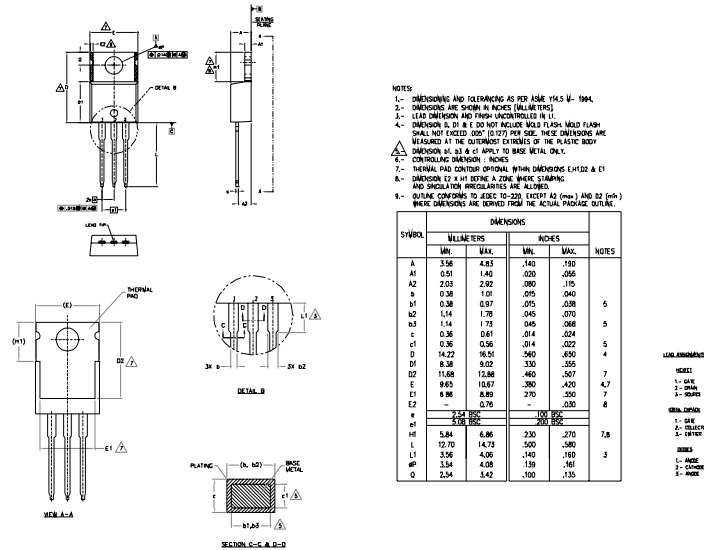

TO-220AB Part Marking Information

EXAMPLE: THIS IS AN IRF1010
LOT CODE 1789
ASSEMBLED ON WW 19, 1 1997
IN THE ASSEMBLY LINE 'C'
Note: "P" in assembly line
position indicates "Lead-Free"

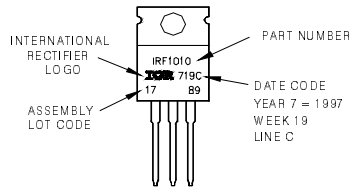

Note: For the most current drawing please refer to IR website at <http://www.irf.com/package/>

Notes:

- ① Repetitive rating: $V_{GE}=20V$; pulse width limited by maximum junction temperature (figure 20)
- ② $V_{CC}=80\%(V_{CES})$, $V_{GE}=20V$, $L=10\mu H$, $R_G = 23\Omega$ (figure 19)
- ③ Pulse width $\leq 80\mu s$; duty factor $\leq 0.1\%$.
- ④ Pulse width $5.0\mu s$, single shot.

Data and specifications subject to change without notice.

International
IR Rectifier

IR WORLD HEADQUARTERS: 233 Kansas St., El Segundo, California 90245, USA Tel: (310) 252-7105
TAC Fax: (310) 252-7903

Visit us at www.irf.com for sales contact information. 01/2010

www.irf.com

X-ON Electronics

Largest Supplier of Electrical and Electronic Components

Click to view similar products for [IGBT Transistors](#) category:

Click to view products by [Infineon](#) manufacturer:

Other Similar products are found below :

[748152A](#) [APT20GT60BRDQ1G](#) [APT50GT60BRG](#) [NGTB10N60FG](#) [STGFW20V60DF](#) [APT30GP60BG](#) [APT45GR65B2DU30](#)
[GT50JR22\(STA1ES\)](#) [TIG058E8-TL-H](#) [IGW40N120H3FKSA1](#) [VS-CPV364M4KPBF](#) [NGTB25N120FL2WAG](#) [NGTG40N120FL2WG](#)
[RJH60F3DPQ-A0#T0](#) [APT40GR120B2SCD10](#) [APT15GT120BRG](#) [APT20GT60BRG](#) [NGTB75N65FL2WAG](#) [NGTG15N120FL2WG](#)
[IXA30RG1200DHGLB](#) [IXA40RG1200DHGLB](#) [APT70GR65B2DU40](#) [NTE3320](#) [QP12W05S-37A](#) [IHF40N65R5SXXSA1](#) [APT70GR120J](#)
[APT35GP120JDQ2](#) [XD15H120CX1](#) [XD25H120CX0](#) [XP15PJS120CL1B1](#) [IGW30N60H3FKSA1](#) [STGWA8M120DF3](#) [IGW08T120FKSA1](#)
[IGW75N60H3FKSA1](#) [FGH60N60SMD_F085](#) [FGH75T65UPD](#) [STGWA15H120F2](#) [IKA10N60TXKSA1](#) [IHW20N120R5XKSA1](#)
[RJH60D2DPP-M0#T2](#) [IKP20N60TXKSA1](#) [IHW20N65R5XKSA1](#) [APT70GR120JD60](#) [AOD5B60D](#) [APT70GR120L](#) [STGWT60H65FB](#)
[STGWT60H65DFB](#) [STGWT40V60DF](#) [STGWT20V60DF](#) [STGB10NB37LZT4](#)