

IRG4BC30UDPbF

INSULATED GATE BIPOLAR TRANSISTOR WITH
 ULTRAFast SOFT RECOVERY DIODE

UltraFast CoPack IGBT

Features

- UltraFast: Optimized for high operating frequencies 8-40 kHz in hard switching, >200 kHz in resonant mode
- Generation 4 IGBT design provides tighter parameter distribution and higher efficiency than Generation 3
- IGBT co-packaged with HEXFRED™ ultrafast, ultra-soft-recovery anti-parallel diodes for use in bridge configurations
- Industry standard TO-220AB package
- Lead-Free

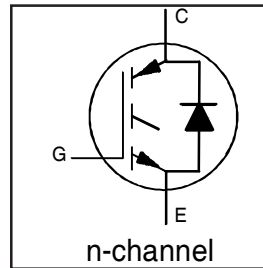

$V_{CES} = 600V$
$V_{CE(on) typ.} = 1.95V$
@ $V_{GE} = 15V, I_C = 12A$

Benefits

- Generation -4 IGBT's offer highest efficiencies available
- IGBTs optimized for specific application conditions
- HEXFRED diodes optimized for performance with IGBTs . Minimized recovery characteristics require less/no snubbing
- Designed to be a "drop-in" replacement for equivalent industry-standard Generation 3 IR IGBTs

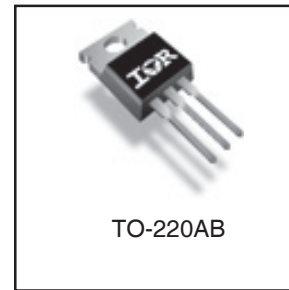

Absolute Maximum Ratings

	Parameter	Max.	Units
V_{CES}	Collector-to-Emitter Voltage	600	V
$I_C @ T_C = 25^\circ C$	Continuous Collector Current	23	A
$I_C @ T_C = 100^\circ C$	Continuous Collector Current	12	
I_{CM}	Pulsed Collector Current ①	92	
I_{LM}	Clamped Inductive Load Current ②	92	
$I_F @ T_C = 100^\circ C$	Diode Continuous Forward Current	12	
I_{FM}	Diode Maximum Forward Current	92	
V_{GE}	Gate-to-Emitter Voltage	± 20	V
$P_D @ T_C = 25^\circ C$	Maximum Power Dissipation	100	W
$P_D @ T_C = 100^\circ C$	Maximum Power Dissipation	42	
T_J	Operating Junction and Storage Temperature Range	-55 to +150	°C
T_{STG}			
	Mounting Torque, 6-32 or M3 Screw.	10 lbf•in (1.1 N•m)	

Thermal Resistance

	Parameter	Min.	Typ.	Max.	Units
$R_{\theta JC}$	Junction-to-Case - IGBT	-----	-----	1.2	°C/W
$R_{\theta JC}$	Junction-to-Case - Diode	-----	-----	2.5	
$R_{\theta CS}$	Case-to-Sink, flat, greased surface	-----	0.50	-----	
$R_{\theta JA}$	Junction-to-Ambient, typical socket mount	-----	-----	80	
Wt	Weight	-----	2 (0.07)	-----	

Electrical Characteristics @ T_J = 25°C (unless otherwise specified)

	Parameter	Min.	Typ.	Max.	Units	Conditions
V _{(BR)CES}	Collector-to-Emitter Breakdown Voltage ^③	600	----	----	V	V _{GE} = 0V, I _C = 250μA
ΔV _{(BR)CES} /ΔT _J	Temperature Coeff. of Breakdown Voltage	----	0.63	----	V/°C	V _{GE} = 0V, I _C = 1.0mA
V _{CE(on)}	Collector-to-Emitter Saturation Voltage	----	1.95	2.1	V	I _C = 12A
		----	2.52	----		I _C = 23A
		----	2.09	----		I _C = 12A, T _J = 150°C
V _{GE(th)}	Gate Threshold Voltage	3.0	----	6.0		V _{CE} = V _{GE} , I _C = 250μA
ΔV _{GE(th)} /ΔT _J	Temperature Coeff. of Threshold Voltage	----	-11	----	mV/°C	V _{CE} = V _{GE} , I _C = 250μA
g _{fe}	Forward Transconductance ^④	3.1	8.6	----	S	V _{CE} = 100V, I _C = 12A
I _{CES}	Zero Gate Voltage Collector Current	----	----	250	μA	V _{GE} = 0V, V _{CE} = 600V
		----	----	2500		V _{GE} = 0V, V _{CE} = 600V, T _J = 150°C
V _{FM}	Diode Forward Voltage Drop	----	1.4	1.7	V	I _C = 12A
		----	1.3	1.6		I _C = 12A, T _J = 150°C
I _{GES}	Gate-to-Emitter Leakage Current	----	----	±100	nA	V _{GE} = ±20V

Switching Characteristics @ T_J = 25°C (unless otherwise specified)

	Parameter	Min.	Typ.	Max.	Units	Conditions	
Q _g	Total Gate Charge (turn-on)	----	50	75		I _C = 12A	
Q _{ge}	Gate - Emitter Charge (turn-on)	----	8.1	12	nC	V _{CC} = 400V	
Q _{gc}	Gate - Collector Charge (turn-on)	----	18	27		V _{GE} = 15V	
t _{d(on)}	Turn-On Delay Time	----	40	----		T _J = 25°C	
t _r	Rise Time	----	21	----	ns	I _C = 12A, V _{CC} = 480V	
t _{d(off)}	Turn-Off Delay Time	----	91	140		V _{GE} = 15V, R _G = 23Ω	
t _f	Fall Time	----	80	130		Energy losses include "tail" and diode reverse recovery.	
E _{on}	Turn-On Switching Loss	----	0.38	----	mJ	See Fig. 9, 10, 11, 18	
E _{off}	Turn-Off Switching Loss	----	0.16	----			
E _{ts}	Total Switching Loss	----	0.54	0.9			
t _{d(on)}	Turn-On Delay Time	----	40	----	ns	T _J = 150°C, See Fig. 9, 10, 11, 18	
t _r	Rise Time	----	22	----		I _C = 12A, V _{CC} = 480V	
t _{d(off)}	Turn-Off Delay Time	----	120	----		V _{GE} = 15V, R _G = 23Ω	
t _f	Fall Time	----	180	----	mJ	Energy losses include "tail" and diode reverse recovery.	
E _{ts}	Total Switching Loss	----	0.89	----			
L _E	Internal Emitter Inductance	----	7.5	----		nH	Measured 5mm from package
C _{ies}	Input Capacitance	----	1100	----	pF	V _{GE} = 0V	
C _{oes}	Output Capacitance	----	73	----		V _{CC} = 30V	
C _{res}	Reverse Transfer Capacitance	----	14	----		f = 1.0MHz	
t _{rr}	Diode Reverse Recovery Time	----	42	60	ns	T _J = 25°C See Fig.	
I _{rr}	Diode Peak Reverse Recovery Current	----	80	120		T _J = 125°C 14	I _F = 12A
		----	3.5	6.0		T _J = 25°C See Fig.	
Q _{rr}	Diode Reverse Recovery Charge	----	5.6	10	T _J = 125°C 15	V _R = 200V	
		----	80	180	T _J = 25°C See Fig.		
di _(rec) M/dt	Diode Peak Rate of Fall of Recovery During t _b	----	220	600	T _J = 125°C 16		di/dt 200A/μs
		----	180	----	T _J = 25°C See Fig.		
		----	120	----	T _J = 125°C 17		

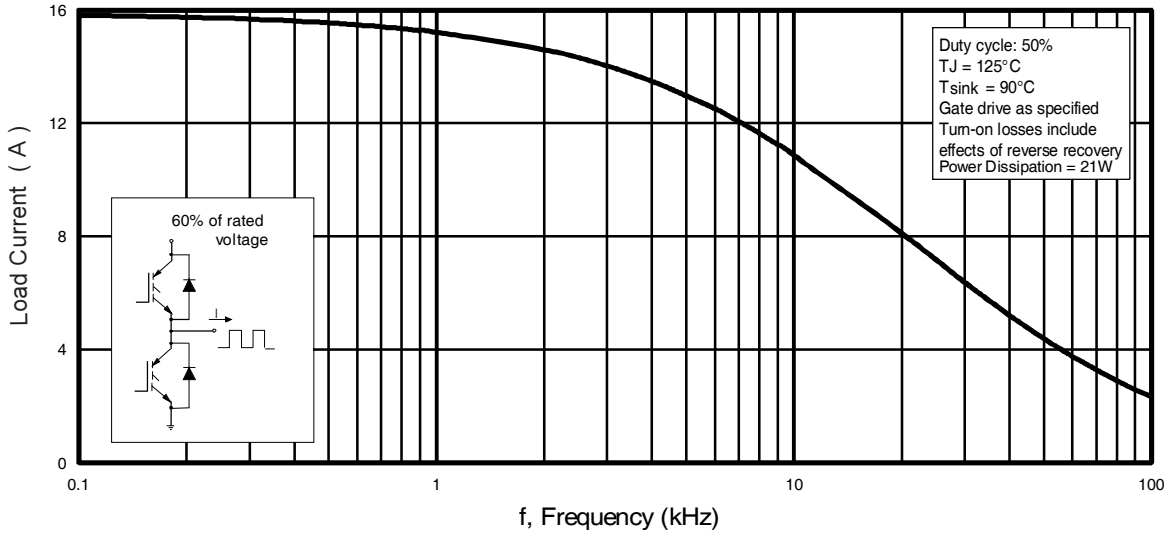

Fig. 1 - Typical Load Current vs. Frequency
(Load Current = I_{RMS} of fundamental)

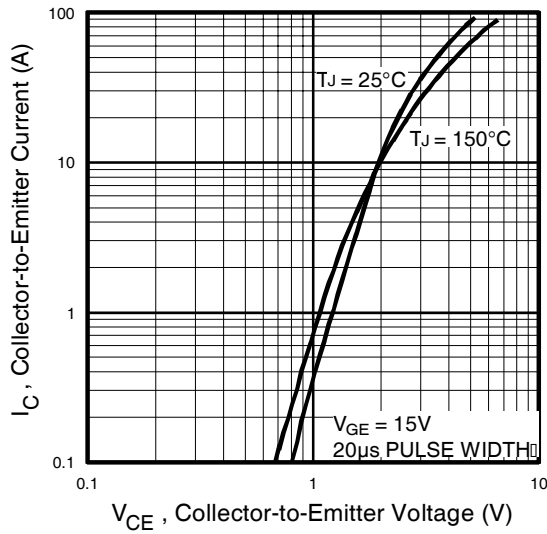

Fig. 2 - Typical Output Characteristics

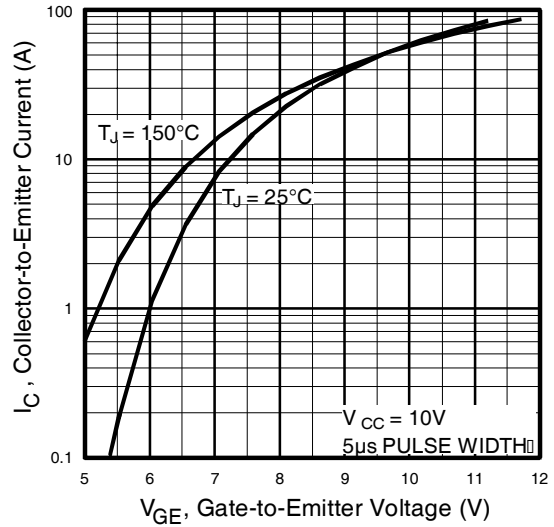

Fig. 3 - Typical Transfer Characteristics

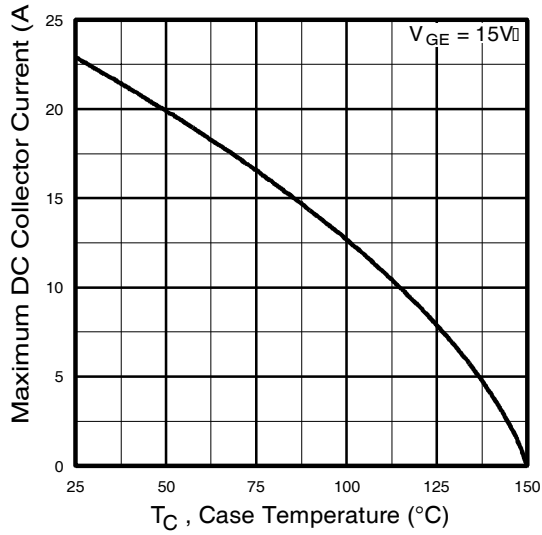

Fig. 4 - Maximum Collector Current vs. Case Temperature

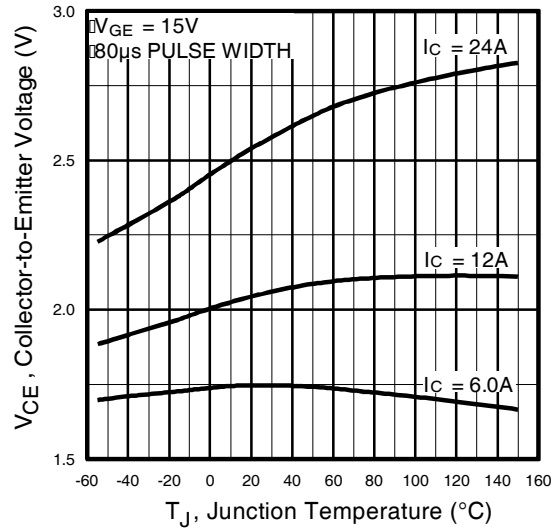

Fig. 5 - Typical Collector-to-Emitter Voltage vs. Junction Temperature

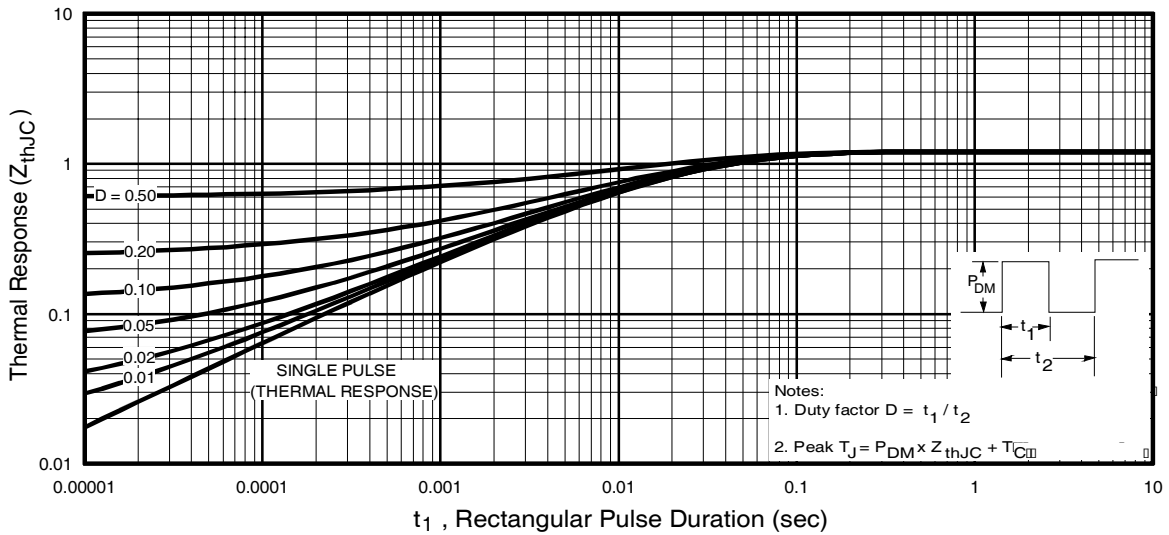

Fig. 6 - Maximum IGBT Effective Transient Thermal Impedance, Junction-to-Case

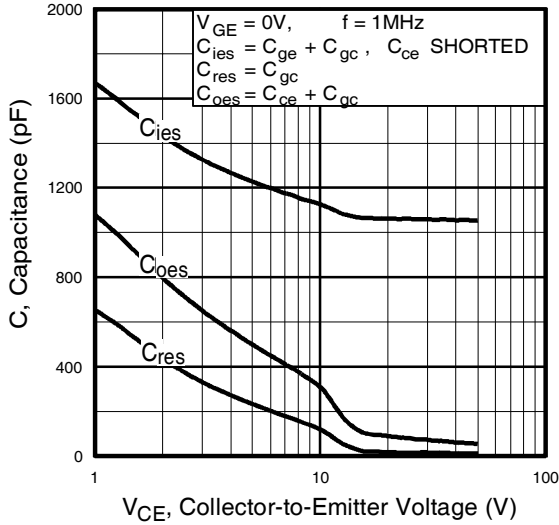

Fig. 7 - Typical Capacitance vs. Collector-to-Emitter Voltage

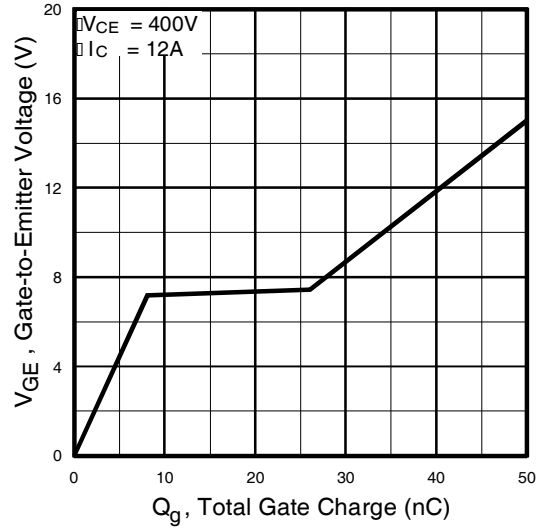

Fig. 8 - Typical Gate Charge vs. Gate-to-Emitter Voltage

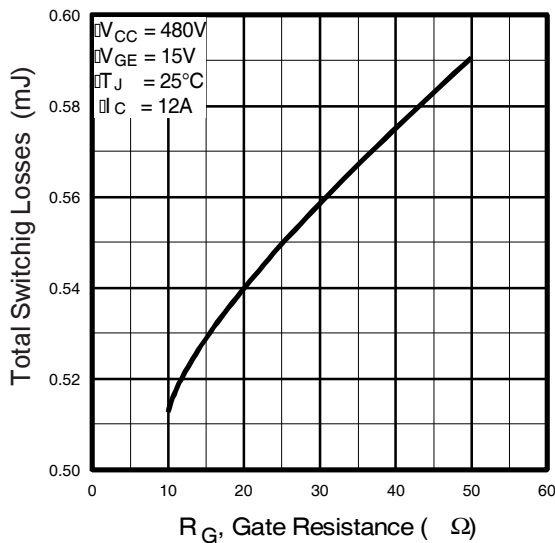

Fig. 9 - Typical Switching Losses vs. Gate Resistance

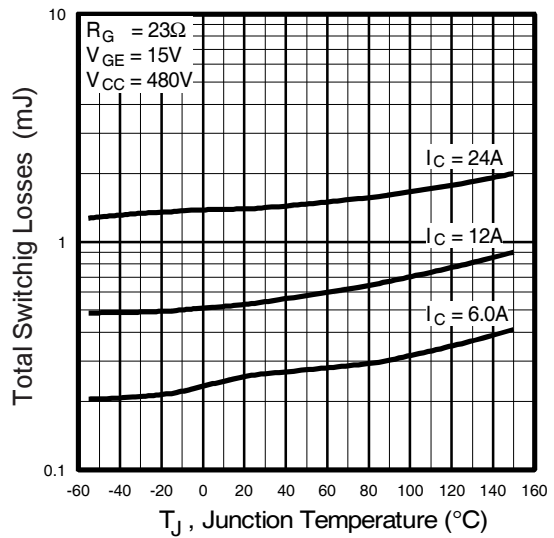

Fig. 10 - Typical Switching Losses vs. Junction Temperature

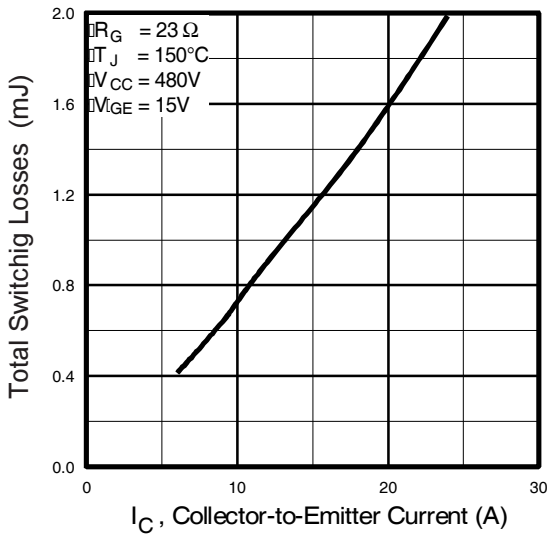

Fig. 11 - Typical Switching Losses vs. Collector-to-Emitter Current

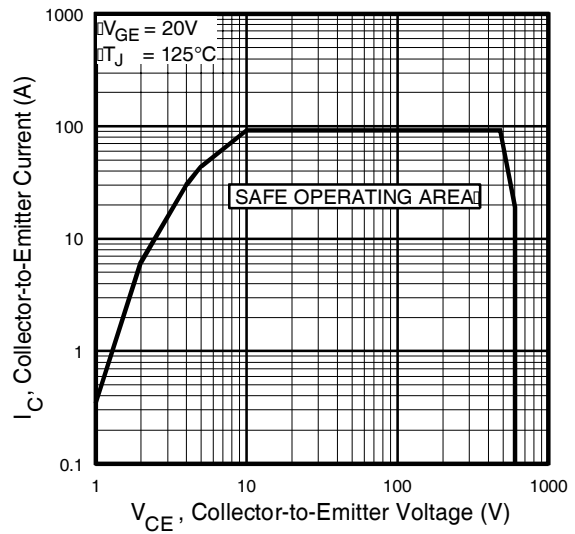

Fig. 12 - Turn-Off SOA

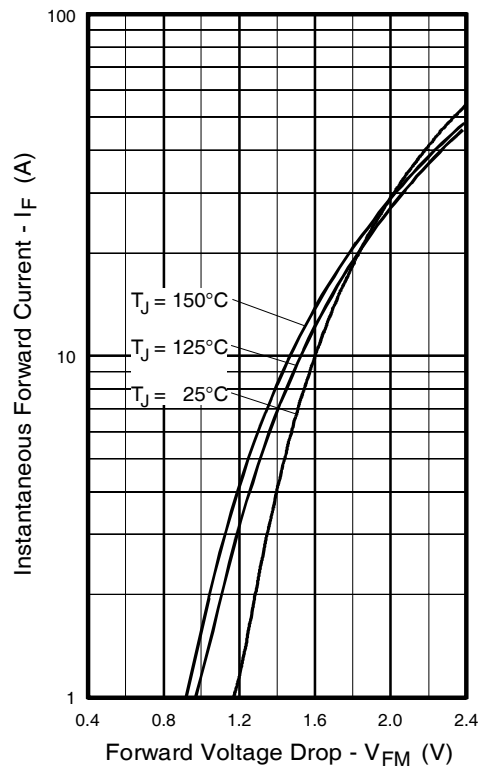

Fig. 13 - Maximum Forward Voltage Drop vs. Instantaneous Forward Current

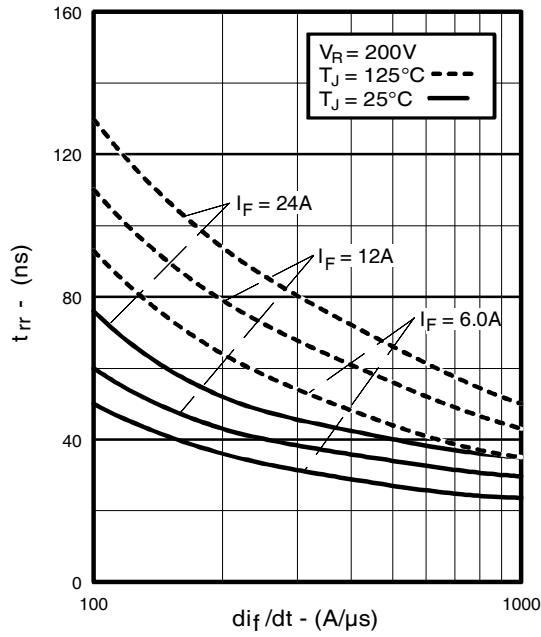

Fig. 14 - Typical Reverse Recovery vs. di_f/dt

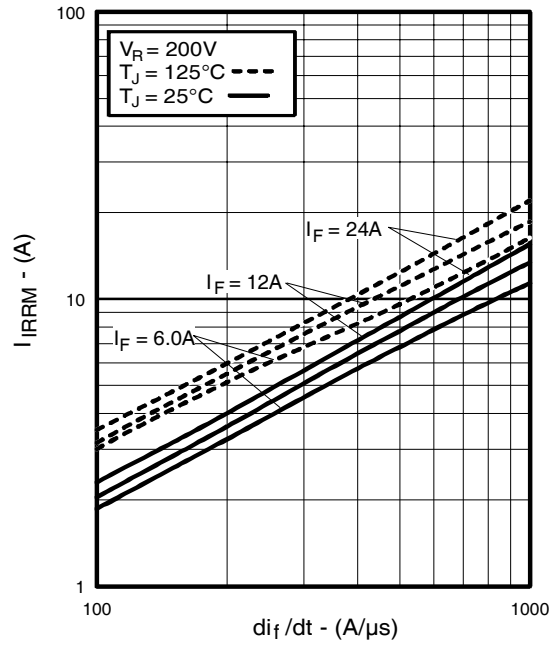

Fig. 15 - Typical Recovery Current vs. di_f/dt

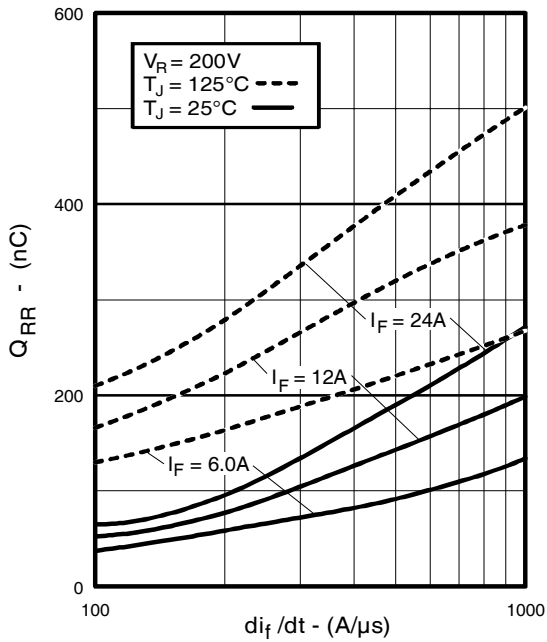

Fig. 16 - Typical Stored Charge vs. di_f/dt

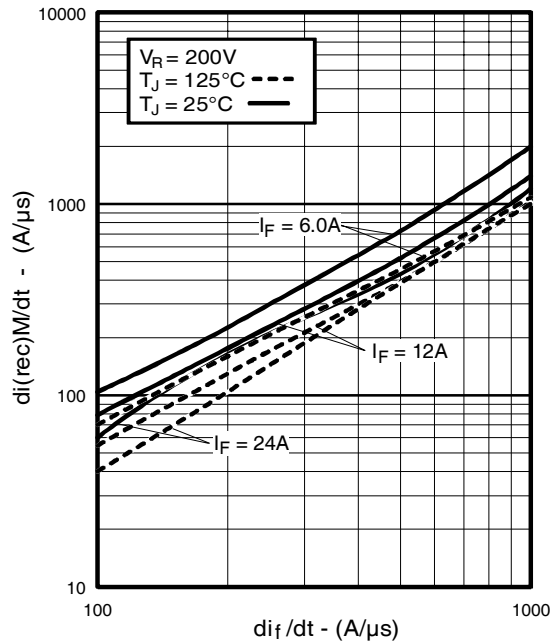

Fig. 17 - Typical $di_{(rec)M}/dt$ vs. di_f/dt

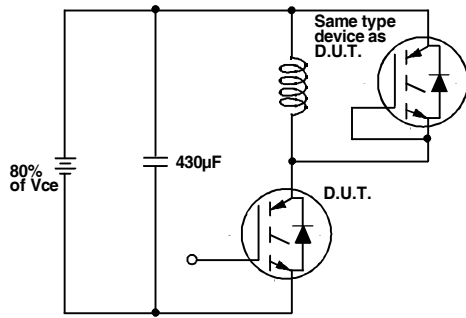

Fig. 18a - Test Circuit for Measurement of I_{LM} , E_{on} , $E_{off}(\text{diode})$, t_{rr} , Q_{rr} , I_{rr} , $t_{d(on)}$, t_r , $t_{d(off)}$, t_f

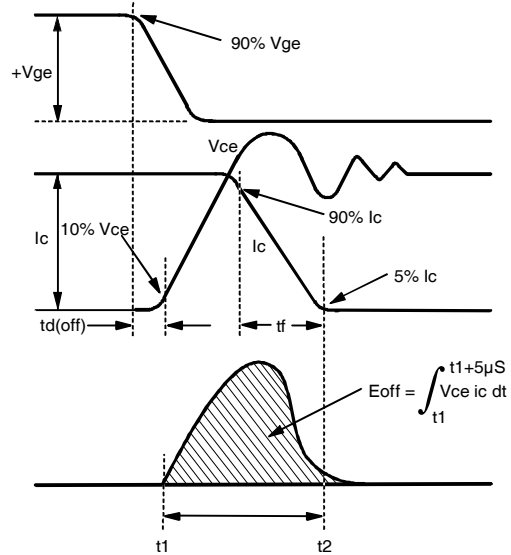

Fig. 18b - Test Waveforms for Circuit of Fig. 18a, Defining E_{off} , $t_{d(off)}$, t_f

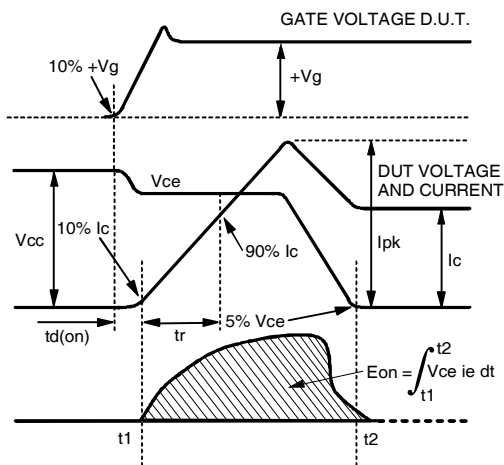

Fig. 18c - Test Waveforms for Circuit of Fig. 18a, Defining E_{on} , $t_{d(on)}$, t_r

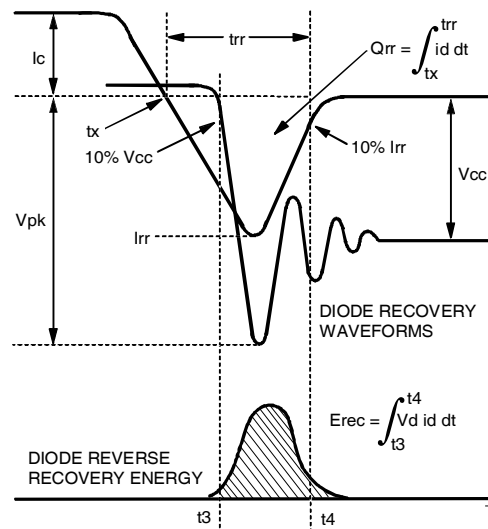

Fig. 18d - Test Waveforms for Circuit of Fig. 18a, Defining E_{rec} , t_{rr} , Q_{rr} , I_{rr}

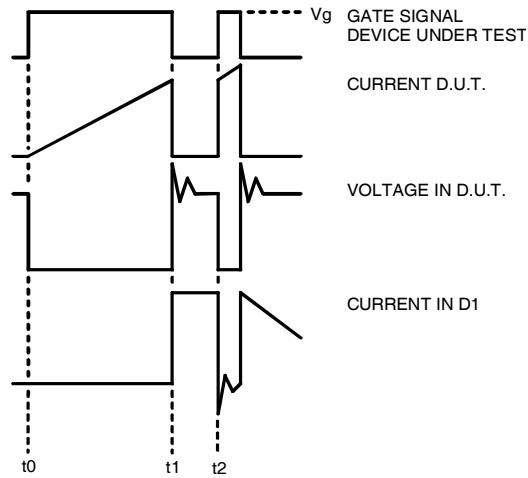

Figure 18e. Macro Waveforms for Figure 18a's Test Circuit

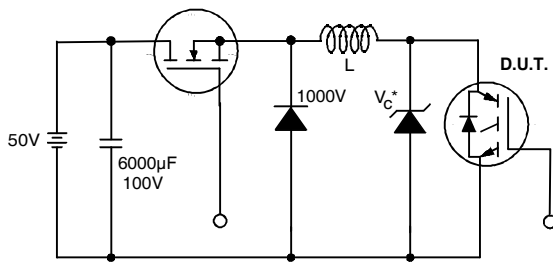
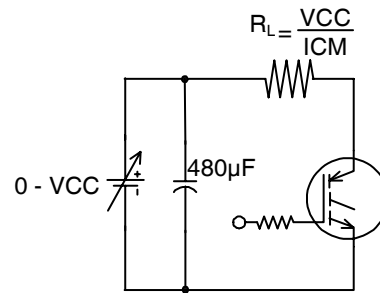

Figure 19. Clamped Inductive Load Test Circuit



Pulsed Collector Current Test Circuit
 Figure 20. Pulsed Collector Current Test Circuit

IRG4BC30UDPbF

International
IR Rectifier

Notes:

- ① Repetitive rating: $V_{GE}=20V$; pulse width limited by maximum junction temperature (figure 20)
- ② $V_{CC}=80\%(V_{CES})$, $V_{GE}=20V$, $L=10\mu H$, $R_G = 23\Omega$ (figure 19)
- ③ Pulse width $\leq 80\mu s$; duty factor $\leq 0.1\%$.
- ④ Pulse width $5.0\mu s$, single shot.

TO-220AB Package Outline (Dimensions are shown in millimeters (inches))

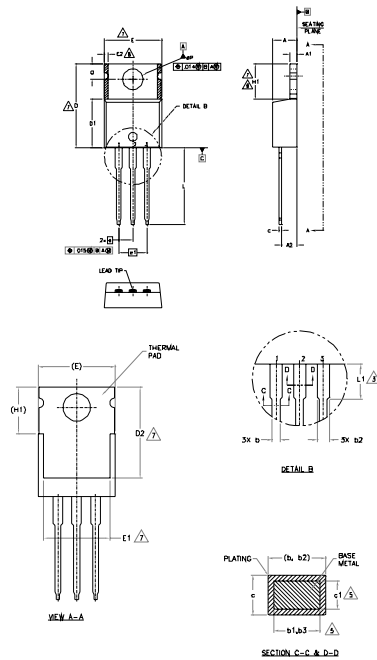

- NOTES:
- 1- DIMENSIONING AND TOLERANCING AS PER ASME Y14.5 M-1994.
 - 2- DIMENSIONS ARE SHOWN IN INCHES (MILLIMETERS).
 - 3- LEAD DIMENSION AND FINISH UNCONTROLLED IN 1:1.
 - 4- DIMENSION D, DI & E DO NOT INCLUDE MOLD FLASH. MOLD FLASH SHALL NOT EXCEED .005" (0.127) PER SIDE. THESE DIMENSIONS ARE MEASURED AT THE OUTERMOST EXTREMES OF THE PLASTIC BODY.
 - 5- DIMENSION b1, b3 & c1 APPLY TO BASE METAL ONLY.
 - 6- CONTROLLING DIMENSION - INCHES.
 - 7- THERMAL PAD CONTOURS OPTIONAL WITHIN DIMENSIONS E1, D2 & E1.
 - 8- DIMENSION E2 x H1 DEFINE A ZONE WHERE STAMPING AND SINGULATION IRREGULARITIES ARE ALLOWED.
 - 9- OUTLINE CONFORMS TO JEDEC TO-220, EXCEPT A2 (max.) AND D2 (min.) WHERE DIMENSIONS ARE DERIVED FROM THE ACTUAL PACKAGE OUTLINE.

SYMBOL	DIMENSIONS				NOTES
	MILLIMETERS		INCHES		
	MIN.	MAX.	MIN.	MAX.	
A	3.56	4.83	.140	.190	
A1	0.51	1.40	.020	.055	
A2	2.03	2.92	.080	.115	
b	0.38	1.01	.015	.040	5
b1	0.38	0.91	.015	.036	
b2	1.14	1.78	.045	.070	
b3	1.14	1.73	.045	.068	5
c	0.36	0.61	.014	.024	
c1	0.26	0.56	.014	.022	5
D	14.22	16.61	.560	.650	4
D1	8.38	9.02	.330	.355	7
D2	11.68	12.88	.460	.507	7
E	9.65	10.67	.380	.420	4, 7
E1	6.86	8.89	.270	.350	7
E2	-	0.76	-	0.30	8
e	2.54 BSC	-	.100 BSC	-	
e1	2.54 BSC	-	.100 BSC	-	
H1	5.84	6.86	.230	.270	7, 8
L	12.70	14.73	.500	.580	
L1	3.56	4.06	.140	.160	3
MP	3.54	4.08	.139	.161	
Q	2.54	3.42	.100	.135	

LEAD ASSIGNMENTS

- 1- GATE
- 2- DRN
- 3- SOURCE

SEMI CONDUCT

- 1- GATE
- 2- COLLECTOR
- 3- EMITTER

- 1- ANODE
- 2- CATHODE
- 3- ANODE

TO-220AB Part Marking Information

EXAMPLE: THIS IS AN IRF1010
 LOT CODE 1789
 ASSEMBLED ON WW 19, 1997
 IN THE ASSEMBLY LINE 'C'
Note: "P" in assembly line position indicates "Lead-Free"

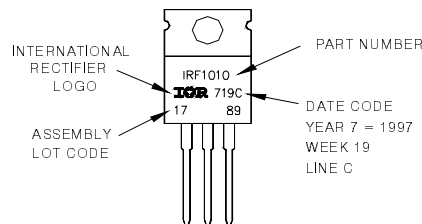

Note: For the most current drawing please refer to IR website at <http://www.irf.com/package/>

Data and specifications subject to change without notice.

International
IR Rectifier

IR WORLD HEADQUARTERS: 233 Kansas St., El Segundo, California 90245, USA Tel: (310) 252-7105
 TAC Fax: (310) 252-7903

Visit us at www.irf.com for sales contact information.02/2010

X-ON Electronics

Largest Supplier of Electrical and Electronic Components

Click to view similar products for [IGBT Transistors](#) category:

Click to view products by [Infineon](#) manufacturer:

Other Similar products are found below :

[748152A](#) [APT20GT60BRDQ1G](#) [APT50GT60BRG](#) [NGTB10N60FG](#) [STGFW20V60DF](#) [APT30GP60BG](#) [APT45GR65B2DU30](#)
[GT50JR22\(STA1ES\)](#) [TIG058E8-TL-H](#) [IGW40N120H3FKSA1](#) [VS-CPV364M4KPBF](#) [NGTB25N120FL2WAG](#) [NGTG40N120FL2WG](#)
[RJH60F3DPQ-A0#T0](#) [APT40GR120B2SCD10](#) [APT15GT120BRG](#) [APT20GT60BRG](#) [NGTB75N65FL2WAG](#) [NGTG15N120FL2WG](#)
[IXA30RG1200DHGLB](#) [IXA40RG1200DHGLB](#) [APT70GR65B2DU40](#) [NTE3320](#) [QP12W05S-37A](#) [IHF40N65R5SXXSA1](#) [APT70GR120J](#)
[APT35GP120JDQ2](#) [XD15H120CX1](#) [XD25H120CX0](#) [XP15PJS120CL1B1](#) [IGW30N60H3FKSA1](#) [STGWA8M120DF3](#) [IGW08T120FKSA1](#)
[IGW75N60H3FKSA1](#) [FGH60N60SMD_F085](#) [FGH75T65UPD](#) [STGWA15H120F2](#) [IKA10N60TXKSA1](#) [IHW20N120R5XKSA1](#)
[RJH60D2DPP-M0#T2](#) [IKP20N60TXKSA1](#) [IHW20N65R5XKSA1](#) [APT70GR120JD60](#) [AOD5B60D](#) [APT70GR120L](#) [STGWT60H65FB](#)
[STGWT60H65DFB](#) [STGWT40V60DF](#) [STGWT20V60DF](#) [STGB10NB37LZT4](#)