

$V_{CES} = 1200V$
 $I_C = 65A, T_C = 100^\circ C$
 $t_{SC} \geq 10\mu s, T_{J(max)} = 150^\circ C$
 $V_{CE(ON)} \text{ typ.} = 1.9V @ I_C = 50A$

Insulated Gate Bipolar Transistor with Ultrafast Soft Recovery Diode

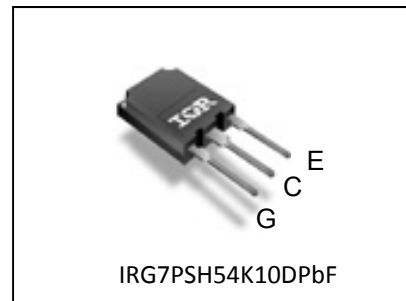
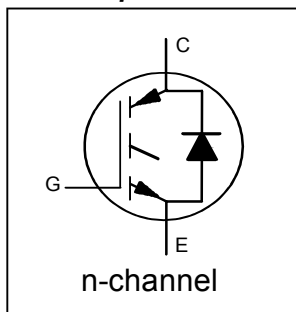

G	C	E
Gate	Collector	Emitter

Applications

- Industrial Motor Drive
- UPS
- Solar Inverters
- Welding

Features	Benefits
Low $V_{CE(ON)}$ and switching losses	High efficiency in a Wide Range of Applications
10 μs Short Circuit SOA	Rugged Transient Performance
Square RBSOA	Increased Reliability
Maximum Junction Temperature 150 $^\circ C$	Excellent Current Sharing in Parallel Operation
Positive $V_{CE(ON)}$ Temperature Coefficient	

Base part number	Package Type	Standard Pack		Orderable Part Number
		Form	Quantity	
IRG7PSH54K10DPbF	Super-247	Tube	25	IRG7PSH54K10DPbF

Absolute Maximum Ratings

	Parameter	Max.	Units
V_{CES}	Collector-to-Emitter Voltage	1200	V
$I_C @ T_C = 25^\circ C$	Continuous Collector Current	120	A
$I_C @ T_C = 100^\circ C$	Continuous Collector Current	65	
I_{CM}	Pulse Collector Current, $V_{GE}=20V$	200	
I_{LM}	Clamped Inductive Load Current, $V_{GE}=20V$ ①	200	
$I_F @ T_C = 25^\circ C$	Diode Continuous Forward Current	50	
$I_F @ T_C = 100^\circ C$	Diode Continuous Forward Current	25	
V_{GE}	Continuous Gate-to-Emitter Voltage	± 30	V
$P_D @ T_C = 25^\circ C$	Maximum Power Dissipation	520	W
$P_D @ T_C = 100^\circ C$	Maximum Power Dissipation	210	
T_J T_{STG}	Operating Junction and Storage Temperature Range	-40 to +150	C
	Soldering Temperature, for 10 sec.	300 (0.063 in. (1.6mm) from case)	
	Mounting Torque, 6-32 or M3 Screw	10 lbf-in (1.1 N·m)	

Thermal Resistance

	Parameter	Min.	Typ.	Max.	Units
$R_{\theta JC}$ (IGBT)	Thermal Resistance Junction-to-Case-(each IGBT) ②	—	—	0.24	$^\circ C/W$
$R_{\theta JC}$ (Diode)	Thermal Resistance Junction-to-Case-(each Diode) ②	—	—	0.70	
$R_{\theta CS}$	Thermal Resistance, Case-to-Sink (flat, greased surface)	—	0.24	—	
$R_{\theta JA}$	Thermal Resistance, Junction-to-Ambient (typical socket mount)	—	—	40	

Electrical Characteristics @ T_J = 25°C (unless otherwise specified)

	Parameter	Min.	Typ.	Max.	Units	Conditions
V _{(BR)CES}	Collector-to-Emitter Breakdown Voltage	1200	—	—	V	V _{GE} = 0V, I _C = 250μA ③
ΔV _{(BR)CES} /ΔT _J	Temperature Coeff. of Breakdown Voltage	—	1.3	—	V/°C	V _{GE} = 0V, I _C = 5mA (25°C-150°C)
V _{CE(on)}	Collector-to-Emitter Saturation Voltage	—	1.9	2.4	V	I _C = 50A, V _{GE} = 15V, T _J = 25°C
		—	2.4	—		I _C = 50A, V _{GE} = 15V, T _J = 150°C
V _{GE(th)}	Gate Threshold Voltage	5.0	—	7.5	V	V _{CE} = V _{GE} , I _C = 2.4mA
ΔV _{GE(th)} /ΔT _J	Threshold Voltage Temperature Coeff.	—	-15	—	mV/°C	V _{CE} = V _{GE} , I _C = 2.4mA (25°C-150°C)
g _{fe}	Forward Transconductance	—	36	—	S	V _{CE} = 50V, I _C = 50A, PW = 20μs
I _{CES}	Collector-to-Emitter Leakage Current	—	1.0	45	μA	V _{GE} = 0V, V _{CE} = 1200V
		—	1800	—		V _{GE} = 0V, V _{CE} = 1200V, T _J = 150°C
I _{GES}	Gate-to-Emitter Leakage Current	—	—	±200	nA	V _{GE} = ±30V
V _F	Diode Forward Voltage Drop	—	2.5	3.5	V	I _F = 16A
		—	2.1	—		I _F = 16A, T _J = 150°C

Switching Characteristics @ T_J = 25°C (unless otherwise specified)

	Parameter	Min.	Typ.	Max④	Units	Conditions
Q _g	Total Gate Charge (turn-on)	—	290	435	nC	I _C = 50A V _{GE} = 15V V _{CC} = 600V
Q _{ge}	Gate-to-Emitter Charge (turn-on)	—	60	90		
Q _{gc}	Gate-to-Collector Charge (turn-on)	—	130	195		
E _{on}	Turn-On Switching Loss	—	4.8	5.7	mJ	I _C = 50A, V _{CC} = 600V, V _{GE} = 15V R _G = 5Ω, T _J = 25°C
E _{off}	Turn-Off Switching Loss	—	2.8	3.7		
E _{total}	Total Switching Loss	—	7.6	9.4		
t _{d(on)}	Turn-On delay time	—	110	130	ns	Energy losses include tail & diode reverse recovery ⑤⑥
t _r	Rise time	—	80	105		
t _{d(off)}	Turn-Off delay time	—	490	520		
t _f	Fall time	—	70	90		
E _{on}	Turn-On Switching Loss	—	6.8	—	mJ	I _C = 50A, V _{CC} = 600V, V _{GE} = 15V R _G = 5Ω, T _J = 150°C
E _{off}	Turn-Off Switching Loss	—	4.7	—		
E _{total}	Total Switching Loss	—	11.5	—		
t _{d(on)}	Turn-On delay time	—	85	—	ns	Energy losses include tail & diode reverse recovery ⑤⑥
t _r	Rise time	—	90	—		
t _{d(off)}	Turn-Off delay time	—	490	—		
t _f	Fall time	—	290	—		
C _{ies}	Input Capacitance	—	5700	—	pF	V _{GE} = 0V V _{CC} = 30V f = 1.0Mhz
C _{oes}	Output Capacitance	—	290	—		
C _{res}	Reverse Transfer Capacitance	—	150	—		
RBSOA	Reverse Bias Safe Operating Area	FULL SQUARE				T _J = 150°C, I _C = 200A V _{CC} = 960V, V _p ≤ 1200V V _{GE} = +20V to 0V
SCSOA	Short Circuit Safe Operating Area	10	—	—	μs	T _J = 150°C, V _{CC} = 600V, V _p ≤ 1200V V _{GE} = +15V to 0V
E _{rec}	Reverse Recovery Energy of the Diode	—	640	—	μJ	T _J = 150°C
t _{rr}	Diode Reverse Recovery Time	—	170	—	ns	V _{CC} = 600V, I _F = 16A
I _{rr}	Peak Reverse Recovery Current	—	25	—	A	V _{GE} = 15V, R _G = 5Ω

Notes:

- ① V_{CC} = 80% (V_{CES}), V_{GE} = 20V
- ② R_θ is measured at T_J of approximately 90°C.
- ③ Refer to AN-1086 for guidelines for measuring V_{(BR)CES} safely.
- ④ Maximum limits are based on statistical sample size characterization.
- ⑤ Pulse width limited by max. junction temperature.
- ⑥ Values influenced by parasitic L and C in measurement.

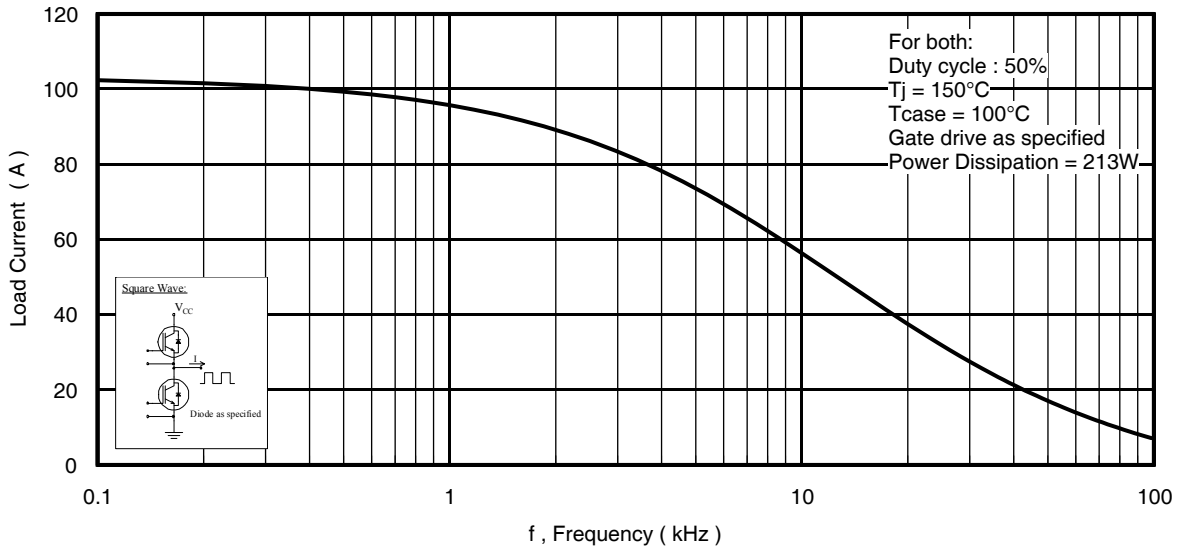

Fig. 1 - Typical Load Current vs. Frequency
(Load Current = I_{RMS} of fundamental)

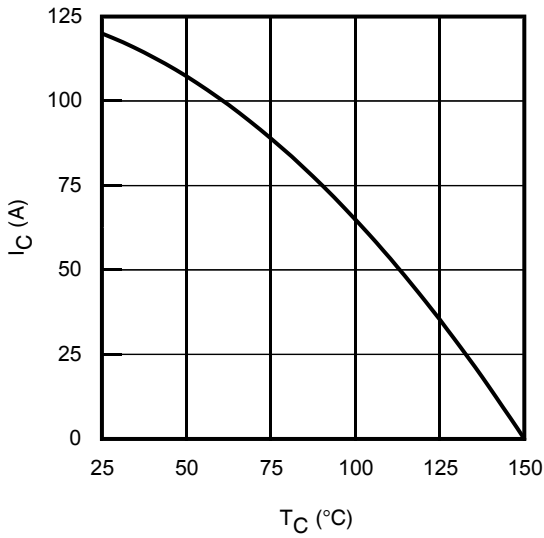

Fig. 2 - Maximum DC Collector Current vs. Case Temperature

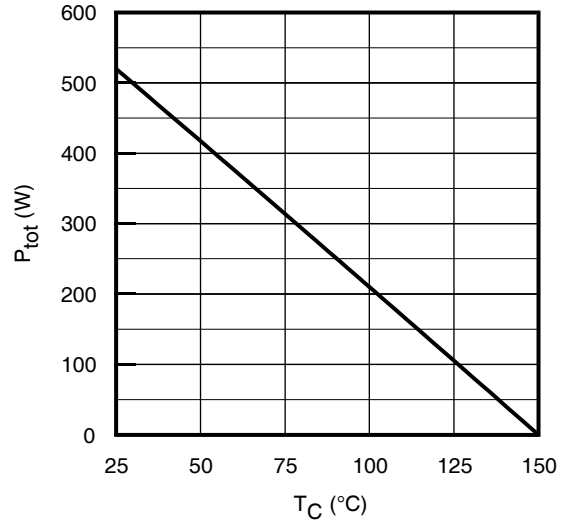

Fig. 3 - Power Dissipation vs. Case Temperature

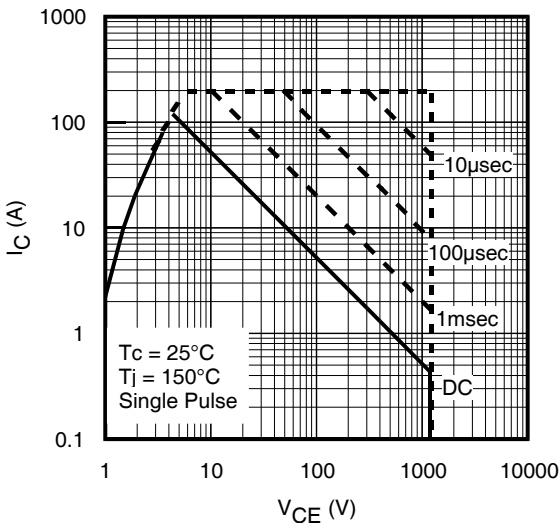

Fig. 4 - Forward SOA
 $T_C = 25^\circ\text{C}$, $T_J \leq 150^\circ\text{C}$, $V_{GE} = 15\text{V}$

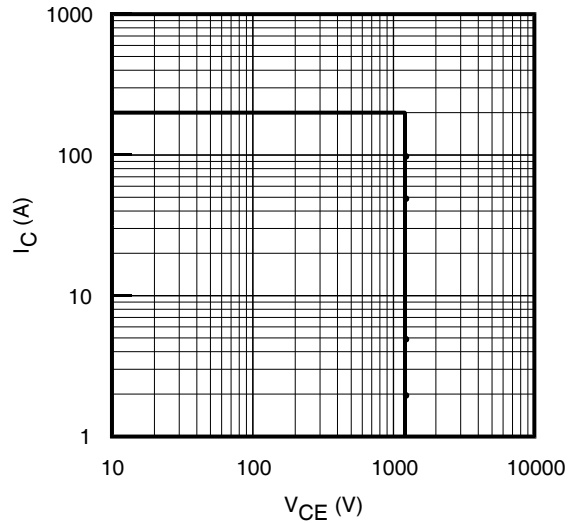

Fig. 5- Reverse Bias SOA
 $T_J = 150^\circ\text{C}$; $V_{GE} = 20\text{V}$

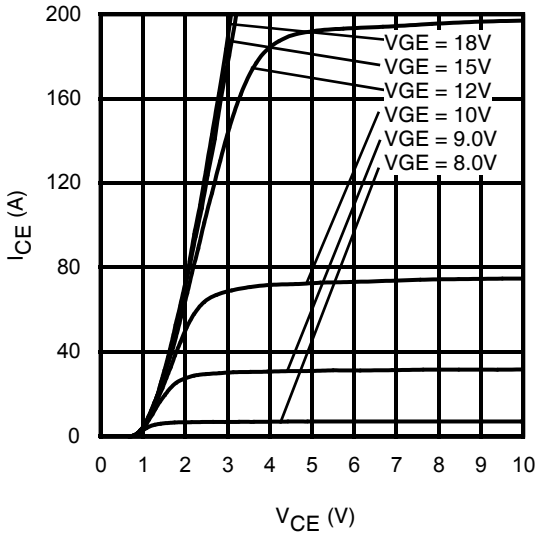

Fig. 6 - Typ. IGBT Output Characteristics
 $T_J = -40^\circ\text{C}$; $t_p = 20\mu\text{s}$

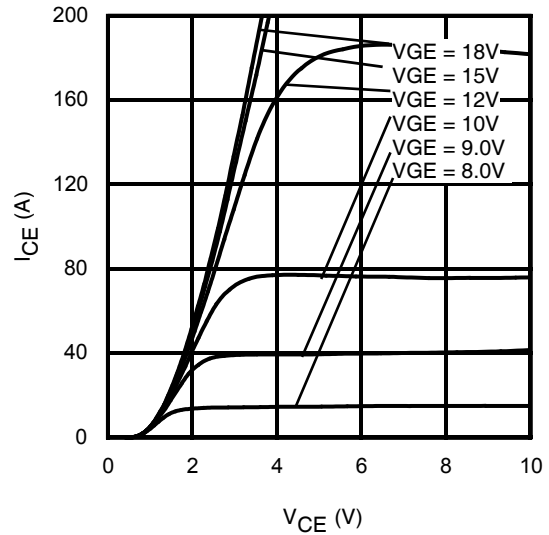

Fig. 7 - Typ. IGBT Output Characteristics
 $T_J = 25^\circ\text{C}$; $t_p = 20\mu\text{s}$

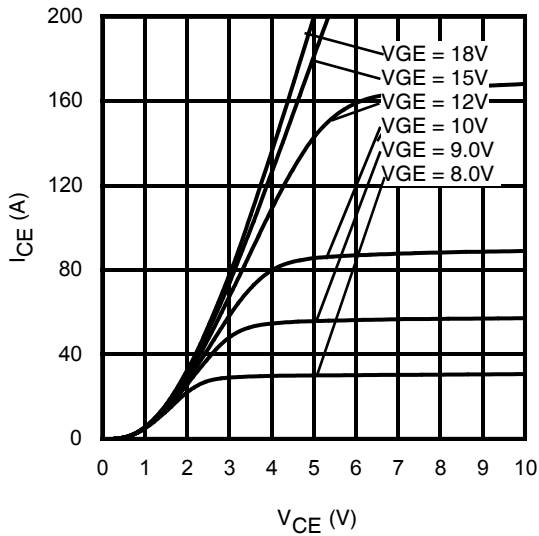

Fig. 8 - Typ. IGBT Output Characteristics
 $T_J = 150^\circ\text{C}$; $t_p = 20\mu\text{s}$

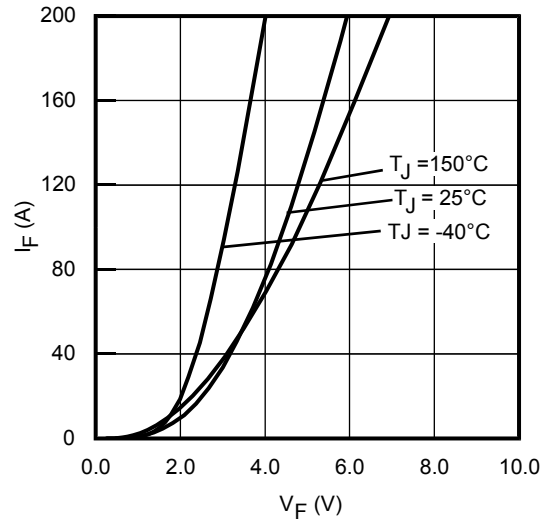

Fig. 9 - Typ. Diode Forward Characteristics
 $t_p = 20\mu\text{s}$

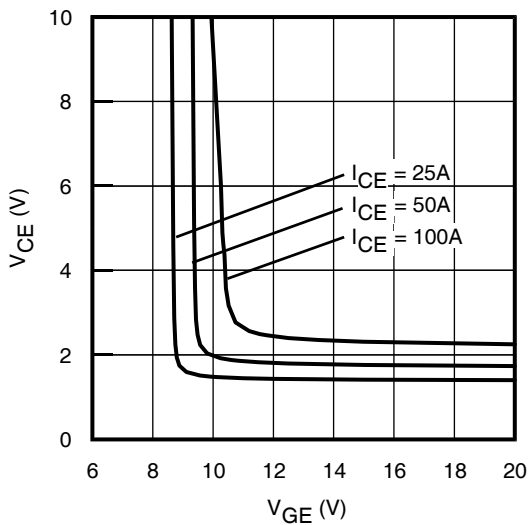

Fig. 10 - Typical V_{CE} vs. V_{GE}
 $T_J = -40^\circ\text{C}$

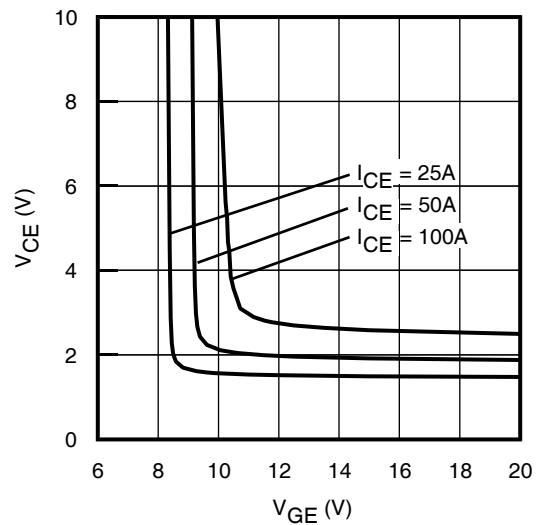

Fig. 11 - Typical V_{CE} vs. V_{GE}
 $T_J = 25^\circ\text{C}$

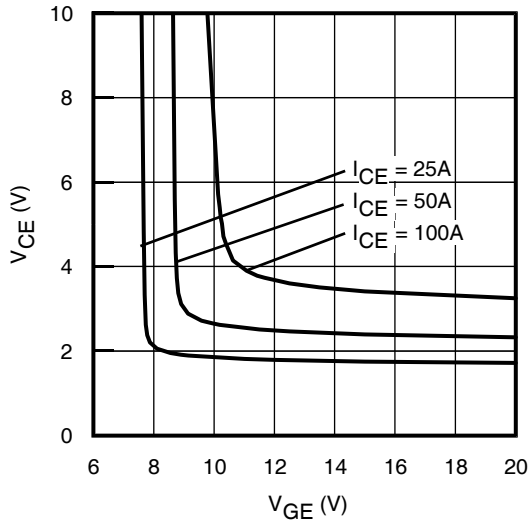

Fig. 12 - Typical V_{CE} vs. V_{GE}
 $T_J = 150^\circ\text{C}$

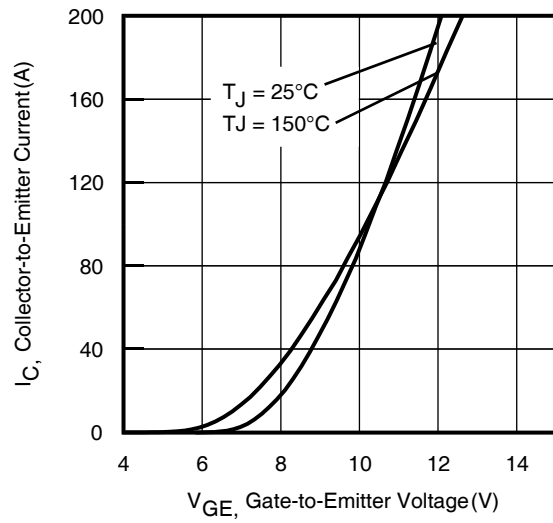

Fig. 13 - Typ. Transfer Characteristics
 $V_{CE} = 50\text{V}; t_p = 20\mu\text{s}$

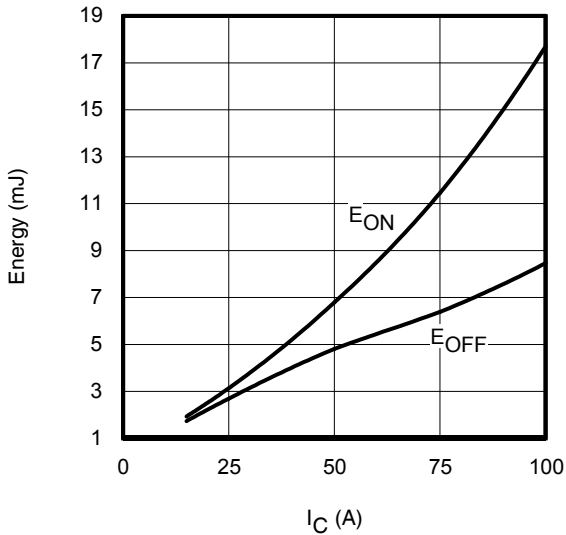

Fig. 14 - Typ. Energy Loss vs. I_C
 $T_J = 150^\circ\text{C}; V_{CE} = 600\text{V}, R_G = 5\Omega; V_{GE} = 15\text{V}$

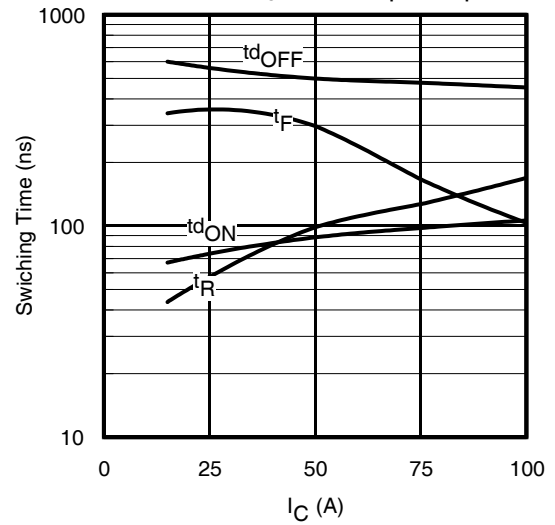

Fig. 15 - Typ. Switching Time vs. I_C
 $T_J = 150^\circ\text{C}; V_{CE} = 600\text{V}, R_G = 5\Omega; V_{GE} = 15\text{V}$

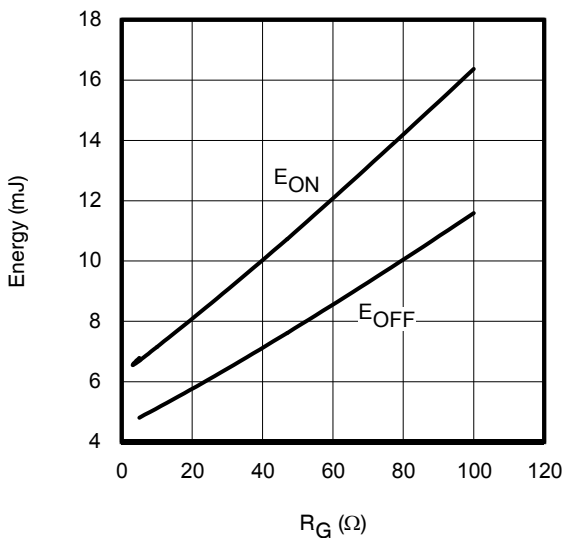

Fig. 16 - Typ. Energy Loss vs. R_G
 $T_J = 150^\circ\text{C}; V_{CE} = 600\text{V}, I_{CE} = 50\text{A}; V_{GE} = 15\text{V}$

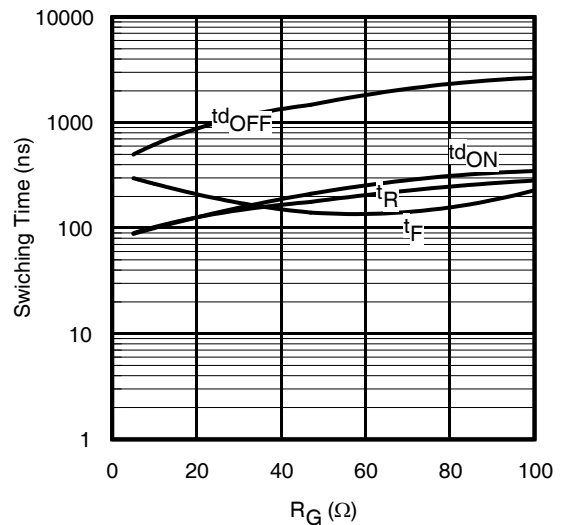

Fig. 17 - Typ. Switching Time vs. R_G
 $T_J = 150^\circ\text{C}; V_{CE} = 600\text{V}, I_{CE} = 50\text{A}; V_{GE} = 15\text{V}$

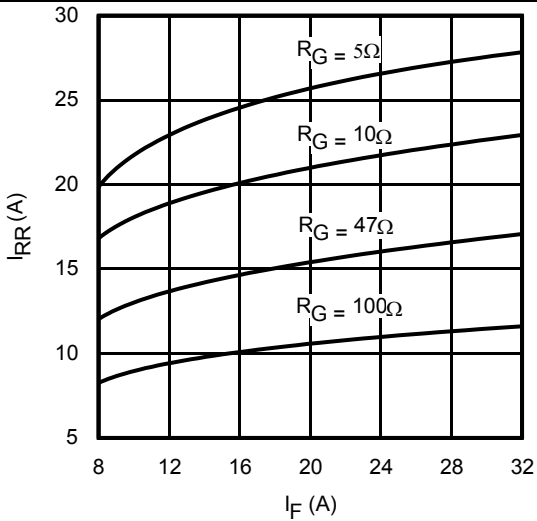

Fig. 18 - Typ. Diode I_{RR} vs. I_F
 $T_J = 150^\circ\text{C}$

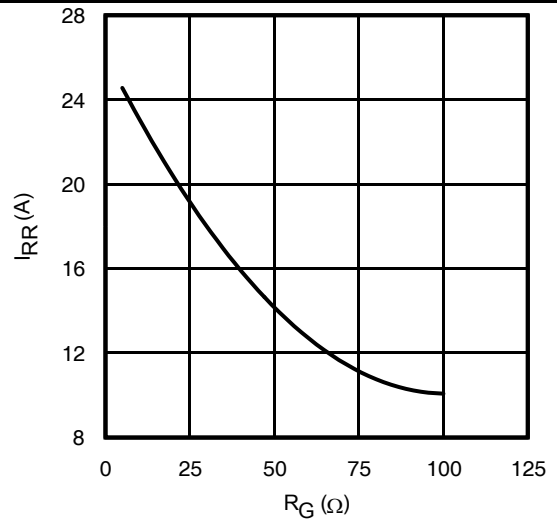

Fig. 19 - Typ. Diode I_{RR} vs. R_G
 $T_J = 150^\circ\text{C}$

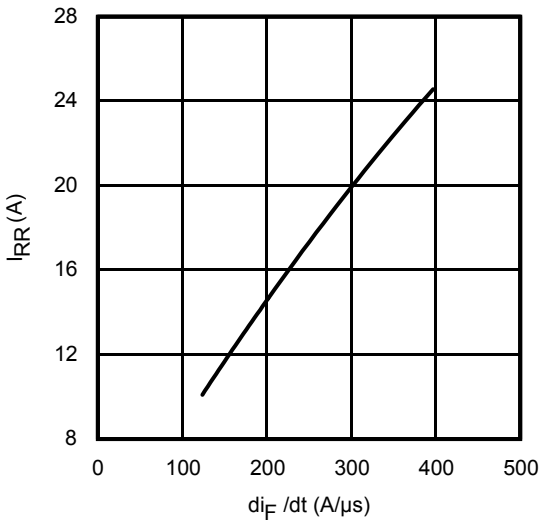

Fig. 20 - Typ. Diode I_{RR} vs. di_F/dt
 $V_{CC} = 600\text{V}$; $V_{GE} = 15\text{V}$; $I_F = 16\text{A}$; $T_J = 150^\circ\text{C}$

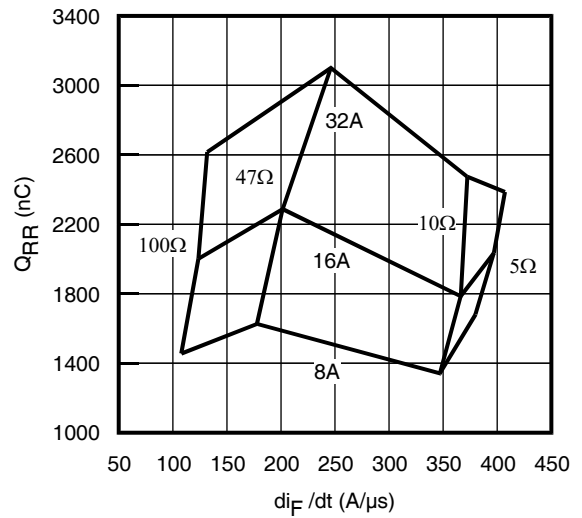

Fig. 21 - Typ. Diode Q_{RR} vs. di_F/dt
 $V_{CC} = 600\text{V}$; $V_{GE} = 15\text{V}$; $T_J = 150^\circ\text{C}$

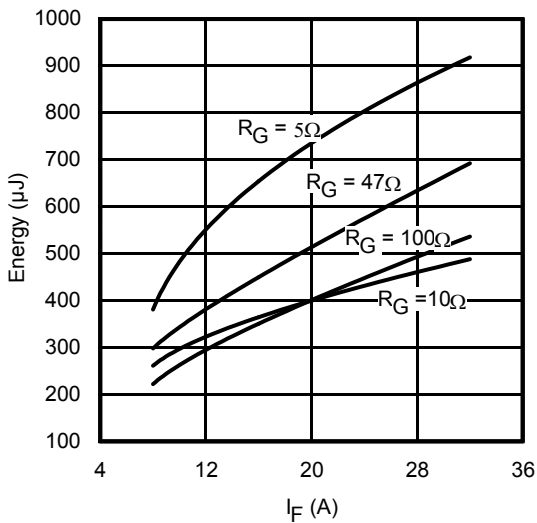

Fig. 22 - Typ. Diode E_{RR} vs. I_F
 $T_J = 150^\circ\text{C}$

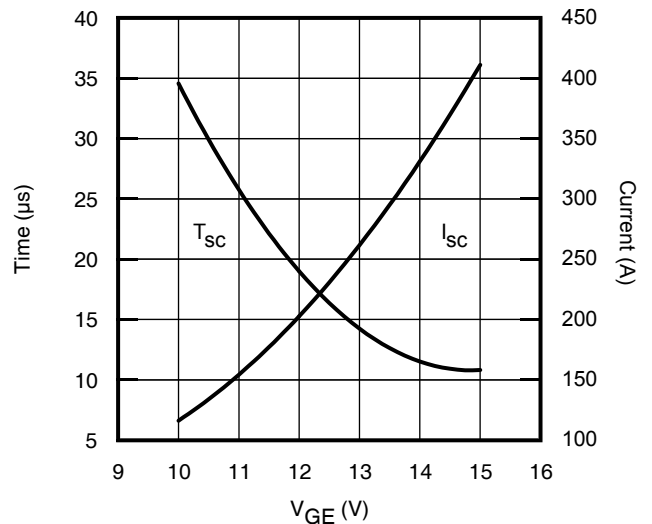

Fig. 23 - V_{CE} vs. Short Circuit Time
 $V_{cc} = 600\text{V}$; $T_C = 150^\circ\text{C}$

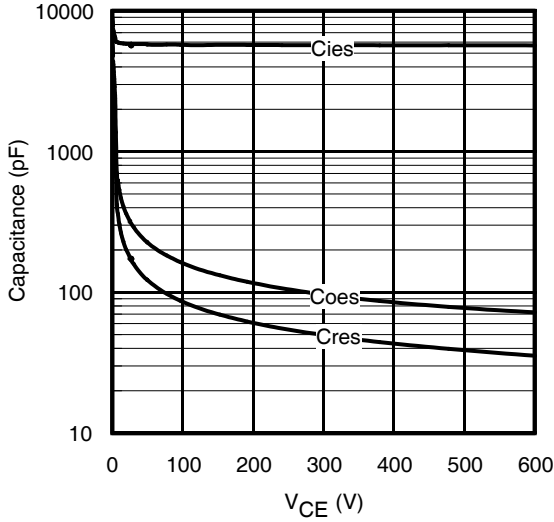

Fig. 24 - Typ. Capacitance vs. V_{CE}
 $V_{GE} = 0V$; $f = 1MHz$

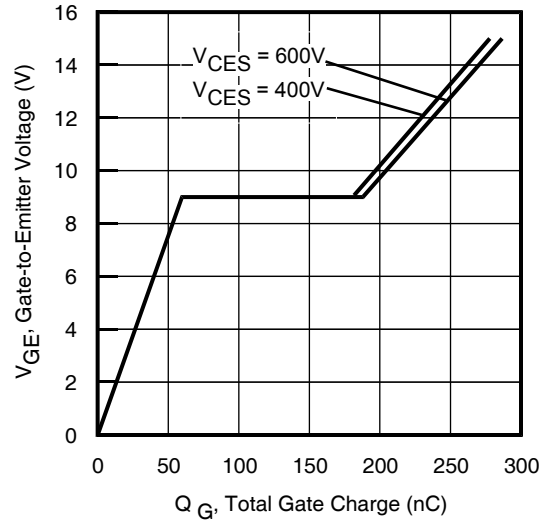

Fig. 25 - Typical Gate Charge vs. V_{GE}
 $I_{CE} = 50A$

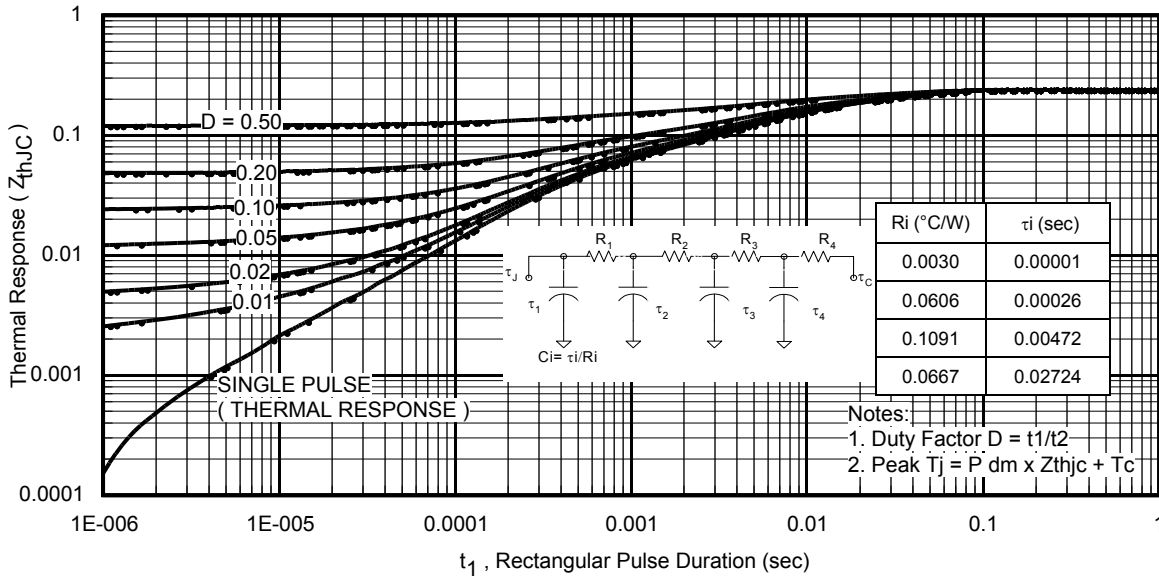

Fig. 26 Maximum Transient Thermal Impedance, Junction-to-Case (IGBT)

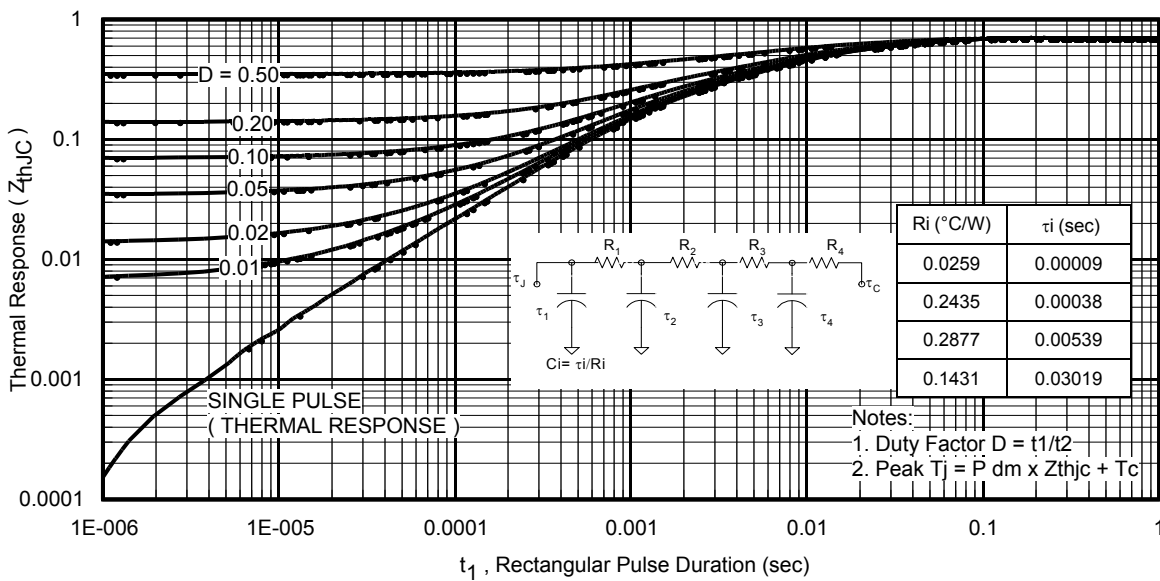
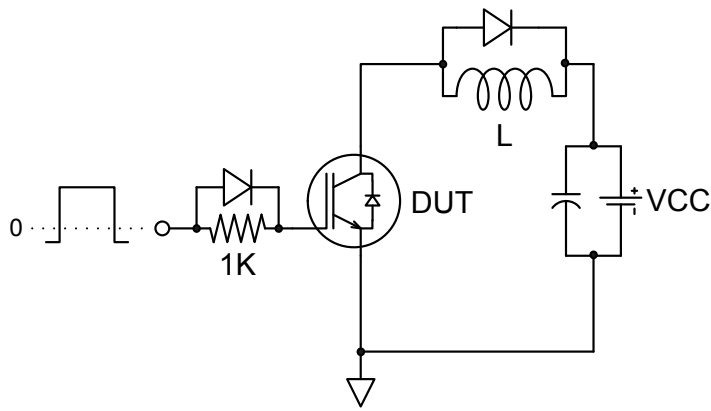
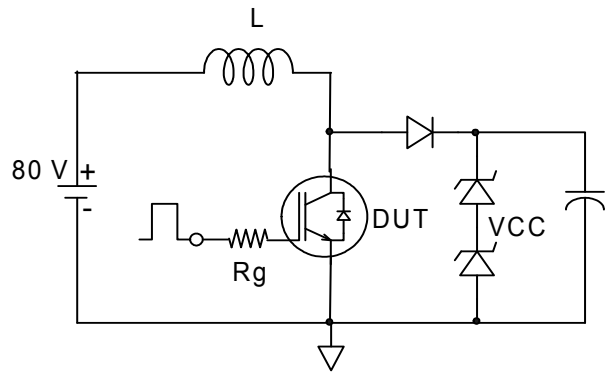
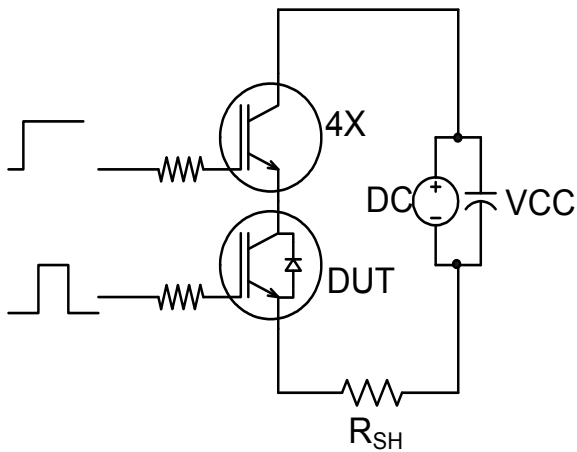
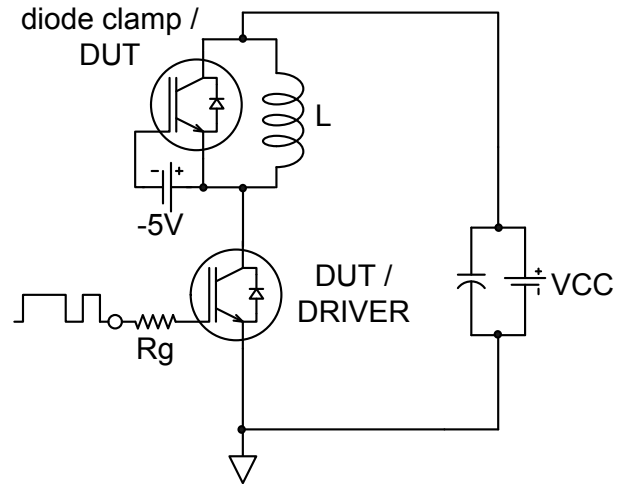
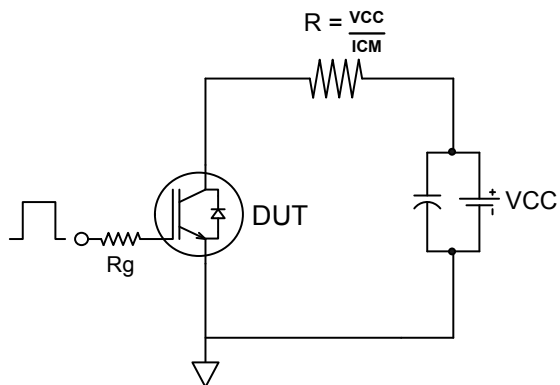
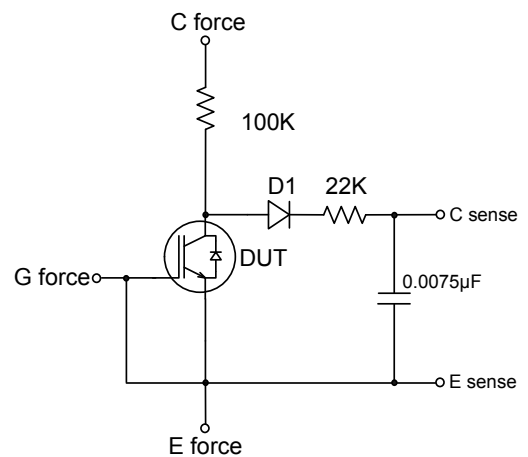

Fig. 27 Maximum Transient Thermal Impedance, Junction-to-Case (DIODE)

Fig.C.T.1 - Gate Charge Circuit (turn-off)

Fig.C.T.2 - RBSOA Circuit

Fig.C.T.3 - S.C. SOA Circuit

Fig.C.T.4 - Switching Loss Circuit

Fig.C.T.5 - Resistive Load Circuit

Fig.C.T.6 - BVCES Filter Circuit

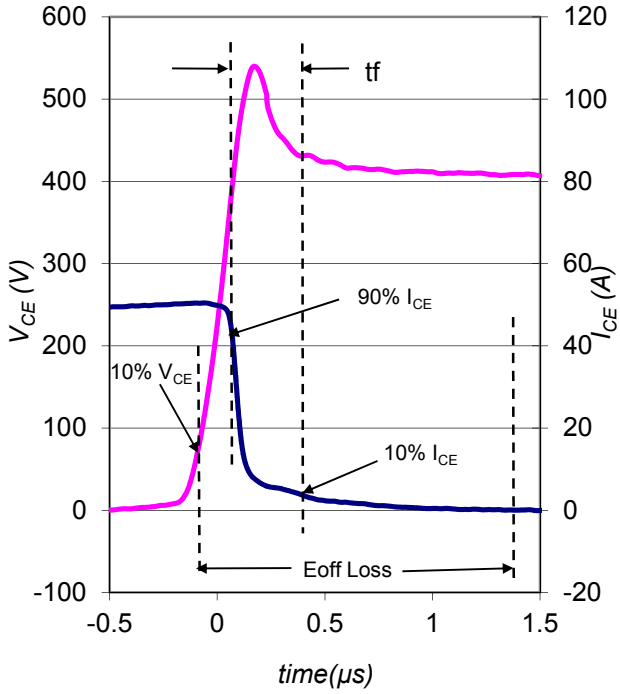

Fig. WF1 - Typ. Turn-off Loss Waveform
@ $T_J = 150^\circ\text{C}$ using Fig. CT.4

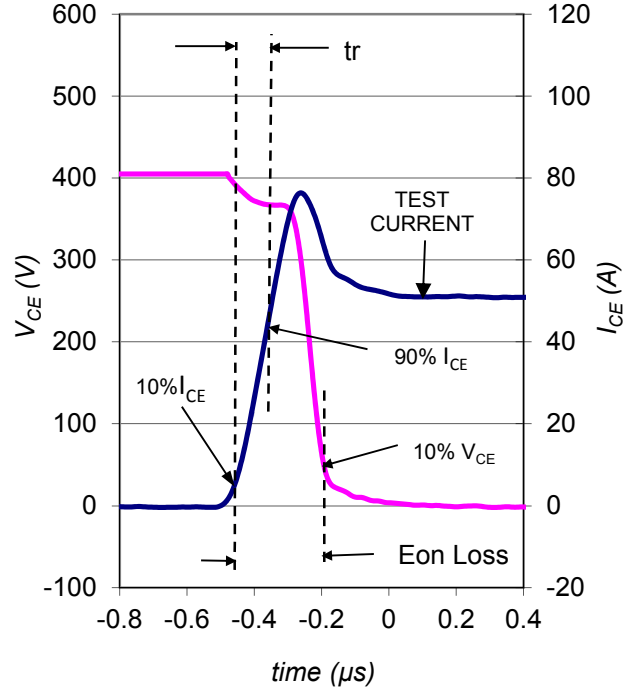

Fig. WF2 - Typ. Turn-on Loss Waveform
@ $T_J = 150^\circ\text{C}$ using Fig. CT.4

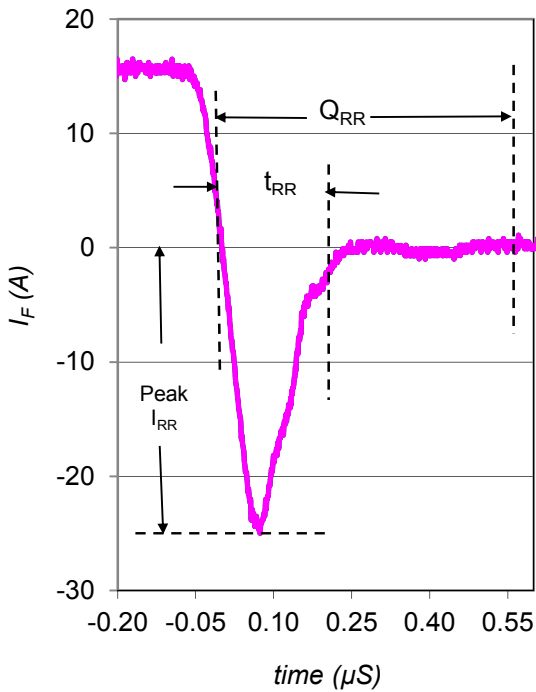

Fig. WF3 - Typ. Diode Recovery Waveform
@ $T_J = 150^\circ\text{C}$ using Fig. CT.4

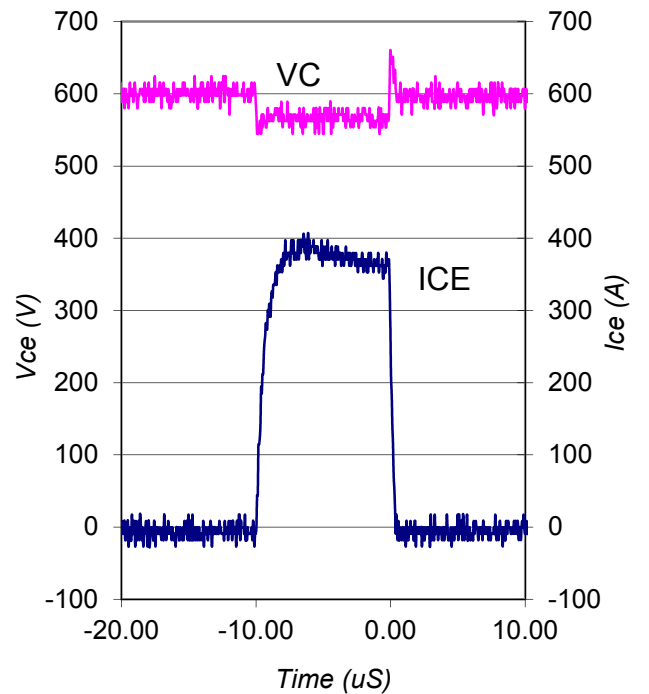
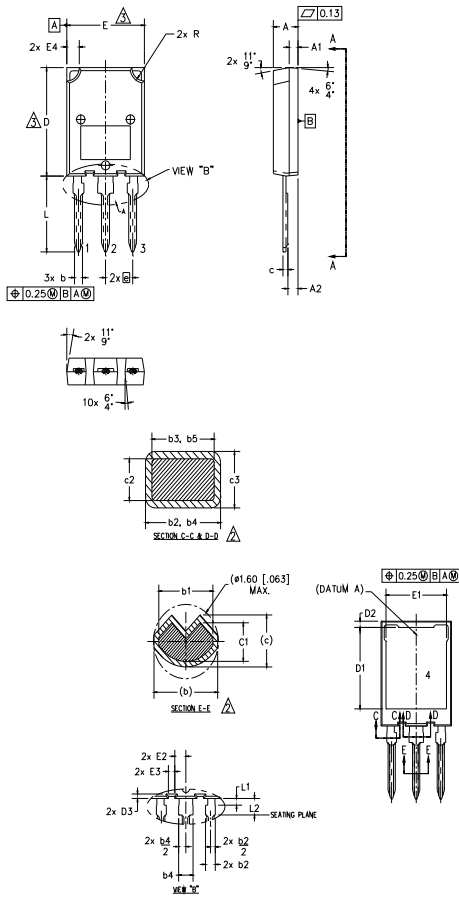

Fig. WF4 - Typ. S.C. Waveform
@ $T_J = 150^\circ\text{C}$ using Fig. CT.3

Super -247(TO-274AA) Package Outline

Dimensions are shown in millimeters (inches)



NOTES:

1. DIMENSIONING AND TOLERANCING AS PER ASME Y14.5M-1994
2. DIMENSIONS b1, b3, b5, c1 & c3 APPLY TO BASE METAL ONLY.
3. DIMENSION D & E DO NOT INCLUDE MOLD FLASH. MOLD FLASH SHALL NOT EXCEED 0.127 [.005"] PER SIDE. THESE DIMENSIONS ARE MEASURED AT THE OUTER EXTREMES OF THE PLASTIC BODY.
4. ALL DIMENSIONS SHOWN IN MILLIMETERS.
5. CONTROLLING DIMENSION: MILLIMETER.
6. OUTLINE CONFORMS TO JEDEC OUTLINE TO-274AA

SYMBOL	DIMENSIONS				NOTES
	MILLIMETERS		INCHES		
	MIN.	MAX.	MIN.	MAX.	
A	4.50	5.50	.177	.217	
A1	1.45	2.15	.057	.085	
A2	1.65	2.35	.065	.093	
b	1.45	1.60	.054	.063	
b1	1.40	1.50	.055	.059	2
b2	2.00	2.40	.079	.094	
b3	1.95	2.35	.077	.093	2
b4	3.00	3.15	.118	.124	
b5	2.95	3.35	.116	.132	2
c	1.10	1.30	.043	.051	
c1	0.90	1.10	.035	.043	2
c2	0.65	0.85	.026	.033	
c3	0.50	0.70	.020	.028	2
D	19.80	20.80	.780	.819	3
D1	15.50	16.10	.610	.634	
D2	0.70	1.30	.028	.051	
D3	0.75	1.25	.030	.049	
E	15.10	16.10	.594	.634	3
E1	13.30	13.90	.524	.547	
E2	2.25	2.70	.089	.109	
E3	1.20	1.70	.047	.067	
E4	2.00	3.00	.079	.118	
e	5.45 BSC		.215 BSC		
L	13.80	14.80	.535	.583	
L1	1.00	1.60	.039	.063	
L2	3.85	4.25	.152	.167	
R	2.00	3.00	.079	.118	

LEAD ASSIGNMENTS

MOSFET

- 1.- GATE
- 2.- DRAIN
- 3.- SOURCE
- 4.- DRAIN

IGBT

- 1.- GATE
- 2.- COLLECTOR
- 3.- EMITTER
- 4.- COLLECTOR

Super -247 (TO-274AA) Part Marking Information

EXAMPLE: THIS IS AN IRFPS37N50A WITH
ASSEMBLY LOT CODE 1789
ASSEMBLED ON WW 19, 1997
IN THE ASSEMBLY LINE "C"

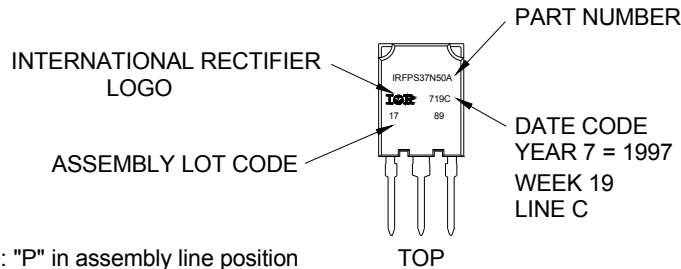

Note: "P" in assembly line position indicates "Lead-Free"

Super -247 package is not recommended for Surface Mount Application.

Note: For the most current drawing please refer to IR website at <http://www.irf.com/package/>

Qualification Information[†]

Qualification Level	Industrial (per JEDEC JESD47F) ^{††}	
Moisture Sensitivity Level	Super-247	N/A
RoHS Compliant	Yes	

† Qualification standards can be found at International Rectifier's web site: <http://www.irf.com/product-info/reliability/>

†† Applicable version of JEDEC standard at the time of product release.

Data and specifications subject to change without notice.

International
 Rectifier

IR WORLD HEADQUARTERS: 101N Sepulveda Blvd., El Segundo, California 90245, USA Tel: (310) 252-7105

TAC Fax: (310) 252-7903

Visit us at www.irf.com for sales contact information.

X-ON Electronics

Largest Supplier of Electrical and Electronic Components

Click to view similar products for [IGBT Transistors](#) category:

Click to view products by [Infineon](#) manufacturer:

Other Similar products are found below :

[748152A](#) [APT20GT60BRDQ1G](#) [APT50GT60BRG](#) [NGTB10N60FG](#) [STGFW20V60DF](#) [APT30GP60BG](#) [APT45GR65B2DU30](#)
[GT50JR22\(STA1ES\)](#) [TIG058E8-TL-H](#) [IGW40N120H3FKSA1](#) [VS-CPV364M4KPBF](#) [NGTB25N120FL2WAG](#) [NGTG40N120FL2WG](#)
[RJH60F3DPQ-A0#T0](#) [APT40GR120B2SCD10](#) [APT15GT120BRG](#) [APT20GT60BRG](#) [NGTB75N65FL2WAG](#) [NGTG15N120FL2WG](#)
[IXA30RG1200DHGLB](#) [IXA40RG1200DHGLB](#) [APT70GR65B2DU40](#) [NTE3320](#) [QP12W05S-37A](#) [IHF40N65R5SXXSA1](#) [APT70GR120J](#)
[APT35GP120JDQ2](#) [XD15H120CX1](#) [XD25H120CX0](#) [XP15PJS120CL1B1](#) [IGW30N60H3FKSA1](#) [STGWA8M120DF3](#) [IGW08T120FKSA1](#)
[IGW75N60H3FKSA1](#) [FGH60N60SMD_F085](#) [FGH75T65UPD](#) [STGWA15H120F2](#) [IKA10N60TXKSA1](#) [IHW20N120R5XKSA1](#)
[RJH60D2DPP-M0#T2](#) [IKP20N60TXKSA1](#) [IHW20N65R5XKSA1](#) [APT70GR120JD60](#) [AOD5B60D](#) [APT70GR120L](#) [STGWT60H65FB](#)
[STGWT60H65DFB](#) [STGWT40V60DF](#) [STGWT20V60DF](#) [STGB10NB37LZT4](#)