

# IRLMS6702PbF

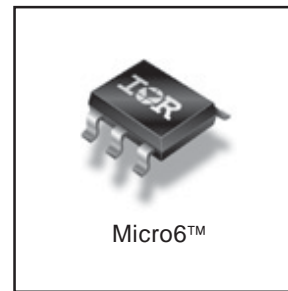
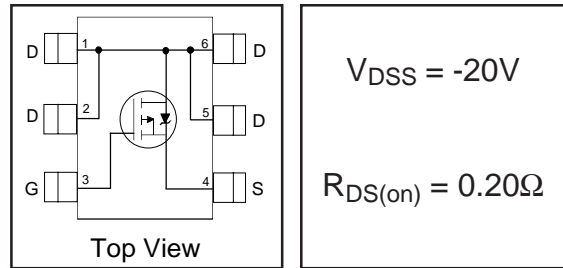
HEXFET<sup>®</sup> Power MOSFET

- Generation V Technology
- Micro6 Package Style
- Ultra Low  $R_{DS(on)}$
- P-Channel MOSFET
- Lead-Free

## Description

Fifth Generation HEXFET<sup>®</sup> power MOSFETs from International Rectifier utilize advanced processing techniques to achieve extremely low on-resistance per silicon area. This benefit, combined with the fast switching speed and ruggedized device design that HEXFET<sup>®</sup> power MOSFETs are well known for, provides the designer with an extremely efficient and reliable device for use in a wide variety of applications.

The Micro6<sup>™</sup> package with its customized leadframe produces a HEXFET<sup>®</sup> power MOSFET with  $R_{DS(on)}$  60% less than a similar size SOT-23. This package is ideal for applications where printed circuit board space is at a premium. It's unique thermal design and  $R_{DS(on)}$  reduction enables a current-handling increase of nearly 300% compared to the SOT-23.



## Absolute Maximum Ratings

|                                | Parameter                                         | Max.         | Units |
|--------------------------------|---------------------------------------------------|--------------|-------|
| $I_D @ T_A = 25^\circ\text{C}$ | Continuous Drain Current, $V_{GS} @ -4.5\text{V}$ | -2.4         | A     |
| $I_D @ T_A = 70^\circ\text{C}$ | Continuous Drain Current, $V_{GS} @ -4.5\text{V}$ | -1.9         |       |
| $I_{DM}$                       | Pulsed Drain Current ①                            | -13          |       |
| $P_D @ T_A = 25^\circ\text{C}$ | Power Dissipation                                 | 1.7          | W     |
|                                | Linear Derating Factor                            | 13           | mW/°C |
| $V_{GS}$                       | Gate-to-Source Voltage                            | $\pm 12$     | V     |
| dv/dt                          | Peak Diode Recovery dv/dt ②                       | 5.0          | V/ns  |
| $T_J, T_{STG}$                 | Junction and Storage Temperature Range            | -55 to + 150 | °C    |

## Thermal Resistance Ratings

|                 | Parameter                     | Min. | Typ. | Max | Units |
|-----------------|-------------------------------|------|------|-----|-------|
| $R_{\theta JA}$ | Maximum Junction-to-Ambient ④ | —    | —    | 75  | °C/W  |

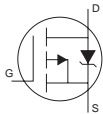
# IRLMS6702PbF

International  
IR Rectifier

## Electrical Characteristics @ T<sub>J</sub> = 25°C (unless otherwise specified)

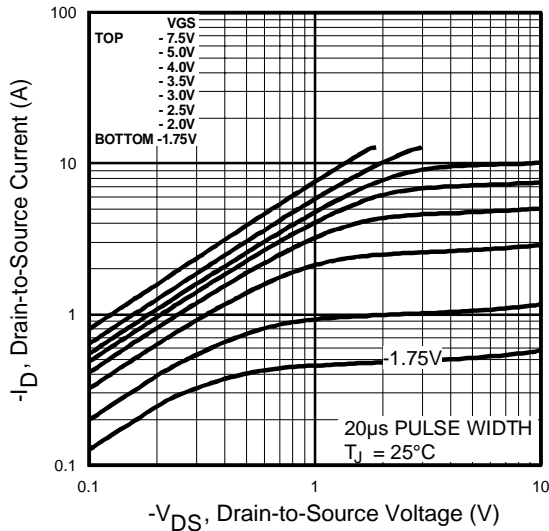
|                                      | Parameter                            | Min.  | Typ.   | Max.  | Units | Conditions                                                           |
|--------------------------------------|--------------------------------------|-------|--------|-------|-------|----------------------------------------------------------------------|
| V <sub>(BR)DSS</sub>                 | Drain-to-Source Breakdown Voltage    | -20   | —      | —     | V     | V <sub>GS</sub> = 0V, I <sub>D</sub> = -250μA                        |
| ΔV <sub>(BR)DSS/ΔT<sub>J</sub></sub> | Breakdown Voltage Temp. Coefficient  | —     | -0.005 | —     | V/°C  | Reference to 25°C, I <sub>D</sub> = -1mA                             |
| R <sub>DS(on)</sub>                  | Static Drain-to-Source On-Resistance | —     | —      | 0.200 | Ω     | V <sub>GS</sub> = -4.5V, I <sub>D</sub> = -1.6A ③                    |
|                                      |                                      | —     | —      | 0.375 |       | V <sub>GS</sub> = -2.7V, I <sub>D</sub> = -0.80A ③                   |
| V <sub>GS(th)</sub>                  | Gate Threshold Voltage               | -0.70 | —      | —     | V     | V <sub>DS</sub> = V <sub>GS</sub> , I <sub>D</sub> = -250μA          |
| g <sub>fs</sub>                      | Forward Transconductance             | 1.5   | —      | —     | S     | V <sub>DS</sub> = -10V, I <sub>D</sub> = -0.80A                      |
| I <sub>DSS</sub>                     | Drain-to-Source Leakage Current      | —     | —      | -1.0  | μA    | V <sub>DS</sub> = -16V, V <sub>GS</sub> = 0V                         |
|                                      |                                      | —     | —      | -25   |       | V <sub>DS</sub> = -16V, V <sub>GS</sub> = 0V, T <sub>J</sub> = 125°C |
| I <sub>GSS</sub>                     | Gate-to-Source Forward Leakage       | —     | —      | -100  | nA    | V <sub>GS</sub> = -12V                                               |
|                                      | Gate-to-Source Reverse Leakage       | —     | —      | 100   |       | V <sub>GS</sub> = 12V                                                |
| Q <sub>g</sub>                       | Total Gate Charge                    | —     | 5.8    | 8.8   | nC    | I <sub>D</sub> = -1.6A                                               |
| Q <sub>gs</sub>                      | Gate-to-Source Charge                | —     | 1.8    | 2.6   |       | V <sub>DS</sub> = -16V                                               |
| Q <sub>gd</sub>                      | Gate-to-Drain ("Miller") Charge      | —     | 2.1    | 3.1   |       | V <sub>GS</sub> = -4.5V, See Fig. 6 and 9 ③                          |
| t <sub>d(on)</sub>                   | Turn-On Delay Time                   | —     | 13     | —     | ns    | V <sub>DD</sub> = -10V                                               |
| t <sub>r</sub>                       | Rise Time                            | —     | 20     | —     |       | I <sub>D</sub> = -1.6A                                               |
| t <sub>d(off)</sub>                  | Turn-Off Delay Time                  | —     | 21     | —     |       | R <sub>G</sub> = 6.0Ω                                                |
| t <sub>f</sub>                       | Fall Time                            | —     | 18     | —     |       | R <sub>D</sub> = 6.1Ω, See Fig. 10 ③                                 |
| C <sub>iss</sub>                     | Input Capacitance                    | —     | 210    | —     | pF    | V <sub>GS</sub> = 0V                                                 |
| C <sub>oss</sub>                     | Output Capacitance                   | —     | 130    | —     |       | V <sub>DS</sub> = -15V                                               |
| C <sub>rss</sub>                     | Reverse Transfer Capacitance         | —     | 73     | —     |       | f = 1.0MHz, See Fig. 5                                               |

## Source-Drain Ratings and Characteristics

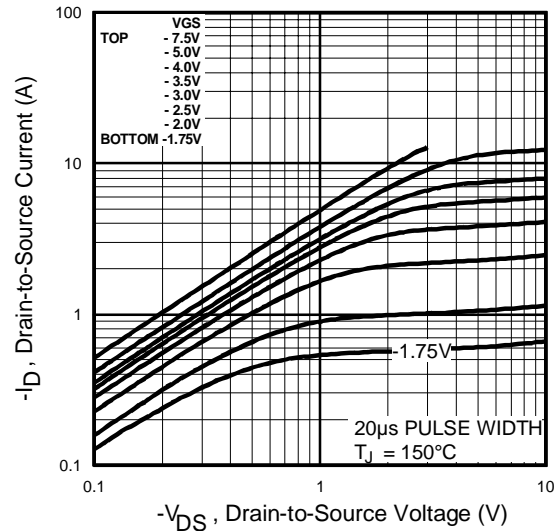
|                 | Parameter                              | Min. | Typ. | Max. | Units | Conditions                                                                                                                                           |
|-----------------|----------------------------------------|------|------|------|-------|------------------------------------------------------------------------------------------------------------------------------------------------------|
| I <sub>S</sub>  | Continuous Source Current (Body Diode) | —    | —    | -1.7 | A     | MOSFET symbol showing the integral reverse p-n junction diode.  |
| I <sub>SM</sub> | Pulsed Source Current (Body Diode) ①   | —    | —    | -13  |       |                                                                                                                                                      |
| V <sub>SD</sub> | Diode Forward Voltage                  | —    | —    | -1.2 | V     | T <sub>J</sub> = 25°C, I <sub>S</sub> = -1.6A, V <sub>GS</sub> = 0V ③                                                                                |
| t <sub>rr</sub> | Reverse Recovery Time                  | —    | 25   | 37   | ns    | T <sub>J</sub> = 25°C, I <sub>F</sub> = -1.6A                                                                                                        |
| Q <sub>rr</sub> | Reverse Recovery Charge                | —    | 15   | 22   | nC    | di/dt = -100A/μs ③                                                                                                                                   |

### Notes:

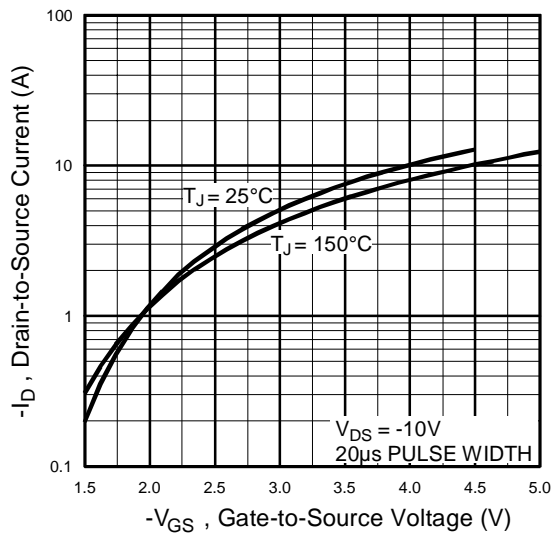
- ① Repetitive rating; pulse width limited by max. junction temperature. ( See fig. 11 )
- ② I<sub>SD</sub> ≤ -1.6A, di/dt ≤ -100A/μs, V<sub>DD</sub> ≤ V<sub>(BR)DSS</sub>, T<sub>J</sub> ≤ 150°C
- ③ Pulse width ≤ 300μs; duty cycle ≤ 2%.
- ④ Surface mounted on FR-4 board, t ≤ 5sec.



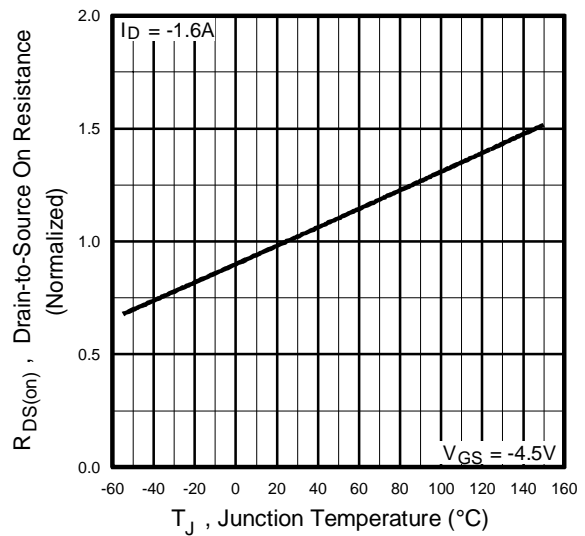
**Fig 1.** Typical Output Characteristics



**Fig 2.** Typical Output Characteristics

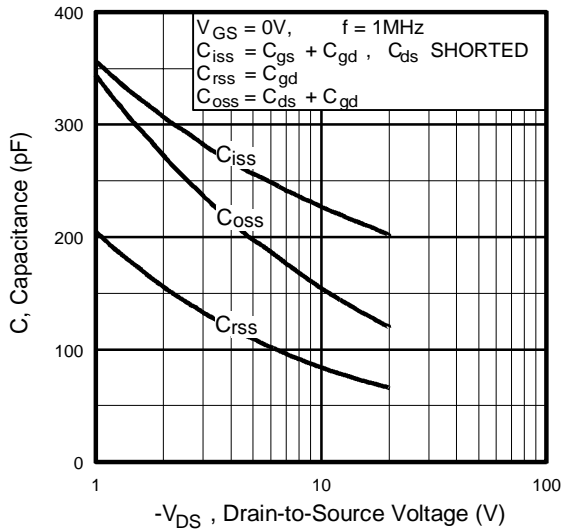


**Fig 3.** Typical Transfer Characteristics

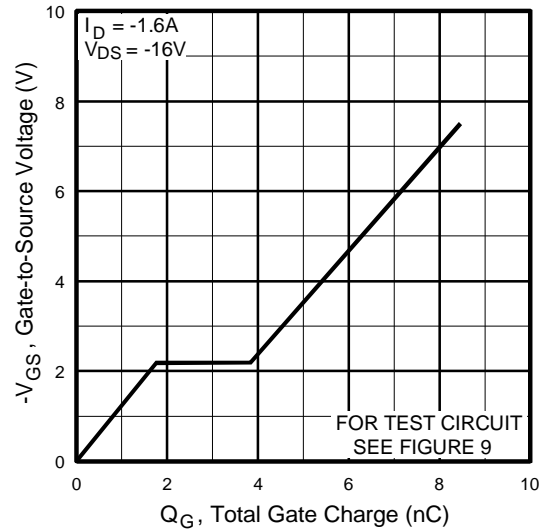


**Fig 4.** Normalized On-Resistance Vs. Temperature

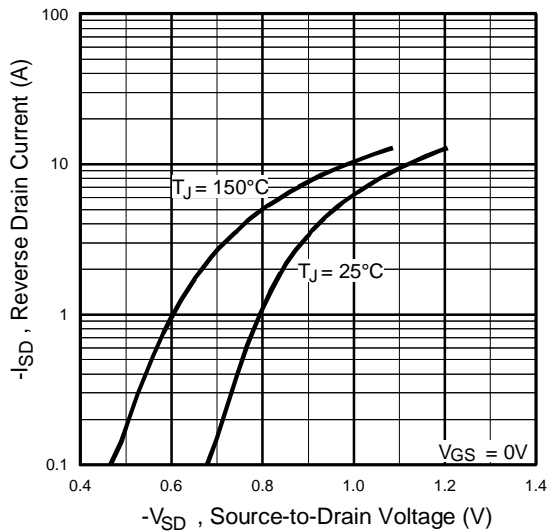
# IRLMS6702PbF



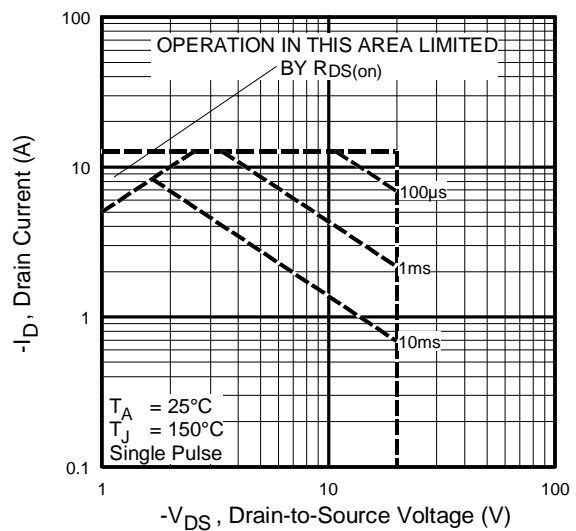
**Fig 5.** Typical Capacitance Vs. Drain-to-Source Voltage



**Fig 6.** Typical Gate Charge Vs. Gate-to-Source Voltage



**Fig 7.** Typical Source-Drain Diode Forward Voltage



**Fig 8.** Maximum Safe Operating Area

# IRLMS6702PbF

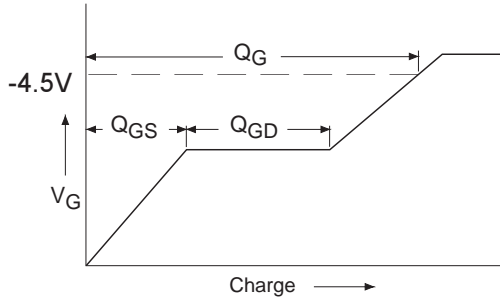


Fig 9a. Basic Gate Charge Waveform

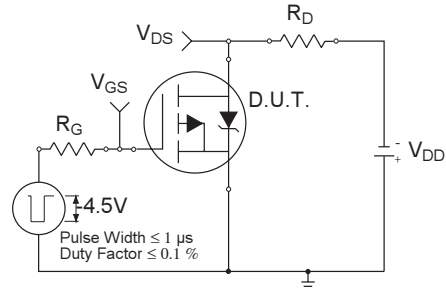


Fig 10a. Switching Time Test Circuit

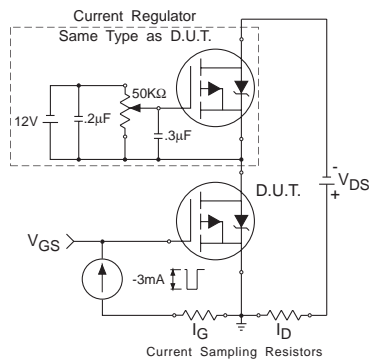


Fig 9b. Gate Charge Test Circuit

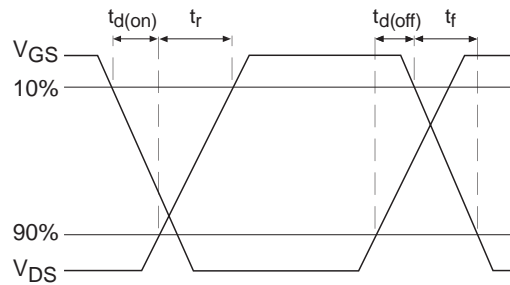


Fig 10b. Switching Time Waveforms

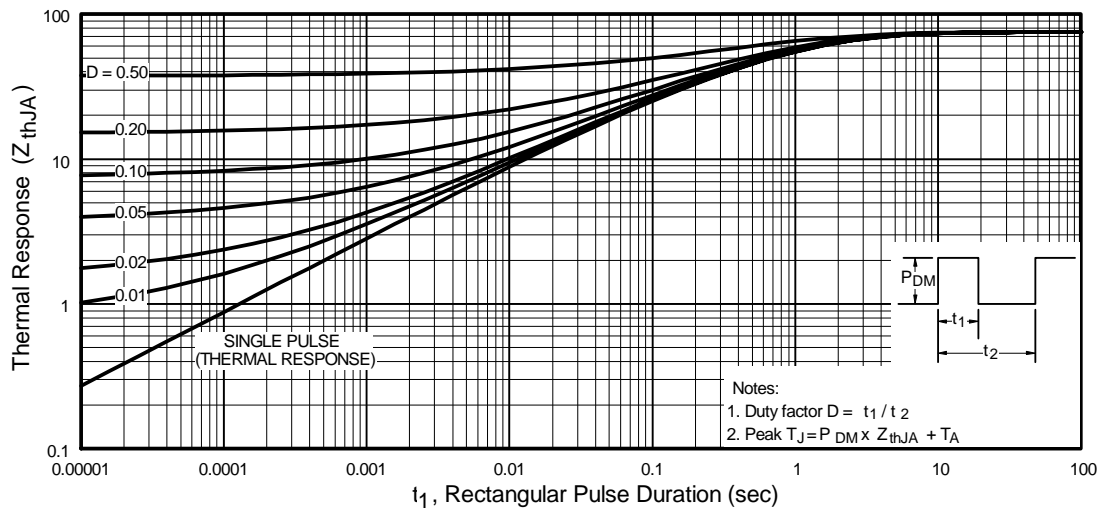
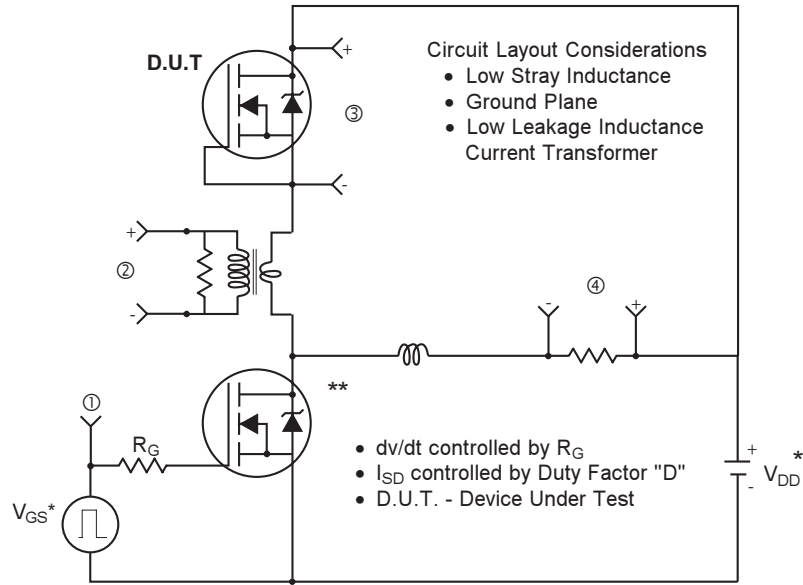
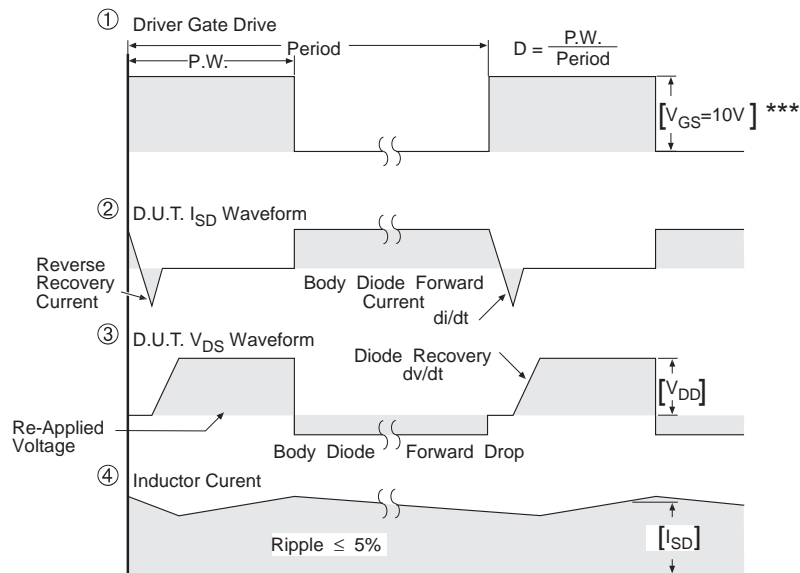


Fig 11. Maximum Effective Transient Thermal Impedance, Junction-to-Ambient

## Peak Diode Recovery dv/dt Test Circuit



\* Reverse Polarity of D.U.T for P-Channel

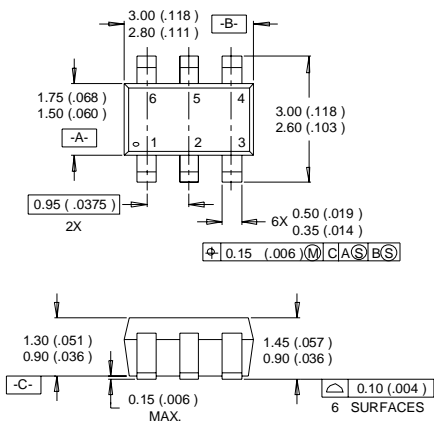


\*\*\*  $V_{GS} = 5.0V$  for Logic Level and 3V Drive Devices

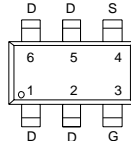
**Fig 12.** For P-channel HEXFET® power MOSFETs

## Micro6 (SOT23 6L) Package Outline

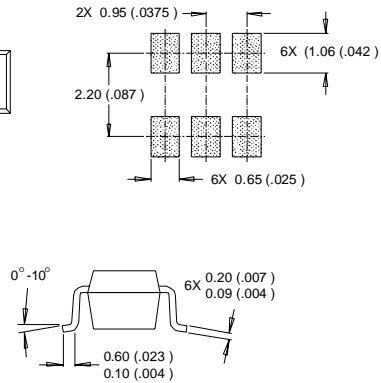
Dimensions are shown in millimeters (inches)



### LEAD ASSIGNMENTS



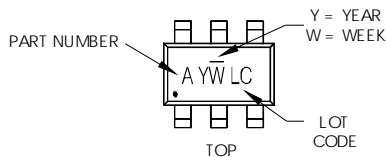
### RECOMMENDED FOOTPRINT



- NOTES :
1. DIMENSIONING & TOLERANCING PER ANSI Y14.5M-1982.
  2. CONTROLLING DIMENSION : MILLIMETER.
  3. DIMENSIONS ARE SHOWN IN MILLIMETERS (INCHES).

## Micro6 (SOT23 6L) Part Marking Information

W = (1-26) IF PRECEDED BY LAST DIGIT OF CALENDAR YEAR



### PART NUMBER CODE REFERENCE:

- A = IRLMS 1902
- B = IRLMS 1503
- C = IRLMS 6702
- D = IRLMS 5703
- E = IRLMS 6802
- F = IRLMS 4502
- G = IRLMS 2002
- H = IRLMS 6803

Note: A line above the work week (as shown here) indicates Lead-Free.

| YEAR | Y | WORK WEEK | W |
|------|---|-----------|---|
| 2001 | 1 | 01        | A |
| 2002 | 2 | 02        | B |
| 2003 | 3 | 03        | C |
| 2004 | 4 | 04        | D |
| 2005 | 5 |           |   |
| 2006 | 6 |           |   |
| 2007 | 7 |           |   |
| 2008 | 8 |           |   |
| 2009 | 9 |           |   |
| 2010 | 0 | 24        | X |
|      |   | 25        | Y |
|      |   | 26        | Z |

W = (27-52) IF PRECEDED BY A LETTER

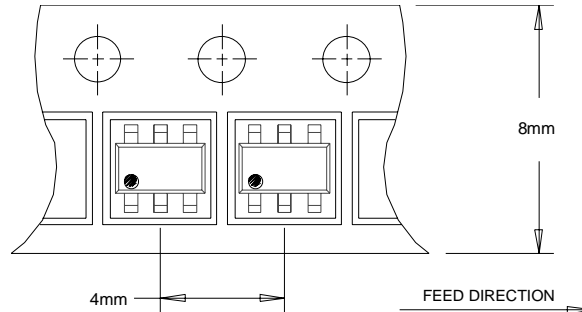
| YEAR | Y | WORK WEEK | W |
|------|---|-----------|---|
| 2001 | A | 27        | A |
| 2002 | B | 28        | B |
| 2003 | C | 29        | C |
| 2004 | D | 30        | D |
| 2005 | E |           |   |
| 2006 | F |           |   |
| 2007 | G |           |   |
| 2008 | H |           |   |
| 2009 | J |           |   |
| 2010 | K | 50        | X |
|      |   | 51        | Y |
|      |   | 52        | Z |

# IRLMS6702PbF

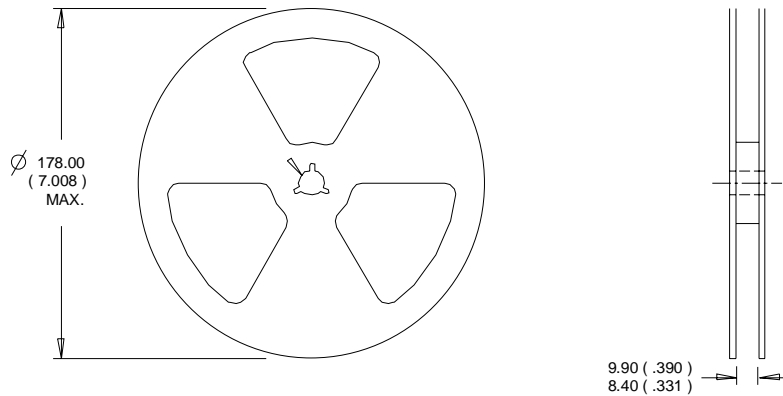
International  
**IR** Rectifier

## Micro6 Tape & Reel Information

Dimensions are shown in millimeters (inches)



NOTES:  
1. OUTLINE CONFORMS TO EIA-481 & EIA-541.



NOTES:  
1. CONTROLLING DIMENSION : MILLIMETER.  
2. OUTLINE CONFORMS TO EIA-481 & EIA-541.

This product has been designed and qualified for the consumer market.  
Qualification Standards can be found on IR's Web site.

Data and specifications subject to change without notice.

International  
**IR** Rectifier

IR WORLD HEADQUARTERS: 233 Kansas St., El Segundo, California 90245, USA Tel: (310) 252-7105  
TAC Fax: (310) 252-7903

Visit us at [www.irf.com](http://www.irf.com) for sales contact information **01/05**

[www.irf.com](http://www.irf.com)



## **IMPORTANT NOTICE**

The information given in this document shall in no event be regarded as a guarantee of conditions or characteristics ("Beschaffheitsgarantie").

With respect to any examples, hints or any typical values stated herein and/or any information regarding the application of the product, Infineon Technologies hereby disclaims any and all warranties and liabilities of any kind, including without limitation warranties of non-infringement of intellectual property rights of any third party.

In addition, any information given in this document is subject to customer's compliance with its obligations stated in this document and any applicable legal requirements, norms and standards concerning customer's products and any use of the product of Infineon Technologies in customer's applications.

The data contained in this document is exclusively intended for technically trained staff. It is the responsibility of customer's technical departments to evaluate the suitability of the product for the intended application and the completeness of the product information given in this document with respect to such application.

For further information on the product, technology, delivery terms and conditions and prices please contact your nearest Infineon Technologies office ([www.infineon.com](http://www.infineon.com)).

## **WARNINGS**

Due to technical requirements products may contain dangerous substances. For information on the types in question please contact your nearest Infineon Technologies office.

Except as otherwise explicitly approved by Infineon Technologies in a written document signed by authorized representatives of Infineon Technologies, Infineon Technologies' products may not be used in any applications where a failure of the product or any consequences of the use thereof can reasonably be expected to result in personal injury.

## X-ON Electronics

Largest Supplier of Electrical and Electronic Components

*Click to view similar products for [MOSFET](#) category:*

*Click to view products by [Infineon](#) manufacturer:*

Other Similar products are found below :

[614233C](#) [648584F](#) [IRFD120](#) [JANTX2N5237](#) [FCA20N60\\_F109](#) [FDZ595PZ](#) [2SK2545\(Q,T\)](#) [405094E](#) [423220D](#) [TPCC8103,L1Q\(CM](#)  
[MIC4420CM-TR](#) [VN1206L](#) [614234A](#) [715780A](#) [NTNS3166NZT5G](#) [SSM6J414TU,LF\(T](#) [751625C](#) [BUK954R8-60E](#) [GROUP A 5962-](#)  
[8877003PA](#) [NTE6400](#) [SQJ402EP-T1-GE3](#) [2SK2614\(TE16L1,Q\)](#) [2N7002KW-FAI](#) [DMN1017UCP3-7](#) [EFC2J004NUZTDG](#) [ECH8691-TL-W](#)  
[FCAB21350L1](#) [P85W28HP2F-7071](#) [DMN1053UCP4-7](#) [NTE221](#) [NTE222](#) [NTE2384](#) [NTE2903](#) [NTE2941](#) [NTE2945](#) [NTE2946](#) [NTE2960](#)  
[NTE2967](#) [NTE2969](#) [NTE2976](#) [NTE6400A](#) [NTE2910](#) [NTE2916](#) [NTE2956](#) [NTE2911](#) [DMN2080UCB4-7](#) [TK10A80W,S4X\(S](#)  
[SSM6P69NU,LF](#) [DMP22D4UFO-7B](#) [DMN1006UCA6-7](#)