

# IRLP3034PbF

HEXFET® Power MOSFET

## Applications

- DC Motor Drive
- High Efficiency Synchronous Rectification in SMPS
- Uninterruptible Power Supply
- High Speed Power Switching
- Hard Switched and High Frequency Circuits

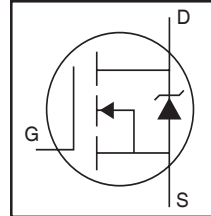

|                         |      |               |
|-------------------------|------|---------------|
| $V_{DSS}$               |      | <b>40V</b>    |
| $R_{DS(on)}$            | typ. | <b>1.4mΩ</b>  |
|                         | max. | <b>1.7mΩ</b>  |
| $I_D$ (Silicon Limited) |      | <b>327A</b> ① |
| $I_D$ (Package Limited) |      | <b>195A</b>   |

## Benefits

- Optimized for Logic Level Drive
- Very Low  $R_{DS(ON)}$  at 4.5V  $V_{GS}$
- Superior  $R^*Q$  at 4.5V  $V_{GS}$
- Improved Gate, Avalanche and Dynamic  $dV/dt$  Ruggedness
- Fully Characterized Capacitance and Avalanche SOA
- Enhanced body diode  $dV/dt$  and  $dI/dt$  Capability
- Lead-Free

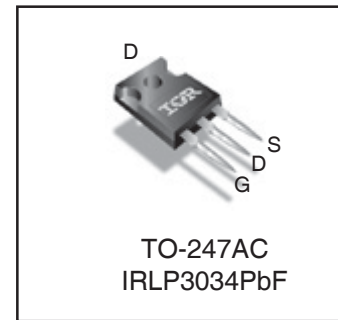

|          |          |          |
|----------|----------|----------|
| <b>G</b> | <b>D</b> | <b>S</b> |
| Gate     | Drain    | Source   |

## Absolute Maximum Ratings

| Symbol                          | Parameter   | Max.              | Units |
|---------------------------------|---|-------------------|-------|
| $I_D @ T_C = 25^\circ\text{C}$  | Continuous Drain Current, $V_{GS} @ 10\text{V}$ (Silicon Limited) | 327 ①             | A     |
| $I_D @ T_C = 100^\circ\text{C}$ | Continuous Drain Current, $V_{GS} @ 10\text{V}$ (Silicon Limited) | 232 ①             |       |
| $I_D @ T_C = 25^\circ\text{C}$  | Continuous Drain Current, $V_{GS} @ 10\text{V}$ (Package Limited) | 195               |       |
| $I_{DM}$                        | Pulsed Drain Current ②  | 1308              |       |
| $P_D @ T_C = 25^\circ\text{C}$  | Maximum Power Dissipation   | 341               | W     |
|                                 | Linear Derating Factor  | 2.3               | W/°C  |
| $V_{GS}$                        | Gate-to-Source Voltage  | ±20               | V     |
| $dv/dt$                         | Peak Diode Recovery ④   | 4.6               | V/ns  |
| $T_J$<br>$T_{STG}$              | Operating Junction and<br>Storage Temperature Range               | -55 to +175       | °C    |
|                                 | Soldering Temperature, for 10 seconds<br>(1.6mm from case)        | 300               |       |
|                                 | Mounting torque, 6-32 or M3 screw                                 | 10lbf·in (1.1N·m) |       |

## Avalanche Characteristics

|                              |                                 |                            |    |
|------------------------------|---------------------------------|----------------------------|----|
| $E_{AS}$ (Thermally limited) | Single Pulse Avalanche Energy ③ | 224                        | mJ |
| $I_{AR}$                     | Avalanche Current ②             | See Fig. 14, 15, 22a, 22b, | A  |
| $E_{AR}$                     | Repetitive Avalanche Energy ②   |                            | mJ |

## Thermal Resistance

| Symbol          | Parameter                           | Typ. | Max. | Units |
|-----------------|-------------------------------------|------|------|-------|
| $R_{\theta JC}$ | Junction-to-Case ③                  | —    | 0.44 | °C/W  |
| $R_{\theta CS}$ | Case-to-Sink, Flat, Greased Surface | 0.24 | —    |       |
| $R_{\theta JA}$ | Junction-to-Ambient                 | —    | 40   |       |

Static @  $T_J = 25^\circ\text{C}$  (unless otherwise specified)

| Symbol                          | Parameter                            | Min. | Typ. | Max. | Units               | Conditions   |
|---------------------------------|--------------------------------------|------|------|------|---------------------|--|
| $V_{(BR)DSS}$                   | Drain-to-Source Breakdown Voltage    | 40   | —    | —    | V                   | $V_{GS} = 0V, I_D = 250\mu A$                        |
| $\Delta V_{(BR)DSS}/\Delta T_J$ | Breakdown Voltage Temp. Coefficient  | —    | 0.04 | —    | V/ $^\circ\text{C}$ | Reference to $25^\circ\text{C}$ , $I_D = 5mA$ ②      |
| $R_{DS(on)}$                    | Static Drain-to-Source On-Resistance | —    | 1.4  | 1.7  | m $\Omega$          | $V_{GS} = 10V, I_D = 195A$ ③                         |
|                                 |                                      | —    | 1.6  | 2.0  |                     | $V_{GS} = 4.5V, I_D = 172A$ ③                        |
| $V_{GS(th)}$                    | Gate Threshold Voltage               | 1.0  | —    | 2.5  | V                   | $V_{DS} = V_{GS}, I_D = 250\mu A$                    |
| $I_{DSS}$                       | Drain-to-Source Leakage Current      | —    | —    | 20   | $\mu A$             | $V_{DS} = 40V, V_{GS} = 0V$                          |
|                                 |                                      | —    | —    | 250  |                     | $V_{DS} = 40V, V_{GS} = 0V, T_J = 125^\circ\text{C}$ |
| $I_{GSS}$                       | Gate-to-Source Forward Leakage       | —    | —    | 100  | nA                  | $V_{GS} = 20V$                                       |
|                                 | Gate-to-Source Reverse Leakage       | —    | —    | -100 |                     | $V_{GS} = -20V$                                      |
| $R_{G(int)}$                    | Internal Gate Resistance             | —    | 2.1  | —    | $\Omega$            |  |

Dynamic @  $T_J = 25^\circ\text{C}$  (unless otherwise specified)

| Symbol              | Parameter                                       | Min. | Typ.  | Max. | Units | Conditions                               |
|---------------------|---|------|-------|------|-------|--|
| gfs                 | Forward Transconductance                        | 286  | —     | —    | S     | $V_{DS} = 10V, I_D = 195A$               |
| $Q_g$               | Total Gate Charge                               | —    | 108   | 162  | nC    | $I_D = 185A$                             |
| $Q_{gs}$            | Gate-to-Source Charge                           | —    | 29    | —    |       | $V_{DS} = 20V$                           |
| $Q_{gd}$            | Gate-to-Drain ("Miller") Charge                 | —    | 54    | —    |       | $V_{GS} = 4.5V$ ⑤                        |
| $Q_{sync}$          | Total Gate Charge Sync. ( $Q_g - Q_{gd}$ )      | —    | 54    | —    |       | $I_D = 185A, V_{DS} = 0V, V_{GS} = 4.5V$ |
| $t_{d(on)}$         | Turn-On Delay Time                              | —    | 65    | —    | ns    | $V_{DD} = 26V$                           |
| $t_r$               | Rise Time                                       | —    | 827   | —    |       | $I_D = 195A$                             |
| $t_{d(off)}$        | Turn-Off Delay Time                             | —    | 97    | —    |       | $R_G = 2.1\Omega$                        |
| $t_f$               | Fall Time                                       | —    | 355   | —    |       | $V_{GS} = 4.5V$ ⑤                        |
| $C_{iss}$           | Input Capacitance                               | —    | 10315 | —    | pF    | $V_{GS} = 0V$                            |
| $C_{oss}$           | Output Capacitance                              | —    | 1980  | —    |       | $V_{DS} = 25V$                           |
| $C_{rss}$           | Reverse Transfer Capacitance                    | —    | 935   | —    |       | $f = 1.0MHz$                             |
| $C_{oss}$ eff. (ER) | Effective Output Capacitance (Energy Related) ⑦ | —    | 2378  | —    |       | $V_{GS} = 0V, V_{DS} = 0V$ to $32V$ ⑦    |
| $C_{oss}$ eff. (TR) | Effective Output Capacitance (Time Related) ⑧   | —    | 2986  | —    |       | $V_{GS} = 0V, V_{DS} = 0V$ to $32V$ ⑧    |

## Diode Characteristics

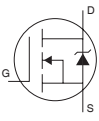
| Symbol    | Parameter                                 | Min.   | Typ. | Max.  | Units | Conditions   |
|-----------|---|--|------|-------|-------|--|
| $I_S$     | Continuous Source Current<br>(Body Diode) | —  | —    | 327 ① | A     | MOSFET symbol showing the integral reverse p-n junction diode.  |
| $I_{SM}$  | Pulsed Source Current<br>(Body Diode) ②   | —  | —    | 1308  |       |  |
| $V_{SD}$  | Diode Forward Voltage                     | —  | —    | 1.3   | V     | $T_J = 25^\circ\text{C}, I_S = 195A, V_{GS} = 0V$ ⑤  |
| $t_{rr}$  | Reverse Recovery Time                     | —  | 39   | —     | ns    | $T_J = 25^\circ\text{C}$ $V_R = 34V,$  |
|           |   | —  | 41   | —     |       | $T_J = 125^\circ\text{C}$ $I_F = 195A$   |
| $Q_{rr}$  | Reverse Recovery Charge                   | —  | 39   | —     | nC    | $T_J = 25^\circ\text{C}$ $di/dt = 100A/\mu s$ ⑤  |
|           |   | —  | 46   | —     |       | $T_J = 125^\circ\text{C}$  |
| $I_{RRM}$ | Reverse Recovery Current                  | —  | 1.7  | —     | A     | $T_J = 25^\circ\text{C}$   |
| $t_{on}$  | Forward Turn-On Time                      | Intrinsic turn-on time is negligible (turn-on is dominated by LS+LD) |      |       |       |  |

## Notes:

- ① Calculated continuous current based on maximum allowable junction temperature Bond wire current limit is 195A. Note that current limitation arising from heating of the device leads may occur with some lead mounting arrangements.
- ② Repetitive rating; pulse width limited by max. junction temperature.
- ③ Limited by  $T_{Jmax}$ , starting  $T_J = 25^\circ\text{C}$ ,  $L = 0.013mH$   
 $R_G = 25\Omega, I_{AS} = 195A, V_{GS} = 10V$ . Part not recommended for use above this value.
- ④  $I_{SD} \leq 195A, di/dt \leq 841A/\mu s, V_{DD} \leq V_{(BR)DSS}, T_J \leq 175^\circ\text{C}$ .

⑤ Pulse width  $\leq 400\mu s$ ; duty cycle  $\leq 2\%$ .

⑥  $C_{oss}$  eff. (TR) is a fixed capacitance that gives the same charging time as  $C_{oss}$  while  $V_{DS}$  is rising from 0 to 80%  $V_{DSS}$ .

⑦  $C_{oss}$  eff. (ER) is a fixed capacitance that gives the same energy as  $C_{oss}$  while  $V_{DS}$  is rising from 0 to 80%  $V_{DSS}$ .

⑧  $R_G$  is measured at  $T_J$  approximately  $90^\circ\text{C}$

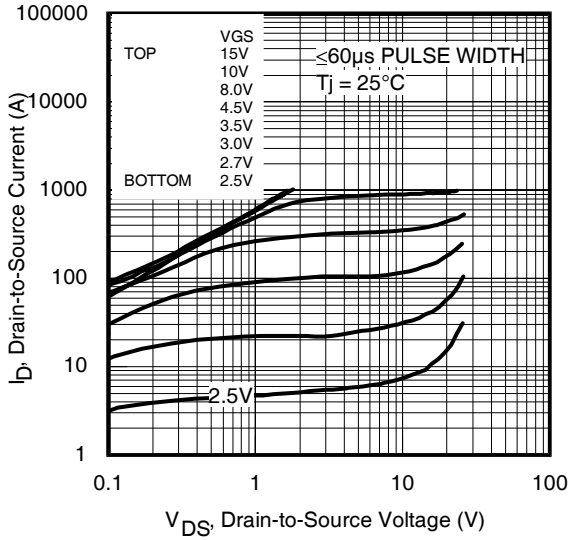

Fig 1. Typical Output Characteristics

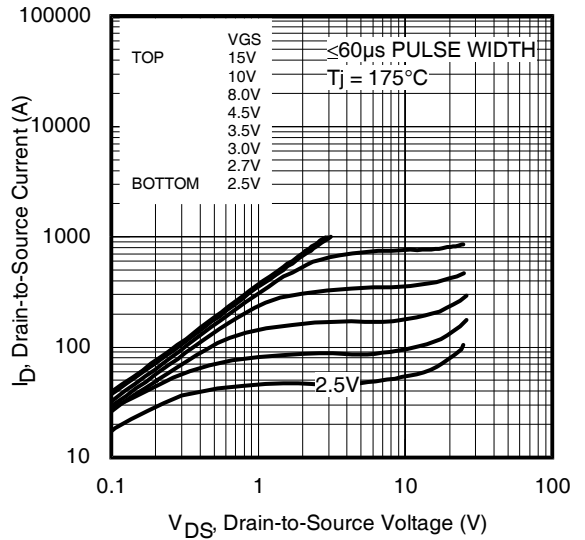

Fig 2. Typical Output Characteristics

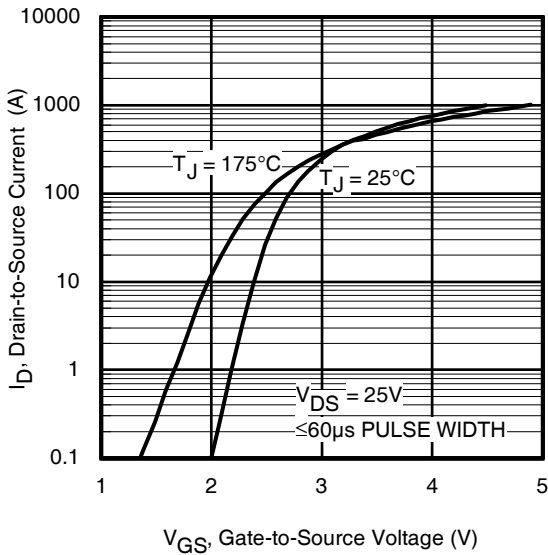

Fig 3. Typical Transfer Characteristics

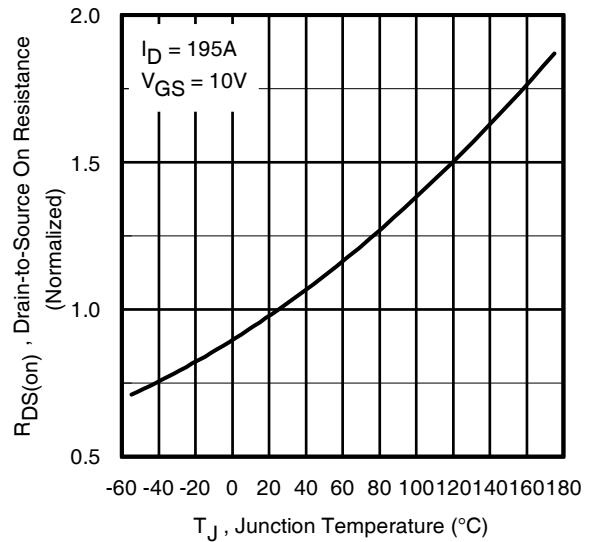

Fig 4. Normalized On-Resistance vs. Temperature

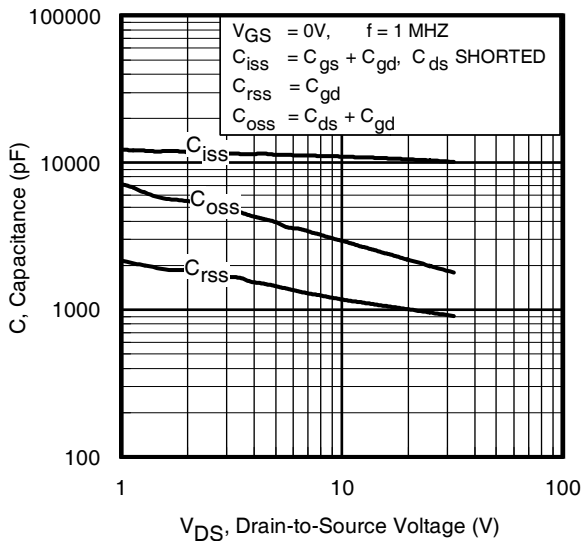

Fig 5. Typical Capacitance vs. Drain-to-Source Voltage

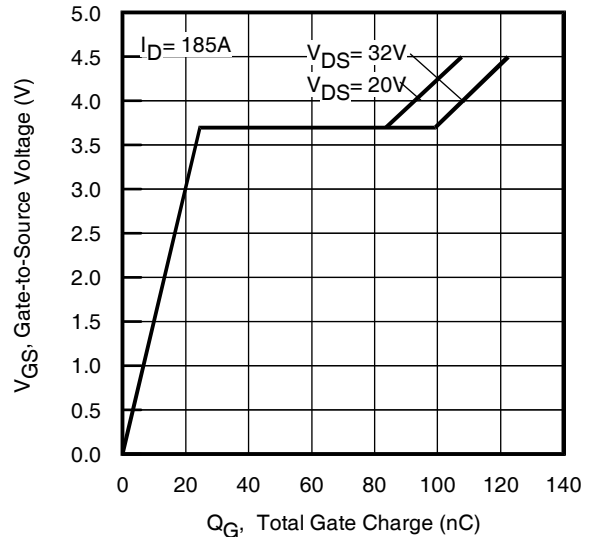
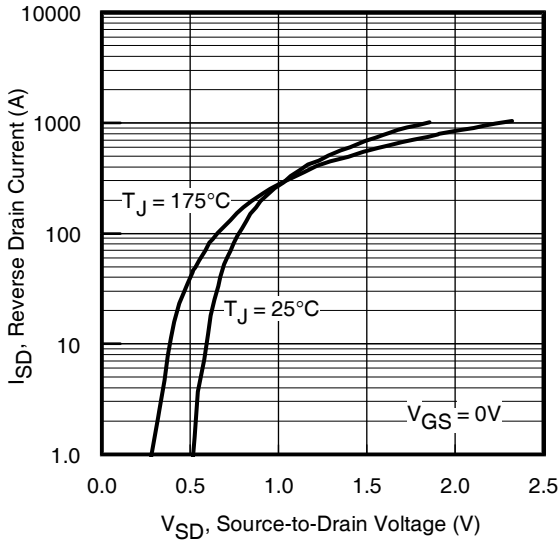
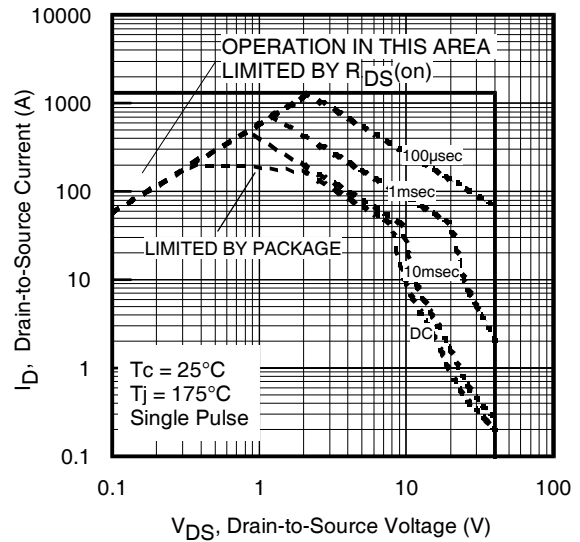

Fig 6. Typical Gate Charge vs. Gate-to-Source Voltage



**Fig 7.** Typical Source-Drain Diode Forward Voltage



**Fig 8.** Maximum Safe Operating Area

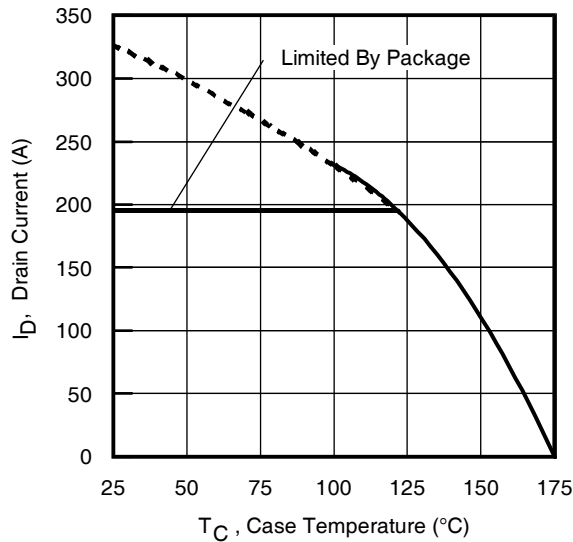

**Fig 9.** Maximum Drain Current vs. Case Temperature

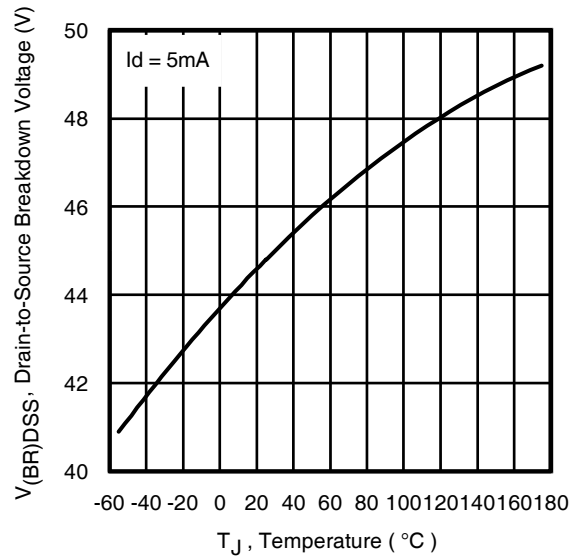

**Fig 10.** Drain-to-Source Breakdown Voltage

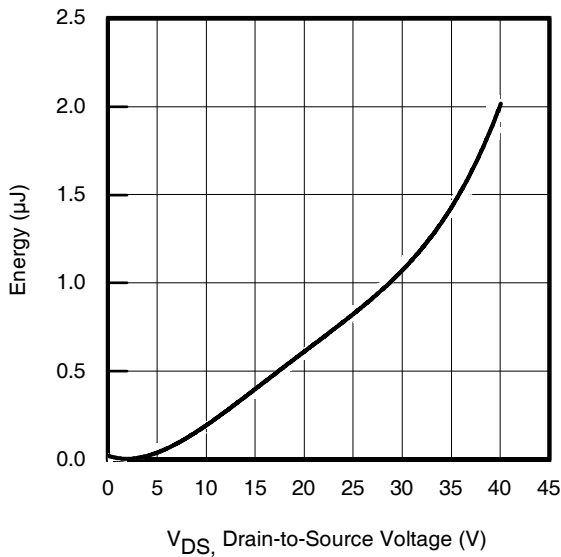

**Fig 11.** Typical  $C_{OSS}$  Stored Energy

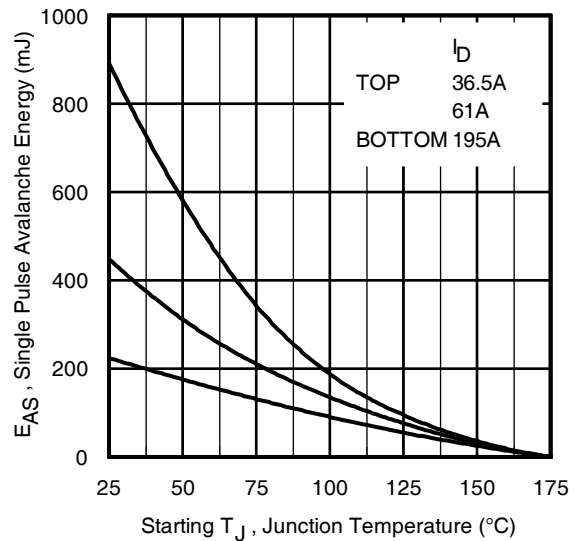

**Fig 12.** Maximum Avalanche Energy vs. Drain Current

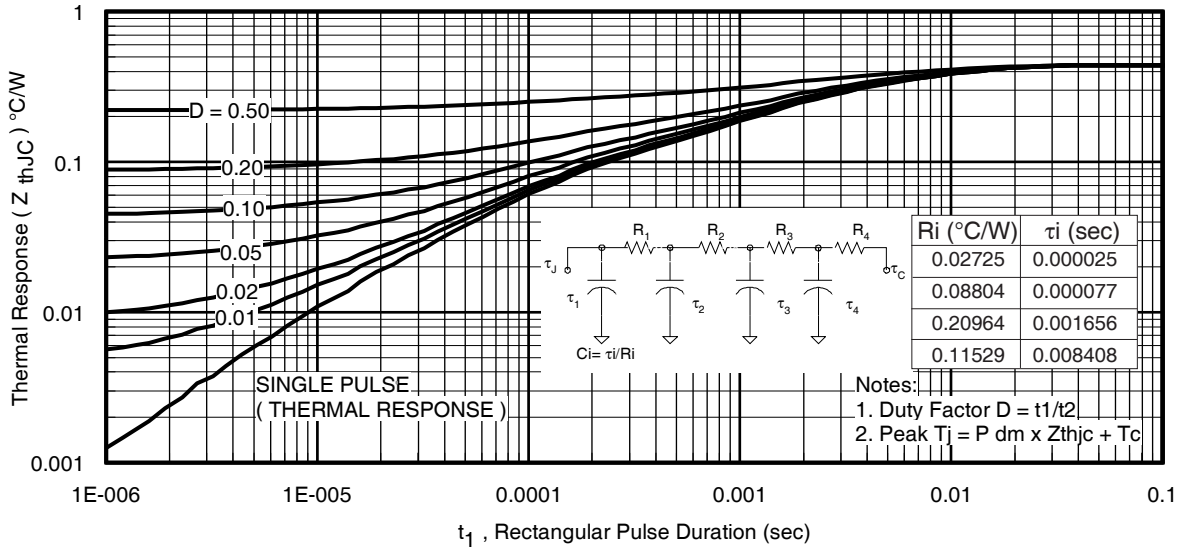

Fig 13. Maximum Effective Transient Thermal Impedance, Junction-to-Case

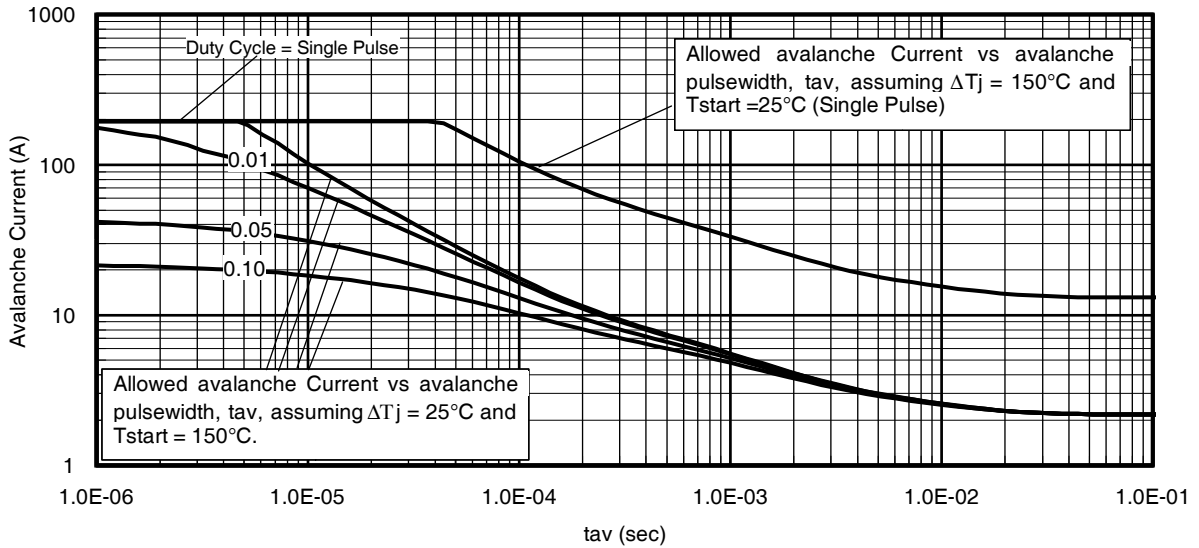
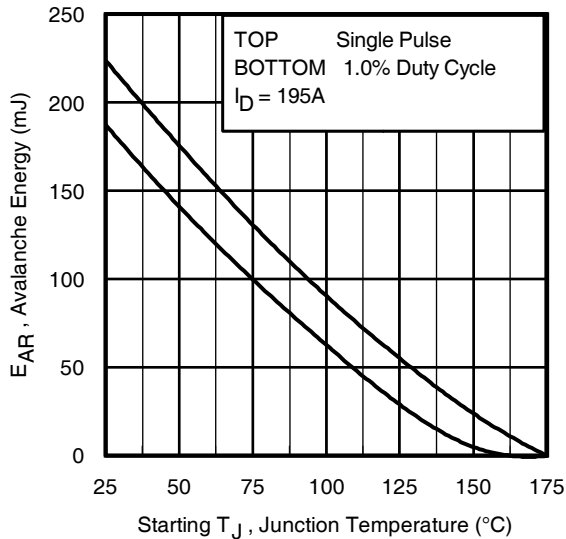

Fig 14. Typical Avalanche Current vs. Pulsewidth



**Notes on Repetitive Avalanche Curves , Figures 14, 15:**  
(For further info, see AN-1005 at [www.irf.com](http://www.irf.com))

1. Avalanche failures assumption:  
Purely a thermal phenomenon and failure occurs at a temperature far in excess of  $T_{jmax}$ . This is validated for every part type.
2. Safe operation in Avalanche is allowed as long as  $T_{jmax}$  is not exceeded.
3. Equation below based on circuit and waveforms shown in Figures 16a, 16b.
4.  $P_{D(ave)}$  = Average power dissipation per single avalanche pulse.
5.  $BV$  = Rated breakdown voltage (1.3 factor accounts for voltage increase during avalanche).
6.  $I_{av}$  = Allowable avalanche current.
7.  $\Delta T$  = Allowable rise in junction temperature, not to exceed  $T_{jmax}$  (assumed as 25°C in Figure 14, 15).  
 $t_{av}$  = Average time in avalanche.  
 $D$  = Duty cycle in avalanche =  $t_{av} \cdot f$   
 $Z_{thJC}(D, t_{av})$  = Transient thermal resistance, see Figures 13)

$$P_{D(ave)} = 1/2 ( 1.3 \cdot BV \cdot I_{av} ) = \Delta T / Z_{thJC}$$

$$I_{av} = 2\Delta T / [1.3 \cdot BV \cdot Z_{th}]$$

$$E_{AS(AR)} = P_{D(ave)} \cdot t_{av}$$

Fig 15. Maximum Avalanche Energy vs. Temperature

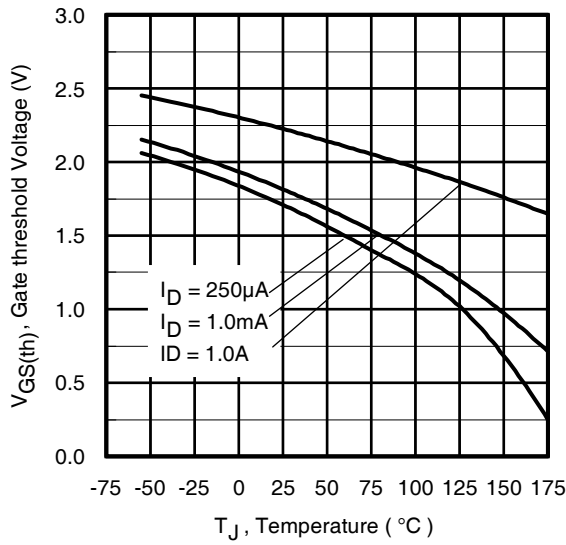

Fig 16. Threshold Voltage vs. Temperature

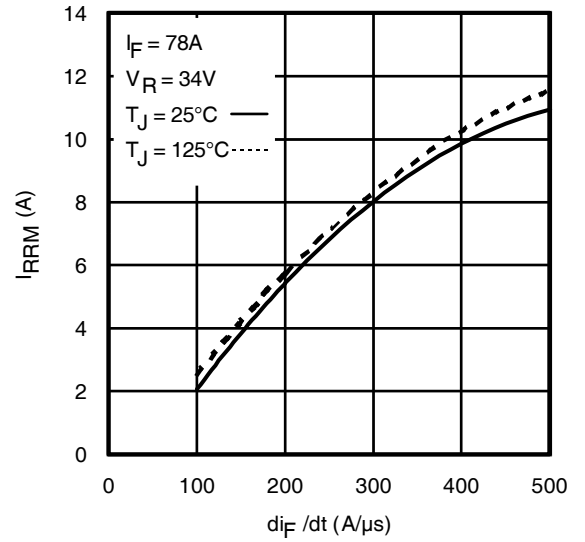

Fig. 17 - Typical Recovery Current vs.  $di_F/dt$

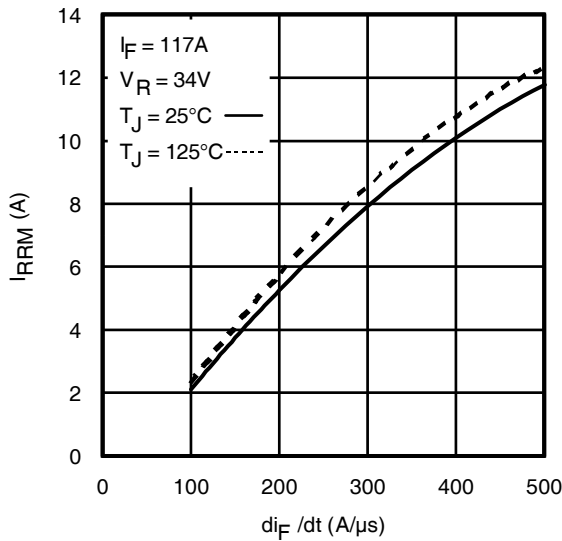

Fig. 18 - Typical Recovery Current vs.  $di_F/dt$

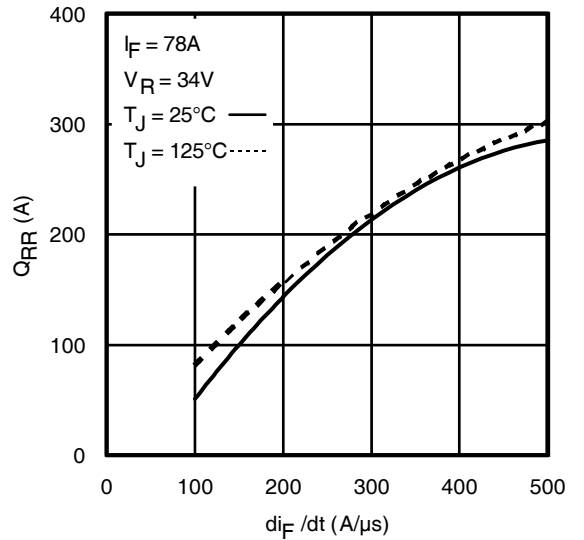

Fig. 19 - Typical Stored Charge vs.  $di_F/dt$

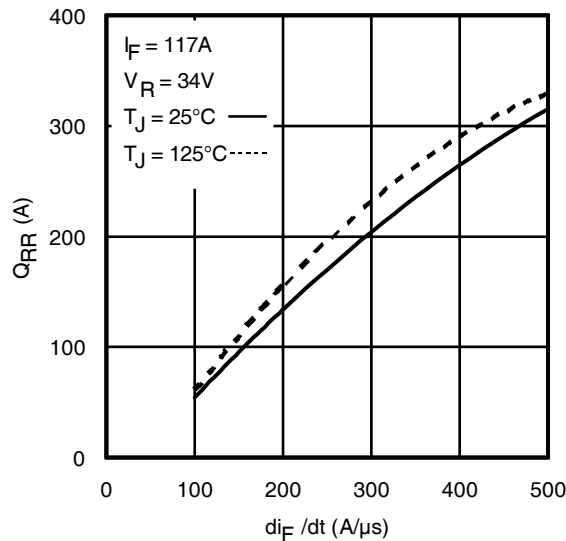

Fig. 20 - Typical Stored Charge vs.  $di_F/dt$



**Fig 21. Peak Diode Recovery dv/dt Test Circuit for N-Channel HEXFET® Power MOSFETs**



\*  $V_{GS} = 5V$  for Logic Level Devices

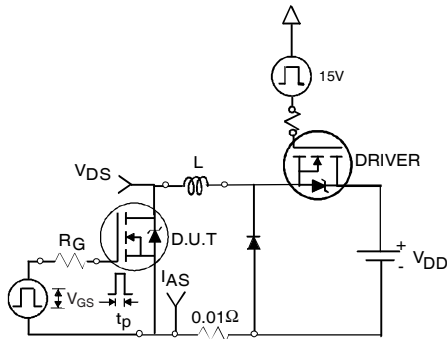

**Fig 22a. Unclamped Inductive Test Circuit**

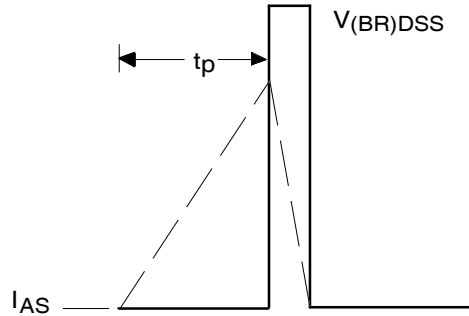

**Fig 22b. Unclamped Inductive Waveforms**

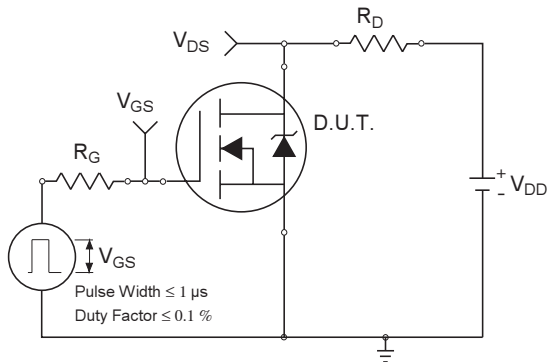

**Fig 23a. Switching Time Test Circuit**

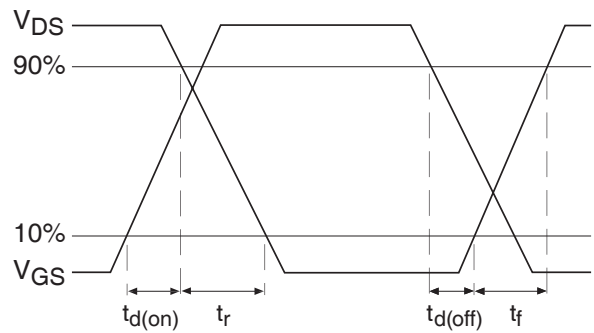

**Fig 23b. Switching Time Waveforms**



**Fig 24a. Gate Charge Test Circuit**

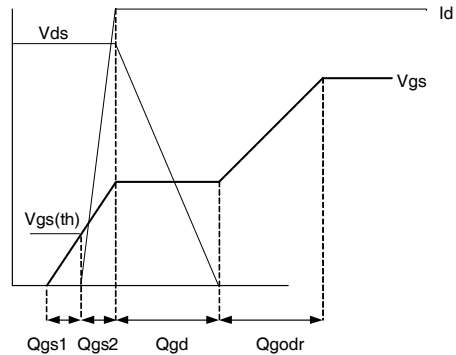

**Fig 24b. Gate Charge Waveform**

TO-247AC Package Outline

Dimensions are shown in millimeters (inches)

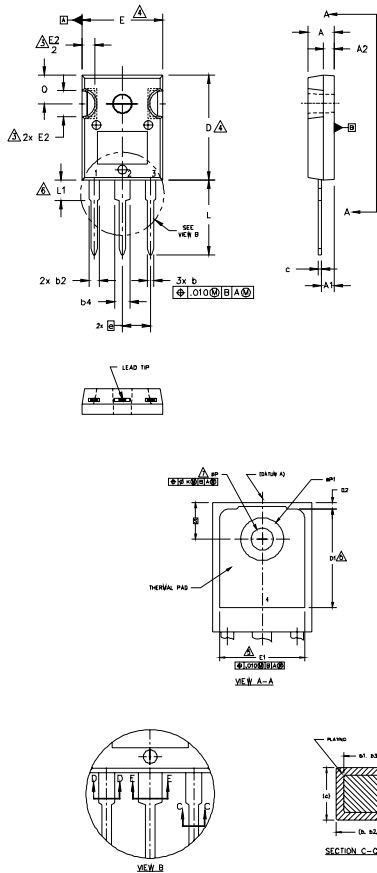

NOTES:

1. DIMENSIONING AND TOLERANCING AS PER ASME Y14.5M 1994.
2. DIMENSIONS ARE SHOWN IN INCHES.
3. CONTOUR OF SLOT OPTIONAL.
4. DIMENSION D & E DO NOT INCLUDE MOLD FLASH. MOLD FLASH SHALL NOT EXCEED .005" (0.127) PER SIDE. THESE DIMENSIONS ARE MEASURED AT THE OUTERMOST EXTREMES OF THE PLASTIC BODY.
5. THERMAL PAD CONTOUR OPTIONAL WITHIN DIMENSIONS D1 & E1.
6. LEAD FINISH UNCONTROLLED IN L1.
7.  $\phi P$  TO HAVE A MAXIMUM DRAFT ANGLE OF 1.5° TO THE TOP OF THE PART WITH A MAXIMUM HOLE DIAMETER OF .154 INCH.
8. OUTLINE CONFORMS TO JEDEC OUTLINE TO-247AC.

| SYMBOL    | DIMENSIONS |      |             |       | NOTES |
|-----------|------------|------|-------------|-------|-------|
|           | INCHES     |      | MILLIMETERS |       |       |
|           | MIN.       | MAX. | MIN.        | MAX.  |       |
| A         | .183       | .209 | 4.65        | 5.31  |       |
| A1        | .087       | .102 | 2.21        | 2.59  |       |
| A2        | .059       | .098 | 1.50        | 2.49  |       |
| b         | .039       | .055 | 0.99        | 1.40  |       |
| b1        | .039       | .053 | 0.99        | 1.35  |       |
| b2        | .065       | .094 | 1.65        | 2.39  |       |
| b3        | .065       | .092 | 1.65        | 2.34  |       |
| b4        | .102       | .135 | 2.59        | 3.43  |       |
| b5        | .102       | .133 | 2.59        | 3.38  |       |
| c         | .015       | .035 | 0.38        | 0.89  |       |
| c1        | .015       | .033 | 0.38        | 0.84  |       |
| D         | .776       | .815 | 19.71       | 20.70 | 4     |
| D1        | .515       | -    | 13.08       | -     | 5     |
| D2        | .020       | .053 | 0.51        | 1.35  |       |
| E         | .602       | .625 | 15.29       | 15.87 | 4     |
| E1        | .530       | -    | 13.46       | -     |       |
| E2        | .178       | .216 | 4.52        | 5.49  |       |
| e         | .215 BSC   |      | 5.46 BSC    |       |       |
| $\phi k$  | .010       |      | 0.25        |       |       |
| L         | .559       | .634 | 14.20       | 16.10 |       |
| L1        | .146       | .169 | 3.71        | 4.29  |       |
| $\phi P$  | .140       | .144 | 3.56        | 3.66  |       |
| $\phi P1$ | -          | .291 | -           | 7.39  |       |
| O         | .209       | .224 | 5.31        | 5.69  |       |
| S         | .217 BSC   |      | 5.51 BSC    |       |       |

LEAD ASSIGNMENTS

HEXFET

- 1.- GATE
- 2.- DRAIN
- 3.- SOURCE
- 4.- DRAIN

IGBTs, CoPACK

- 1.- GATE
- 2.- COLLECTOR
- 3.- EMITTER
- 4.- COLLECTOR

DIODES

- 1.- ANODE/OPEN
- 2.- CATHODE
- 3.- ANODE

TO-247AC Part Marking Information

EXAMPLE: THIS IS AN IRFPE30  
WITH ASSEMBLY  
LOT CODE 5657  
ASSEMBLED ON WW 35, 2001  
IN THE ASSEMBLY LINE "H"

Note: "P" in assembly line position  
indicates "Lead-Free"

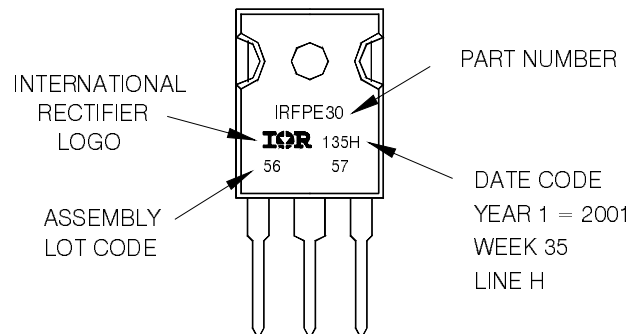

TO-247AC package is not recommended for Surface Mount Application.

Note: For the most current drawing please refer to IR website at <http://www.irf.com/package/>

Data and specifications subject to change without notice.  
This product has been designed and qualified for the Industrial market.  
Qualification Standards can be found on IR's Web site.



## **IMPORTANT NOTICE**

The information given in this document shall in no event be regarded as a guarantee of conditions or characteristics ("Beschaffheitsgarantie").

With respect to any examples, hints or any typical values stated herein and/or any information regarding the application of the product, Infineon Technologies hereby disclaims any and all warranties and liabilities of any kind, including without limitation warranties of non-infringement of intellectual property rights of any third party.

In addition, any information given in this document is subject to customer's compliance with its obligations stated in this document and any applicable legal requirements, norms and standards concerning customer's products and any use of the product of Infineon Technologies in customer's applications.

The data contained in this document is exclusively intended for technically trained staff. It is the responsibility of customer's technical departments to evaluate the suitability of the product for the intended application and the completeness of the product information given in this document with respect to such application.

For further information on the product, technology, delivery terms and conditions and prices please contact your nearest Infineon Technologies office ([www.infineon.com](http://www.infineon.com)).

## **WARNINGS**

Due to technical requirements products may contain dangerous substances. For information on the types in question please contact your nearest Infineon Technologies office.

Except as otherwise explicitly approved by Infineon Technologies in a written document signed by authorized representatives of Infineon Technologies, Infineon Technologies' products may not be used in any applications where a failure of the product or any consequences of the use thereof can reasonably be expected to result in personal injury.

## X-ON Electronics

Largest Supplier of Electrical and Electronic Components

*Click to view similar products for [MOSFET](#) category:*

*Click to view products by [Infineon](#) manufacturer:*

Other Similar products are found below :

[614233C](#) [648584F](#) [IRFD120](#) [JANTX2N5237](#) [FCA20N60\\_F109](#) [FDZ595PZ](#) [2SK2545\(Q,T\)](#) [405094E](#) [423220D](#) [TPCC8103,L1Q\(CM](#)  
[MIC4420CM-TR](#) [VN1206L](#) [614234A](#) [715780A](#) [NTNS3166NZT5G](#) [SSM6J414TU,LF\(T](#) [751625C](#) [BUK954R8-60E](#) [GROUP A 5962-](#)  
[8877003PA](#) [NTE6400](#) [SQJ402EP-T1-GE3](#) [2SK2614\(TE16L1,Q\)](#) [2N7002KW-FAI](#) [DMN1017UCP3-7](#) [EFC2J004NUZTDG](#) [ECH8691-TL-W](#)  
[FCAB21350L1](#) [P85W28HP2F-7071](#) [DMN1053UCP4-7](#) [NTE221](#) [NTE222](#) [NTE2384](#) [NTE2903](#) [NTE2941](#) [NTE2945](#) [NTE2946](#) [NTE2960](#)  
[NTE2967](#) [NTE2969](#) [NTE2976](#) [NTE6400A](#) [NTE2910](#) [NTE2916](#) [NTE2956](#) [NTE2911](#) [DMN2080UCB4-7](#) [TK10A80W,S4X\(S](#)  
[SSM6P54TU,LF](#) [SSM6P69NU,LF](#) [DMP22D4UFO-7B](#)