

IRLR3802PbF
IRLU3802PbF

HEXFET® Power MOSFET

Applications

- High Frequency 3.3V and 5V input Point-of-Load Synchronous Buck Converters
- Power Management for Netcom, Computing and Portable Applications.
- Lead-Free

V_{DSS}	$R_{DS(on)}$ max	Q_g
12V	8.5m Ω	27nC

Benefits

- Ultra-Low Gate Impedance
- Very Low $R_{DS(on)}$
- Fully Characterized Avalanche Voltage and Current

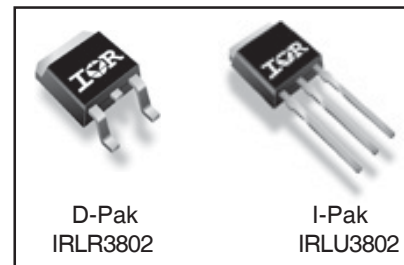

Absolute Maximum Ratings

Symbol	Parameter	Max.	Units
V_{DS}	Drain-Source Voltage	12	V
V_{GS}	Gate-to-Source Voltage	± 12	V
$I_D @ T_C = 25^\circ\text{C}$	Continuous Drain Current, $V_{GS} @ 4.5\text{V}$	84 ④	A
$I_D @ T_C = 100^\circ\text{C}$	Continuous Drain Current, $V_{GS} @ 4.5\text{V}$	60 ④	
I_{DM}	Pulsed Drain Current ①	320	
$P_D @ T_C = 25^\circ\text{C}$	Maximum Power Dissipation	88	W
$P_D @ T_C = 100^\circ\text{C}$	Maximum Power Dissipation	44	W
	Linear Derating Factor	0.59	mW/ $^\circ\text{C}$
T_J, T_{STG}	Junction and Storage Temperature Range	-55 to + 175	$^\circ\text{C}$

Thermal Resistance

	Parameter	Typ.	Max.	Units
$R_{\theta JC}$	Junction-to-Case	—	1.7	$^\circ\text{C}/\text{W}$
$R_{\theta JA}$	Junction-to-Ambient (PCB mount)*	—	40	
$R_{\theta JA}$	Junction-to-Ambient	—	110	

Notes ① through ④ are on page 9
www.irf.com

Static @ T_J = 25°C (unless otherwise specified)

	Parameter	Min.	Typ.	Max.	Units	Conditions
BV _{DSS}	Drain-to-Source Breakdown Voltage	12	—	—	V	V _{GS} = 0V, I _D = 250μA
ΔBV _{DSS} /ΔT _J	Breakdown Voltage Temp. Coefficient	—	0.009	—	V/°C	Reference to 25°C, I _D = 1mA ③
R _{DS(on)}	Static Drain-to-Source On-Resistance	—	6.5	8.5	mΩ	V _{GS} = 4.5V, I _D = 15A ③
		—	—	30		V _{GS} = 2.8V, I _D = 12A
V _{GS(th)}	Gate Threshold Voltage	0.6	—	1.9	V	V _{DS} = V _{GS} , I _D = 250μA
ΔV _{GS(th)} /ΔT _J	Gate Threshold Voltage Coefficient	—	-3.2	—	mV/°C	
I _{DSS}	Drain-to-Source Leakage Current	—	—	100	μA	V _{DS} = 9.6V, V _{GS} = 0V
		—	—	250		V _{DS} = 9.6V, V _{GS} = 0V, T _J = 125°C
I _{GSS}	Gate-to-Source Forward Leakage	—	—	200	nA	V _{GS} = 12V
	Gate-to-Source Reverse Leakage	—	—	-200		V _{GS} = -12V
g _{fs}	Forward Transconductance	31	—	—	S	V _{DS} = 6.0V, I _D = 12A
Q _g	Total Gate Charge	—	27	41	nC	V _{DS} = 6.0V V _{GS} = 5.0V I _D = 6.0A See Fig.16
Q _{gs1}	Pre-V _{th} Gate-Source Charge	—	3.6	—		
Q _{gs2}	Post-V _{th} Gate-Source Charge	—	2.0	—		
Q _{gd}	Gate-to-Drain Charge	—	10	—		
Q _{godr}	Gate Charge Overdrive	—	11	—		
Q _{sw}	Switch Charge (Q _{gs2} + Q _{gd})	—	12	—		
Q _{oss}	Output Charge	—	28	—	nC	V _{DS} = 10V, V _{GS} = 0V
t _{d(on)}	Turn-On Delay Time	—	11	—	ns	V _{DD} = 6.0V, V _{GS} = 4.5V③ I _D = 12A Clamped Inductive Load
t _r	Rise Time	—	14	—		
t _{d(off)}	Turn-Off Delay Time	—	21	—		
t _f	Fall Time	—	17	—		
C _{iss}	Input Capacitance	—	2490	—	pF	V _{GS} = 0V V _{DS} = 6.0V f = 1.0MHz
C _{oss}	Output Capacitance	—	2150	—		
C _{rss}	Reverse Transfer Capacitance	—	530	—		

Avalanche Characteristics

Symbol	Parameter	Typ.	Max.	Units
E _{AS}	Single Pulse Avalanche Energy②	—	300	mJ
I _{AR}	Avalanche Current①	—	20	A

Diode Characteristics

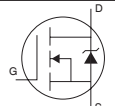
Symbol	Parameter	Min.	Typ.	Max.	Units	Conditions
I _S	Continuous Source Current (Body Diode)	—	—	84④	A	MOSFET symbol showing the integral reverse p-n junction diode. 
I _{SM}	Pulsed Source Current (Body Diode) ①	—	—	320		
V _{SD}	Diode Forward Voltage	—	0.81	1.2	V	T _J = 25°C, I _S = 12A, V _{GS} = 0V ③
		—	0.65	—		T _J = 125°C, I _S = 12A, V _{GS} = 0V ③
t _{rr}	Reverse Recovery Time	—	52	78	ns	T _J = 25°C, I _F = 12A, V _R = 20V
Q _{rr}	Reverse Recovery Charge	—	54	81	nC	di/dt = 100A/μs ③
t _{rr}	Reverse Recovery Time	—	50	75	ns	T _J = 125°C, I _F = 12A, V _R = 20V
Q _{rr}	Reverse Recovery Charge	—	50	75	nC	di/dt = 100A/μs ③

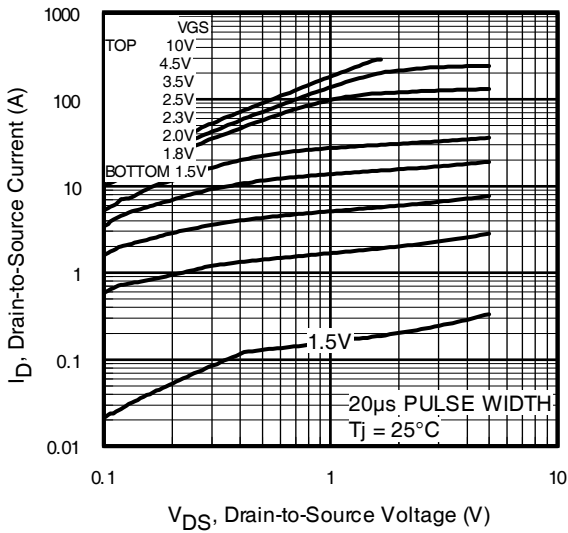

Fig 1. Typical Output Characteristics

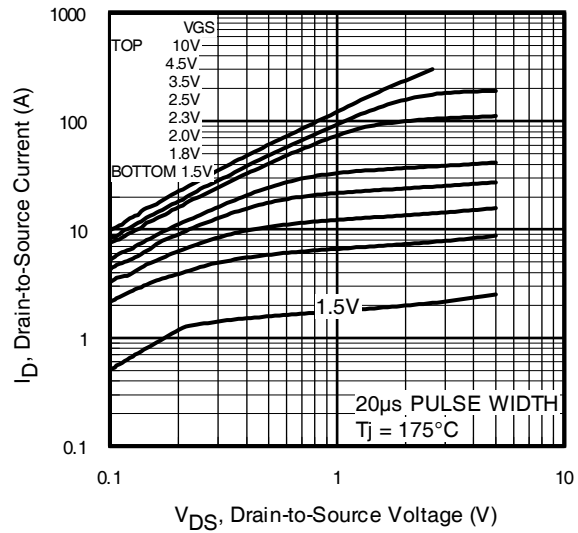

Fig 2. Typical Output Characteristics

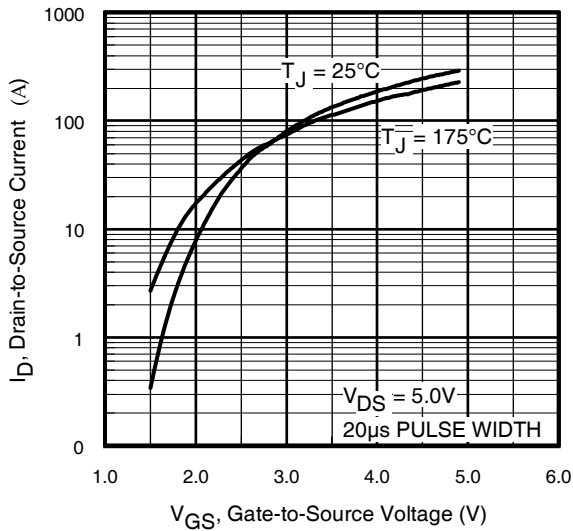

Fig 3. Typical Transfer Characteristics

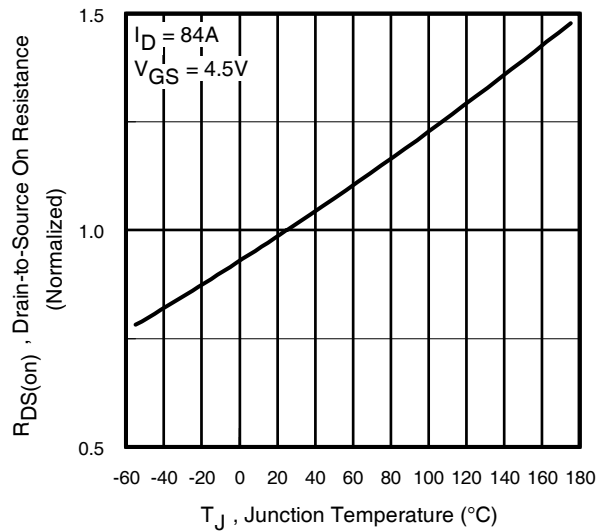

Fig 4. Normalized On-Resistance Vs. Temperature

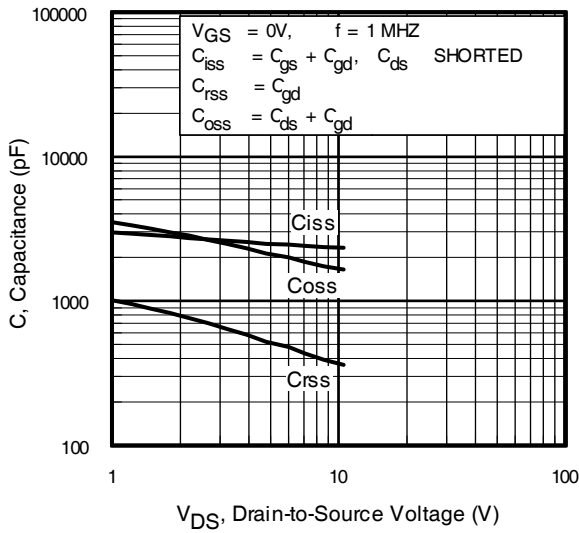

Fig 5. Typical Capacitance Vs. Drain-to-Source Voltage

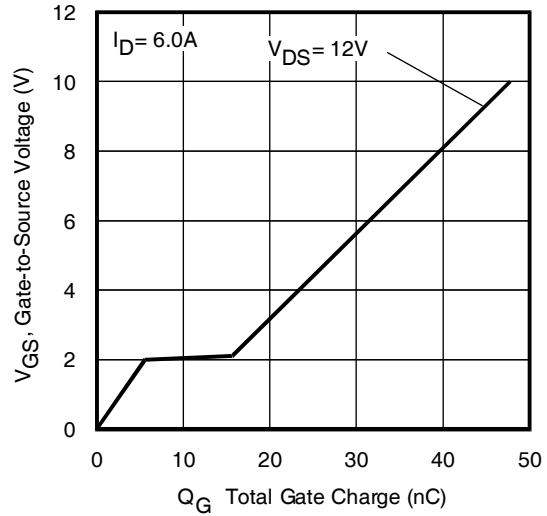

Fig 6. Typical Gate Charge Vs. Gate-to-Source Voltage

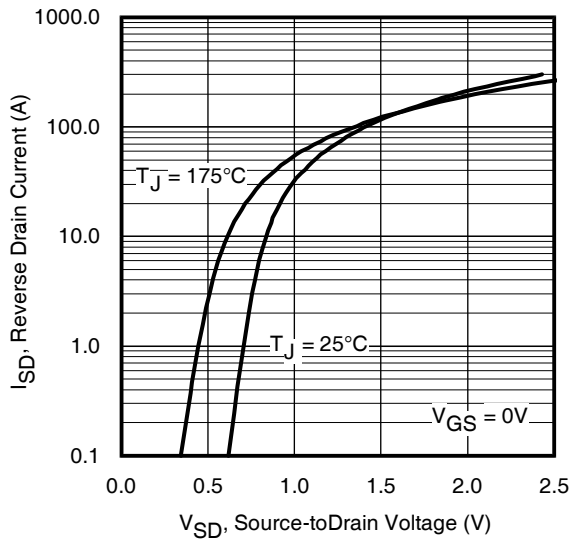

Fig 7. Typical Source-Drain Diode Forward Voltage

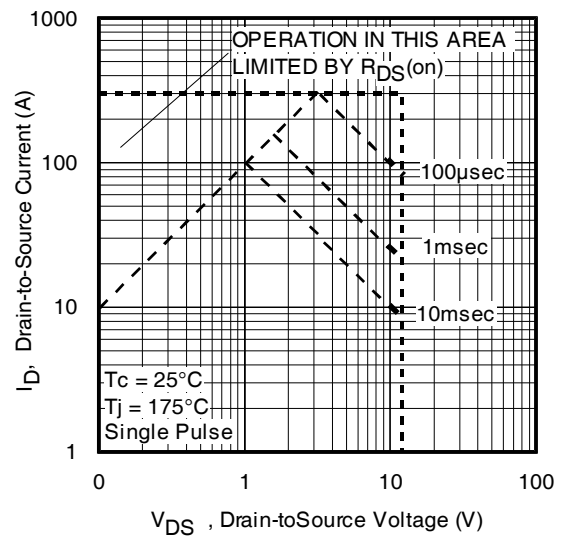

Fig 8. Maximum Safe Operating Area

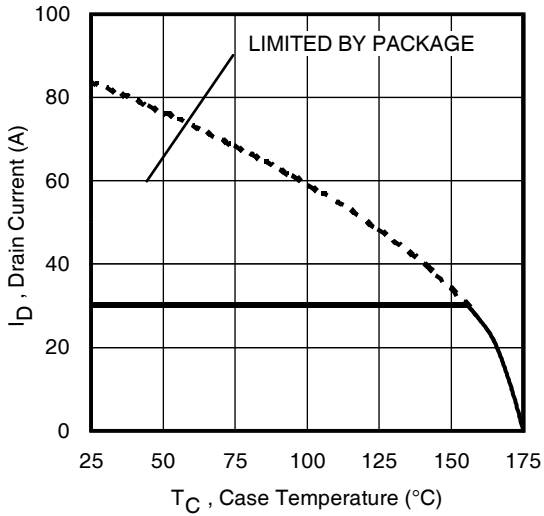

Fig 9. Maximum Drain Current Vs. Case Temperature

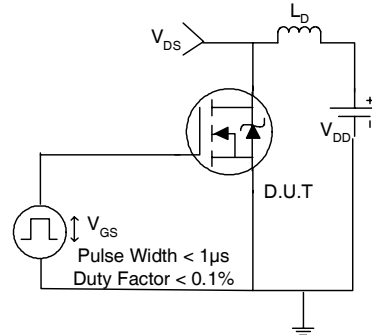

Fig 10a. Switching Time Test Circuit

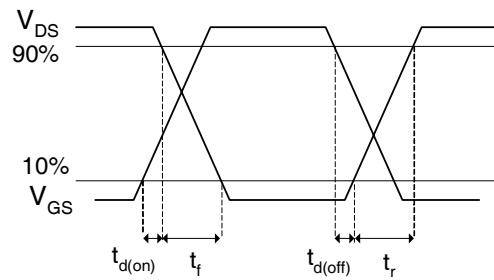

Fig 10b. Switching Time Waveforms

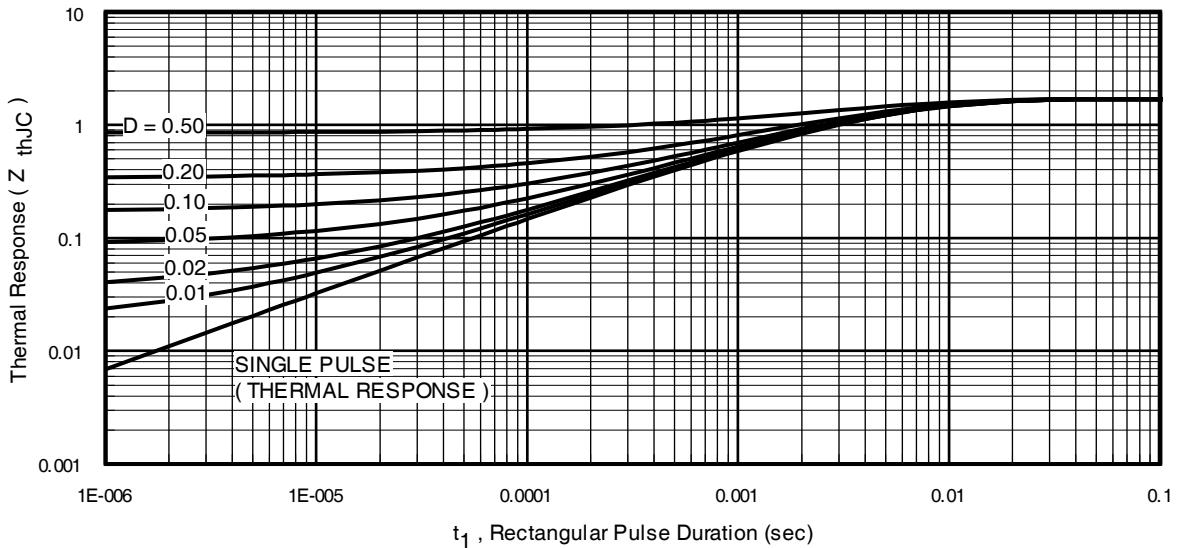

Fig 11. Maximum Effective Transient Thermal Impedance, Junction-to-Case

IRLR/U3802PbF

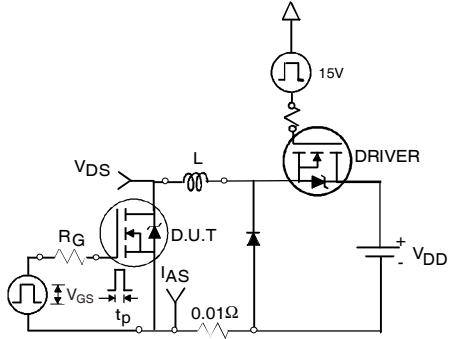

Fig 12a. Unclamped Inductive Test Circuit

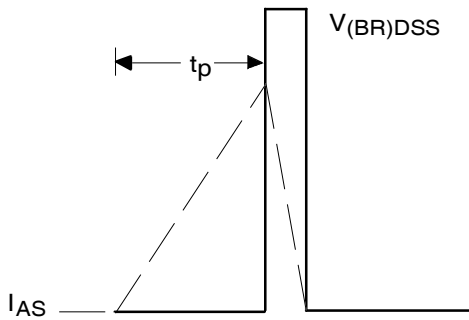

Fig 12b. Unclamped Inductive Waveforms

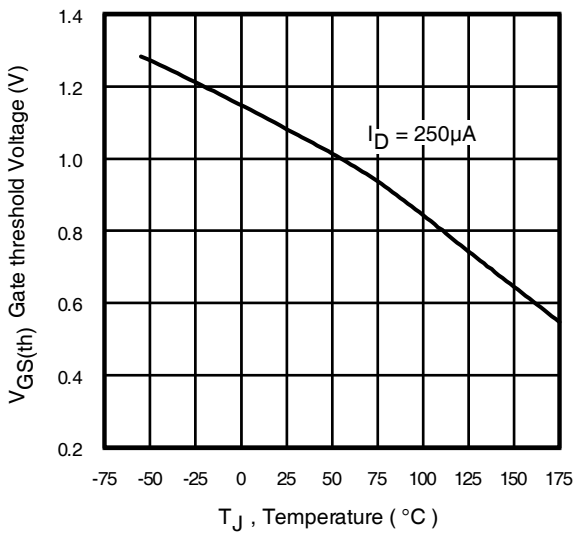

Fig 13. Threshold Voltage Vs. Temperature

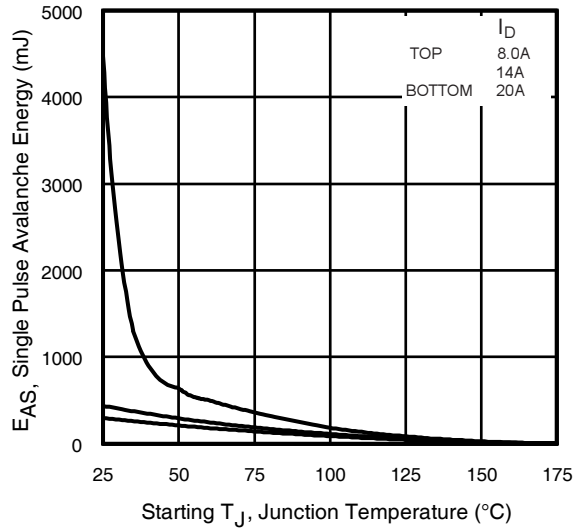

Fig 12c. Maximum Avalanche Energy Vs. Drain Current

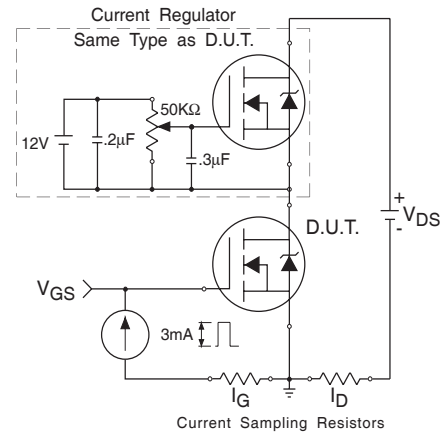

Fig 14. Gate Charge Test Circuit

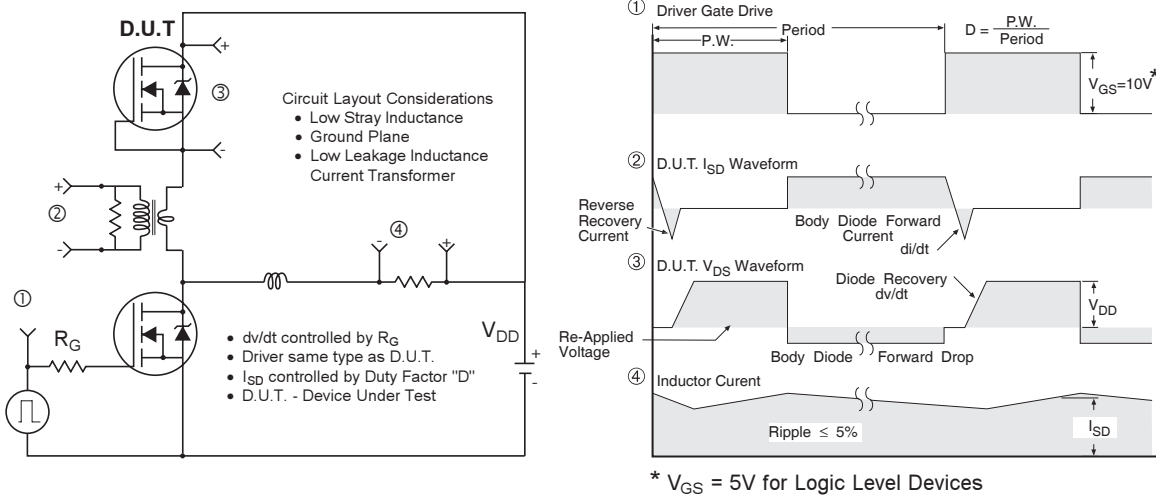

Fig 15. Peak Diode Recovery dv/dt Test Circuit for N-Channel HEXFET® Power MOSFETs

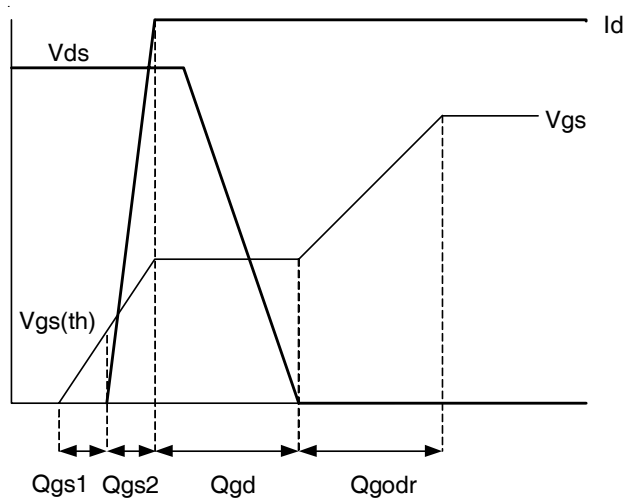

Fig 16. Gate Charge Waveform

IRLR/U3802PbF

International
IR Rectifier

D-Pak (TO-252AA) Package Outline

Dimensions are shown in millimeters (inches)

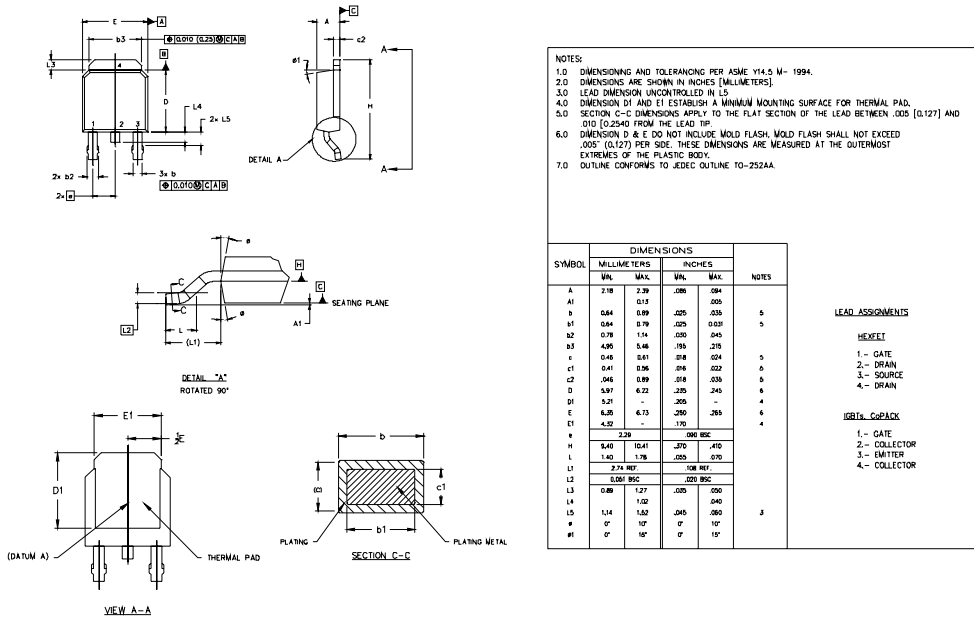

D-Pak (TO-252AA) Part Marking Information

EXAMPLE: THIS IS AN IRFR120
WITH ASSEMBLY
LOT CODE 1234
ASSEMBLED ON WW 16, 1999
IN THE ASSEMBLY LINE "A"

Note: "P" in assembly line position
indicates "Lead-Free"

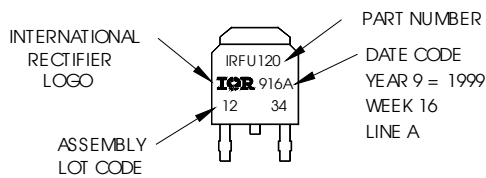

OR

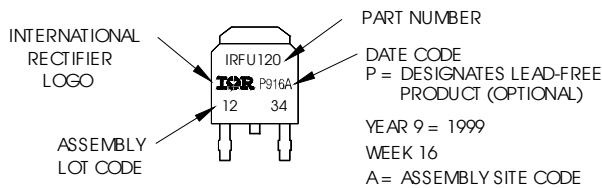

I-Pak (TO-251AA) Package Outline

Dimensions are shown in millimeters (inches)

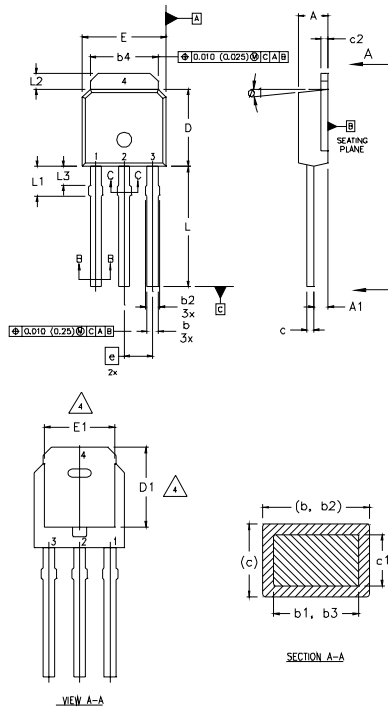

- NOTES:
- 1 DIMENSIONING AND TOLERANCING PER ASME Y14.5 M- 1994.
 - 2 DIMENSIONS ARE SHOWN IN MILLIMETERS [INCHES].
 - 3 DIMENSION D & E DO NOT INCLUDE MOLD FLASH. MOLD FLASH SHALL NOT EXCEED 0.005" (0.127) PER SIDE. THESE DIMENSIONS ARE MEASURED AT THE OUTERMOST EXTREMES OF THE PLASTIC BODY.
 - 4 THERMAL PAD CONTOUR OPTION WITHIN DIMENSION b4, L2, E1 & D1.
 - 5 LEAD DIMENSION UNCONTROLLED IN L3.
 - 6 DIMENSION b1, b3 APPLY TO BASE METAL ONLY.
 - 7 OUTLINE CONFORMS TO JEDEC OUTLINE TO-251AA.
 - 8 CONTROLLING DIMENSION : INCHES.

LEAD ASSIGNMENTS

- HEXFET
- 1.- GATE
 - 2.- DRAIN
 - 3.- SOURCE
 - 4.- DRAIN

SYMBOL	DIMENSIONS				NOTES
	MILLIMETERS		INCHES		
	MIN.	MAX.	MIN.	MAX.	
A	2.18	2.39	0.086	.094	
A1	0.89	1.14	0.035	0.045	
b	0.64	0.89	0.025	0.035	
b1	0.64	0.79	0.025	0.031	4
b2	0.76	1.14	0.030	0.045	
b3	0.76	1.04	0.030	0.041	
b4	5.00	5.46	0.195	0.215	4
c	0.46	0.61	0.018	0.024	
c1	0.41	0.56	0.016	0.022	
c2	.046	0.86	0.018	0.035	
D	5.97	6.22	0.235	0.245	3, 4
D1	5.21	-	0.205	-	4
E	6.35	6.73	0.250	0.265	3, 4
E1	4.32	-	0.170	-	4
e	2.29		0.090 BSC		
L	8.89	9.60	0.350	0.380	
L1	1.91	2.29	0.075	0.090	
L2	0.89	1.27	0.035	0.050	4
L3	1.14	1.52	0.045	0.060	5
ø1	Ø	15'	Ø	15'	

I-Pak (TO-251AA) Part Marking Information

EXAMPLE: THIS IS AN IRFU120
WITH ASSEMBLY
LOT CODE 5678
ASSEMBLED ON VW 19, 1999
IN THE ASSEMBLY LINE "A"

Note: "P" in assembly line
position indicates "Lead-Free"

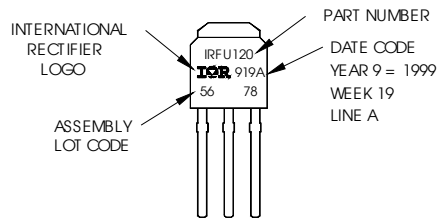

OR

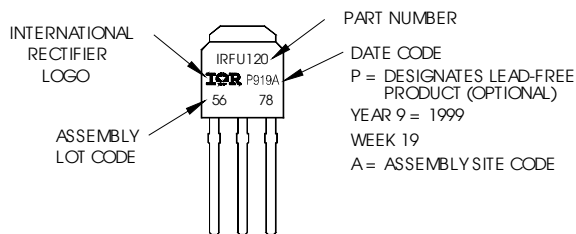

IRLR/U3802PbF

D-Pak (TO-252AA) Tape & Reel Information

International
IR Rectifier

Dimensions are shown in millimeters (inches)

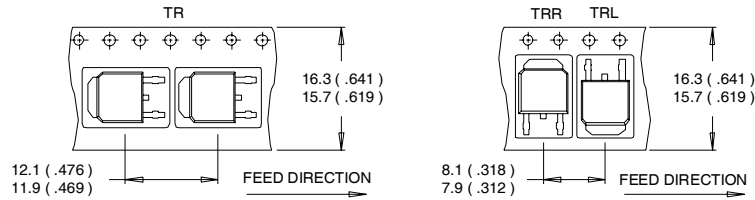

- NOTES :
1. CONTROLLING DIMENSION : MILLIMETER.
 2. ALL DIMENSIONS ARE SHOWN IN MILLIMETERS (INCHES).
 3. OUTLINE CONFORMS TO EIA-481 & EIA-541.

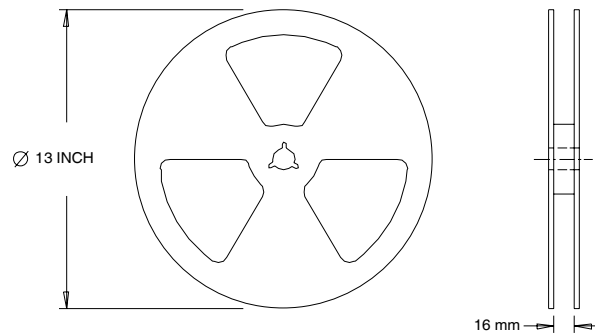

- NOTES :
1. OUTLINE CONFORMS TO EIA-481.

Notes:

- ① Repetitive rating; pulse width limited by max. junction temperature.
 - ② Starting $T_J = 25^\circ\text{C}$, $L = 1.4\text{mH}$
 $R_G = 25\Omega$, $I_{AS} = 20\text{A}$.
 - ③ Pulse width $\leq 400\mu\text{s}$; duty cycle $\leq 2\%$.
 - ④ Calculated continuous current based on maximum allowable junction temperature. Package limitation current is 30A.
- * When mounted on 1" square PCB (FR-4 or G-10 Material).
For recommended footprint and soldering techniques refer to application note #AN-994.

Data and specifications subject to change without notice.
This product has been designed and qualified for the Industrialmarket.
Qualification Standards can be found on IR's Web site.

International
IR Rectifier

IR WORLD HEADQUARTERS: 233 Kansas St., El Segundo, California 90245, USA Tel: (310) 252-7105
TAC Fax: (310) 252-7903

Visit us at www.irf.com for sales contact information.12/04

www.irf.com

Note: For the most current drawings please refer to the IR website at:
<http://www.irf.com/package/>

X-ON Electronics

Largest Supplier of Electrical and Electronic Components

Click to view similar products for [MOSFET](#) category:

Click to view products by [Infineon](#) manufacturer:

Other Similar products are found below :

[614233C](#) [648584F](#) [MCH3443-TL-E](#) [MCH6422-TL-E](#) [FW231A-TL-E](#) [APT5010JVR](#) [NTNS3A92PZT5G](#) [IRF100S201](#) [JANTX2N5237](#)
[2SK2464-TL-E](#) [2SK3818-DL-E](#) [FCA20N60_F109](#) [FDZ595PZ](#) [STD6600NT4G](#) [FSS804-TL-E](#) [2SJ277-DL-E](#) [2SK1691-DL-E](#) [2SK2545\(Q,T\)](#)
[D2294UK](#) [405094E](#) [423220D](#) [MCH6646-TL-E](#) [TPCC8103,L1Q\(CM](#) [367-8430-0972-503](#) [VN1206L](#) [424134F](#) [026935X](#) [051075F](#)
[SBVS138LT1G](#) [614234A](#) [715780A](#) [NTNS3166NZT5G](#) [751625C](#) [873612G](#) [IRF7380TRHR](#) [IPS70R2K0CEAKMA1](#) [RJK60S3DPP-E0#T2](#)
[RJK60S5DPK-M0#T0](#) [APT5010JVFR](#) [APT12031JFLL](#) [APT12040JVR](#) [DMN3404LQ-7](#) [NTE6400](#) [JANTX2N6796U](#) [JANTX2N6784U](#)
[JANTXV2N5416U4](#) [SQM110N05-06L-GE3](#) [SIHF35N60E-GE3](#) [2SK2614\(TE16L1,Q\)](#) [2N7002KW-FAI](#)