

IRS2103(S)PbF

HALF-BRIDGE DRIVER

Features

- Floating channel designed for bootstrap operation
- Fully operational to +600 V
- Tolerant to negative transient voltage, dV/dt immune
- Gate drive supply range from 10 V to 20 V
- Undervoltage lockout
- 3.3 V, 5 V, and 15 V logic compatible
- Cross-conduction prevention logic
- Matched propagation delay for both channels
- Internal set deadtime
- High-side output in phase with HIN input
- Low-side output out of phase with LIN input
- RoHS compliant

Description

The IRS2103 is a high voltage, high speed power MOSFET and IGBT drivers with dependent high- and low-side referenced output channels. Proprietary HVIC and latch immune CMOS technologies enable ruggedized monolithic construction. The logic input is compatible with standard CMOS or LSTTL output, down to 3.3 V logic. The output drivers feature a high pulse current buffer stage designed for minimum driver cross-conduction. The floating channel can be used to drive an N-channel power MOSFET or IGBT in the high-side configuration which operates up to 600 V.

Product Summary

| | |
|----------------------------|---------------|
| V_{OFFSET} | 600 V max. |
| $I_{\text{O+/-}}$ | 130 mA/270 mA |
| V_{OUT} | 10 V - 20 V |
| $t_{\text{on/off (typ.)}}$ | 680 ns/150 ns |
| Deadtime (typ.) | 520 ns |

Packages



8-Lead PDIP
IRS2103



8-Lead SOIC
IRS2103S

Typical Connection

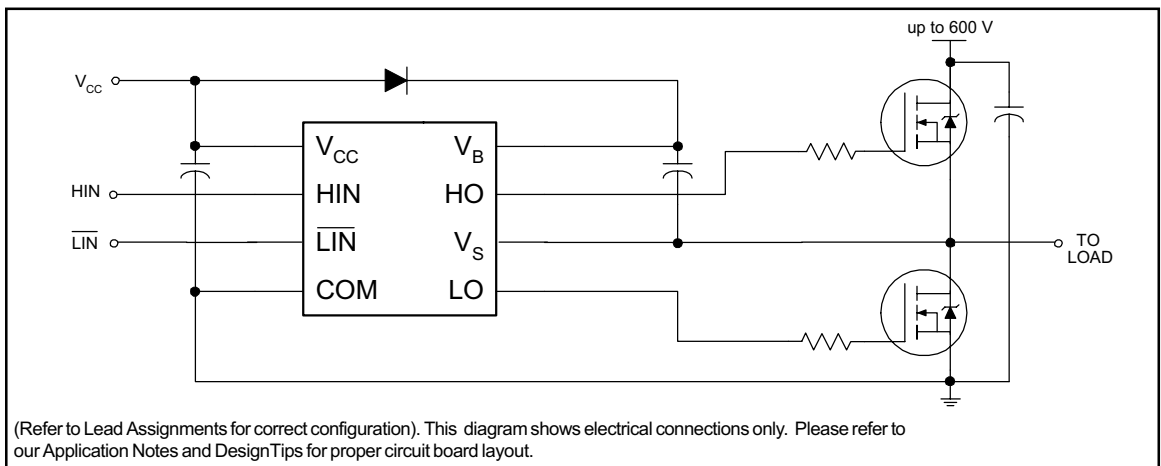

Absolute Maximum Ratings

Absolute maximum ratings indicate sustained limits beyond which damage to the device may occur. All voltage parameters are absolute voltages referenced to COM. The thermal resistance and power dissipation ratings are measured under board mounted and still air conditions.

| Symbol | Definition | Min. | Max. | Units | |
|---------------------|---|----------------------|-----------------------|-------|------|
| V _B | High-side floating absolute voltage | -0.3 | 625 | V | |
| V _S | High-side floating supply offset voltage | V _B - 25 | V _B + 0.3 | | |
| V _{HO} | High-side floating output voltage | V _S - 0.3 | V _B + 0.3 | | |
| V _{CC} | Low-side and logic fixed supply voltage | -0.3 | 25 | | |
| V _{LO} | Low-side output voltage | -0.3 | V _{CC} + 0.3 | | |
| V _{IN} | Logic input voltage (HIN & LIN) | -0.3 | V _{CC} + 0.3 | | |
| dV _S /dt | Allowable offset supply voltage transient | — | 50 | V/ns | |
| P _D | Package power dissipation @ T _A ≤ +25 °C | (8 Lead PDIP) | — | 1.0 | W |
| | | (8 Lead SOIC) | — | 0.625 | |
| R _{thJA} | Thermal resistance, junction to ambient | (8 Lead PDIP) | — | 125 | °C/W |
| | | (8 Lead SOIC) | — | 200 | |
| T _J | Junction temperature | — | 150 | °C | |
| T _S | Storage temperature | -55 | 150 | | |
| T _L | Lead temperature (soldering, 10 seconds) | — | 300 | | |

Recommended Operating Conditions

The input/output logic timing diagram is shown in Fig. 1. For proper operation the device should be used within the recommended conditions. The V_S offset rating is tested with all supplies biased at a 15 V differential.

| Symbol | Definition | Min. | Max. | Units |
|-----------------|--|---------------------|---------------------|-------|
| V _B | High-side floating supply absolute voltage | V _S + 10 | V _S + 20 | V |
| V _S | High-side floating supply offset voltage | Note 1 | 600 | |
| V _{HO} | High-side floating output voltage | V _S | V _B | |
| V _{CC} | Low-side and logic fixed supply voltage | 10 | 20 | |
| V _{LO} | Low-side output voltage | 0 | V _{CC} | |
| V _{IN} | Logic input voltage (HIN & LIN) | 0 | V _{CC} | |
| T _A | Ambient temperature | -40 | 125 | °C |

Note 1: Logic operational for V_S of -5 V to +600 V. Logic state held for V_S of -5 V to -V_{BS}. (Please refer to the Design Tip DT97-3 for more details).

Dynamic Electrical Characteristics

V_{BIAS} (V_{CC} , V_{BS}) = 15 V, C_L = 1000 pF and T_A = 25 °C unless otherwise specified.

| Symbol | Definition | Min. | Typ. | Max. | Units | Test Conditions |
|-----------|---|------|------|------|-------|-----------------|
| t_{on} | Turn-on propagation delay | — | 680 | 820 | ns | $V_S = 0$ V |
| t_{off} | Turn-off propagation delay | — | 150 | 220 | | $V_S = 600$ V |
| t_r | Turn-on rise time | — | 70 | 170 | | |
| t_f | Turn-off fall time | — | 35 | 90 | | |
| DT | Deadtime, LS turn-off to HS turn-on & HS turn-on to LS turn-off | 400 | 520 | 650 | | |
| MT | Delay matching, HS & LS turn-on/off | — | — | 60 | | |

Static Electrical Characteristics

V_{BIAS} (V_{CC} , V_{BS}) = 15 V and T_A = 25 °C unless otherwise specified. The V_{IN} , V_{TH} , and I_{IN} parameters are referenced to COM. The V_O and I_O parameters are referenced to COM and are applicable to the respective output leads: HO or LO.

| Symbol | Definition | Min. | Typ. | Max. | Units | Test Conditions |
|-------------|--|------|------|------|---------|---|
| V_{IH} | Logic "1" (HIN) & Logic "0" (\overline{LIN}) input voltage | 2.5 | — | — | V | $V_{CC} = 10$ V to 20 V |
| V_{IL} | Logic "0" (HIN) & Logic "1" (\overline{LIN}) input voltage | — | — | 0.8 | | |
| V_{OH} | High level output voltage, $V_{BIAS} - V_O$ | — | 0.05 | 0.2 | | $I_O = 2$ mA |
| V_{OL} | Low level output voltage, V_O | — | 0.02 | 0.1 | | |
| I_{LK} | Offset supply leakage current | — | — | 50 | μ A | $V_B = V_S = 600$ V |
| I_{QBS} | Quiescent V_{BS} supply current | — | 30 | 55 | | $V_{IN} = 0$ V or 5 V |
| I_{QCC} | Quiescent V_{CC} supply current | — | 150 | 270 | | $HIN = 5$ V, $\overline{LIN} = 0$ V |
| I_{IN+} | Logic "1" input bias current | — | 3 | 10 | | $HIN = 0$ V, $\overline{LIN} = 5$ V |
| I_{IN-} | Logic "0" input bias current | — | — | 5 | | |
| V_{CCUV+} | V_{CC} supply undervoltage positive going threshold | 8 | 8.9 | 9.8 | V | |
| V_{CCUV-} | V_{CC} supply undervoltage negative going threshold | 7.4 | 8.2 | 9 | | |
| I_{O+} | Output high short circuit pulsed current | 130 | 290 | — | mA | $V_O = 0$ V, $V_{IN} = V_{IH}$ $PW \leq 10$ μ s |
| I_{O-} | Output low short circuit pulsed current | 270 | 600 | — | | $V_O = 15$ V, $V_{IN} = V_{IL}$ $PW \leq 10$ μ s |

Functional Block Diagram

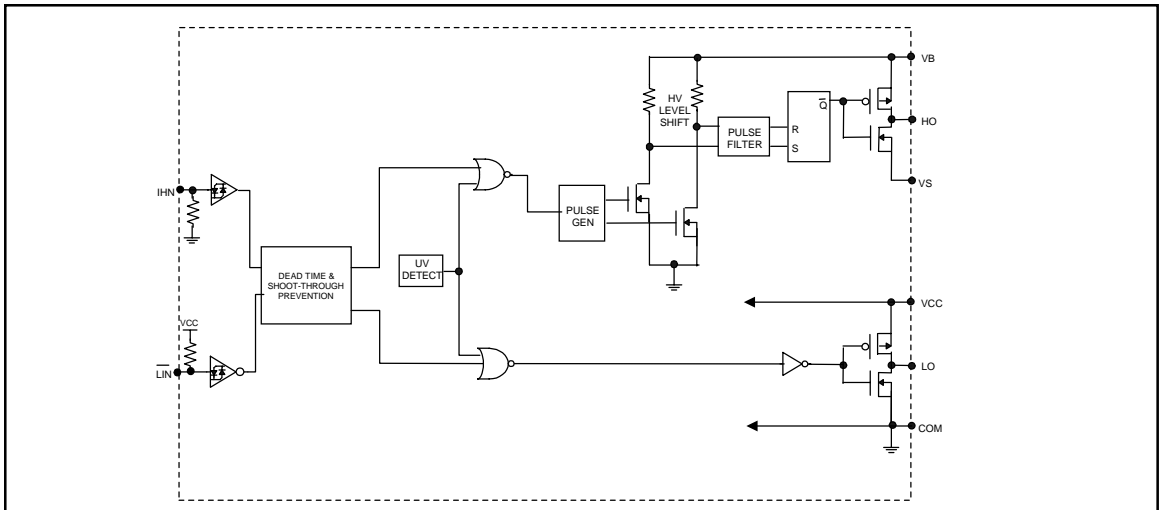

Lead Definitions

| Symbol | Description |
|-------------------------|--|
| HIN | Logic input for high-side gate driver output (HO), in phase |
| $\overline{\text{LIN}}$ | Logic input for low-side gate driver output (LO), out of phase |
| VB | High-side floating supply |
| HO | High-side gate drive output |
| VS | High-side floating supply return |
| VCC | Low-side and logic fixed supply |
| LO | Low-side gate drive output |
| COM | Low-side return |

Lead Assignments

| | |
|--------------------|--------------------|
| <p>8 Lead PDIP</p> | <p>8 Lead SOIC</p> |
| IRS2103PbF | IRS2103SPbF |

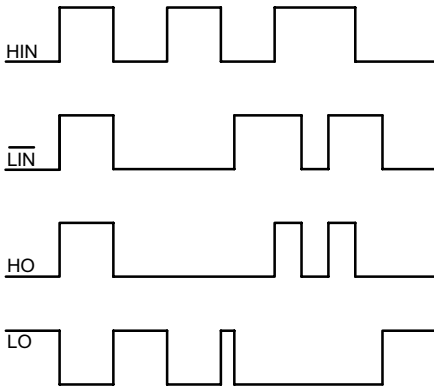

Figure 1. Input/Output Timing Diagram

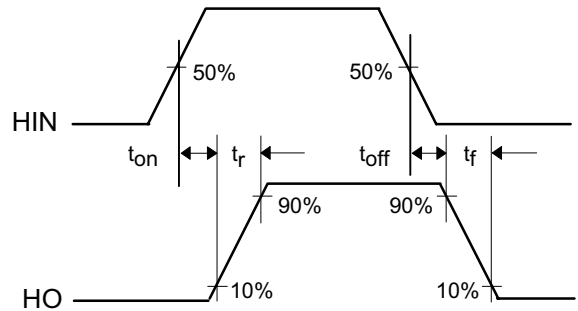
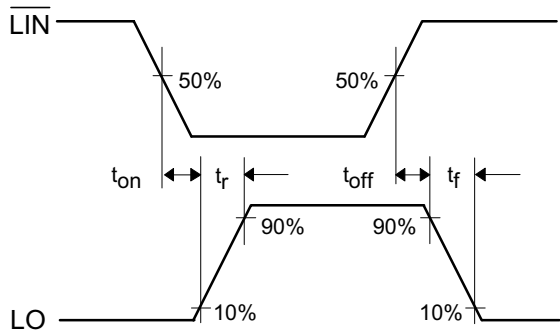

Figure 2. Switching Time Waveform Definitions

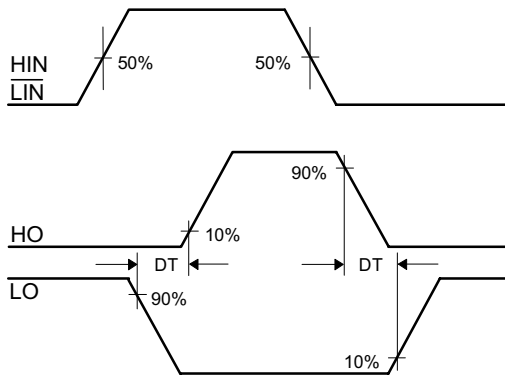

Figure 3. Deadtime Waveform Definitions

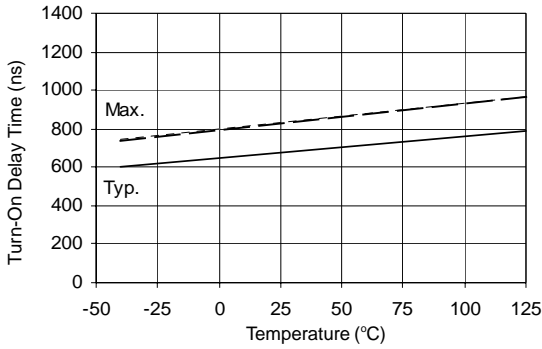

Figure 4A. Turn-On Time vs. Temperature

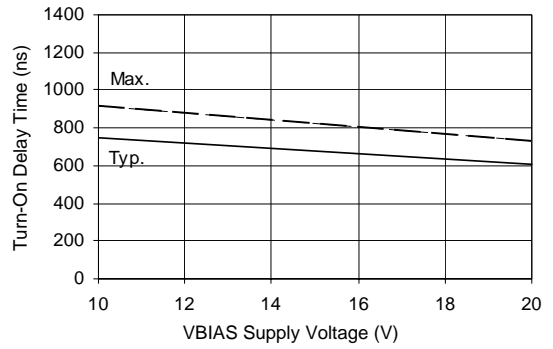

Figure 4B. Turn-On Time vs. Supply Voltage

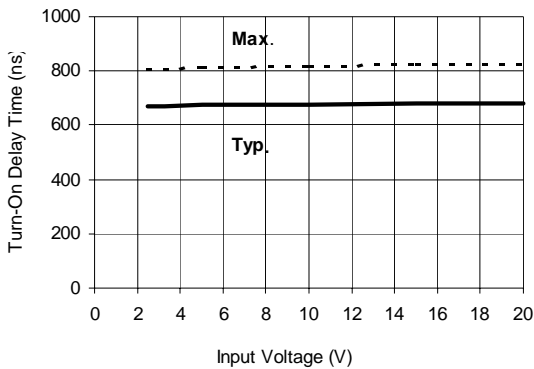

Figure 4C. Turn-On Time vs. Input Voltage

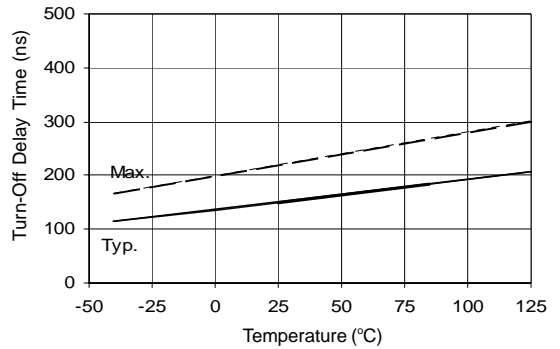

Figure 5A. Turn-Off Time vs. Temperature

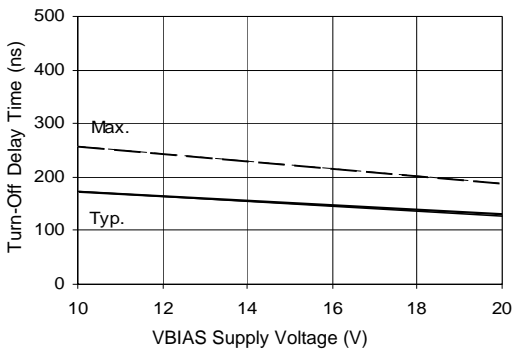

Figure 5B. Turn-Off Time vs. Supply Voltage

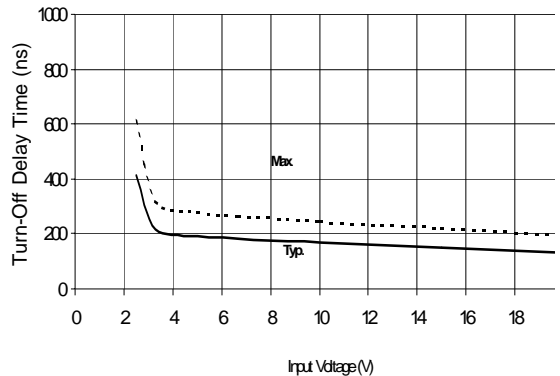

Figure 5C. Turn-Off Time vs. Input Voltage

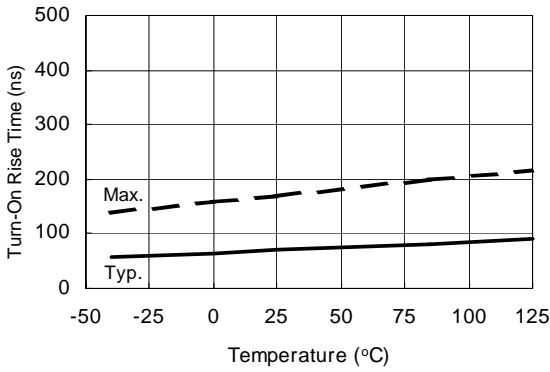

Figure 6A. Turn-On Rise Time vs. Temperature

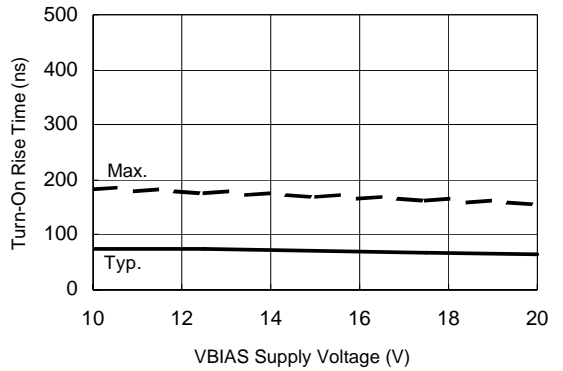

Figure 6B. Turn-On Rise Time vs. Voltage

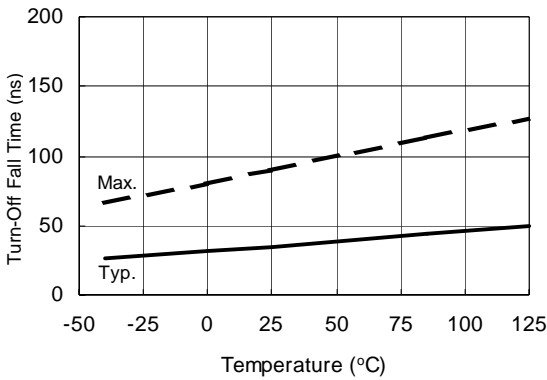

Figure 7A. Turn-Off Fall Time vs. Temperature

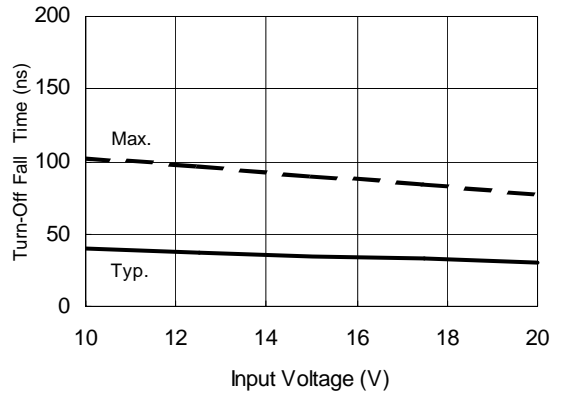

Figure 7B. Turn-Off Fall Time vs. Voltage

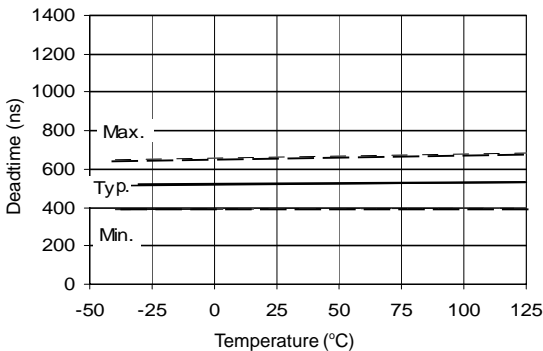

Figure 8A. Deadtime vs. Temperature

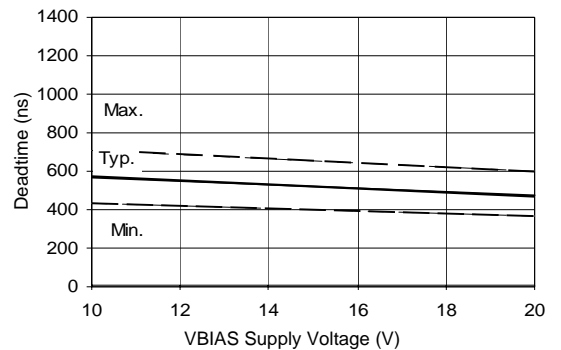

Figure 8B. Deadtime vs. Voltage

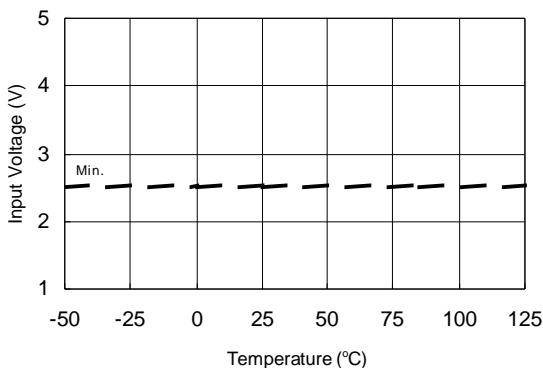

Figure 9A. Logic "1" Input Voltage vs. Temperature

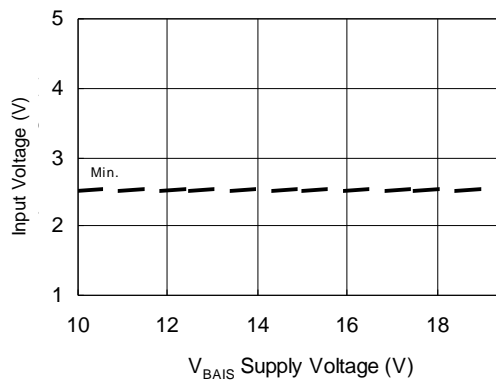

Figure 9B. Logic "1" Input Voltage vs. Supply Voltage

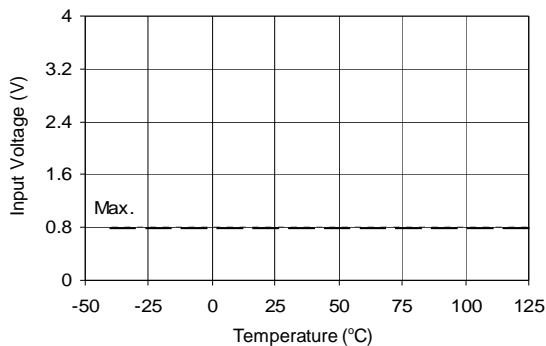

Figure 10A. Logic "0" (HIN) & Logic "1" (LIN) Input Voltage vs. Temperature

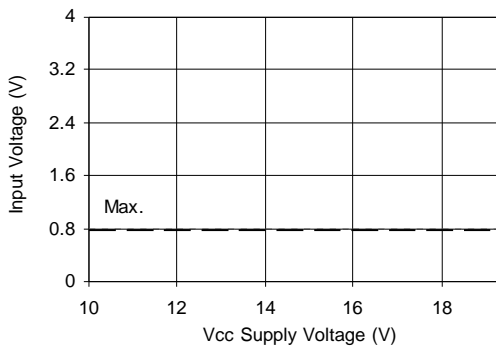

Figure 10B. Logic "0" (HIN) & Logic "1" (LIN) Input Voltage vs. Voltage

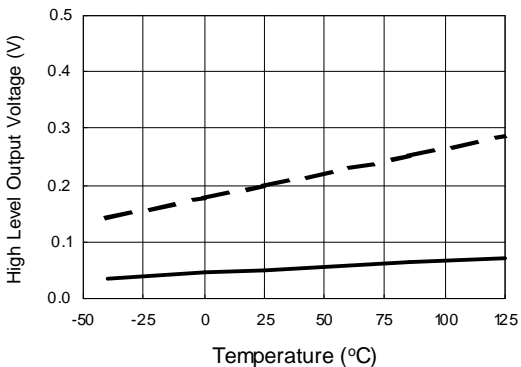

Figure 11A. High Level Output Voltage vs. Temperature

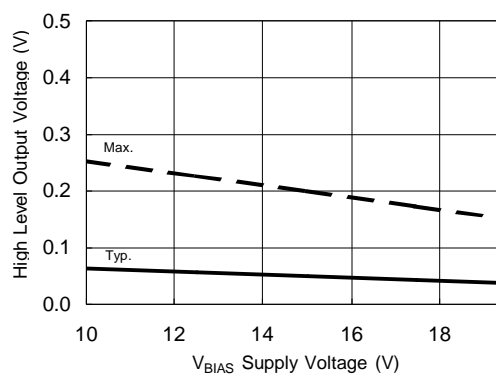

Figure 11B. High Level Output Voltage vs. Supply Voltage

www.irf.com

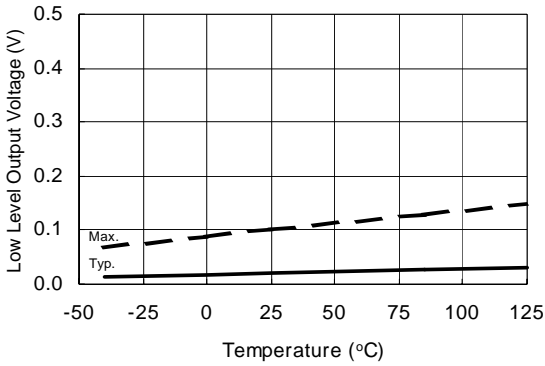

Figure 12A. Low Level Output Voltage vs. Temperature

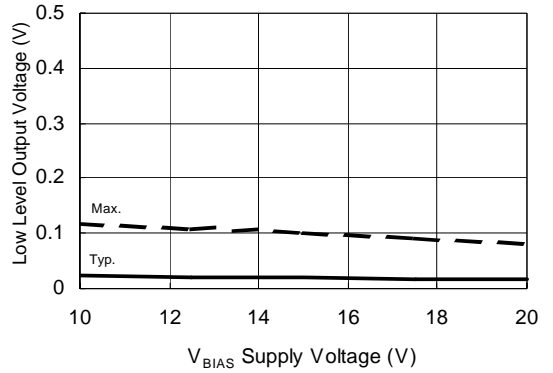

Figure 12B. Low Level Output Voltage vs. Supply Voltage

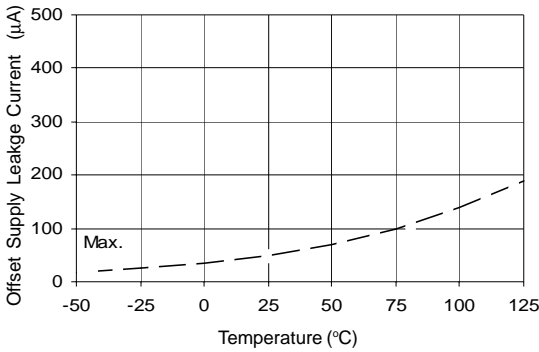

Figure 13A. Offset Supply Current vs. Temperature

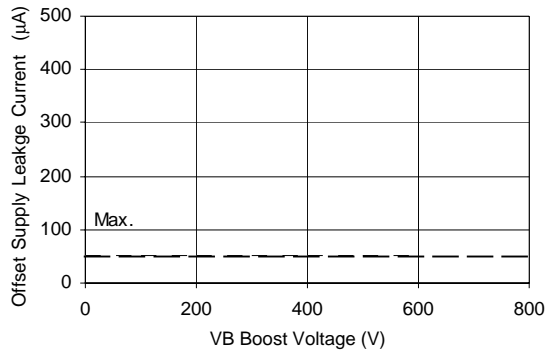

Figure 13B. Offset Supply Current vs. Voltage

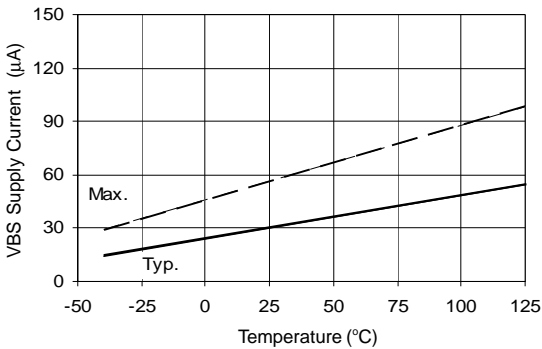

Figure 14A. V_{BS} Supply Current vs. Temperature

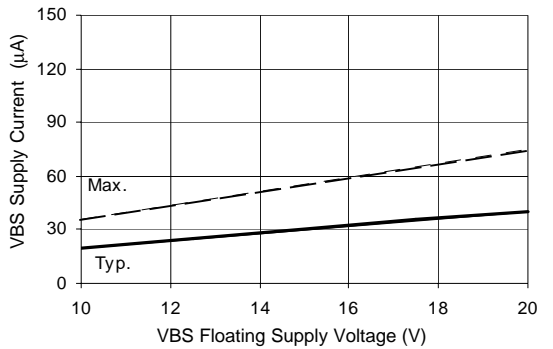

Figure 14B. V_{BS} Supply Current vs. Voltage

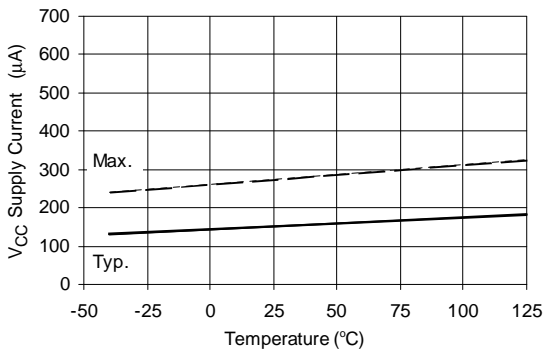

Figure 15A. V_{CC} Supply Current vs. Temperature

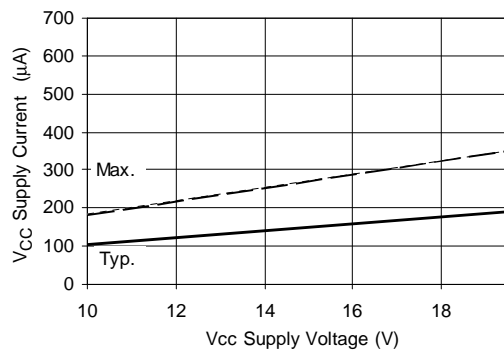

Figure 15B. V_{CC} Supply Current vs. Voltage

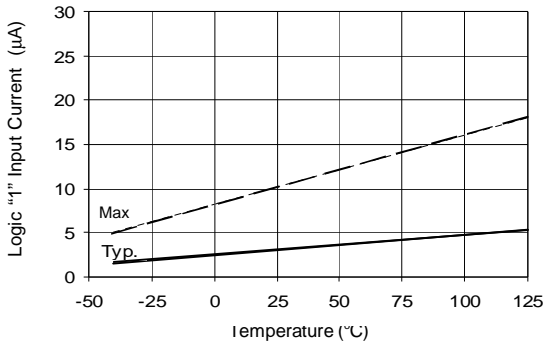

Figure 16A. Logic "1" Input Current vs. Temperature

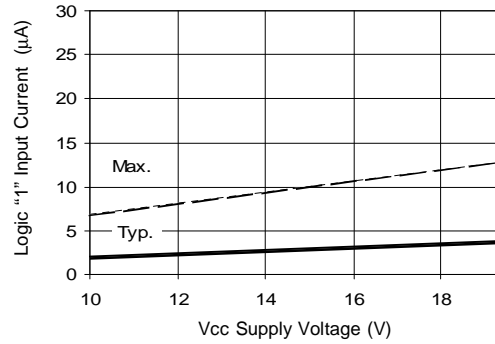

Figure 16B. Logic "1" Input Current vs. Voltage

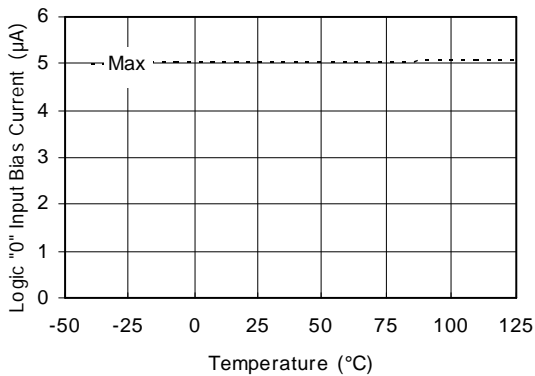

Figure 17A. Logic "0" Input Current vs. Temperature

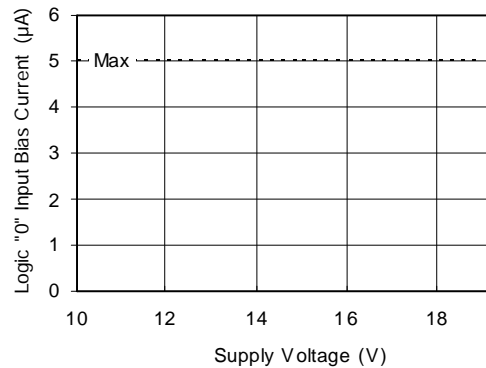

Figure 17B. Logic "0" Input Current vs. Voltage

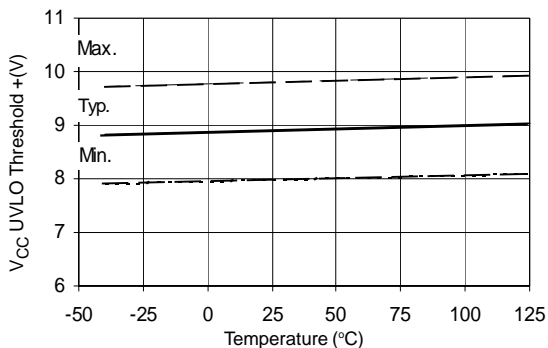

Figure 18A. V_{CC} Undervoltage Threshold(+) vs. Temperature

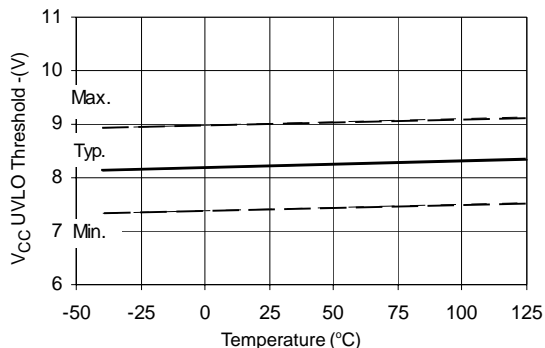

Figure 18B. V_{CC} Undervoltage Threshold(-) vs. Temperature

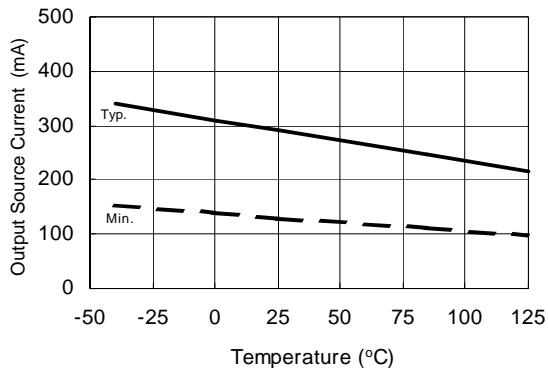

Figure 19A. Output Source Current vs. Temperature

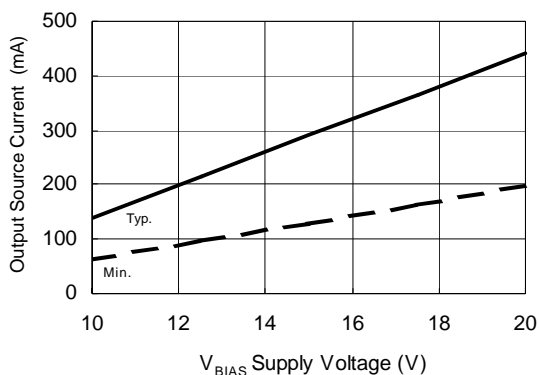

Figure 19B. Output Source Current vs. Supply Voltage

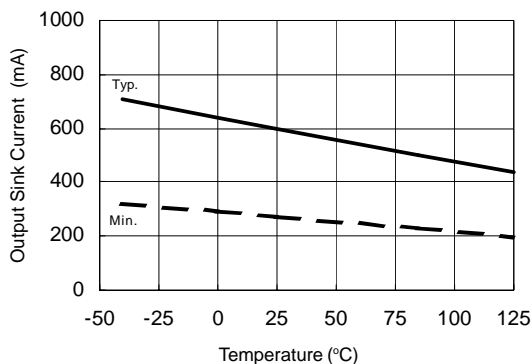

Figure 20A. Output Sink Current vs. Temperature

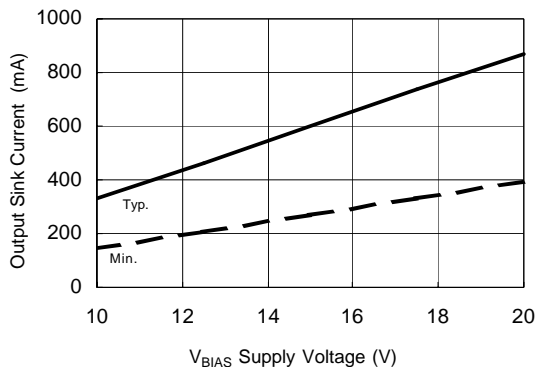
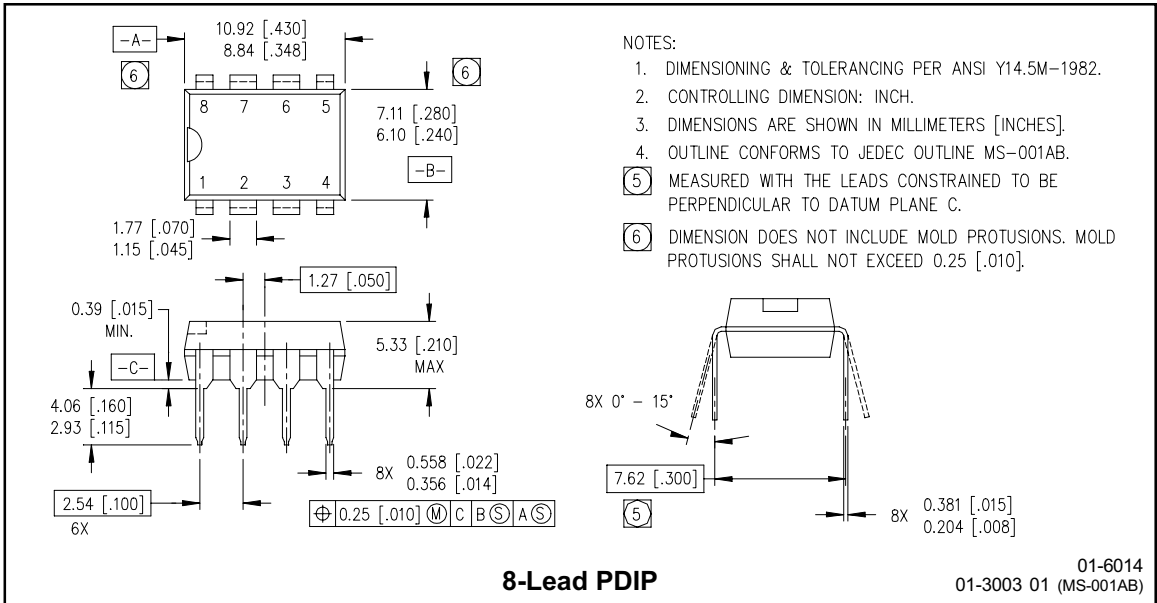
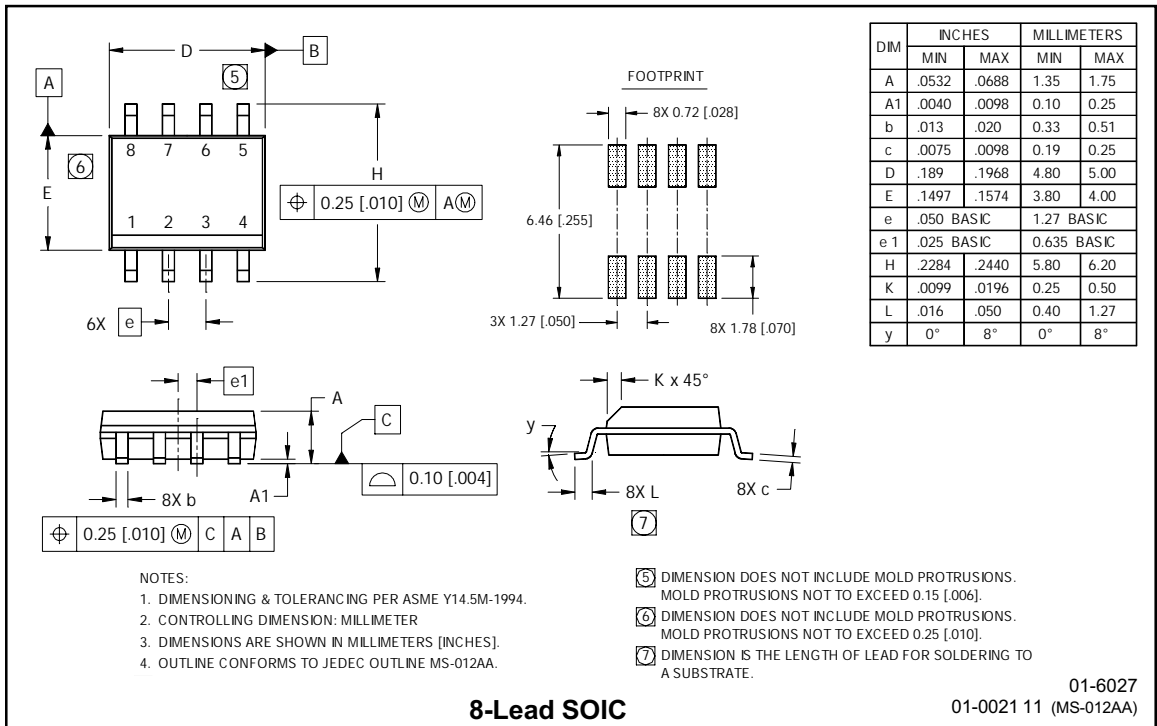

Figure 20B. Output Sink Current vs. Supply Voltage

Case Outlines



8-Lead PDIP



8-Lead SOIC

Tape & Reel 8-lead SOIC

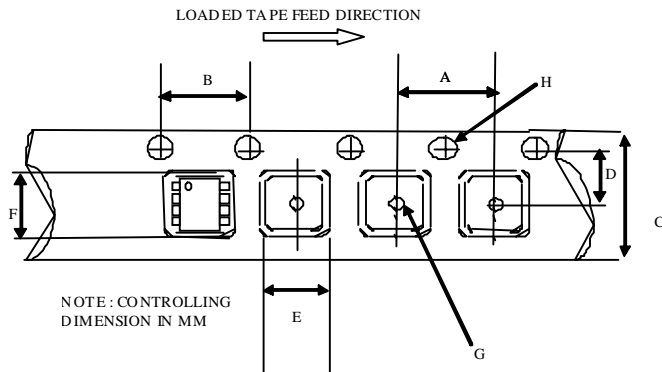

CARRIER TAPE DIMENSION FOR 8SOICN

| Code | Metric | | Imperial | |
|------|--------|-------|----------|-------|
| | Min | Max | Min | Max |
| A | 7.90 | 8.10 | 0.311 | 0.318 |
| B | 3.90 | 4.10 | 0.153 | 0.161 |
| C | 11.70 | 12.30 | 0.46 | 0.484 |
| D | 5.45 | 5.55 | 0.214 | 0.218 |
| E | 6.30 | 6.50 | 0.248 | 0.255 |
| F | 5.10 | 5.30 | 0.200 | 0.208 |
| G | 1.50 | n/a | 0.059 | n/a |
| H | 1.50 | 1.60 | 0.059 | 0.062 |

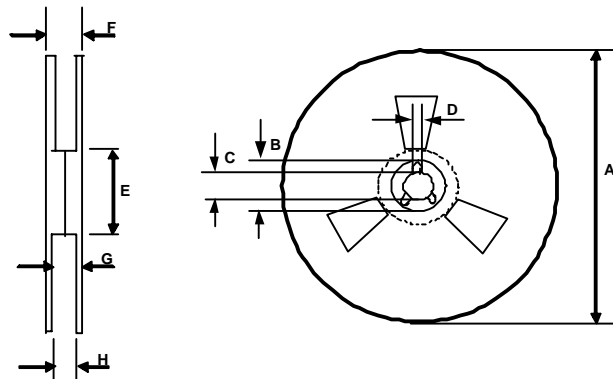

REEL DIMENSIONS FOR 8SOICN

| Code | Metric | | Imperial | |
|------|--------|--------|----------|--------|
| | Min | Max | Min | Max |
| A | 329.60 | 330.25 | 12.976 | 13.001 |
| B | 20.95 | 21.45 | 0.824 | 0.844 |
| C | 12.80 | 13.20 | 0.503 | 0.519 |
| D | 1.95 | 2.45 | 0.767 | 0.096 |
| E | 98.00 | 102.00 | 3.858 | 4.015 |
| F | n/a | 18.40 | n/a | 0.724 |
| G | 14.50 | 17.10 | 0.570 | 0.673 |
| H | 12.40 | 14.40 | 0.488 | 0.566 |

LEADFREE PART MARKING INFORMATION

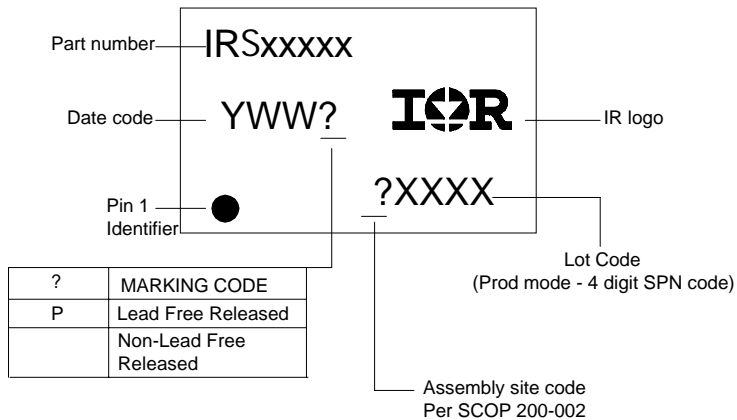

ORDER INFORMATION

8-Lead PDIP IRS2103PbF
 8-Lead SOIC IRS2103SPbF
 8-Lead SOIC Tape & Reel IRS2103STRPbF

X-ON Electronics

Largest Supplier of Electrical and Electronic Components

Click to view similar products for [Gate Drivers](#) category:

Click to view products by [Infineon](#) manufacturer:

Other Similar products are found below :

[89076GBEST](#) [00053P0231](#) [56956](#) [57.404.7355.5](#) [LT4936](#) [57.904.0755.0](#) [5882900001](#) [00600P0005](#) [00-9050-LRPP](#) [00-9090-RDPP](#)
[5951900000](#) [01-1003W-10/32-15](#) [0131700000](#) [00-2240](#) [LTP70N06](#) [LVP640](#) [5J0-1000LG-SIL](#) [LY1D-2-5S-AC120](#) [LY2-US-AC240](#) [LY3-](#)
[UA-DC24](#) [00576P0020](#) [00600P0010](#) [LZN4-UA-DC12](#) [LZNQ2M-US-DC5](#) [LZNQ2-US-DC12](#) [LZP40N10](#) [00-8196-RDPP](#) [00-8274-RDPP](#)
[00-8275-RDNP](#) [00-8609-RDPP](#) [00-8722-RDPP](#) [00-8728-WHPP](#) [00-8869-RDPP](#) [00-9051-RDPP](#) [00-9091-LRPP](#) [00-9291-RDPP](#) [0207100000](#)
[0207400000](#) [01312](#) [0134220000](#) [60713816](#) [M15730061](#) [61161-90](#) [61278-0020](#) [6131-204-23149P](#) [6131-205-17149P](#) [6131-209-15149P](#)
[6131-218-17149P](#) [6131-220-21149P](#) [6131-260-2358P](#)