

ITS42k5D-LD-F

Dual Channel High-Side PMOS Power Switch with Integrated Freewheeling Diodes

Data Sheet

Rev 1.0, 2015-04-28

Standard Power



1 Overview

Features

- Two channel power PMOS high-side switch
- Integrated freewheeling diode
- Output current capability: up to 250mA per channel
- Wide operating voltage range: 4.5V to 42V
- Very low quiescent current in OFF state
- High current limit accuracy
- 3.3V and 5V compatible logic inputs
- Optimized EMC behavior
- Overload, short circuit, open load and overtemperature diagnosis
- ESD, short circuit, safe operation area and overtemperature protection
- Undervoltage lockout (UVLO)
- Green and robust product (RoHS compliant)

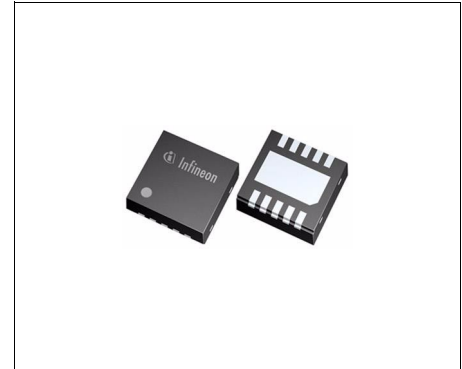

PG-TSON-10

Description

The ITS42k5D-LD-F, which is available in a very small leadless PG-TSON-10 package, is a 2.5Ω dual channel high-side PMOS power switch with integrated freewheeling diodes including protection and diagnostic functions. The ITS42k5D-LD-F has two diagnostic status output pins, one for each channel.

The diagnosis can be read out from two separate open drain outputs in order to indicate overload, short circuit, open load and overtemperature conditions. The device controls the respective channel one or two by the two separate input pins i.e. IN1 and IN2. When both inputs are low the device is in OFF condition. Each channel of the device is able to drive loads up to 250mA.

Application range

The ITS42k5D-LD-F is capable of switching resistive, capacitive and inductive loads (e.g. sensor units, LEDs, relays, valves) in harsh industrial environments. An integrated freewheeling diode enables driving of inductive loads. The ITS42k5D-LD-F is suitable for switching small loads such as sensors. For sensor supplies please refer to Infineon's industrial linear voltage regulator products.

The qualification of this product is based on JEDEC JESD47 and may reference existing qualification results of similar products. Such referencing is justified by the structural similarity of the products. The product is not qualified and manufactured according to the requirements of Infineon Technologies with regard to automotive and/or transportation applications.

Type	Package	Marking
ITS42k5D-LD-F	PG-TSON-10	I2k5DF

Infineon Technologies administrates a comprehensive quality management system according to the latest version of the ISO9001 and ISO/TS 16949.

The most updated certificates of the aforesaid ISO9001 and ISOTS 16949 are available on the Infineon Technologies web page <http://www.infineon.com/cms/en/product/technology/quality/>

2 Pin Configuration

2.1 Pin Assignment

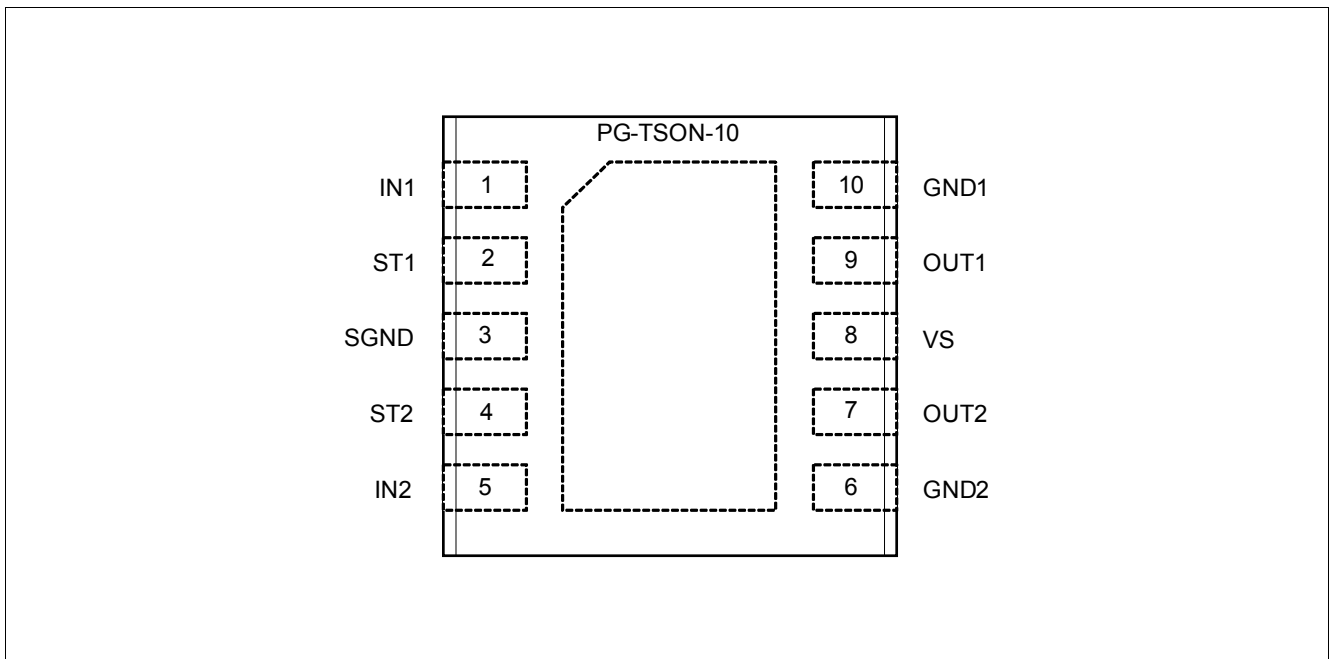

Figure 1 Pin configuration top view, PG-TSON-10

2.2 Pin Definitions and Functions

Table 1 Pin Definition

Pin	Symbol	Function
1	IN1	INPUT 1 ; Control Input for Channel 1, Active High
2	ST1	STATUS 1 ; Status Flag for Channel 1; Open Drain Output
3	SGND	SIGNAL GND ; connect to all GNDs and to exposed GND pad
4	ST2	STATUS 2 ; Status Flag for Channel 2; Open Drain Output
5	IN2	INPUT 2 ; Control Input for Channel 2; Active High
6	GND2	Ground Channel 2 ; Connect to all GNDs and to exposed GND pad
7	OUT2	OUTPUT 2 ; drain of the power-PMOS Channel 2; power freewheeling diode to GND
8	VS	Supply Voltage ; block to GND with a capacitor near the IC
9	OUT1	OUTPUT 1 ; drain of the power-PMOS Channel 1; power freewheeling diode to GND
10	GND1	Ground Channel 1 ; Connect to all GNDs and to exposed GND pad
Exposed pad	–	Connect externally to all GNDs i.e. GND1, GND2 and SGND

3 Block Diagram

3.1 ITS42k5D-LD-F in the PG-TSON-10 package

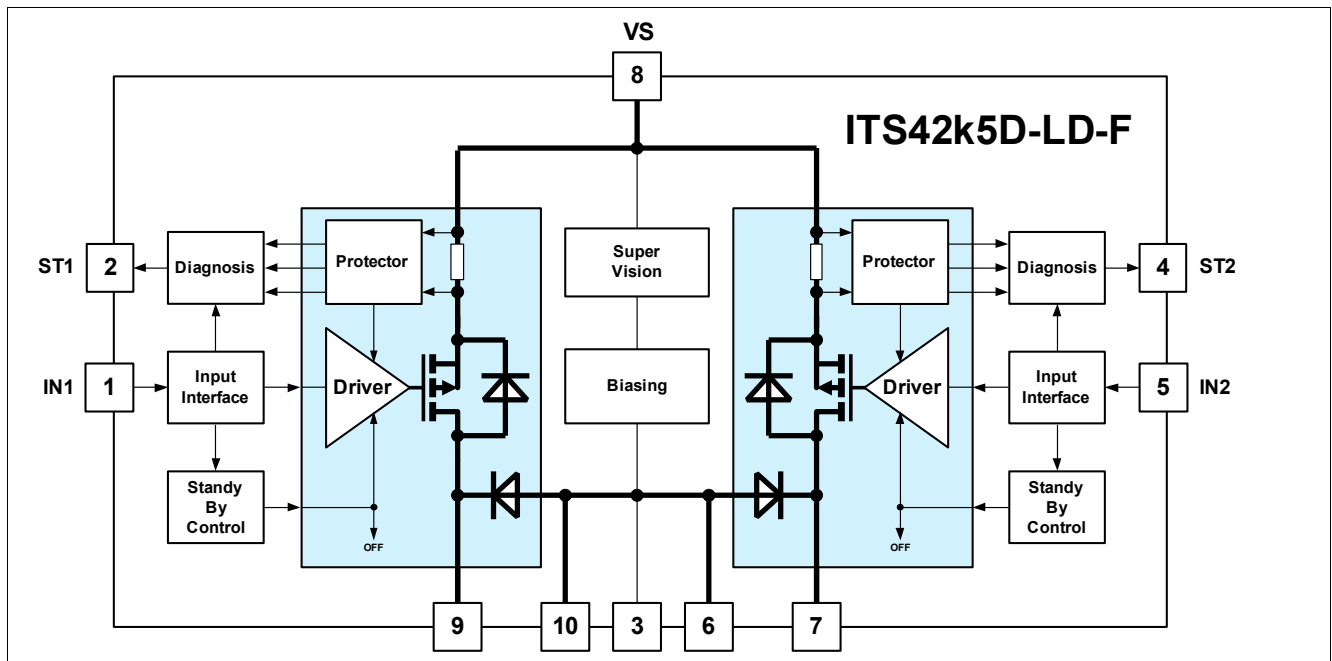

Figure 2 Block diagram ITS42k5D-LD-F

4 Functional Description

4.1 Input Circuit

The two inputs i.e. IN1 and IN2 control the outputs of channel 1 and channel 2 respectively.

When both inputs IN1 and IN2 are low the device is switched OFF. In OFF state, the current consumption of the device is very low. For more details on current consumption in ON and OFF states please refer to electrical characteristics. The logic input levels are compatible with 3.3V and 5V microcontrollers. To avoid switching noise all inputs have hysteresis. Logic level definitions are shown in [Figure 3](#)

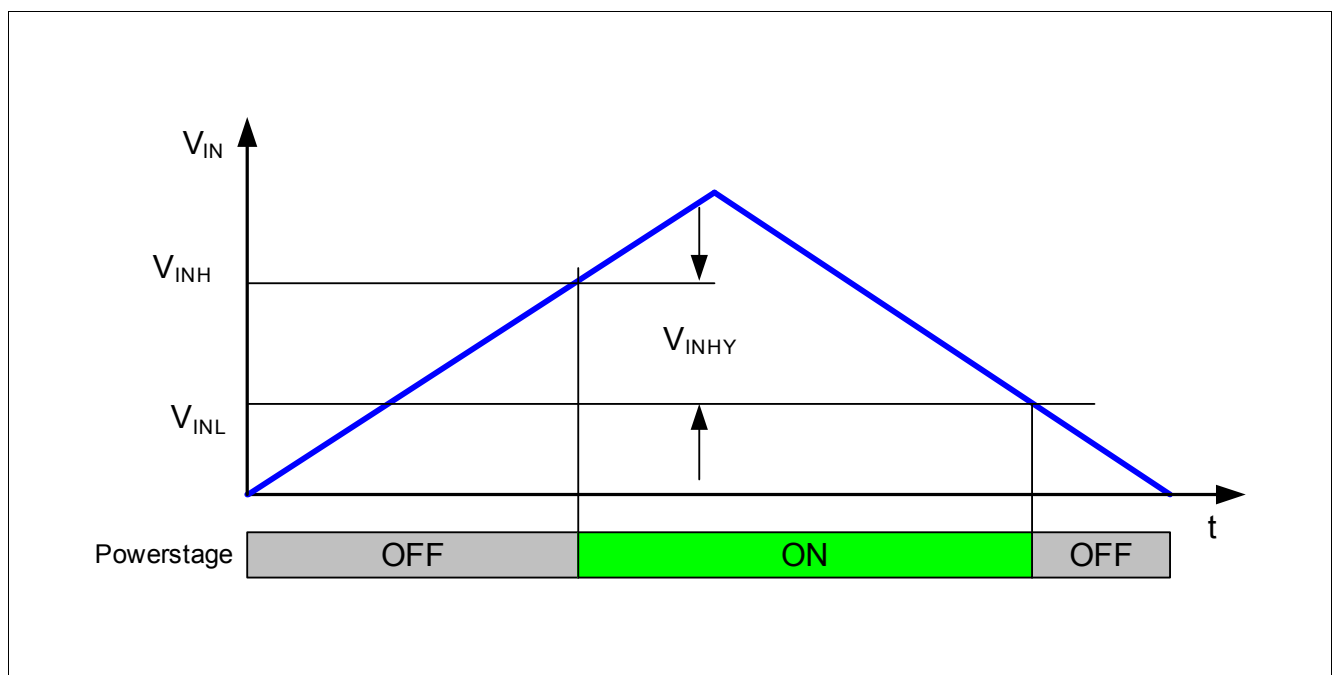

Figure 3 Function and Thresholds of the inputs IN1 and IN2

The input pins are optimized in terms of ESD protection, withstanding overvoltage scenarios like surge pulses. Overvoltage transient levels higher than the maximum ratings of 45V must be avoided.

Note: Exposure to absolute maximum rating conditions for extended periods may affect device reliability.

Integrated protection functions are designed to prevent IC destruction under fault conditions described in the data sheet. Fault conditions are considered as "outside" the normal operating range. Protection functions are neither designed for continuous nor repetitive operation.

4.2 Powerstage

The two outputs are designed as high-side switches with integrated freewheeling diodes from OUT to GND. The high side switch is a power P-channel MOSFET. The integrated freewheeling diodes enable the device to switch inductive loads on each channel.

A built-in high accuracy current limiter ensures that the Power P-channel MOSFET is protected against overload when driving heavy capacitive loads.

[Figure 4](#) shows the output voltage V_{OUT1} and V_{OUT2} controlled by the input interfaces IN1, IN2

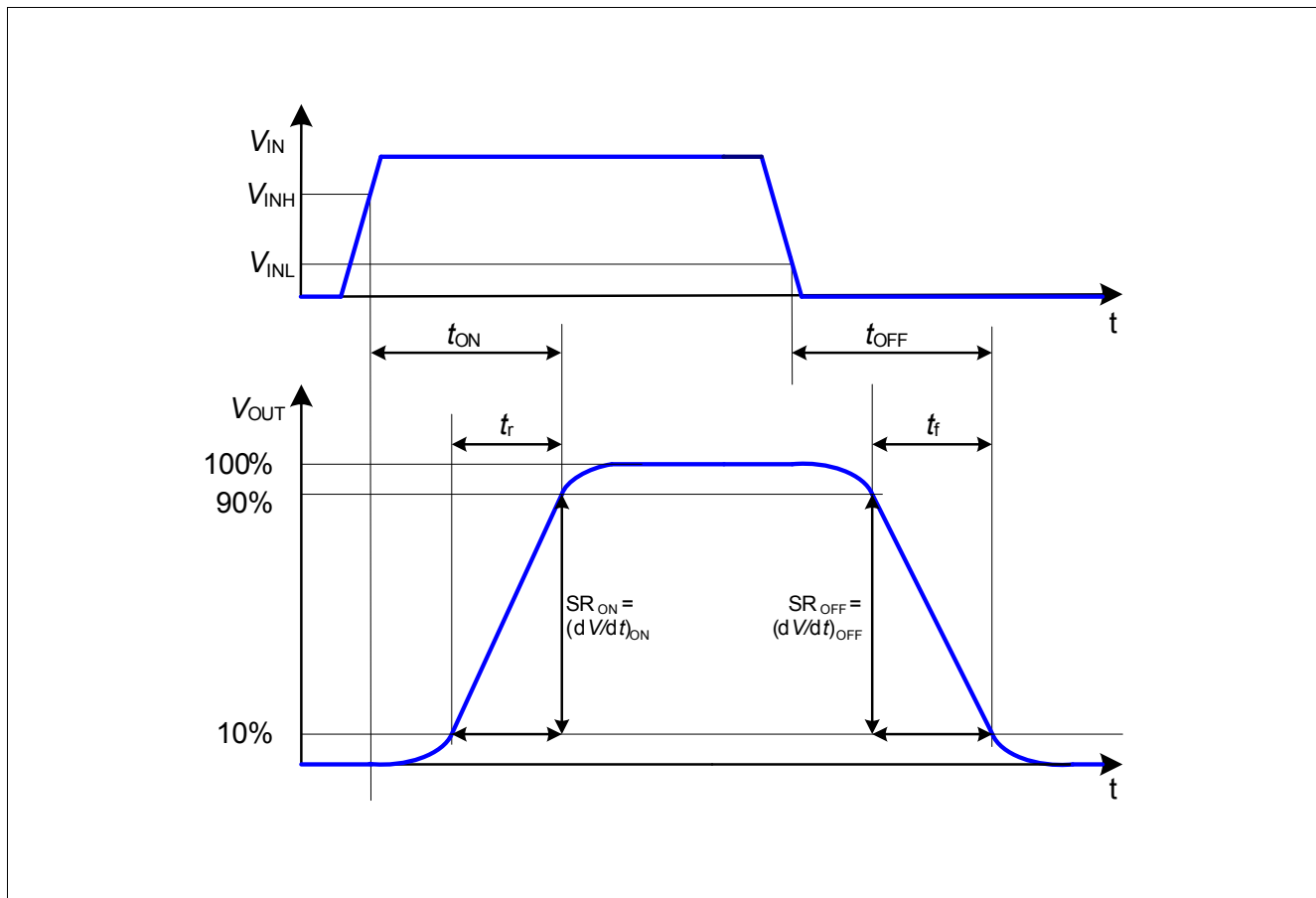

Figure 4 Input / output timings when switching a resistive load.

4.3 Protection Functions

Note: Exposure to absolute maximum rating conditions for extended periods may affect device reliability.

Integrated protection functions are designed to prevent IC destruction under fault conditions described in the data sheet. Fault conditions are considered as “outside” the normal operating range. Protection functions are neither designed for continuous nor repetitive operation.

4.3.1 Short Circuit Protection

Short circuit is a special case of overload. The device is protected within the supply voltage range from $V_S = 4.5$ V to 42 V. If the device stays in short circuit condition for a longer time the integrated temperature protection will switch the device OFF (both channels OFF). For details please look at chapter “Overtemperature Protection”.

4.3.2 Protection by Overtemperature Shutdown

This circuit monitors the junction temperature T_j . When the device is ON, the junction temperature T_j increases proportional to the power loss. The temperature protector is equipped with two temperature sensors, one for each one of the powerstages. When the thermal shutdown trip point T_{SDOFF} is reached, the in-built protector switches OFF the respective channel. This overtemperature shutdown is reported via diagnosis to the respective status flag i.e. either ST1 and ST2. The output remains OFF until the junction is cooled down to the thermal shutdown release point T_{SDON} . If the overload condition remains the device will toggle between both junction temperature values. It is not recommended for the device to stay in an overload condition as this will degrade its lifetime.

4.4 Diagnosis

For diagnostic purposes the device provides two digital output pins ST1 and ST2 in order to indicate fault conditions.

The status flag ST1 indicates the status of channel 1 and flag ST2 indicates the status of channel 2.

Each status output (ST1, ST2) of the ITS42k5D-LD-F is a high voltage open drain output.

In “normal” operation mode the NMOS open drain transistors are switched OFF. The following truth table (Table 2) defines the status output of the device under various conditions.

Table 2 Truth table of diagnosis feature

Device Operation	IN1	IN2	ST1	ST2	Comment
Normal Operation	H	H	H	H	–
Overload	H	H	L	L	Respective flag is low; latched
Short Circuit to GND	H	H	L	L	Respective flag is low; latched
Overtemperature	H	H	L	L	Respective flag is low; latched
Overtemperature	L	L	H	H	Device in OFF mode; no internal heat source
Open Load	H	H	L	L	Respective flag is low

4.5 Undervoltage Lockout

In order to avoid an application malfunction caused by an undervoltage condition at the load (e.g. a relay can not keep the contact closed properly) an undervoltage lockout (UVLO) supervises the supply voltage V_s .

The UVLO circuit switches the power stages off if the supply voltage is below the functional operating voltage range

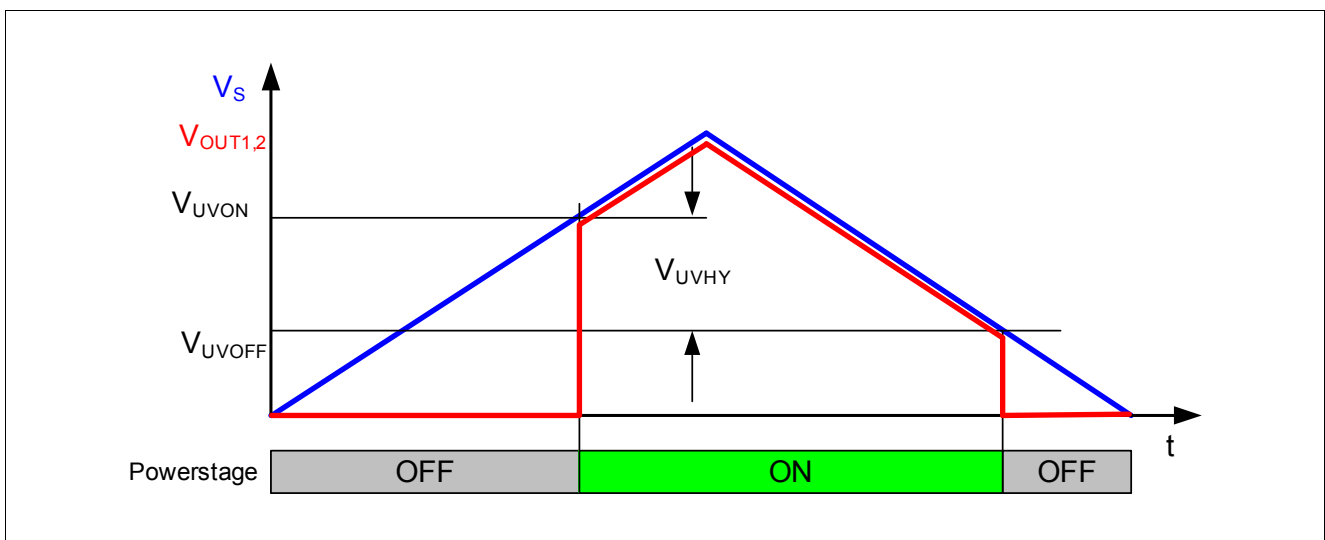

Figure 5 Under Voltage Lockout (UVLO) function and thresholds

4.6 Protection Behavior

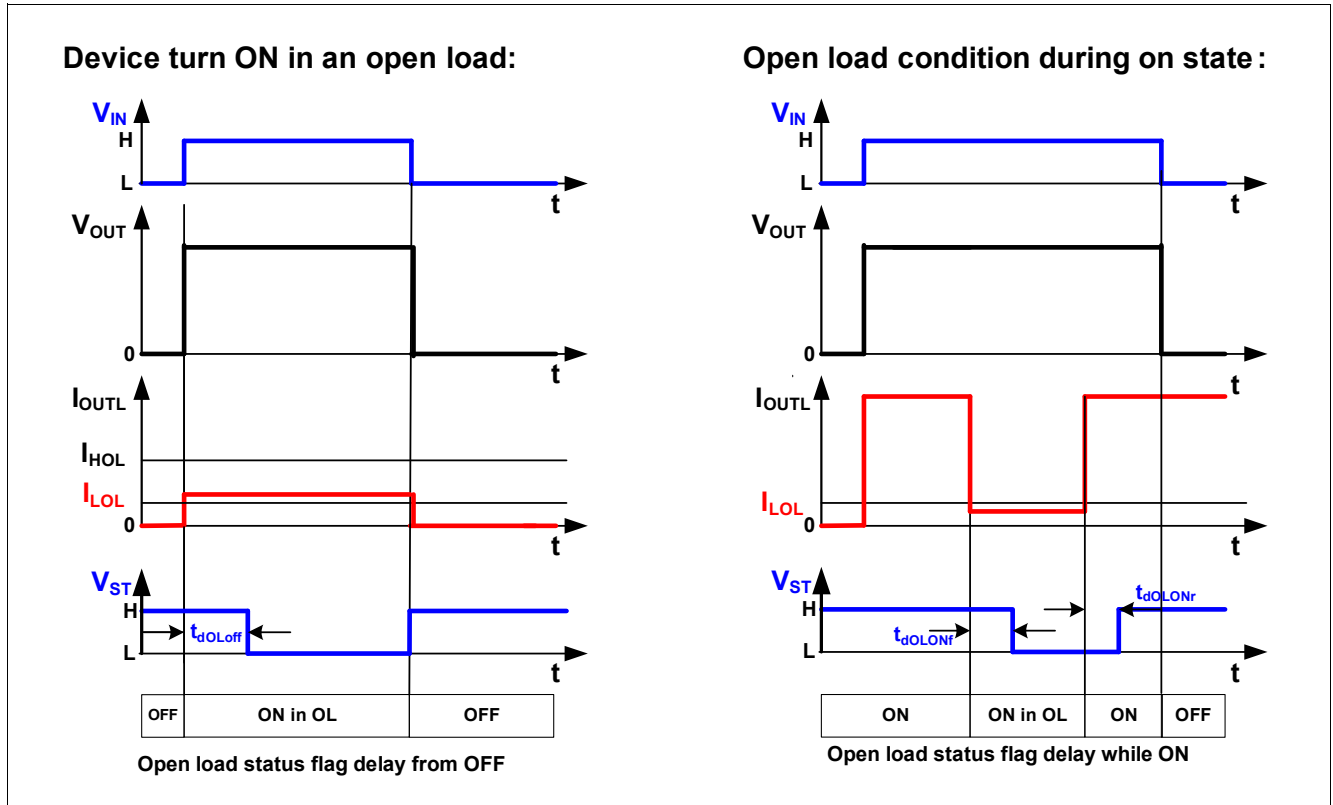

Figure 6 Protection mechanism of the ITS42k5D-LD-F

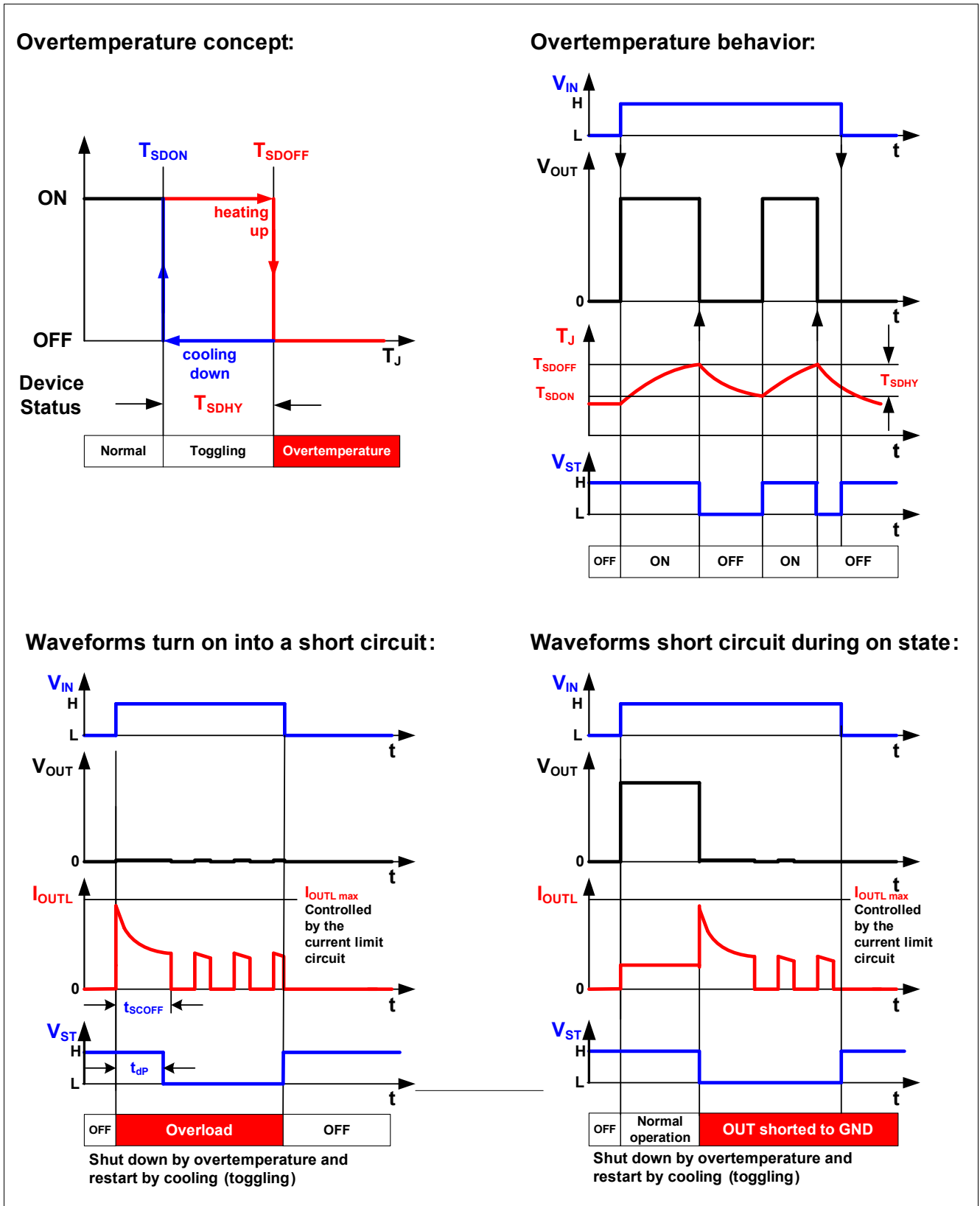

Figure 7 Protection behavior of the ITS42k5D-LD-F

4.7 Application Waveforms

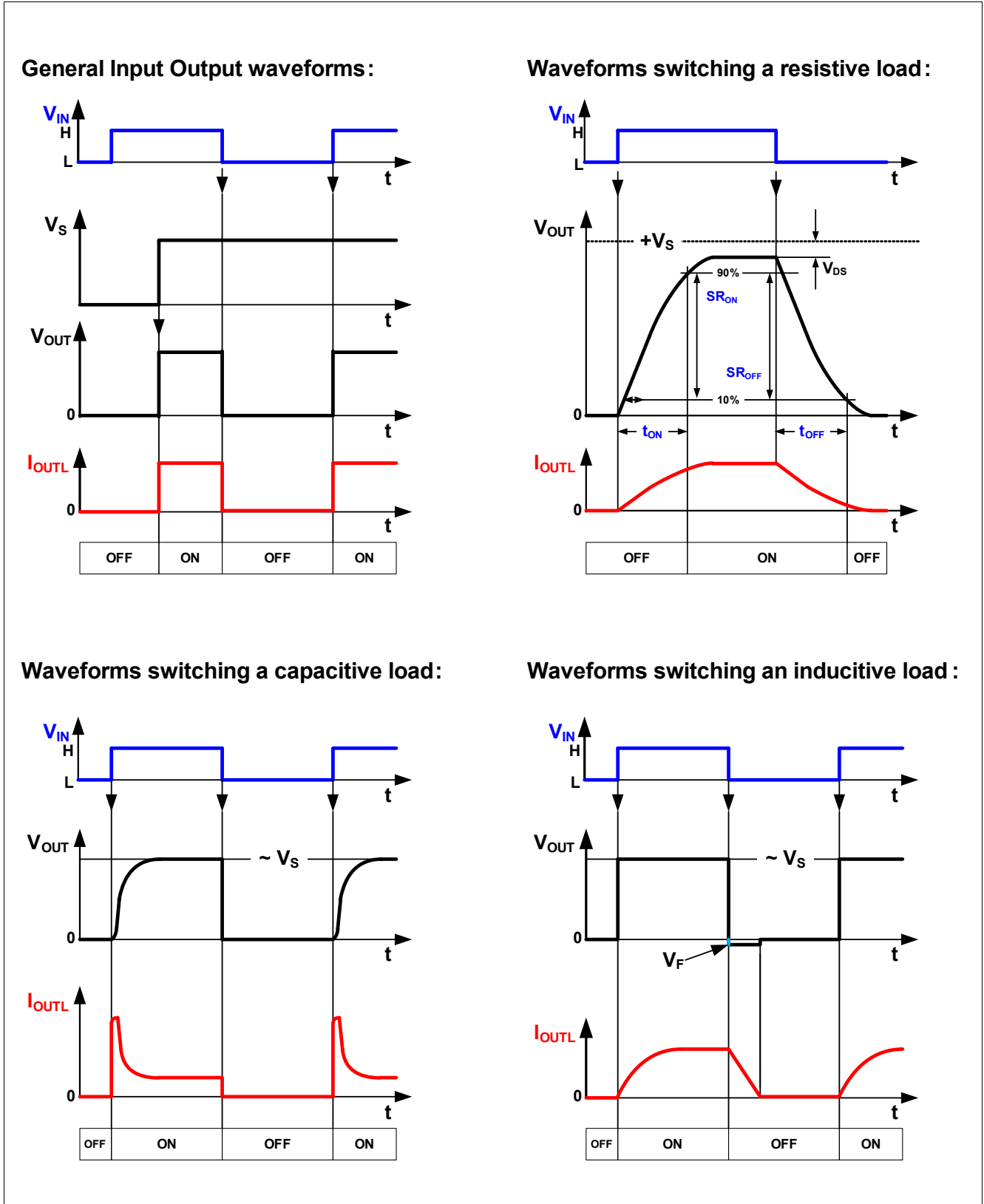

Figure 8 Protection behavior of the ITS42k5D-LD-F

5 General Product Characteristics

5.1 Absolute Maximum Ratings

Table 3 Absolute maximum ratings¹⁾ $T_j = -40^\circ\text{C}$ to $+125^\circ$ unless otherwise specified; all voltages with respect to ground unless otherwise specified

Parameter	Symbol	Values			Unit	Note / Test Condition	Number
		Min.	Typ.	Max.			
Supply voltage VS							
Voltage	V_S	-0.3	–	45	V	–	5.1.1
Current	I_S	-10	–	–	mA	Internally limited	5.1.2
Input IN1 and IN2							
Input Voltage	$V_{IN1,2}$	-0.3	–	45	V	–	5.1.3
Current	$I_{IN1,2}$	–	–	–	mA	Internally limited	5.1.4
Output ST							
Voltage	$V_{ST1,2}$	-0.3	–	45	V	–	5.1.5
Current	$I_{ST1,2}$	–	–	5	mA	–	5.1.6
Ground GND1, GND2, SGND							
Current	$I_{GND1,2}$	–	–	600	mA	Internally limited	5.1.7
Current	I_{SGND}	–	–	10	mA	Internally limited	5.1.8
Output stage OUT1, OUT2							
Voltage	$V_{OUT1,2}$	–	–	$V_S + 0.3$	V	Internally limited	5.1.9
Temperatures							
Junction Temperature	T_j	-40	–	150	$^\circ\text{C}$	–	5.1.11
Storage Temperature	T_{stg}	-55	–	150	$^\circ\text{C}$	–	5.1.12
Power Dissipation							
Power dissipation	P_{tot}	–	0.66	–	W	PCB ²⁾ is vertical without blown air	5.1.13
ESD Susceptibility							
ESD susceptibility (all pins)	V_{ESD}	-2	–	2	kV	HBM ³⁾	5.1.14
ESD susceptibility OUT pins vs. GND pin	V_{ESD}	-2	–	2	kV		5.1.15
ESD susceptibility (all pins)	V_{ESD}	-1	–	1	kV	CDM ⁴⁾	5.1.15

1) Not subject to production test, specified by design

2) See Thermal Resistance Footnote ²⁾

3) ESD susceptibility, HBM according to ANSI/ESDA/JEDEC JS-001 (1.5k Ω , 100pF)

4) ESD susceptibility, Charged Device Model "CDM" JEDEC JESD22-C101

Note: Exposure to absolute maximum rating conditions for extended periods may affect device reliability.

Integrated protection functions are designed to prevent IC destruction under fault conditions described in the data sheet. Fault conditions are considered as "outside" the normal operating range. Protection functions are neither designed for continuous nor repetitive operation.

5.2 Functional Range

Table 4 Functional Range¹⁾

Parameter	Symbol	Values			Unit	Note / Test Condition	Number
		Min.	Typ.	Max.			
Nominal Operating Voltage	V_S	V_{UVON}	–	42	V	V_S increasing	5.2.1
Nominal Operating Voltage	V_S	V_{UVOFF}	–	42	V	V_S decreasing	5.2.2
Nominal Operating Voltage	$V_{IN1,2}$	-0.3	–	7	V	–	5.2.3
Nominal Operating Voltage	$V_{ST1,2}$	-0.3	–	7	V	–	5.2.4
Junction Temperature	T_J	-40	–	125	°C	–	5.2.5

1) Not subject to production test, specified by design

Note: Within the functional range the IC operates as described in the circuit description. The electrical characteristics are specified within the conditions given in the related electrical characteristics table.

5.3 Thermal Resistance

This thermal data was generated in accordance with JEDEC JESD51 standards.

More information on www.jedec.org

Table 5 Thermal Resistance¹⁾

Parameter	Symbol	Values			Unit	Note / Test Condition	Number
		Min.	Typ.	Max.			
PG-TSON-10							
Junction to Case, exposed pad	R_{thjc}	–	12	–	K/W		5.3.1
Junction to ambient	R_{thJA_1s0p}	–	140	–	K/W	²⁾	5.3.2
Junction to ambient	$R_{thJA_1s0p_300mm}$	–	70	–	K/W	³⁾	5.3.3
Junction to ambient	$R_{thJA_1s0p_600mm}$	–	60	–	K/W	⁴⁾	5.3.4
Junction to ambient	R_{thJA_2s2p}	–	67	–	K/W	⁵⁾	5.3.5
Junction to ambient	$R_{thJA_2s2pvia}$	–	55	–	K/W	⁶⁾	5.3.6

1) Not subject to production test, specified by design

2) Specified R_{thJA} value is according to Jedec JESD51-3 at natural convection on FR4 1s0p board, footprint; the Product (Chip+Package) was simulated on a 76.2 x 114.3 x 1.5 mm board with 1x 70µm Cu.

3) Specified R_{thJA} value is according to Jedec JESD51-3 at natural convection on FR4 1s0p board, Cu, 300mm²; the Product (Chip+Package) was simulated on a 76.2 x 114.3 x 1.5 mm board with 1x 70µm Cu.

4) Specified R_{thJA} value is according to Jedec JESD51-3 at natural convection on FR4 1s0p board, 600mm²; the Product (Chip+Package) was simulated on a 76.2 x 114.3 x 1.5 mm board with 1x 70µm Cu.

5) Specified R_{thJA} value is according to Jedec JESD51-2,-5,-7 at natural convection on FR4 2s2p board; the Product (Chip+Package) was simulated on a 76.2 x 114.3 x 1.5 mm board with 2 inner copper layers (2 x 70µm Cu, 2 x 35µm Cu).

6) Specified R_{thJA} value is according to Jedec JESD51-2,-5,-7 at natural convection on FR4 2s2p board with two thermal vias; the Product (Chip+Package) was simulated on a 76.2 x 114.3 x 1.5 mm board with 2 inner copper layers (2 x 70µm Cu, 2 x 35µm Cu). The diameter of the two vias are equal 0.3mm and have a plating of 25µm with a copper heatsink area of 3mm x 2mm). JEDEC51-7: The two plated-through hole vias should have a solder land of no less than 1.25 mm diameter with a drill hole of no less than 0.85 mm diameter.

6 Electrical Characteristics

Table 6 $V_S = 4.5\text{ V to }42\text{ V}$; $T_j = -40^\circ\text{C to }+125^\circ$, all voltages with respect to ground, currents flowing into the device unless otherwise specified ; typical values are given at $V_S = 13.5\text{ V}$, $T_j = 25^\circ\text{C}$

Parameter	Symbol	Values			Unit	Note / Test Condition	Number
		Min.	Typ.	Max.			
Input							
ON Threshold	$V_{INH1,2}$	2	–	–	V	–	6.1.1
OFF Threshold	$V_{INL1,2}$	–	–	0.8	V	–	6.1.2
Input Hysteresis	$V_{INH1,2}$	0.1	0.4	–	V	$V_{INH1,2} = V_{INH} - V_{INL}$	6.1.3
Input Current - ON state	$I_{INON1,2}$	10	25	50	μA	$V_{IN} = 5\text{V}$	6.1.4
Input Pull Down Resistor; IN1,2 to SGND	$R_{IN1,2}$	100	200	300	k Ω	–	6.1.5
Powerstage							
PMOS ON Resistance	$R_{DSON1,2}$	–	2.5	8	Ω	$I_{OUT1,2} = 250\text{mA}$	6.1.6
PMOS ON Resistance	$R_{DSON1,2}$	–	2.5	4	Ω	$I_{OUT1,2} = 250\text{mA}$; $T_j = 25^\circ\text{C}$;	6.1.7
Freewheeling Diode Forward Voltage	$V_{F1,2}$	–	–	1.5	V	$I_{F1,2} = 250\text{mA}$	6.1.8
Freewheeling Diode Forward Voltage	$V_{F1,2}$	–	1.0	1.2	V	$I_{F1,2} = 250\text{mA}$; $T_j = 25^\circ\text{C}$;	6.1.9
Output Leakage Current (PMOS)	$I_{OUTLK1,2}$	–	–	2	μA	$V_{IN1} = V_{IN2} = 0\text{V}$; $V_{OUT1,2} = 0\text{V}$; $T_j = -40^\circ\text{C to }105^\circ\text{C}$	6.1.10
Output Leakage Current (Diode)	$I_{OUTLK1,2}$	-2	–	–	μA	$V_{IN1} = V_{IN2} = 0\text{V}$; $V_{OUT1,2} = V_S$; $T_j = -40^\circ\text{C to }105^\circ\text{C}$	6.1.11
Turn ON Time (to 90% of V_{OUT})	$t_{ON1,2}$	6	12	25	μs	$V_S = 13.5\text{V}$; $R_{L1,2} = 51\Omega$	6.1.12
Turn OFF Time (to 10% of V_{OUT})	$t_{OFF1,2}$	8	16	30	μs	$V_S = 13.5\text{V}$; $R_{L1,2} = 51\Omega$	6.1.13
Rise Time (from 10% to 90% of V_{OUT})	$t_{r1,2}$	3	6	15	μs	$V_S = 13.5\text{V}$; $R_{L1,2} = 51\Omega$	6.1.14
Fall Time (from 90% to 10% of V_{OUT})	$t_{f1,2}$	3	6	15	μs	$V_S = 13.5\text{V}$; $R_{L1,2} = 51\Omega$	6.1.15
Slew Rate ON = dV/dt (10% to 90% of V_{OUT})	$SR_{ON1,2}$	0.7	1.7	3.5	V/ μs	$V_S = 13.5\text{V}$; $R_{L1,2} = 51\Omega$	6.1.16
Slew Rate OFF = $-dV/dt$ (10% to 90% of V_{OUT})	$SR_{OFF1,2}$	0.7	1.7	3.5	V/ μs	$V_S = 13.5\text{V}$; $R_{L1,2} = 51\Omega$	6.1.17
Current consumption							
Quiescent Current in OFF Mode	I_{SOFF}	–	–	1	μA	$T_j = -40^\circ\text{C to }85^\circ\text{C}$; $V_{IN1} = V_{IN2} = 0\text{V}$; $R_{L1,2} = 51\Omega$	6.1.18

Electrical Characteristics
Table 6 $V_S = 4.5\text{ V to }42\text{ V}$; $T_j = -40^\circ\text{C to }+125^\circ\text{C}$, all voltages with respect to ground, currents flowing into the device unless otherwise specified ; typical values are given at $V_S = 13.5\text{ V}$, $T_j = 25^\circ\text{C}$

Parameter	Symbol	Values			Unit	Note / Test Condition	Number
		Min.	Typ.	Max.			
Quiescent Current in OFF Mode	I_{SOFF}	–	–	5	μA	$T_j = -40^\circ\text{C to }105^\circ\text{C}$; $V_{\text{IN}1} = V_{\text{IN}2} = 0\text{V}$; $R_{\text{L}1,2} = 51\Omega$	6.1.19
Current Consumption in ON Mode without load	I_{SON}	–	3	5	mA	$V_{\text{IN}1} = V_{\text{IN}2} = 5\text{V}$; OUT1, 2 open	6.1.20
Current Consumption in ON Mode without load	I_{SON}	–	3	4	mA	$V_{\text{IN}1} = V_{\text{IN}2} = 5\text{V}$; $T_j = 25^\circ\text{C}$; OUT1, 2 open	6.1.21
Current Consumption in ON Mode; with resistive nominal loads $I_{\text{SON}} = I_S - I_{\text{OUT}1} - I_{\text{OUT}2}$	I_{SON}	–	3	5	mA	$V_{\text{IN}1} = V_{\text{IN}2} = 5\text{V}$; $R_{\text{L}1} = R_{\text{L}2} = 51\Omega$; $V_S = 13.5\text{ V}$	6.1.22
Overload Protection Current Limit¹⁾							
Output Current Limitation	$I_{\text{OUTL}1,2}$	250	400	600	mA	$4.5\text{V} < V_{\text{DS}1,2} < 20\text{V}$	6.1.23
Output Current Limitation	$I_{\text{OUTL}1,2}$	200	300	–	mA	$V_{\text{DS}1,2} = 30\text{V}$	6.1.24
Output Current Limitation	$I_{\text{OUTL}1,2}$	50	150	–	mA	$V_{\text{DS}1,2} = 42\text{V}$	6.1.25
Status flag time after positive input slope ²⁾	$t_{\text{dP}1,2}$	–	60	–	μs	–	6.1.26
Overtemperature Protection¹⁾							
Thermal Shutdown Trip Point	T_{SDOFF}	150	175	200	$^\circ\text{C}$	–	6.1.27
Thermal Shutdown Release Point	T_{SDON}	125	150	175	$^\circ\text{C}$	–	6.1.28
Thermal Shutdown Hysteresis	T_{SDHY}	–	25	–	$^\circ\text{C}$	–	6.1.29
Open Load Diagnosis							
Open Load Detection Threshold in ON state; ST going from high to low	I_{LOL}	0.2	3.5	8	mA	$V_S = 13.5\text{V}$ $T_j = 25^\circ\text{C}$	6.1.30
Open Load Detection Threshold in ON state; ST going from low to high	I_{HOL}	1	5	9.5	mA	$V_S = 13.5\text{V}$ $T_j = 25^\circ\text{C}$	6.1.31
Open Load Detection Threshold Hysteresis in ON state	I_{LOLHYS}	0.2	1.5	–	mA	$V_S = 13.5\text{V}$ $T_j = 25^\circ\text{C}$	6.1.32
Status flag time after positive input slope while in Open Load	$t_{\text{dOLOFF}1,2}$	–	18	–	μs	$V_S = 13.5\text{V}$ $T_j = 25^\circ\text{C}$	6.1.33
Status flag time while ON after Open Load event	$t_{\text{dOLONr}1,2}$	–	42	–	μs	$V_S = 13.5\text{V}$ $T_j = 25^\circ\text{C}$	6.1.34
Status flag time while ON going out of Open Load	$t_{\text{dOLONr}1,2}$	–	10	–	μs	$V_S = 13.5\text{V}$ $T_j = 25^\circ\text{C}$	6.1.35
Status Flag							
Status Drop Voltage when L	$V_{\text{STL}1,2}$	–	200	400	mV	$I_{\text{ST}1,2} = 3\text{mA}$	6.1.36
Status Leakage Current when H	$I_{\text{STLK}1,2}$	–	–	10	μA	$V_{\text{ST}1,2} = 7\text{V}$	6.1.37
Undervoltage Lockout							
UV Switch ON Voltage	V_{UVON}	3.75	4.25	4.5	V	V_S increasing	6.1.38
UV Switch OFF Voltage	V_{UVOFF}	3.25	3.75	4.25	V	V_S decreasing	6.1.39
UV ON/OFF Hysteresis	V_{UVHY}	0.2	0.5	–	V	$V_{\text{UVON}} - V_{\text{UVOFF}}$	6.1.40

- 1) Please refer to chapter **"Protection Functions" on Page 7**
- 2) No delay time after overtemperature switch off and short circuit in on-state.

7 Typical Performance Graphs

Typical Performance Characteristics

On-Resistance R_{DSON} versus Junction Temperature T_j

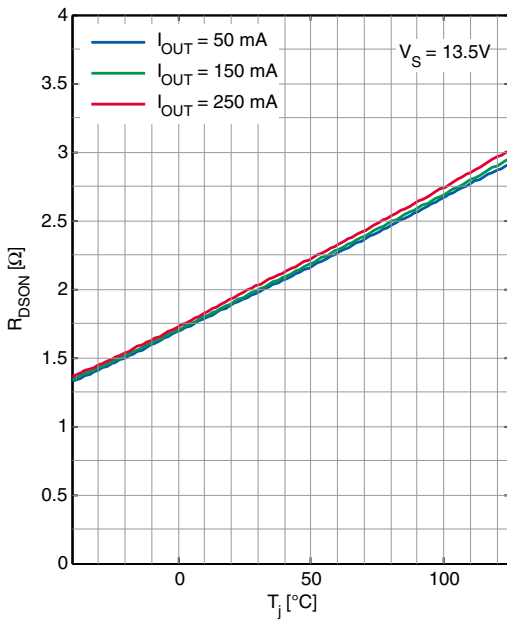

On-Resistance R_{DSON} versus Supply Voltage V_S

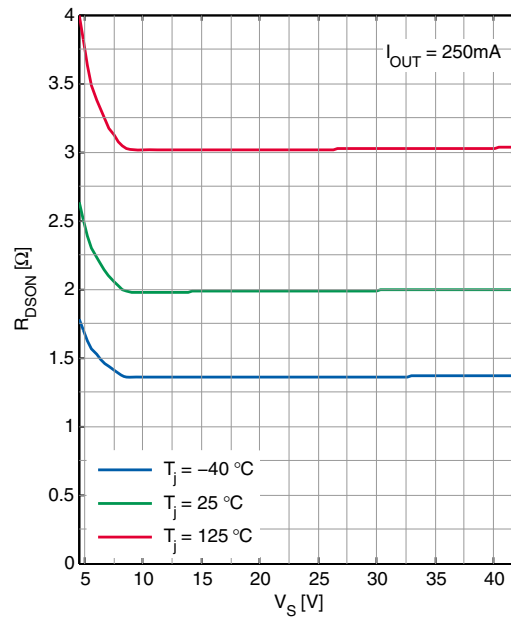

Switch ON Time t_{ON} versus Junction Temperature T_j

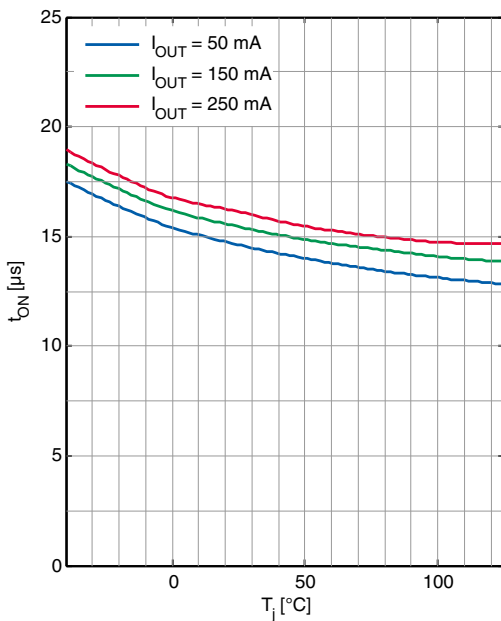

Switch OFF Time t_{OFF} versus Junction Temperature T_j

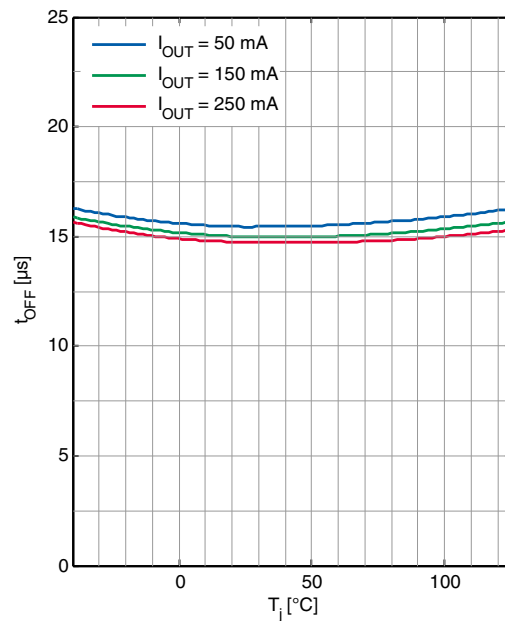

Typical Performance Graphs

Typical Performance Characteristics

Output Rise Time t_r versus Load Current I_{OUT}

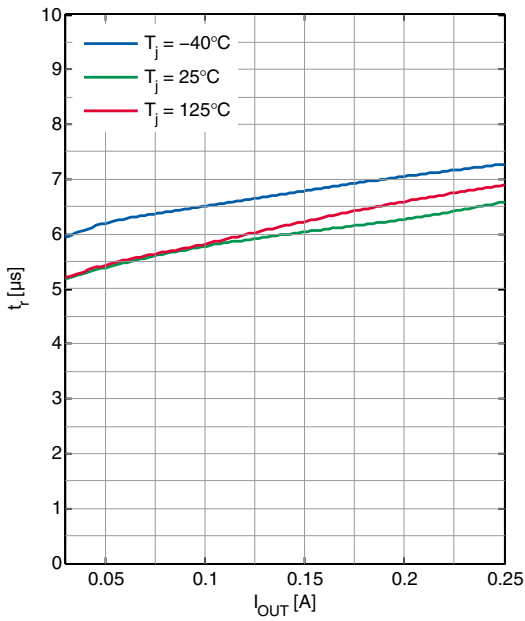

Output Fall Time t_f versus Load Current I_{OUT}

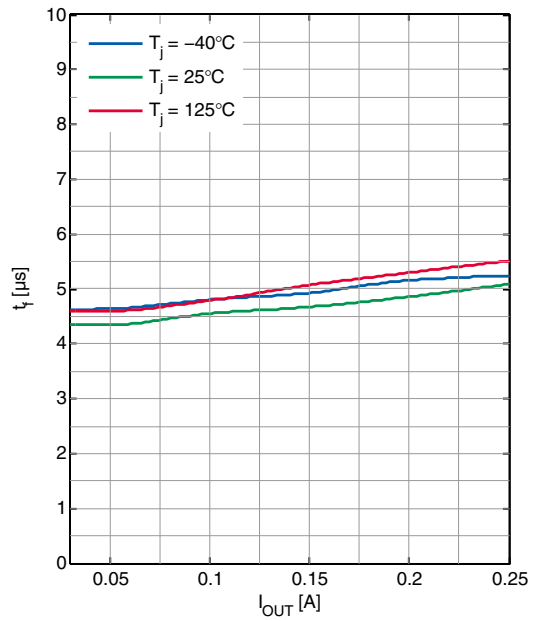

ON Slewrate SR_{ON} versus Junction Temperature T_j

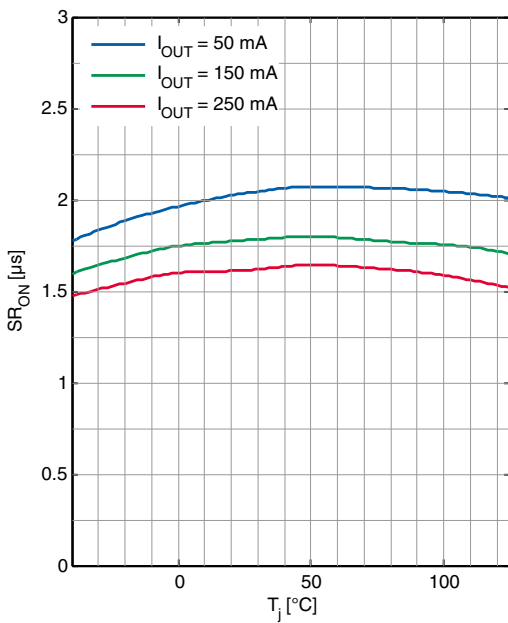

OFF Slewrate SR_{OFF} versus Junction Temperature T_j

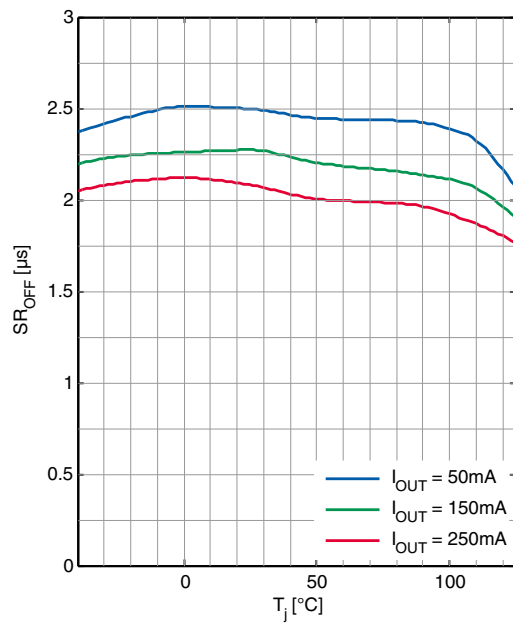

Typical Performance Characteristics

ON Supply Current I_{SON} versus Junction Temperature T_j

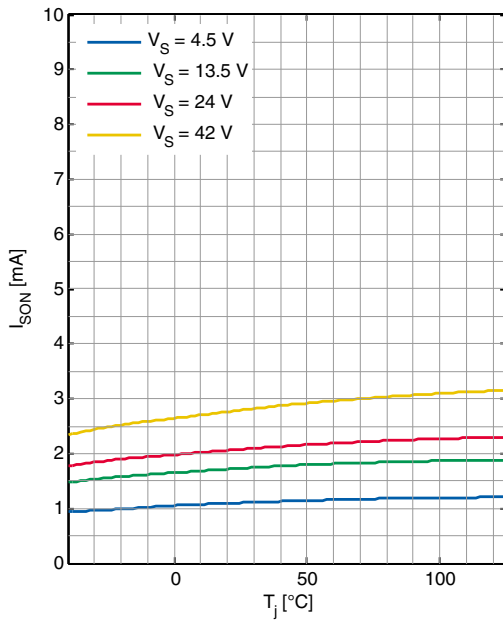

ON Supply Current I_{SON} versus Supply Voltage V_S

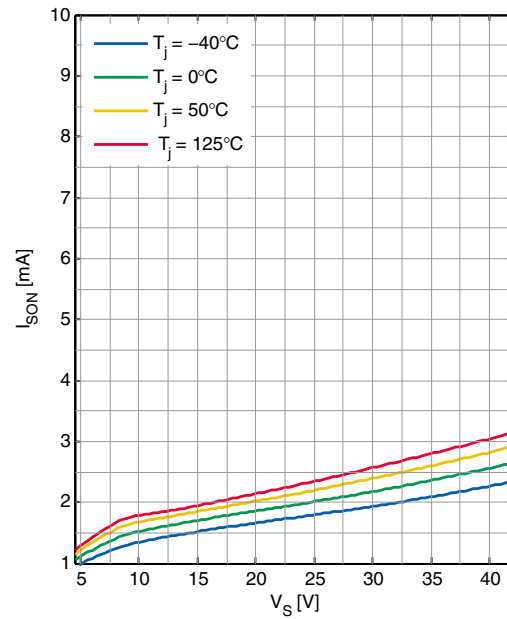

Quiescent Current in OFF mode I_{SOFF} versus Junction Temperature T_j

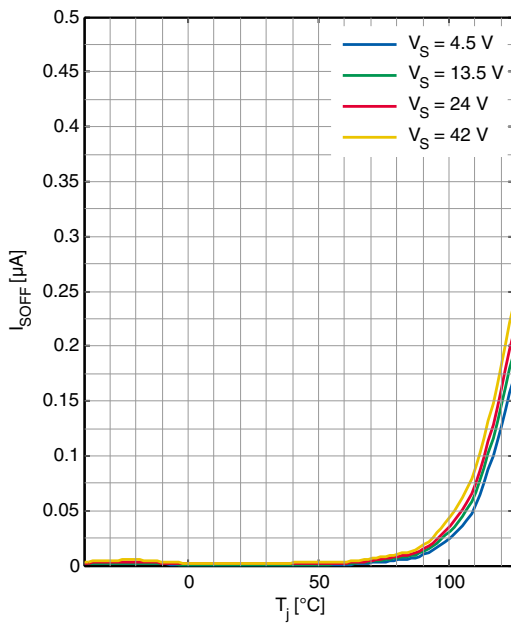

Quiescent Current in OFF mode I_{SOFF} versus Supply Voltage V_S

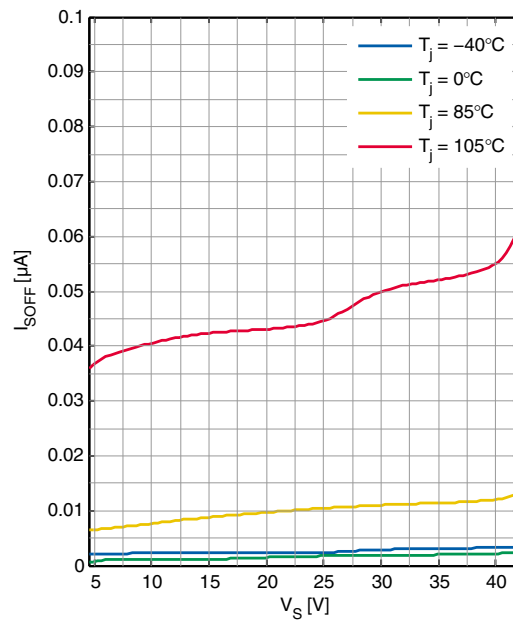

Typical Performance Characteristics

Input Current Consumption I_{IN} versus Junction Temperature T_j

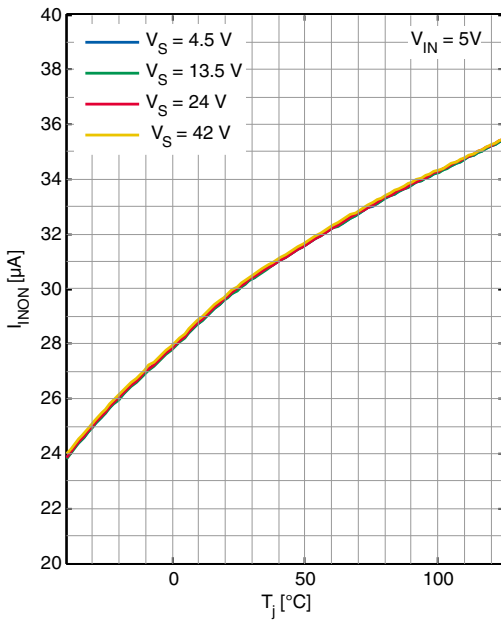

Input Current Consumption I_{IN} versus Input voltage V_{IN}

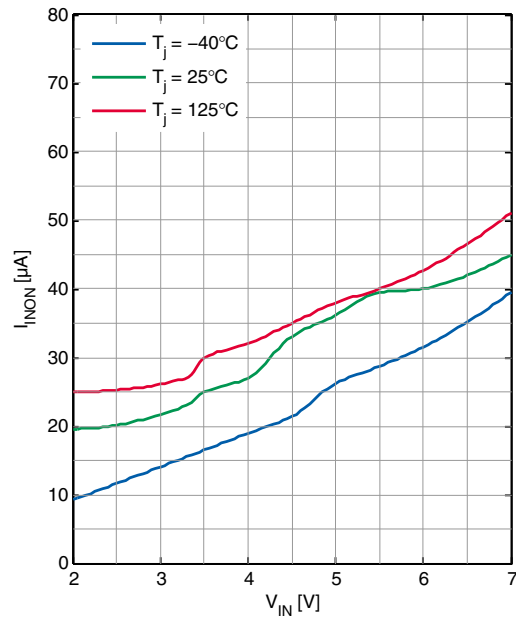

Input Threshold voltage V_{INL} versus Supply Voltage V_S

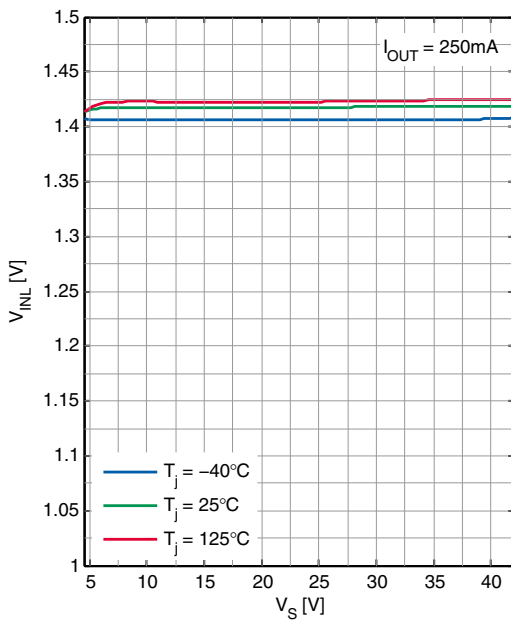

Input Threshold voltage V_{INH} versus Supply Voltage V_S

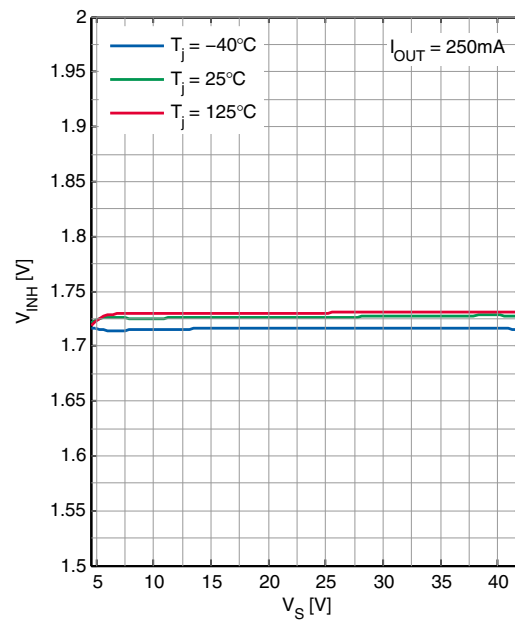

Typical Performance Characteristics

Input Threshold voltage $V_{IN,H,L}$ versus Junction Temperature T_j

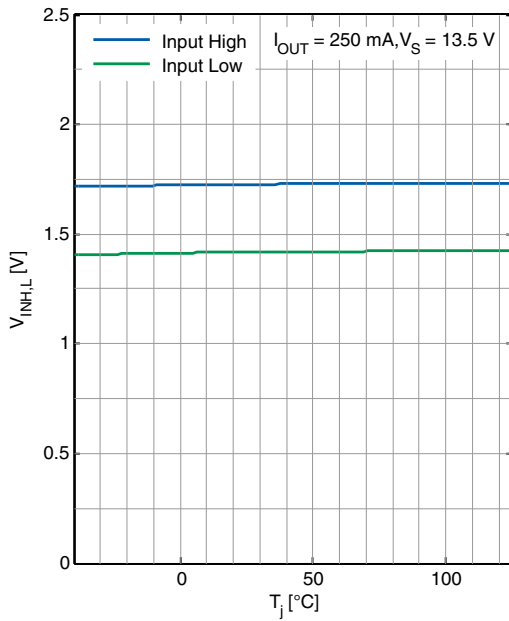

Status Flag Delay time in Open Load condition $t_{dO,OFF}$ versus Supply Voltage V_S

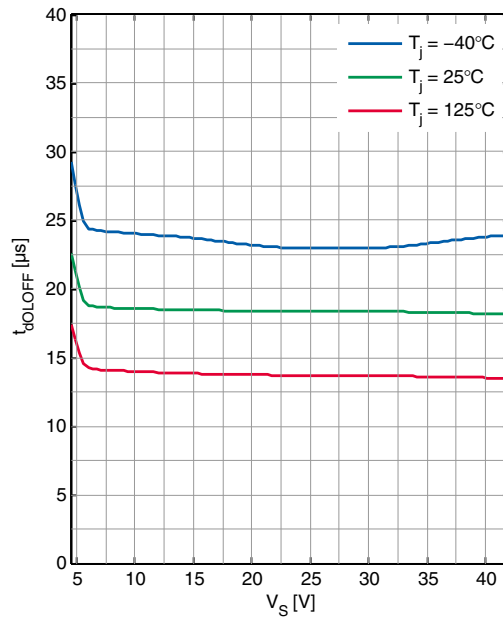

Status Flag Delay time while ON going out of Open Load condition $t_{dO,ONr}$ versus Supply Voltage V_S

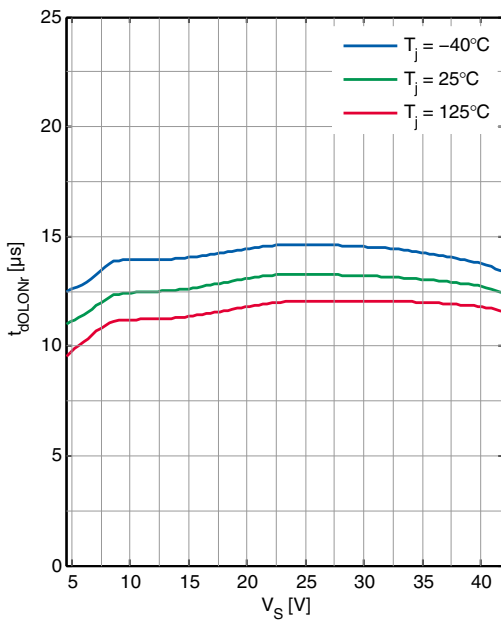

Status Flag Delay time while ON after Open Load event $t_{dO,ONf}$ versus Supply Voltage V_S

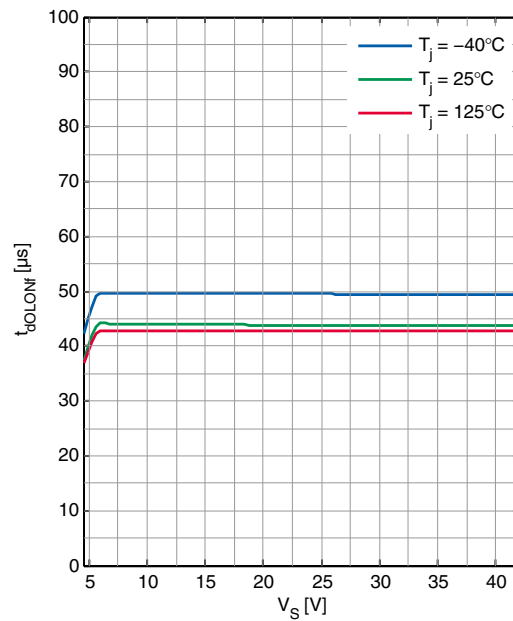

Typical Performance Characteristics

Status Flag Delay time after positive slope t_{dp} versus Supply Voltage V_S

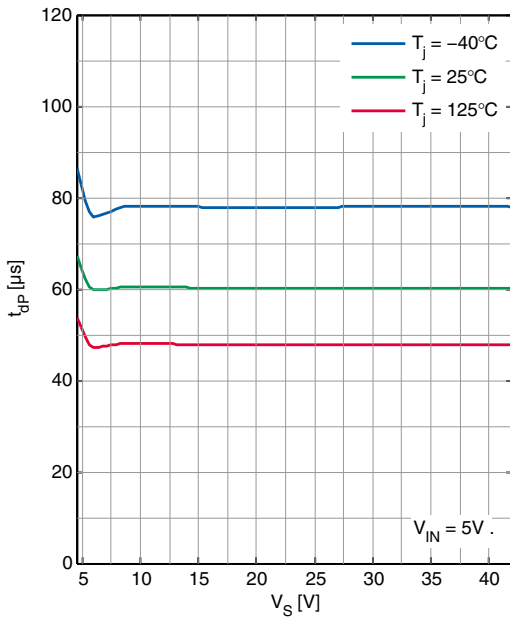

Output Leakage current I_{OUTLK} (PMOS) versus Junction Temperature T_j

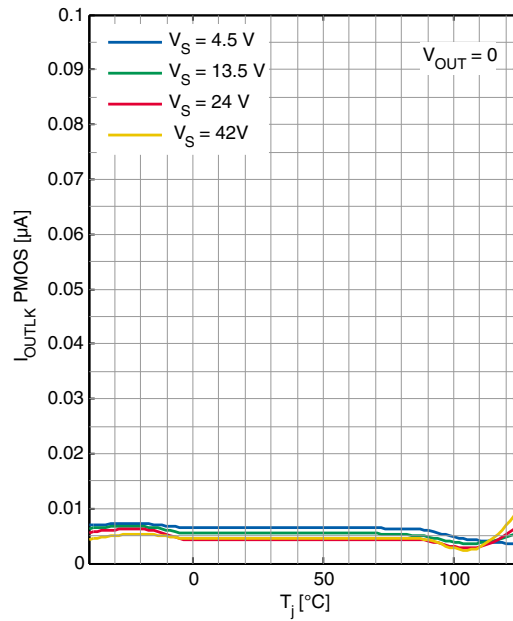

Under Voltage Lockout V_{UVON} , V_{UVOFF} versus Junction Temperature T_j

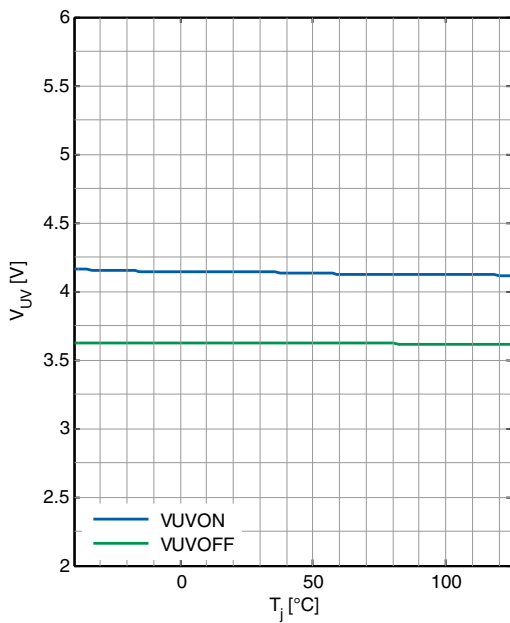

Output Leakage current I_{OUTLK} (Diode) versus Junction Temperature T_j

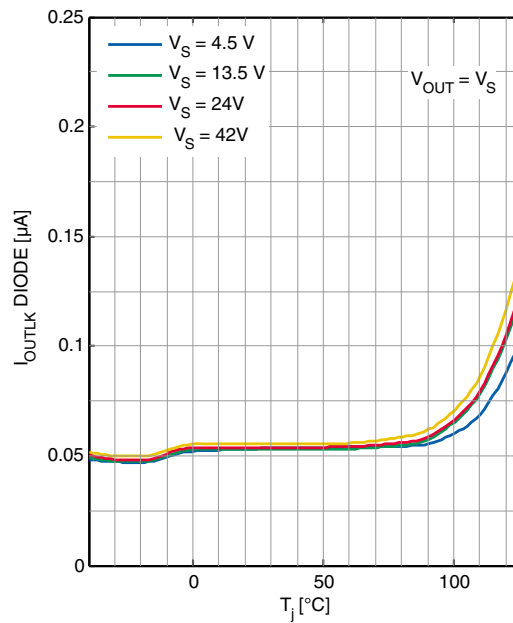

Typical Performance Characteristics

Open Load Current Threshold I_{LOH} versus Supply Voltage V_S

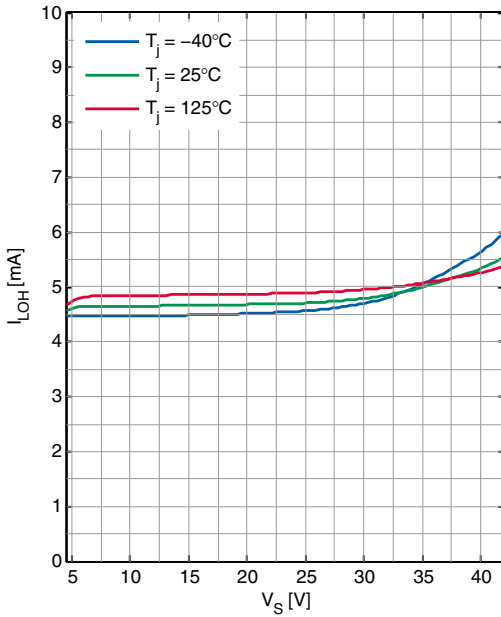

Open Load Current Threshold I_{LOH} versus Junction Temperature T_j

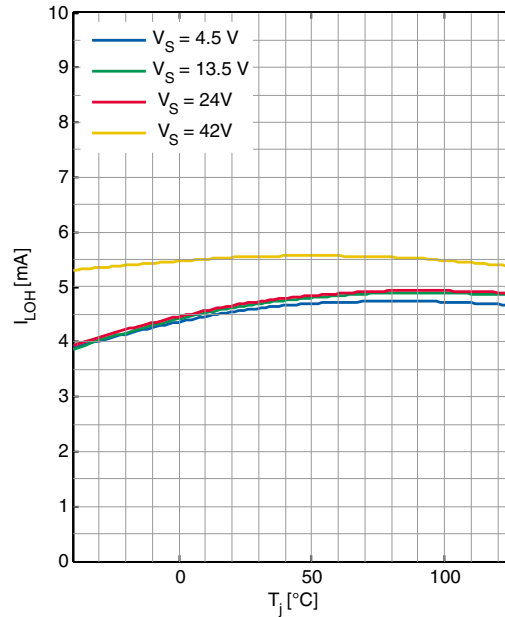

Open Load Current Threshold I_{LOL} versus Supply Voltage V_S

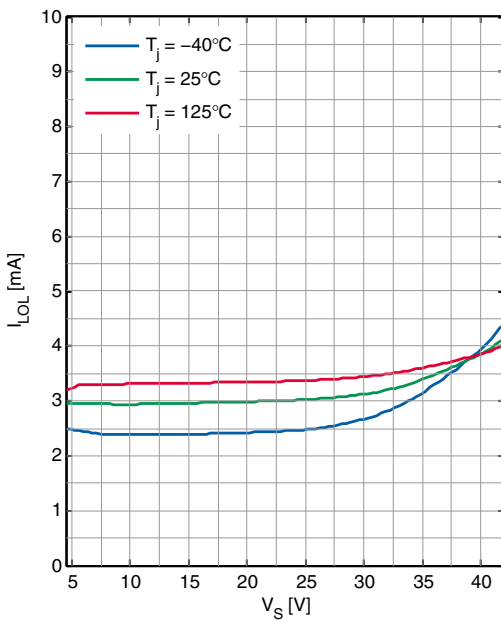

Open Load Current Threshold I_{LOL} versus Junction Temperature T_j

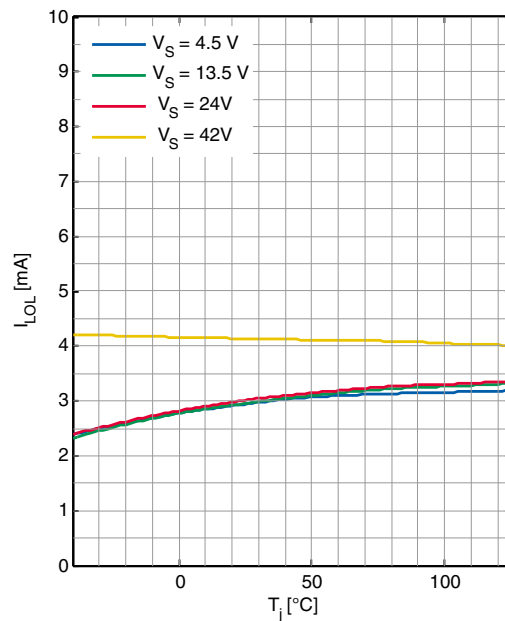

Typical Performance Characteristics

Freewheeling diode forward voltage V_F versus Current I_F

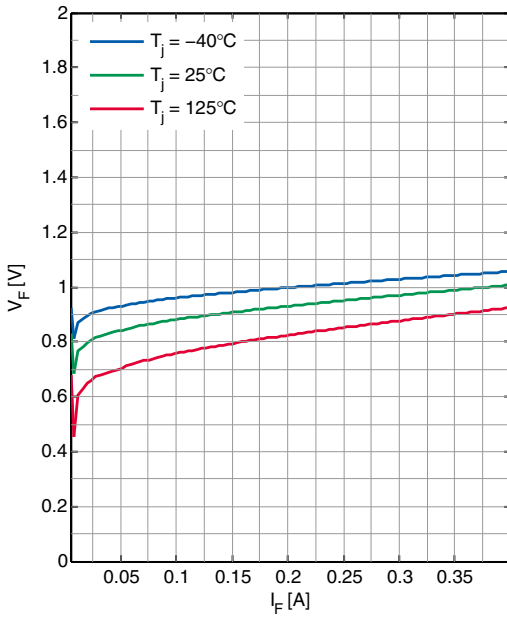

Freewheeling diode forward voltage V_F versus Junction Temperature T_j

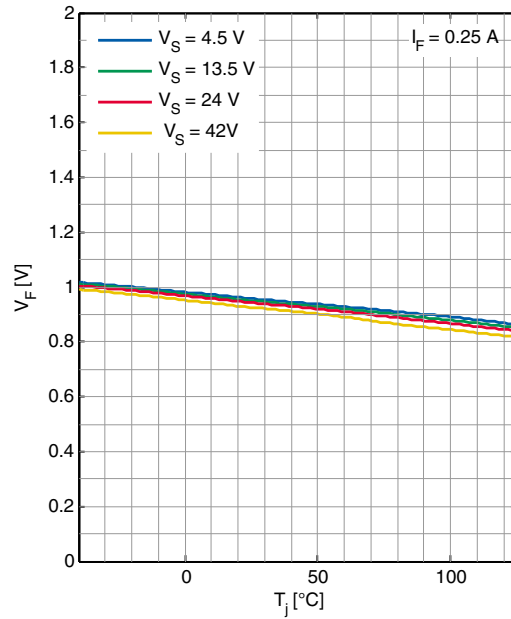

Output Current Limitation I_{OUTL} versus Junction Temperature T_j

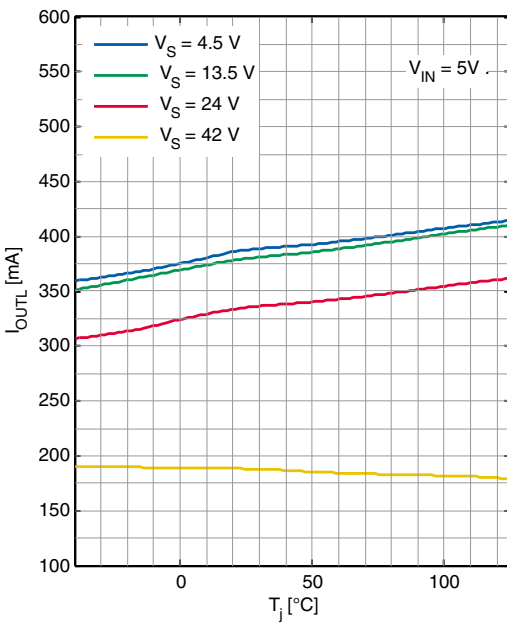

Output Current Limitation I_{OUTL} versus Supply Voltage V_S

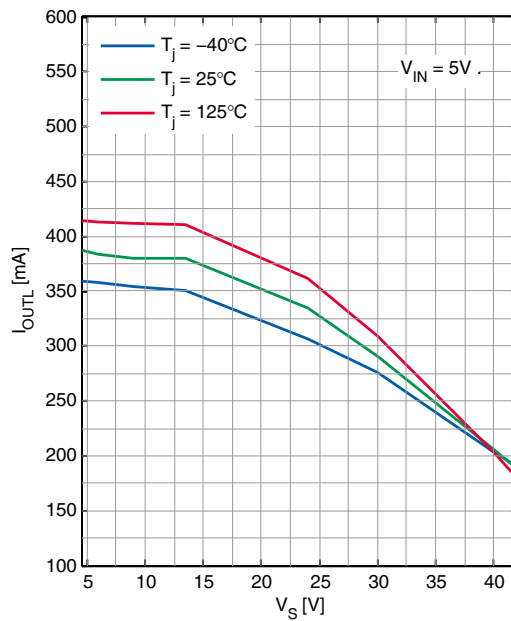

8 Application Information

Note: The following information is given as a hint for the implementation of the device only and shall not be regarded as a description or warranty of a certain functionality, condition or quality of the device.

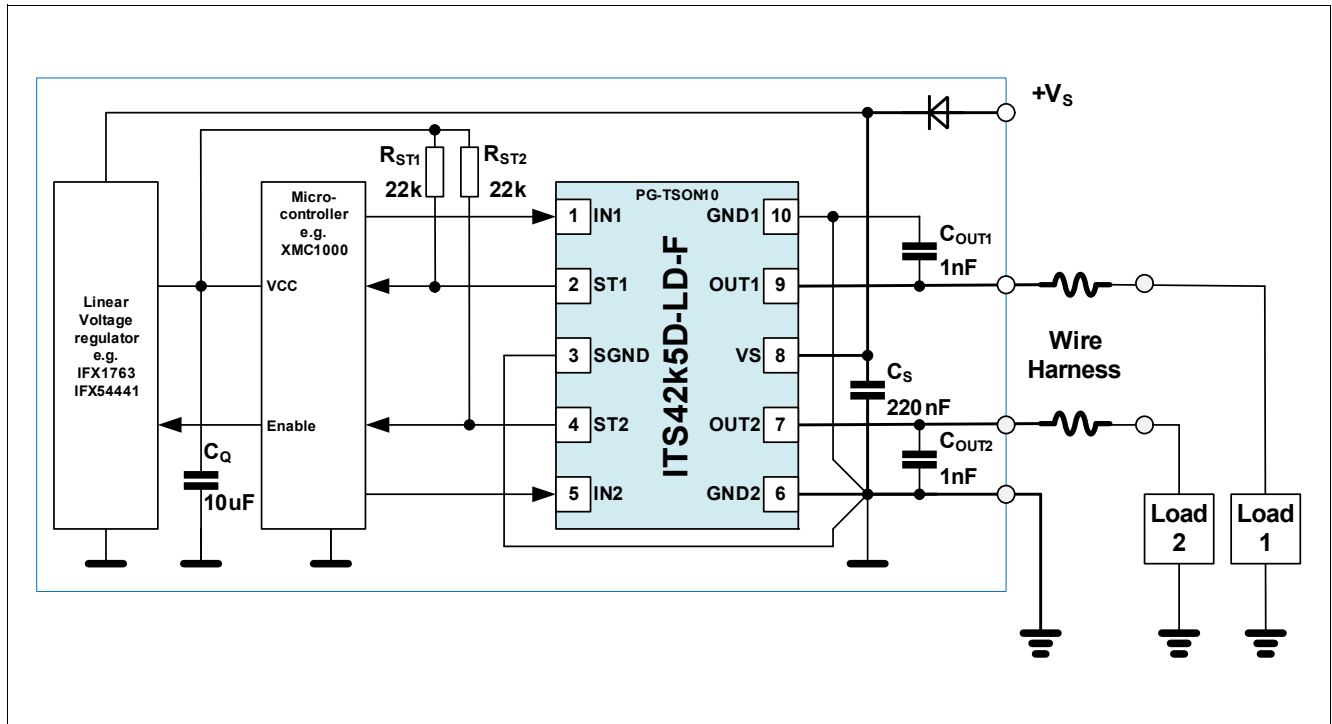

Figure 9 Application diagram ITS42k5D-LD-F

The ITS42k5D-LD-F can be connected via a reverse polarity diode to a supply network. It is recommended to place a ceramic capacitor (e.g. $C_s = 220\text{nF}$) between supply voltage VS and GND of the module to avoid line disturbances. Wire harness inductors/resistors are sketched in the application circuit above.

The complex loads (resistive, capacitive or inductive) must be connected to the output pins OUT1 and OUT2.

A built-in current limit protects the device against destruction.

The ITS42k5D-LD-F can be switched on and off with standard logic ground related logic signals at pin IN1 and IN2. In standby mode (IN1=IN2=L) the ITS42k5D-LD-F is deactivated with very low current consumption.

The output voltage slope is controlled during on and off transition to minimize emissions. Only a small ceramic capacitor $C_{OUT1,2} = 1\text{nF}$ is recommended to attenuate RF noise.

An evaluation board is available for the easy evaluation of the ITS42k5D-LD-F. Please refer to the Evaluation Board Finder under Tools on the Infineon webpage.

8.1 Thermal Considerations

The kind of PCB required for an application can be easily derived if the ambient temperature of the application, in which the ITS42k5D-LD-F is being used, is known.

Let us assume the following application conditions with both channels active:

$I_{OUT} = 250 \text{ mA}$ (Given by application, load dependent)

$R_{DSON,Max} = 8 \Omega$ (Worst case scenario considered)

$T_A = 60 \text{ }^\circ\text{C}$ (Ambient Temperature, given by application)

$T_{j,max} = 125^\circ\text{C}$ as given under **“Functional Range” on Page 13**

(1)

$$P_D = I_{OUT}^2 \times R_{DSON}$$

Applying the formula given above, one can calculate the power dissipation P_D in the application, which for our application scenario i.e. 0.5W for one channel active and 1W for both channels active.

Furthermore, we know that

(2)

$$R_{thJA, Max} = \frac{T_{j, max} - T_A}{P_D}$$

Hence we can calculate $R_{thJA,Max}$, which for this application scenario is 65K/W. As a result, the PCB design must ensure a thermal resistance of lower than 65K/W for the above mentioned application assumption. According to **“Thermal Resistance” on Page 13**, at least a 300mm² heatsink area is needed on a FR4 1s0p PCB or the FR4 2s2p board with thermal vias could be used for this application.

For support regarding thermal considerations, please contact us via our support webpage www.infineon.com/support.

For further support, please refer to application notes on the Infineon website www.infineon.com.

9 Package Outlines and Footprint

9.1 PG-TSON-10 Package Outline

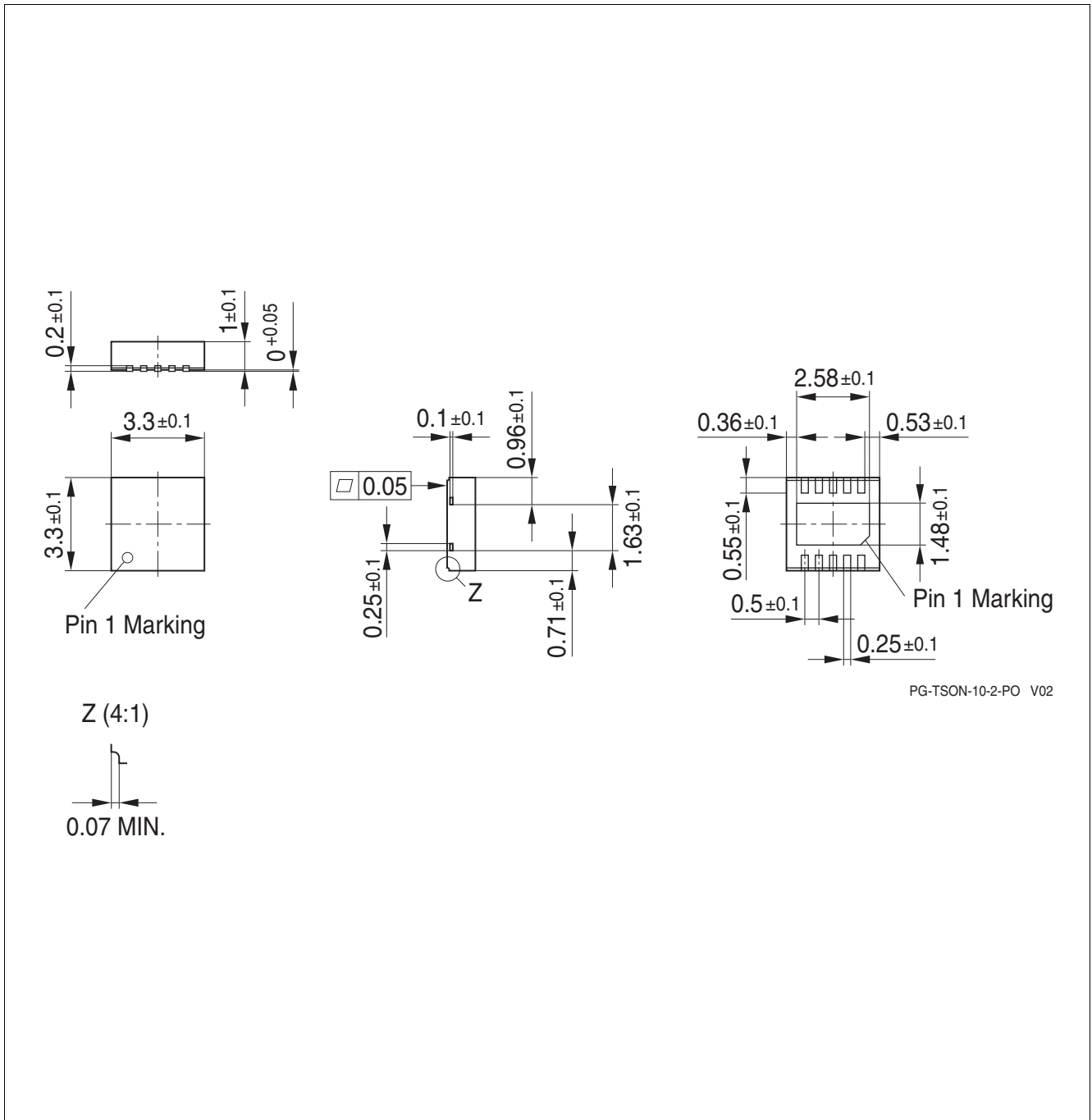

Figure 10 PG-TSON-10 (Plastic Dual Small Outline Package, RoHS-Compliant) Package Outline

9.2 PG-TSON-10 Footprint

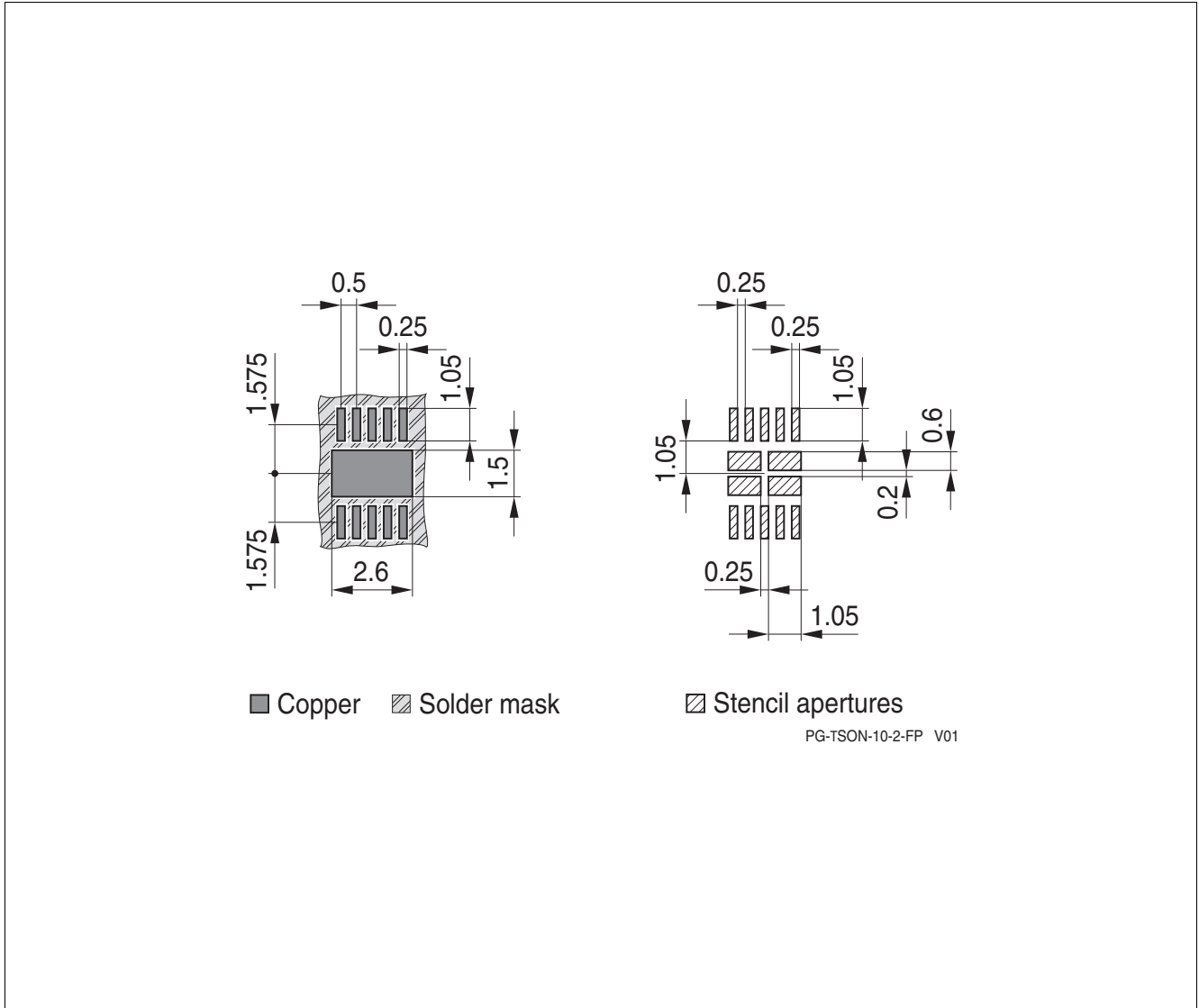

Figure 11 PG-TSON-10 (Plastic Dual Small Outline Package, RoHS-Compliant) Package Footprint

Green Product (RoHS compliant)

To meet the world-wide customer requirements for environmentally friendly products and to be compliant with government regulations the device is available as a green product. Green products are RoHS-Compliant (i.e Pb free finish on leads and suitable for Pb-free soldering according to IPC/JEDEC J-STD-020).

For further information on alternative packages, please visit our website:
<http://www.infineon.com/packages>.

Dimensions in mm

10 Revision History

Revision	Date	Changes
Rev 1.0	2015-04-28	Datasheet - Initial Version

Edition 2015-04-28

**Published by
Infineon Technologies AG
81726 Munich, Germany**

**© 2015-04-28 Infineon Technologies AG
All Rights Reserved.**

Legal Disclaimer

The information given in this document shall in no event be regarded as a guarantee of conditions or characteristics. With respect to any examples or hints given herein, any typical values stated herein and/or any information regarding the application of the device, Infineon Technologies hereby disclaims any and all warranties and liabilities of any kind, including without limitation, warranties of non-infringement of intellectual property rights of any third party.

Information

For further information on technology, delivery terms and conditions and prices, please contact the nearest Infineon Technologies Office (www.infineon.com).

Warnings

Due to technical requirements, components may contain dangerous substances. For information on the types in question, please contact the nearest Infineon Technologies Office.

The Infineon Technologies component described in this Data Sheet may be used in life-support devices or systems and/or automotive, aviation and aerospace applications or systems only with the express written approval of Infineon Technologies, if a failure of such components can reasonably be expected to cause the failure of that life-support automotive, aviation and aerospace device or system or to affect the safety or effectiveness of that device or system. Life support devices or systems are intended to be implanted in the human body or to support and/or maintain and sustain and/or protect human life. If they fail, it is reasonable to assume that the health of the user or other persons may be endangered.

X-ON Electronics

Largest Supplier of Electrical and Electronic Components

Click to view similar products for [Power Switch ICs - Power Distribution](#) category:

Click to view products by [Infineon](#) manufacturer:

Other Similar products are found below :

[TCK111G,LF\(S\)](#) [FPF1018](#) [DS1222](#) [TCK2065G,LF](#) [SZNCP3712ASNT3G](#) [MIC2033-05BYMT-T5](#) [MIC2033-12AYMT-T5](#) [MIC2033-05BYM6-T5](#) [SLG5NT1437VTR](#) [SZNCP3712ASNT1G](#) [DML1008LDS-7](#) [KTS1670EDA-TR](#) [KTS1640QGDV-TR](#) [KTS1641QGDV-TR](#) [U6513A](#) [MIC2012YM-TR](#) [MP5095GJ-P](#) [TPS2021IDRQ1](#) [TPS2104DBVR](#) [TPS22958NDGKR](#) [MIC2098-1YMT-TR](#) [MIC94062YMT TR](#) [MIC2015-1.2YM6 TR](#) [MIC2075-2YM](#) [MIC94068YML-TR](#) [SIP32461DB-T2-GE1](#) [NCP335FCT2G](#) [TCK105G,LF\(S\)](#) [AP2411S-13](#) [AP2151DSG-13](#) [AP2172MPG-13](#) [MIC94094YC6-TR](#) [MIC94093YC6-TR](#) [MIC94064YC6-TR](#) [MIC94061YMT-TR](#) [MIC2505-1YM](#) [MIC94085YFT-TR](#) [MIC94042YFL-TR](#) [MIC2005-1.2YM6-TR](#) [SIP32510DT-T1-GE3](#) [NCP333FCT2G](#) [BTS3050TFATMA1](#) [NCP331SNT1G](#) [TPS2092DR](#) [TPS2063DR](#) [MIC2008YML-TR](#) [MIC94084YFT-TR](#) [MIC2040-1YMM](#) [DIO1280WL12](#) [AP22814ASN-7](#)