

XC2000 series Board Manual, V.1.0, June 2007

# XC2000 Easy Kit

Board REV. V1.0

Microcontrollers



Never stop thinking.

Edition 2007-06

**Published by  
Infineon Technologies AG  
81726 München, Germany**

**© Infineon Technologies AG 2007.  
All Rights Reserved.**

#### **Legal Disclaimer**

The information given in this document shall in no event be regarded as a guarantee of conditions or characteristics ("Beschaffenhheitsgarantie"). With respect to any examples or hints given herein, any typical values stated herein and/or any information regarding the application of the device, Infineon Technologies hereby disclaims any and all warranties and liabilities of any kind, including without limitation warranties of non-infringement of intellectual property rights of any third party.

#### **Information**

For further information on technology, delivery terms and conditions and prices please contact your nearest Infineon Technologies Office ([www.infineon.com](http://www.infineon.com)).

#### **Warnings**

Due to technical requirements components may contain dangerous substances. For information on the types in question please contact your nearest Infineon Technologies Office.

Infineon Technologies Components may only be used in life-support devices or systems with the express written approval of Infineon Technologies, if a failure of such components can reasonably be expected to cause the failure of that life-support device or system, or to affect the safety or effectiveness of that device or system. Life support devices or systems are intended to be implanted in the human body, or to support and/or maintain and sustain and/or protect human life. If they fail, it is reasonable to assume that the health of the user or other persons may be endangered.

---

**XC2000 Easy Kit**

**Revision History:**            **2007-06**

V 1.0

---

Previous Version:

Page	Subjects (major changes since last revision)

**We Listen to Your Comments**

Any information within this document that you feel is wrong, unclear or missing at all?  
Your feedback will help us to continuously improve the quality of this document.

Please send your proposal (including a reference to this document) to:

[mcdocu.comments@infineon.com](mailto:mcdocu.comments@infineon.com)



<b>Table of Contents</b>		<b>Page</b>
<b>1</b>	<b>Introduction</b> .....	6
<b>2</b>	<b>Features of the XC2000 series Easy Kit Board</b> .....	7
2.1	Summary of Features .....	7
2.2	Block Diagram .....	8
2.3	Layout Overview .....	9
2.4	DIP Switch S102 .....	10
2.5	Easy Kit Power Supply concept .....	11
2.5.1	Power Supply via Power Plug .....	12
<b>3</b>	<b>Description of Connectors and Switches</b> .....	13
3.1	Switch S102 .....	13
3.2	Headers and Connectors .....	14
3.2.1	USB (P101) .....	14
3.2.2	CAN1/2 (X103) .....	14
3.2.3	LIN Header (X104) .....	14
3.2.4	OCDS Interface .....	15
3.2.5	LEDs .....	15
3.2.6	Power Headers (optional) .....	16
3.3	Pin Definition and Location .....	17
3.3.1	144 - Pinout .....	17
3.3.2	100 - Pinout .....	19
3.4	Zero Ohm Resistors .....	21
<b>4</b>	<b>Memory Models</b> .....	23
4.1	Internal Flash .....	23
4.2	Internal PRAM .....	24
<b>5</b>	<b>Getting Started</b> .....	25
5.1	Power Supply .....	26
5.2	OCDS Debugging Interface .....	27
5.3	USB Interface for UART support .....	27
5.4	MemTool .....	27
5.5	ASC Bootstrap .....	27
5.6	Start Memtool .....	28
5.7	Connect to the Target .....	29
5.8	Prepare Memtool for Programming .....	30
5.9	Program .....	30
5.10	Execution Mode .....	31
<b>6</b>	<b>Schematic</b> .....	32



## **1 Introduction**

The XC2000 is a new family of 16/32-bit microcontrollers based on the high-performance C166S V2 core. The C166S V2 core more than doubles the performance of the well established C166 core while still providing code compatibility.

Applications can be developed easily. The Evaluation Board is equipped with peripherals for connection to the environment. An On Board Wiggler allows easy access to all peripherals and the core. For programming of the embedded Flash, MEMTOOL is available.

The Evaluation Board allows the easy development of XC2000 family applications with the corresponding tools. Subsequently, the applications can be downloaded and can be tested with the several powerful debuggers.

For detailed technical information about the different derivatives please refer to the XC2000 family web pages on the Infineon Internet.

## **2 Features of the XC2000 series Easy Kit Board**

### **2.1 Summary of Features**

- Infineon's XC2000 Controller in TQFP144/100 Package
- High Speed CAN Transceivers, LIN Transceiver, USB to UART/JTAG bridge
- 8 Low Power Status LEDs
- Easy access to all pins
- 4-DIP switches for configuration
- On board USB to JTAG / UART interface
- Powered via USB

#### **Connectors**

The XC2000 Board offers a wide variety of connectors:

- USB connector for ASC/JTAG Interface
- 4 pin header for LIN Transceiver
- 16-pin header for JTAG interface (OCDS)
- 10pin (2x5) Header for CAN High Speed Transceiver (CAN1/CAN2)

#### **Components**

- Low-Drop Voltage Regulator TLE 4274
- Step Down Voltage Regulator TLE 6365G (optional)
- Four status LED's for Power / RESET / JTAG
- 2 x CAN-Transceiver TLE 6251
- LIN Transceiver TLE 7259
- FT2232 Dual USB to UART/JTAG interface
- SPI EEPROM 128 Kbit AT25128N
- 8 general purpose LEDs
- Potentiometer for ADC
- Reset switch

#### **Zero Ohm Bridges**

- Zero Ohm resistors give the flexibility to configure the systems functionality

**2.2 Block Diagram**

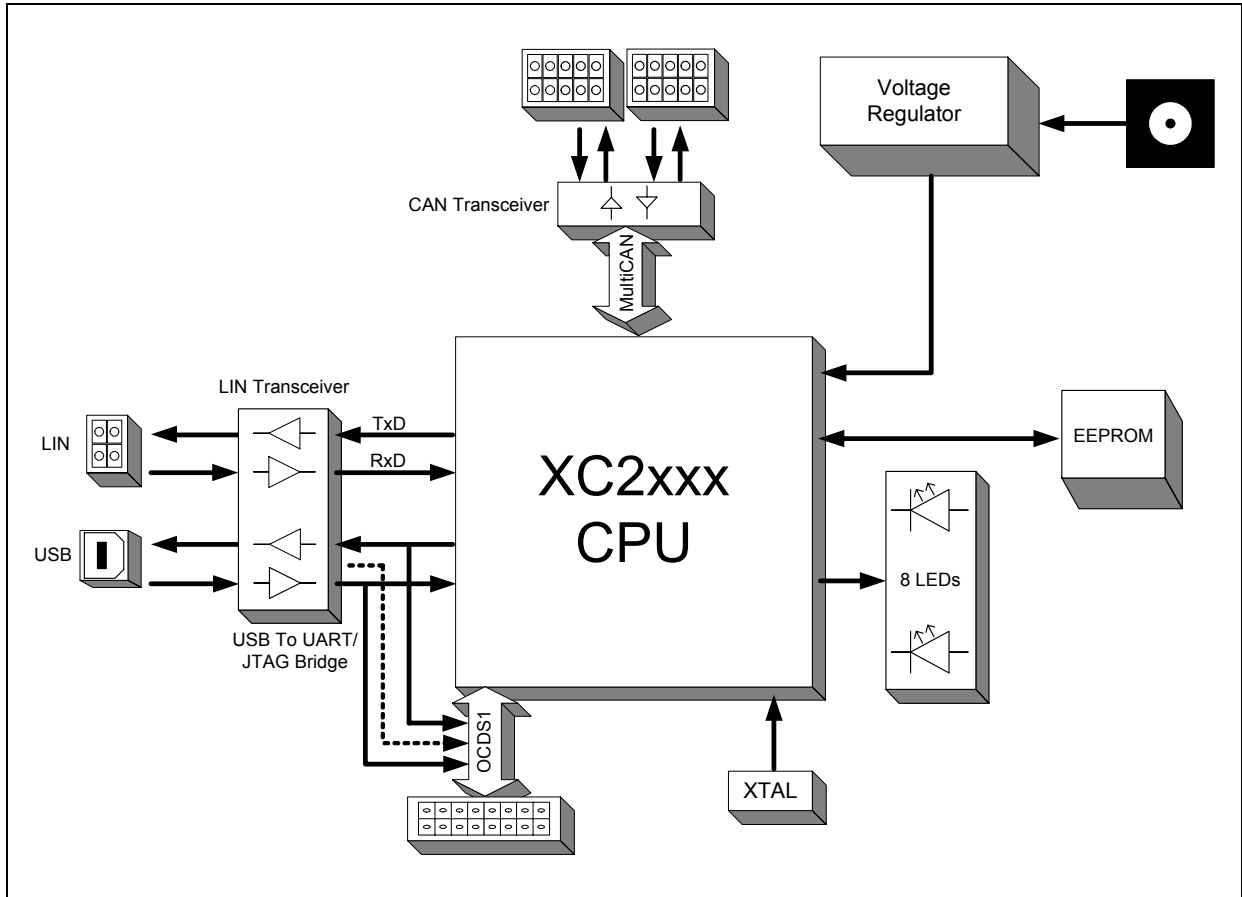
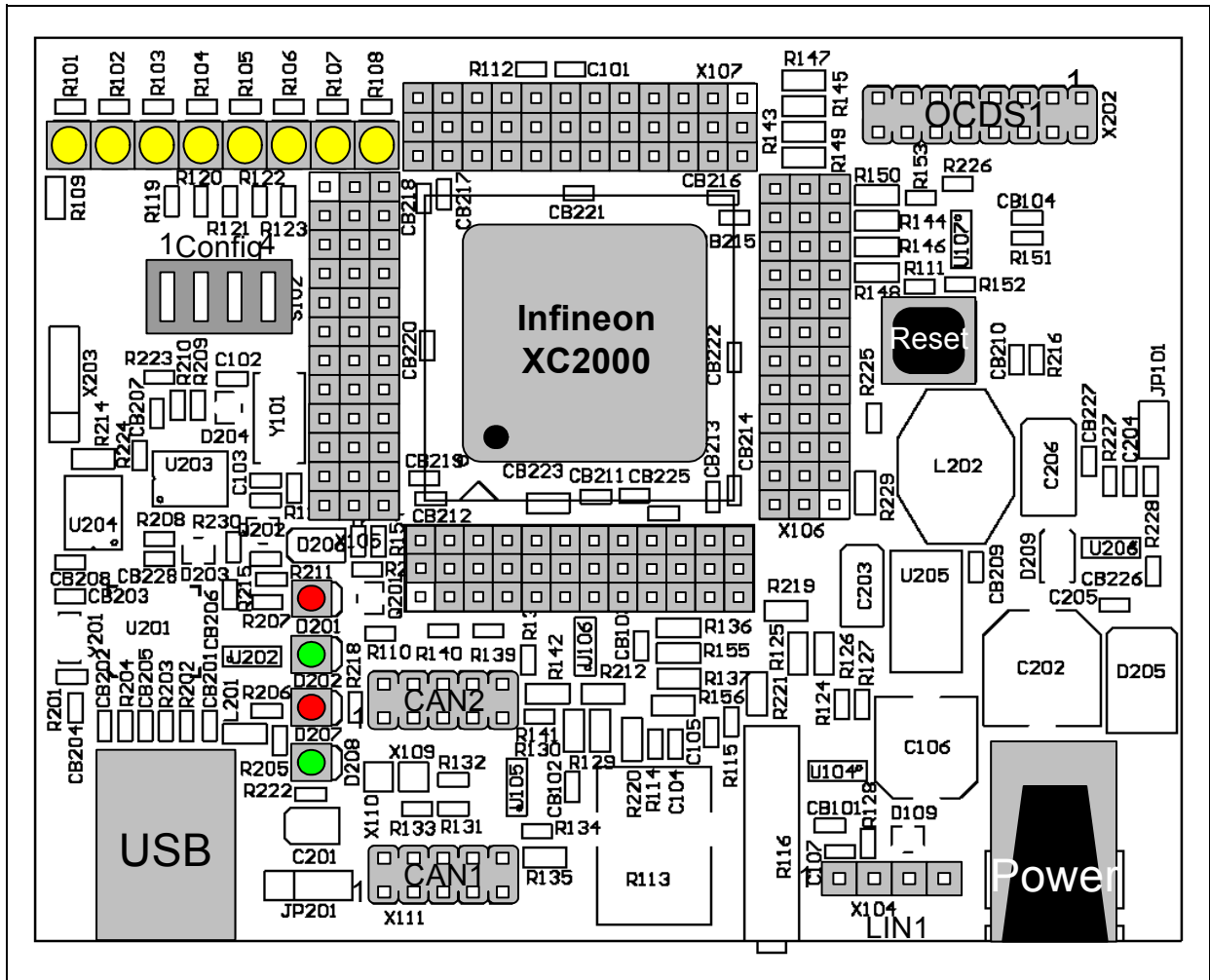

**Figure 1 Block diagram of XC2000 Easy Kit layout overview**



**Features of the XC2000 series Easy Kit Board**

**2.3 Layout Overview**



**Figure 2 Top View**

## 2.4 DIP Switch S102

Although most of the programmable features of the XC2000 are selected by software either during the initialization phase or repeatedly during program execution, some features must be selected earlier because they are used for the first access of the program execution.

These configurations are accomplished by latching the logic levels at a number of pins at the end of the internal reset sequence.

DIP switch S102 allows to configure the startup setting of the XC2000 during RESET. The default System Startup Configuration is shown in [Table 1](#). By default all DIP Switches are OFF. The XC2000 executes a standard start from internal Flash.

**Table 1 Default configuration**

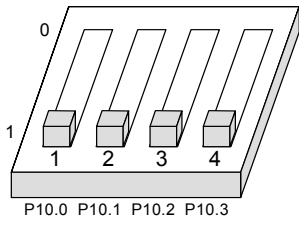
Name in schematic	Default configuration	Description
S102		Startup configuration: Standard start from internal Flash (Default)

**Table 2 Basic Startup Configuration via External Circuitry**

XC2xxx Pin level configured by S102	Function
P10.0 = 1, P10.1 = 1, P10.2 = P10.3 = X	Standard start internal Flash
P10.0 = 0, P10.1 = 1, P10.2 = 1, P10.3 = X	Bootstrap loader ASC0
P10.0 = 0, P10.1 = 1, P10.2 = 0, P10.3 = X	Enhanced bootstrap loader ASC0
P10.0 = 1, P10.1 = 0, P10.2 = 1, P10.3 = X	Bootstrap loader MultiCAN
P10.0 = 1, P10.1 = 0, P10.2 = 0, P10.3 = 1	Bootstrap loader SSC
All other positions	Reserved

For more detailed information about the DIP switch setting please refer to [Chapter 3.1](#), [Table 4](#).

## 2.5 Easy Kit Power Supply concept

The Easy Kit USB Power Supply concept enables the user to work with the Kit without an external Power Supply. If the USB power supply is not sufficient an additional regulated DC power supply can be used.

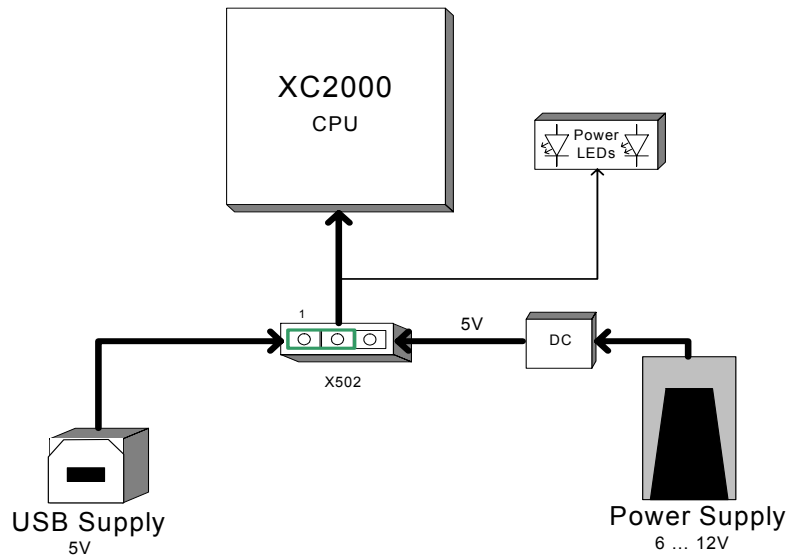

**Figure 3 Easy Kit Power Supply concept**

By means of the Power Supply Jumper X502, USB, or the external power Supply can be selected to run the Easy Kit. The Setup for the Jumper X502 is shown in [Table 3](#) below.

**Table 3 Power Supply Jumper configuration**

Name in schematic	Configuration	Description
X502		Power Supply via USB Interface <b>(Default)</b>
X502		Power Supply via Power Plug

**Figure 4 Power Supply via USB Interface**

## Features of the XC2000 series Easy Kit Board

The USB specification provides a 5 V supply on a single wire from which connected USB devices may draw power. The specification provides for no more than 5.25 V and no less than 4.35 V between the +ve and -ve bus power lines.

Initially, a device is only allowed to draw 100 mA. It may request more current from the upstream device in units of 100 mA up to a maximum of 500 mA. In practice, most ports will deliver the full 500 mA or more before shutting down power, even if the device hasn't requested it or even identified itself. If a (compliant) device requires more power than is available, then it cannot operate until the user changes the network (either by rearranging USB connections or by adding external power) to supply the required power.

*Note: If the USB power supply is not sufficient, an external power supply is needed and the Jumper X502 setting need to be changed.*

*Note: In case the USB Host PC goes into Suspend Mode, an external Power Supply should be used.*

### 2.5.1 Power Supply via Power Plug

The XC2000 Board can be supplied either with USB cable or with an external power supply. For external power supply a regulated DC power supply with **max. 12Volt/400mA** can be connected to the power connector. The maximum power dissipation of the used voltage regulator has to be taken into account.

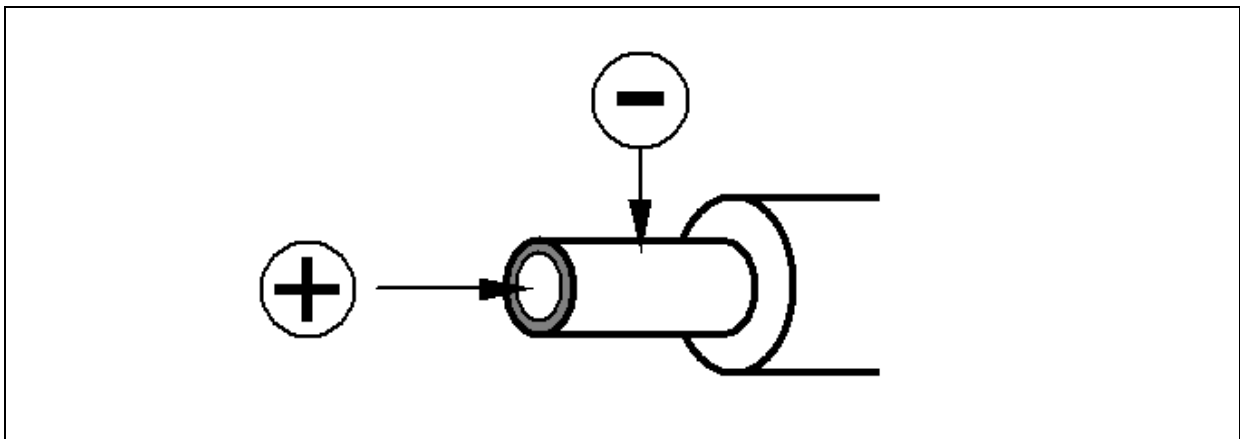

**Figure 5 Power Supply**

### 3 Description of Connectors and Switches

The On-Chip Bootstrap Loader allows the start code to be moved into the internal PSRAM of the XC2000 via the serial interface ASC0. The microcontroller will then execute the loaded start code out of the PSRAM.

#### 3.1 Switch S102

**Table 4 DIP Switch Settings for S102**

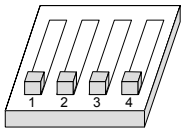
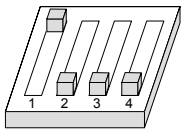
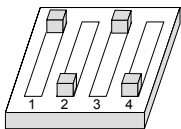
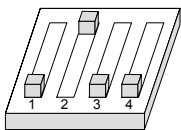
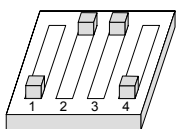
Name in schematic	Default configuration	Description
S102		Startup configuration: Standard start from internal Flash <b>OFF-OFF-OFF-OFF</b>
S102		Startup configuration: Bootstrap loader ASC <b>ON-OFF-OFF-OFF</b>
S102		Startup configuration: Enhanced bootstrap loader ASC <b>ON-OFF-ON-OFF</b>
S102		Startup configuration Bootstrap loader CAN <b>OFF-ON-OFF-OFF</b>
S102		Startup configuration Bootstrap loader SSC <b>OFF-ON-ON-OFF</b>
S102		Startup configuration All other positions are reserved

*Note: For debugging purpose (OCDS) the standard start from internal Flash configuration must be used.*

### 3.2 Headers and Connectors

#### 3.2.1 USB (P101)

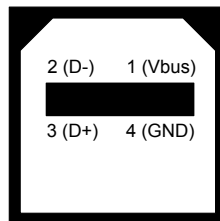

#### 3.2.2 CAN1/2 (X103)

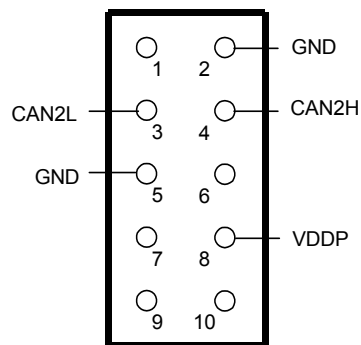

#### 3.2.3 LIN Header (X104)

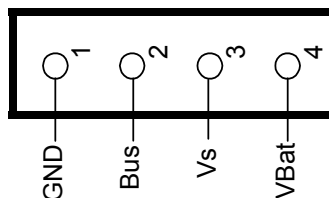

### 3.2.4 OCDS Interface

#### On-board header X102

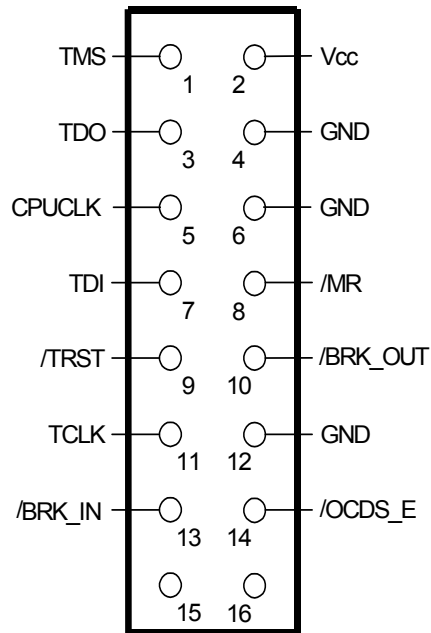

### 3.2.5 LEDs

**Table 5 LEDs description**

LED number	Description
D201	Debug Run Mode
D202	Debug Active
D207	Power On Reset Active
D208	Board Voltage 5 Volt
D105 - D112	Status of P10L

### 3.2.6 Power Headers (optional)

The power headers can be mounted if a power inverter board for an electrical motor drive application is used.

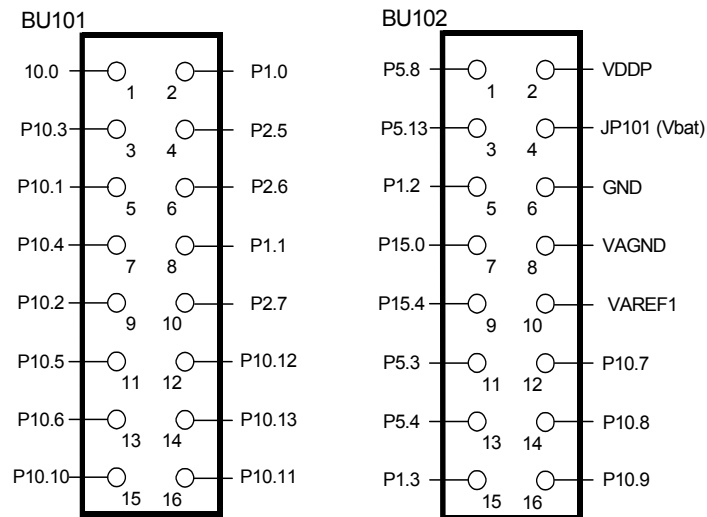



### 3.3 Pin Definition and Location

#### 3.3.1 144 - Pinout

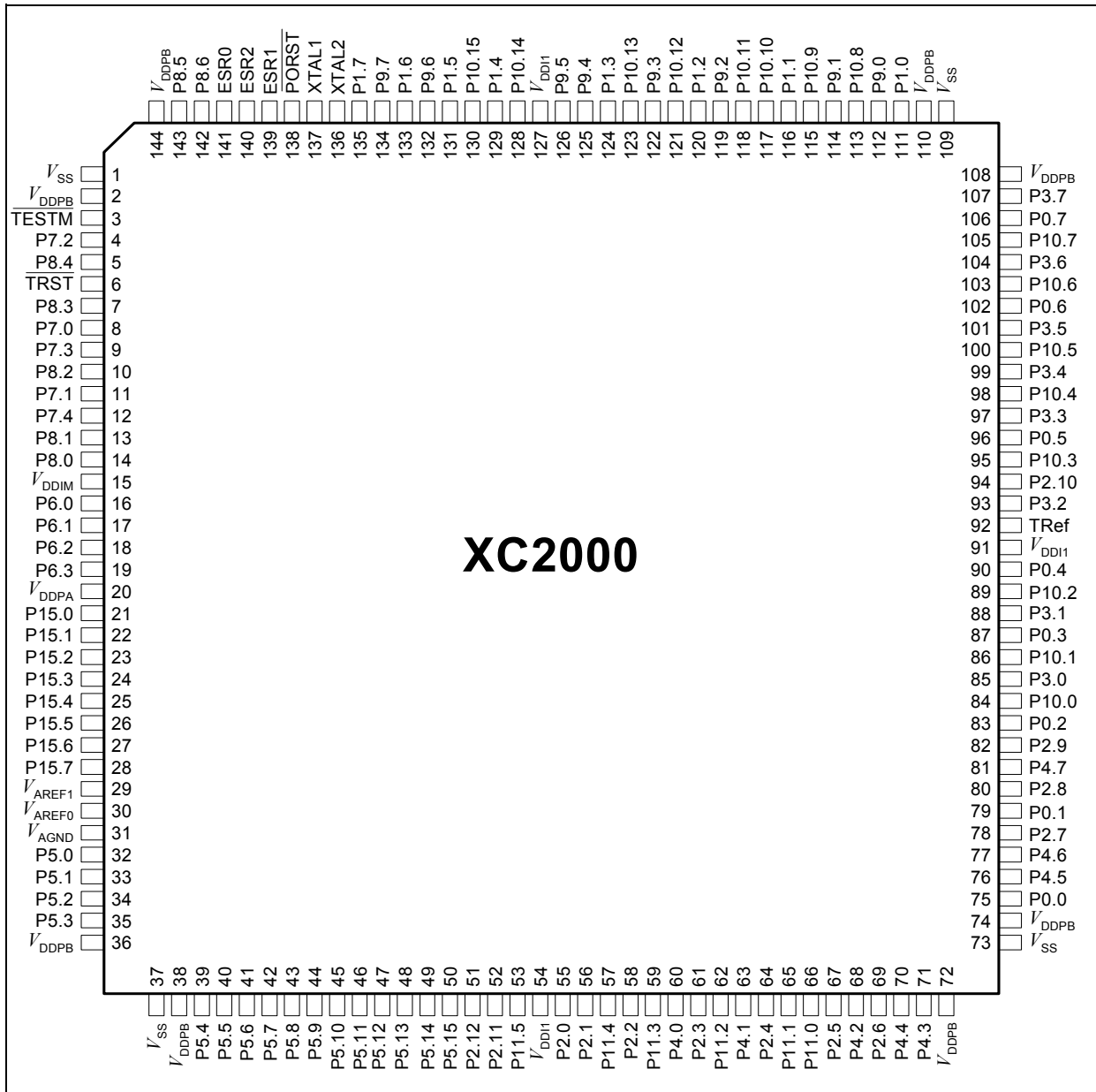

**Figure 6 Pinout of the 144 Pin device**

**Description of Connectors and Switches**

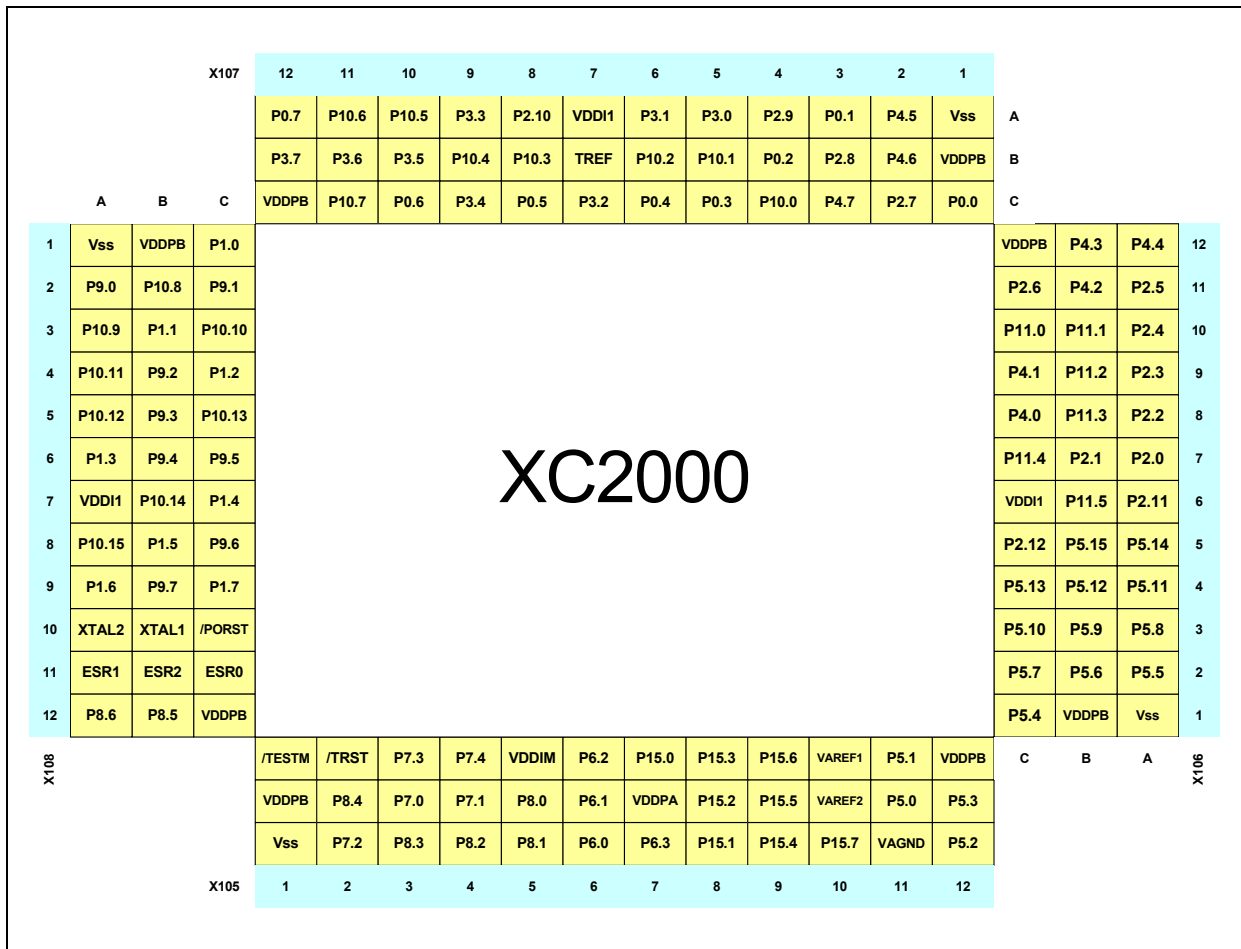

**Figure 7 Pin connector of the 144 pin device**

**3.3.2 100 - Pinout**

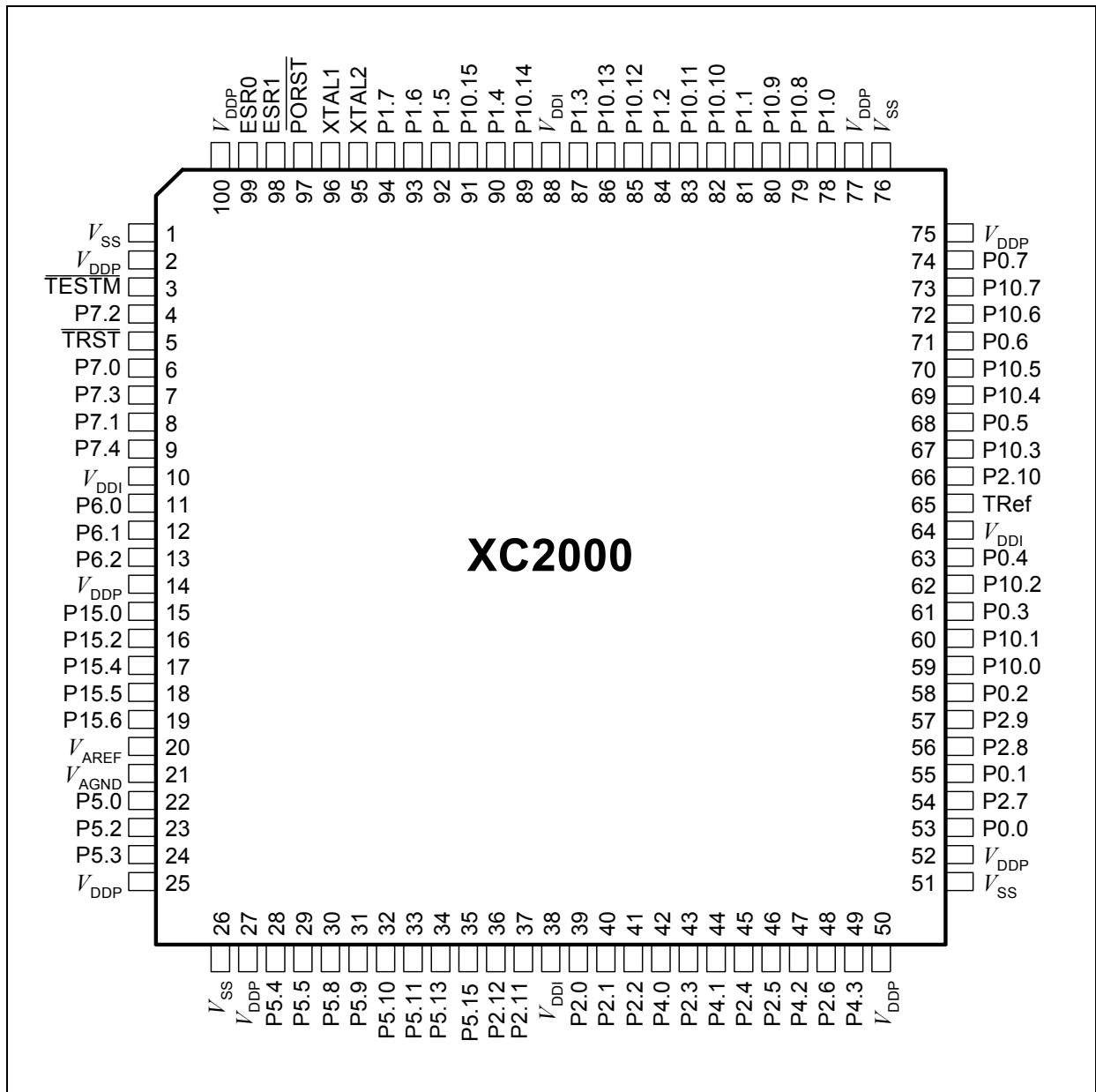

**Figure 8 Pinout of the 100 pin device**

**Description of Connectors and Switches**

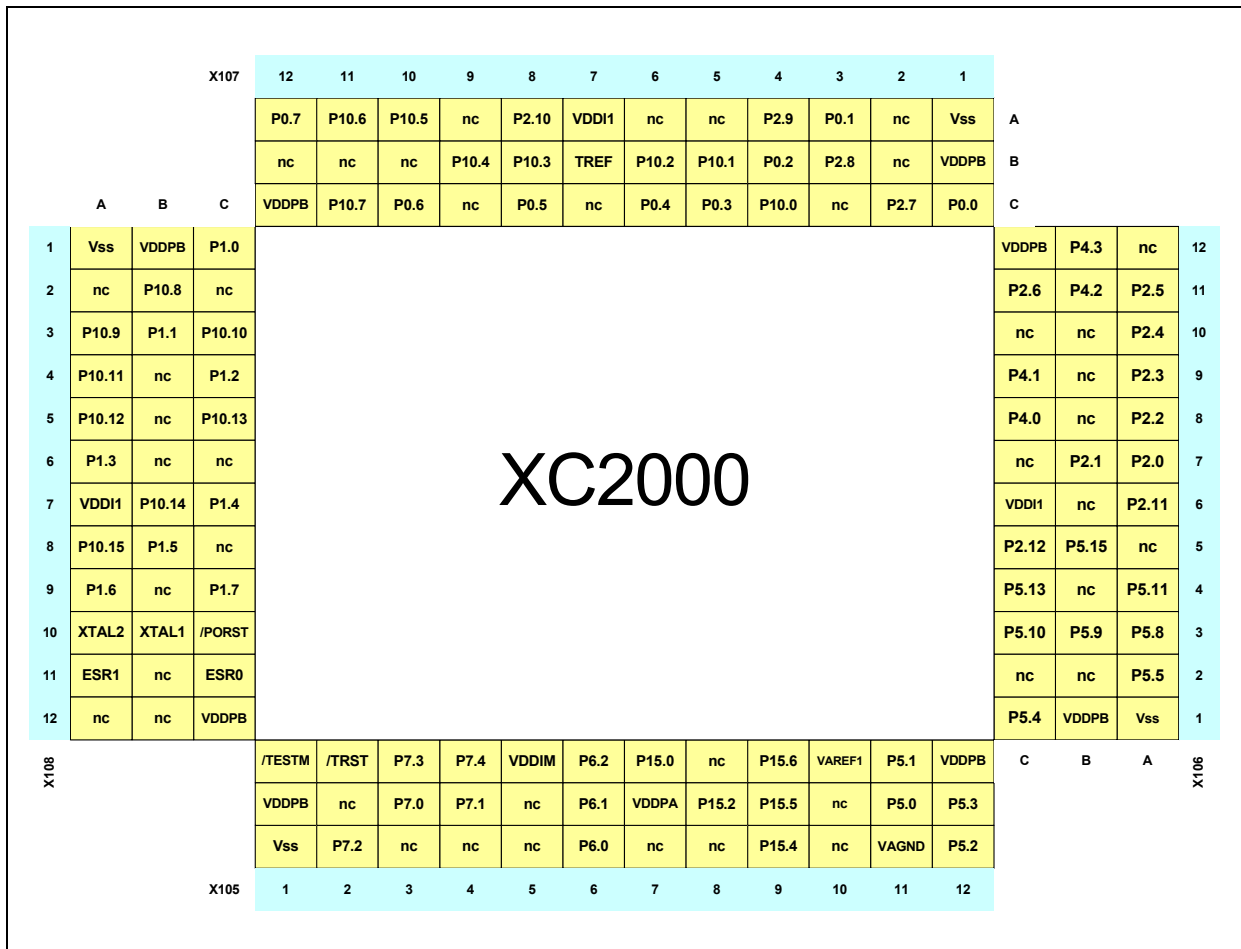

**Figure 9 Pin connector of the 100 pin device**

### 3.4 Zero Ohm Resistors

For configuration purposes several zero ohm resistors have been implemented. The functionality of these resistors are shown in the table below.

**Table 6 Zero Ohm Resistors**

Component	Name in schematic	Description
TLE 7259G (LIN Transceiver Board)	R124 R125 / R126	enable / disable connect / disconnect
TLE 6251DS (CAN Transceiver)	R129 / R130 R136 / R137 R155 / R156 R131 R138 R135 R142 R133 / 134 R140 / 141	connect / disconnect (CAN1) connect / disconnect (CAN2) or connect / disconnect (CAN2) enable / disable (CAN1) enable / disable (CAN2) supply Bus voltage internal / external (CAN1) supply Bus voltage internal / external (CAN2) connect Bus / disconnect Bus (CAN1) connect Bus / disconnect Bus (CAN2)
AT25128N (Serial EEPROM)	R143 / R145 R147 / R149 R144 / R146 R148 / R150	connect to USIC1 Channel1 connect to USIC1 Channel1 connect to SSC bootstrap loader (U0C0) connect to SSC bootstrap loader (U0C0)
FT2232D (USB to UART / JTAG Bridge)	R214  R224 R223 R214	connect / disconnect Receive RxD0  /BRKOUT (optional) /BRKIN (optional) connect / disconnect UART RxD
U203	R210	For internal use only
EEPROM 93LC46B	R207	If ORG functionality is needed
Microcontroller XC2xxx Analog reference	R220 / R221 R219	change of analog reference source
Voltage supply	R212 / R229	change of voltage supply

**Description of Connectors and Switches****Table 6      Zero Ohm Resistors**

<b>Component</b>	<b>Name in schematic</b>	<b>Description</b>
JTAG X202	R225 R226	/BRKIN (optional) /BRKOUT (optional)
Status LED's Oscillator circuit	R109 R117/R118	connect / disconnect LED's to 5 V oscillator gain

## 4 Memory Models

The memory space of the XC2000 is configured in a “Von Neumann” architecture. This means that code and data are accessed within the same linear address space.

Attached there are two examples for memory mapping of the XC2000 Board.

### 4.1 Internal Flash

As a example the XC2287-96F66L incorporates 768 Kbytes of embedded Flash memory (starting at location C0'0000<sub>H</sub>) for code or constant data. It is operated from the 5Volt pad supply and requires no additional programming voltage. The Flash memory consists of three independent flash modules. Each module is 256 Kbyte wide. Each Flash array is organized in 64 physical sectors of 4 Kbytes. It combines the advantages of very fast read accesses with protected but simple writing algorithms for programming and erasing. The 128-bit code read accesses from the Flash memory realize maximum CPU performance by fetching two double word instructions (or four single word instructions) in a single access cycle.

Data integrity is enhanced by an error correction code enabling dynamic correction of single bit errors. Additionally, special margin checks are provided to detect and correct problematic bits before they lead to actual malfunctions.

The On-chip programming can be done either with a utility program, so called “Memtool” or with several other Toolchains from our Tool vendors. Memtool is using the ASC bootstrap Loader. The latest version can be found on the Infineon website. Other tools use the OCDS interface.

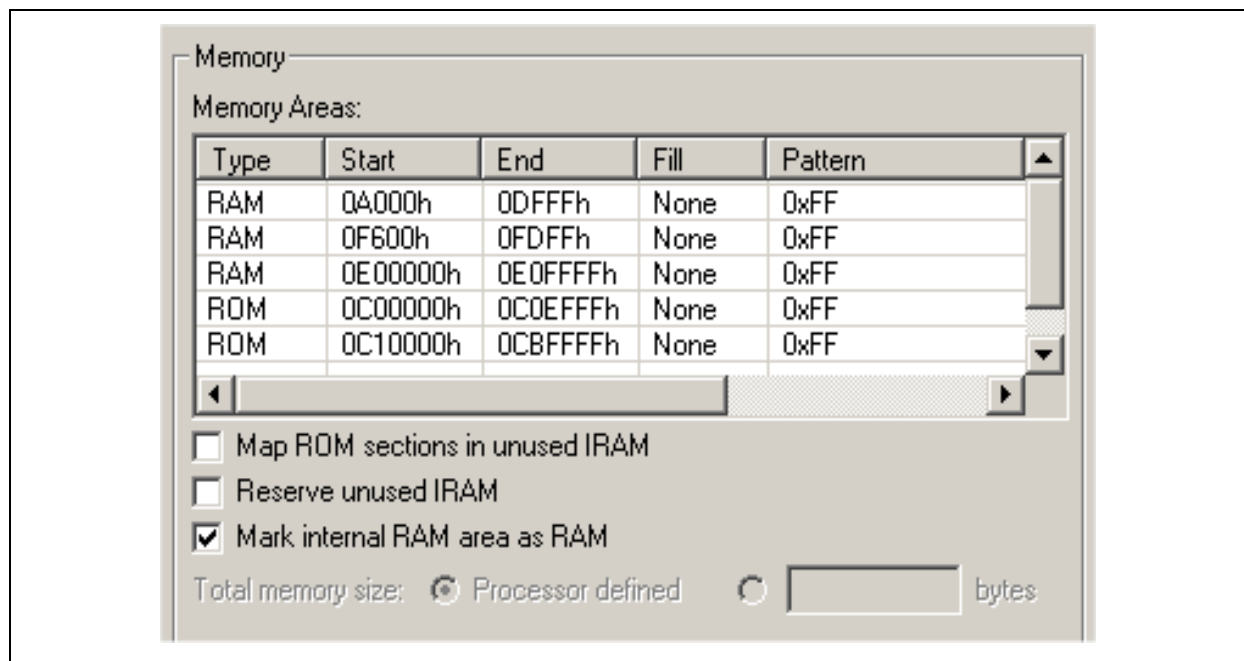

**Figure 10 Example for memory mapping (internal flash)**

## 4.2 Internal PRAM

As an example the XC2287-96F66L provides 64 Kbytes of PSRAM (E0'0000<sub>H</sub> ... E0'FFFF<sub>H</sub>). The PSRAM provides fast code execution without initial delays. Therefore, it supports non-sequential code execution, for example via the interrupt vector table.

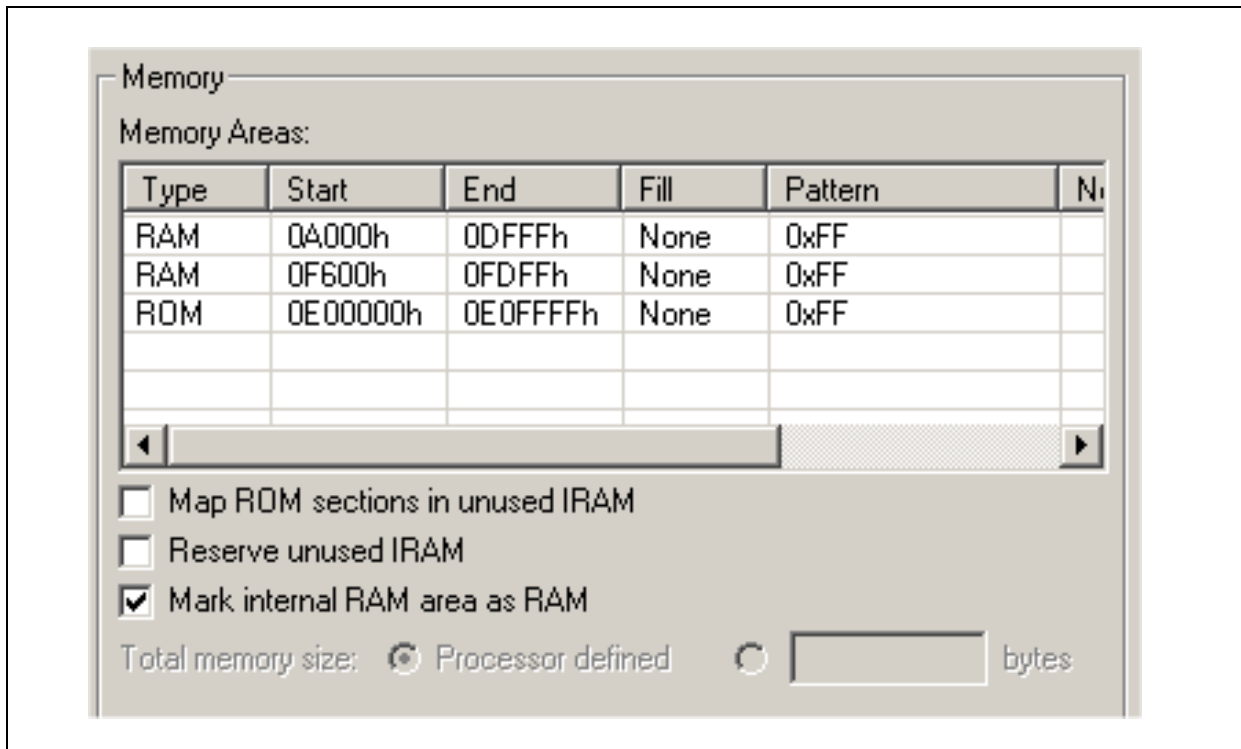

**Figure 11 Memory mapping for internal PRAM**



## 5 Getting Started

For the successful start up of the XC2000 Easy Kit, the following items should be done:



**Figure 12 XC2000 Easy Kit (144-Pin)**

By default a HELLO WORLD program can be executed. The following steps are needed to be successful.

1. Verify that the Jumper JP201 is in position 1-2 (powered via USB).
2. Connect USB cable with starterkit and PC.
3. Install DAS driver from starterkit CD.
4. Verify if the standard start mode is selected as described in chapter 3.1.
5. LED D105 connected with P10.0 should flash, otherwise press the Reset button.
6. Verify which COM port is activated for the FTDI - chip.
7. Execute the monitor program MTTY from the starterkit CD.
8. Select the corresponding COM port, 19200 Baud, none parity, 8 data Bit, one stop bit, parser off.
9. Start connection (File/connect).
10. Press Reset button on the starterkit, Hello World program is running .

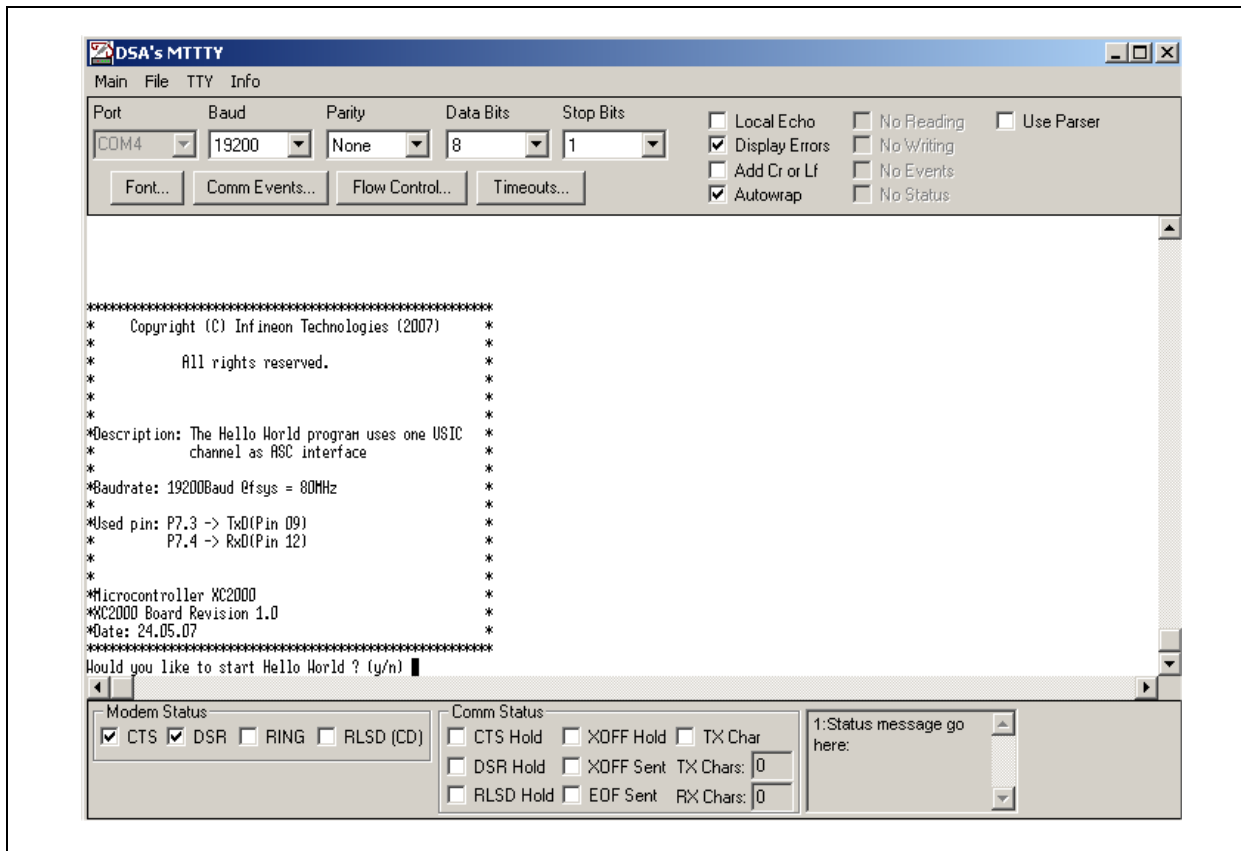
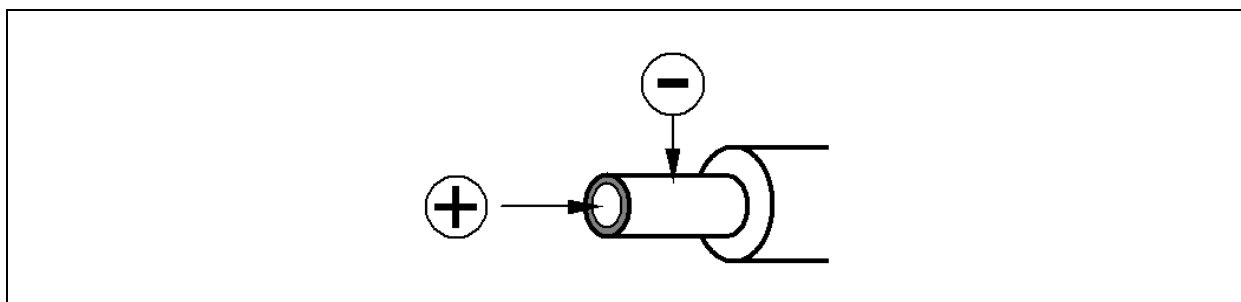

**Figure 13 Monitor Program MTTY with Hello World program**

## 5.1 Power Supply

If more current is needed, a regulated DC power supply with max. 12 Volts should be connected to the power connector. The maximum power dissipation of the used voltage regulator has to be taken into account. By default one green LED should be active. It indicates that the embedded voltage regulator supply the microcontroller.

**Please Note, the power supply is not part of the delivery !**



**Figure 14 Power Supply Connector**

## 5.2 OCDS Debugging Interface

The XC2000 Easy Kit offers two types of JTAG interfaces. With the FTDI chip an on board USB JTAG wiggler has been implemented. Further the USB interface allows to emulate a USB to UART bridge. Both can be done at the same time.

A simple 16 pin JTAG header can be used to connect a debugger from one of Infineon's tool suppliers. Both systems include an On-Chip Debug Support (OCDS) system, which provides convenient debugging, controlled directly by an external device via debug interface pins.

## 5.3 USB Interface for UART support

For flashing the program to the microcontroller a USB interface among the PC and the XC2000 board is needed. The on board FTDI device converts the USB protocol the ASC protocol.

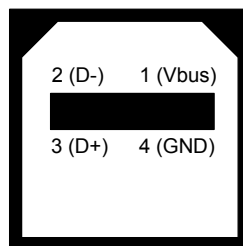

**Figure 15 USB Interface on the XC2000 board**

## 5.4 MemTool

Memtool is one of Infineon's solutions for programming code and data into FLASH Memory. Memtool supports on-chip FLASH Memory as well as dedicated Flash chips on the target board.

## 5.5 ASC Bootstrap

To establish the connection between the ASC bootstrap loader of the XC2000 microcontroller and the PC (MemTool) the bootstrap loader mode has to be configured.

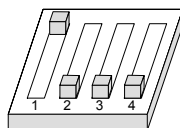

**Figure 16 ASC Bootstrap loader mode (DIP Switch S102)**

## 5.6 Start Memtool

Go to Target dialog (**Target/Change**) and select as a example 'Easy Kit with XC2287' from the list and Click 'ok'.

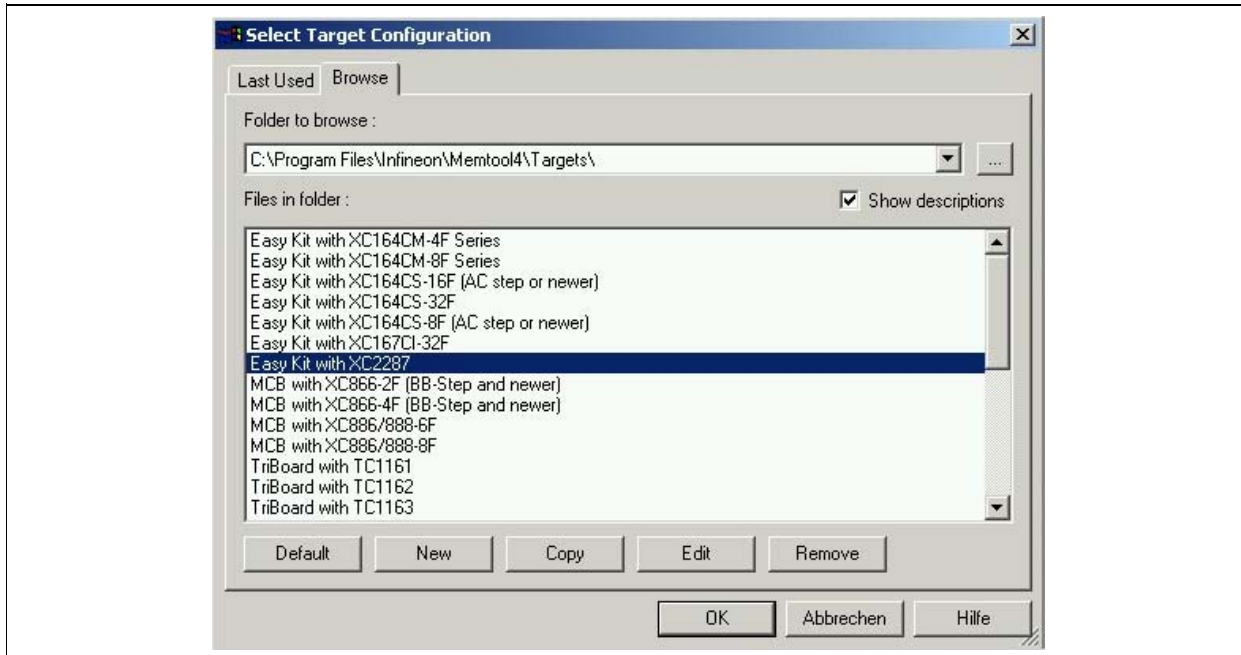
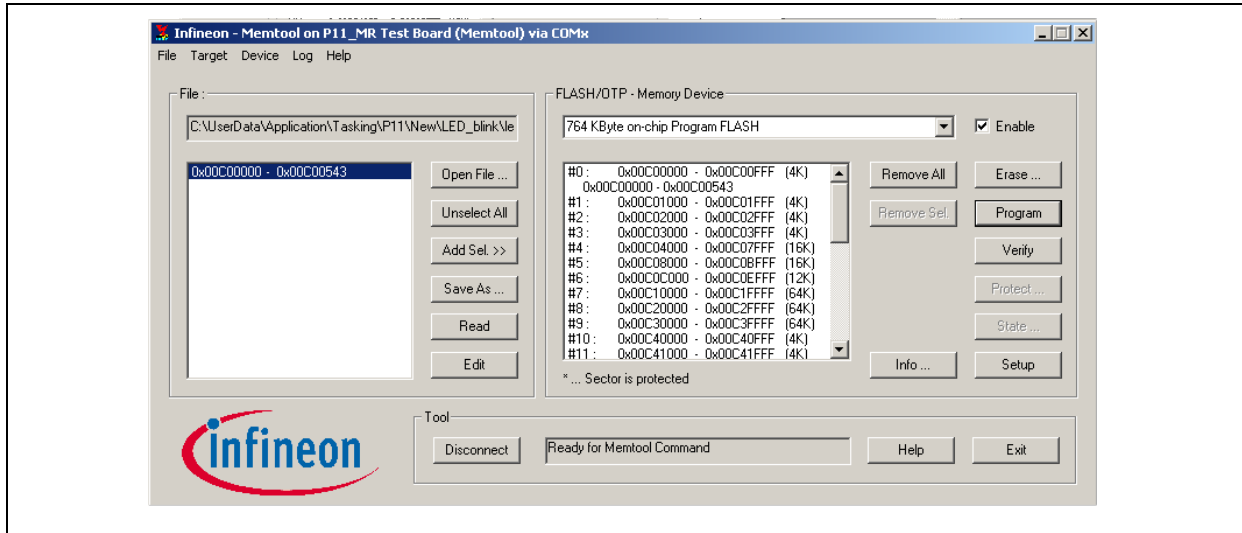

**Figure 17 Configuration of the Microcontroller Type**

## 5.7 Connect to the Target

Make sure that the Starter Kit board is connected to your PC as well as to your power supply. Hit the reset key on the starter kit. Now press the 'connect' button in Memtool.

If the software status bar displays 'Ready for Memtool Command', you have successfully installed Memtool.

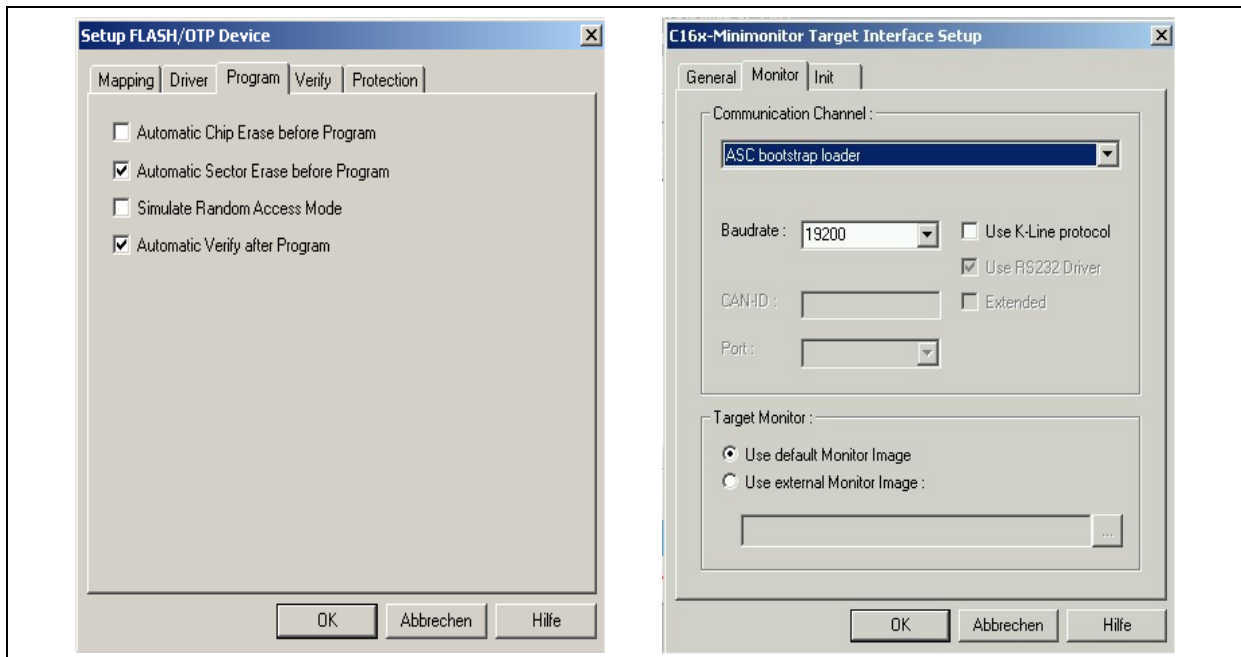

**Figure 18 Successful Connection**

## 5.8 Prepare Memtool for Programming

Check the setup for programming, select “Automatic Erase before Program” and “Automatic Verify after Program”.

Open the compiled hex file (\*.hex / \*.h86) from the project directory and push the “Select All” and “Add Sel.>>” Buttons



**Figure 19 Setup for Programming**

## 5.9 Program

Press the “Program” Button and check the result of the programming. After the successful program press “Disconnect Now”.

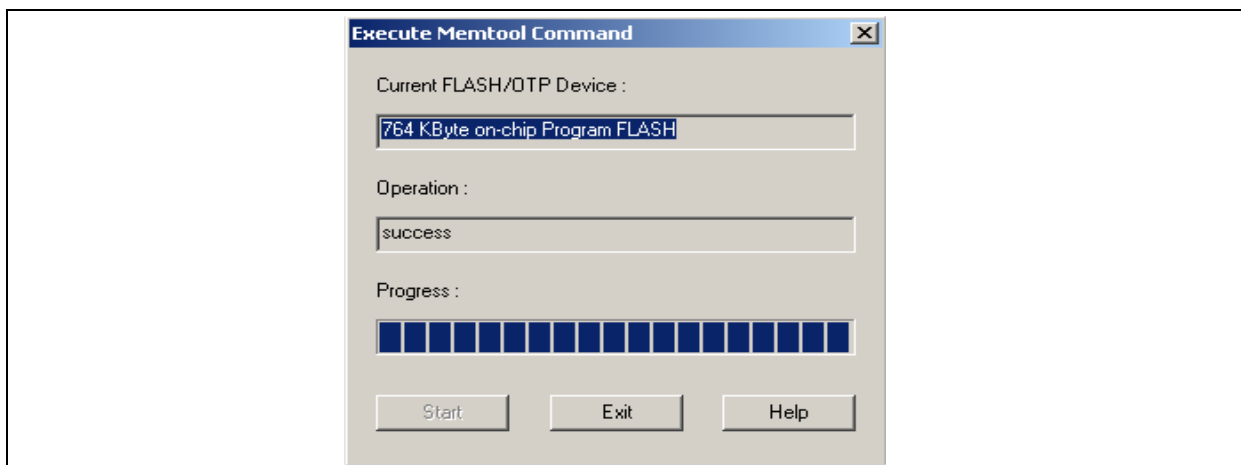

**Figure 20 Program**

## **5.10 Execution Mode**

After the code is programmed in the internal flash, the microcontroller has to be configured in the standard start mode.

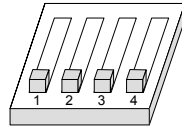

**Figure 21 Standard Start Mode (DIP Switch S102)**

After the reset button (blue) is pressed the program is executed from the internal flash.

**6 Schematic**

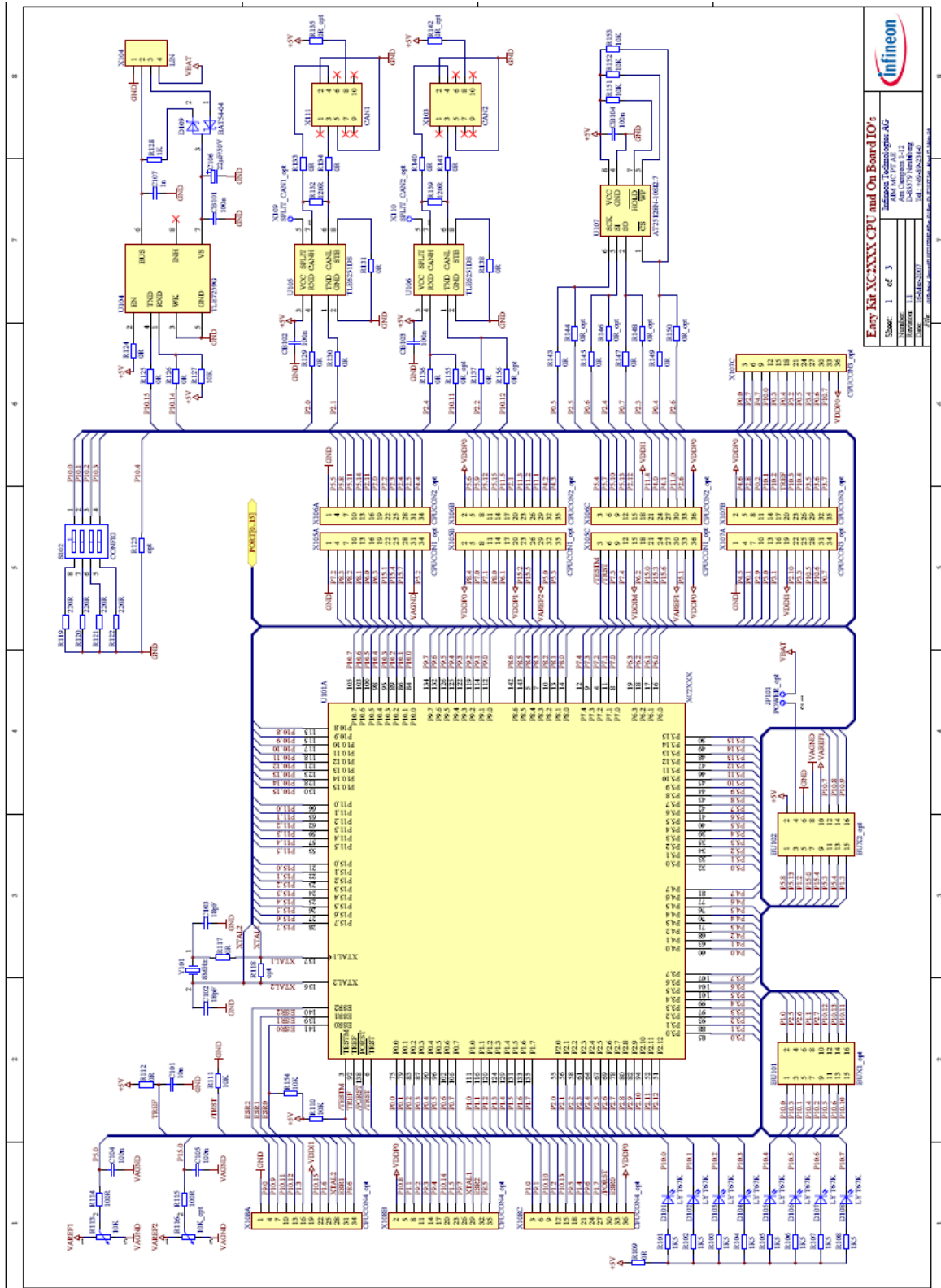

**Easy Kit XCXXX CPU and On Board IO's**  
 Infineon Technologies AG  
 Amberg-Weiden  
 D-93055 Weiden  
 Tel. +49 9352 21210







## X-ON Electronics

Largest Supplier of Electrical and Electronic Components

*Click to view similar products for [Development Boards & Kits - Other Processors](#) category:*

*Click to view products by [Infineon](#) manufacturer:*

Other Similar products are found below :

[EVB-MEC1418MECC](#) [20-101-1252](#) [CC-ACC-18M433](#) [STM8S/32-D/RAIS](#) [RTK0EN0001D01001BZ](#) [MAXQ622-KIT#](#)  
[YR0K50571MS000BE](#) [QB-R5F104PJ-TB](#) [CC-ACC-ETHMX](#) [OV-7604-C7-EVALUATION-BOARD](#) [SK-AD02-D62Q1747TB](#) [SK-BS01-D62Q1577TB](#) [ST7MDT1-EMU2](#) [GROVE BASE KIT FOR RASPBERRY PI](#) [CY8CKIT-143A](#) [RASPBERRY PI PICO](#) [EK-MPC5744P](#)  
[KITAURIXTC234TFTTOBO1](#) [ENW89854AXKF](#) [ENWF9201AVEF](#) [QB-R5F104LE-TB](#) [LV18F V6 64-80-PIN TQFP MCU CARD EMPTY](#)  
[LV-24-33 V6 44-PIN TQFP MCU CARD EMPTY](#) [LV-24-33 V6 64-PIN TQFP MCU CARD EMPTY](#) [LV-24-33 V6 80-PIN TQFP 1 MCU](#)  
[CARD EMPTY](#) [32X32 RGB LED MATRIX PANEL - 6MM PITCH](#) [3.3 - 5 VTRANSLATOR](#) [READY FOR XMEGA CASING \(WHITE\)](#)  
[RELAY4 BOARD](#) [ETHERNET CONNECTOR](#) [RFID CARD 125KHZ - TAG](#) [RFID READER](#) [RFM12B-DEMO](#) [MAROON](#) [3G CLICK](#)  
[\(FOR EUROPE AND AUSTRALIA\)](#) [MAX232](#) [MAX3232 BOARD](#) [ARTY S7-50](#) [TINKERKIT HALL SENSOR](#) [TOUCHPANEL](#)  
[TOUCHPANEL CONTROLLER](#) [MIKROBOARD FOR AVR WITH ATMEGA128](#) [MIKROBOARD FOR PSOC WITH CY8C27643](#)  
[MIKROBUS CAPE](#) [MIKRODRIVE](#) [MIKROETH 100 BOARD](#) [MIKROLAB FOR 8051 L](#) [MIKROPROG TO ST-LINK V2 ADAPTER](#)  
[BANANA PI GPIO EXTEND MODULE](#) [BATTERY BOOST SHIELD BOARD](#)