

# 15 W auxiliary SMPS for air conditioner using CoolSET™ ICE5AR4770BZS-1

REF\_5AR4770BZS-1\_15W1

## About this document

### Scope and purpose

This document is a reference design for a 15 W auxiliary SMPS for air conditioner with the latest CoolSET™ 5<sup>th</sup> Generation Fixed Frequency Plus ICE5AR4770BZS-1 switching controller from Infineon. The power supply is designed with a universal input compatible with most geographic regions and isolated output (+12 V/1.25 A) as typically used in most home appliances.

Highlights of the auxiliary power supply for air conditioners:

- High efficiency under light-load conditions to meet ENERGY STAR requirements
- Simplified circuitry with good integration of power and protection features
- Auto-restart protection scheme to minimize interruption and enhance user-friendly experience

### Intended audience

This document is intended for power supply design or application engineers, etc. who want to design auxiliary power supplies for air conditioners that are efficient under light-load conditions, reliable, and easy-to-design.

### CoolSET™

Infineon's CoolSET™ AC-DC integrated power stages in fixed-frequency switching scheme offers increased robustness and outstanding performance. This family offers superior energy efficiency, comprehensive protective features, and reduced system costs and is ideally suited for auxiliary power supply applications in a wide variety of potential applications such as:

- [SMPS](#)
- [Home appliances](#)
- [Server](#)
- [Telecom](#)

# 15 W auxiliary SMPS for air conditioner using CoolSET™

## ICE5AR4770BZS-1

REF\_5AR4770BZS-1\_15W1

### Table of contents

## Table of contents

<b>About this document</b> .....	<b>1</b>
<b>Table of contents</b> .....	<b>2</b>
<b>1 Introduction</b> .....	<b>4</b>
1.1 High efficiency under light-load conditions to meet ENERGY STAR requirements .....	5
1.2 Simplified circuitry with good integration of power and protection features.....	5
1.3 Auto-restart protection scheme to minimize interruption to enhance end-user experience.....	5
1.4 Document structure .....	5
<b>2 Reference design board</b> .....	<b>6</b>
<b>3 Power supply specifications</b> .....	<b>7</b>
<b>4 Schematic</b> .....	<b>8</b>
<b>5 Circuit description</b> .....	<b>9</b>
5.1 EMI filtering and line rectification.....	9
5.2 Flyback converter power stage.....	9
5.3 Control of flyback converter through CoolSET™ 5 <sup>th</sup> Generation Fixed Frequency Plus ICE5AR4770BZS-1 switching controller .....	9
5.3.1 Integrated HV power MOSFET .....	9
5.3.2 Current sensing (CS).....	9
5.3.3 Feedback and compensation network.....	10
5.4 Unique features .....	10
5.4.1 Fast self-start-up and sustaining of $V_{CC}$ .....	10
5.4.2 Frequency reduction control .....	10
5.4.3 Frequency jittering with modulated gate drive .....	11
5.4.4 System robustness and reliability through protection features .....	12
5.5 Clamper circuit .....	12
5.6 PCB design recommendations .....	13
<b>6 PCB layout</b> .....	<b>14</b>
6.1 Top side .....	14
6.2 Bottom side .....	15
<b>7 Bill of materials</b> .....	<b>16</b>
<b>8 Transformer specification</b> .....	<b>18</b>
<b>9 Measurement data and graphs</b> .....	<b>19</b>
9.1 Load regulation .....	20
9.2 Line regulation .....	21
9.3 Efficiency vs. AC-line input voltage.....	21
9.4 Standby power .....	23
9.5 Maximum output current.....	23
<b>10 Thermal measurement</b> .....	<b>24</b>
<b>11 Waveforms</b> .....	<b>25</b>
11.1 Start-up at low/high AC-line input voltage with maximum load.....	25
11.2 Soft-start.....	25
11.3 Switching waveform at maximum load.....	27
11.4 Frequency jittering and modulated gate drive .....	28
11.5 Output ripple voltage at maximum load .....	28
11.6 Output ripple voltage in ABM 1W load.....	29

# 15 W auxiliary SMPS for air conditioner using CoolSET™

## ICE5AR4770BZS-1

REF\_5AR4770BZS-1\_15W1

### Table of contents

11.7	Load transient response (dynamic load from 10–100 percent) .....	29
11.8	Detection of ABM level .....	30
11.9	Entering ABM .....	30
11.10	During ABM .....	31
11.11	Leaving ABM .....	31
11.12	Output overvoltage by utilizing $V_{CC}$ OVP .....	32
11.13	$V_{CC}$ undervoltage (auto restart) .....	32
11.14	Over-load protection.....	33
<b>12</b>	<b>Conducted emissions (EN 55022 Class-B) .....</b>	<b>34</b>
<b>13</b>	<b>ESD immunity (EN 61000-4-2) .....</b>	<b>37</b>
<b>14</b>	<b>Surge immunity (EN 61000-4-5) .....</b>	<b>38</b>
<b>15</b>	<b>Appendix A: WE transformer specification.....</b>	<b>39</b>
	<b>References.....</b>	<b>40</b>
	<b>Design support .....</b>	<b>41</b>
	<b>Revision history.....</b>	<b>42</b>
	<b>Disclaimer.....</b>	<b>43</b>

# 15 W auxiliary SMPS for air conditioner using CoolSET™ ICE5AR4770BZS-1

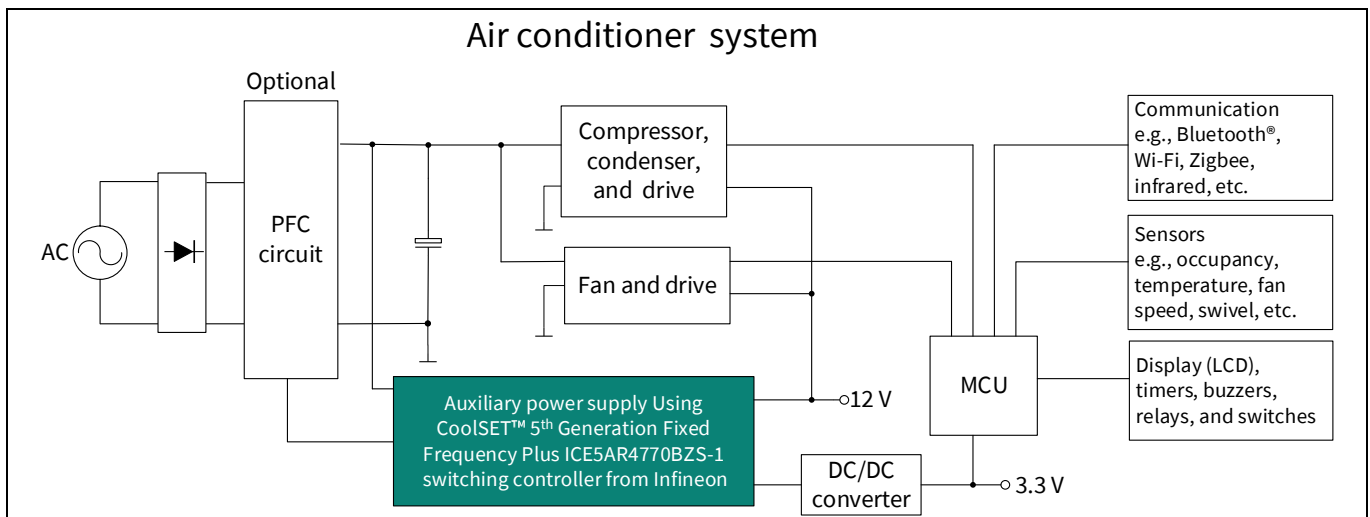
REF\_5AR4770BZS-1\_15W1

## Introduction

### 1 Introduction

With the growing household trend for smart devices, the new generation of home appliances such as air conditioners are equipped with advanced features such as wireless control and monitoring capability, smart sensors, and touchscreen displays; transforming a static product into an interactive and intelligent home appliance, capable of adapting to the smart-home theme. To support this trend, Infineon has introduced the latest CoolSET™ 5<sup>th</sup> Generation Fixed Frequency Plus to address this need in an efficient and cost-effective manner.

An auxiliary SMPS is needed to power the various modules and sensors, which typically operate from a stable DC voltage source. The CoolSET™ switching controller (as shown in [Figure 1](#)) from Infineon forms the heart of the system, providing the necessary protection and AC-DC conversion from the mains to multiple regulated DC voltages to power the various blocks.



**Figure 1** Simplified air conditioner system block diagram

[Table 1](#) lists the system requirements for an air conditioner and the corresponding Infineon solution is shown in the right column.

**Table 1** System requirements and Infineon solutions

No.	System requirement for air conditioner	Infineon solution – ICE5AR4770BZS-1
1	High efficiency under light-load conditions to meet ENERGY STAR requirements	New fixed-frequency control and Active Burst Mode (ABM)
2	Simplified circuitry with good integration of power and protection features	Embedded 700 V MOSFET and controller in DIP-7 package
3	Auto-restart protection scheme to minimize interruption to enhance end-user experience	All fault protections are in auto restart

**Introduction**

**1.1 High efficiency under light-load conditions to meet ENERGY STAR requirements**

During typical air conditioner operation, the power requirement fluctuates according to various use cases. However, in most cases where room temperature is already stabilized, the air conditioner will reside in an idle state in which the loading toward the auxiliary power supply is low. It is crucial that the auxiliary power supply operates as efficiently as possible, because it will be in this particular state for most of the period. Under light-load conditions, losses incurred with the power switch are usually dominated by the switching operation. The choice of switching scheme and frequency plays a crucial role in ensuring high conversion efficiency.

In this reference design, ICE5AR4770BZS-1 is primarily chosen because of its frequency reduction switching scheme. Compared with a traditional fixed-frequency flyback, the CoolSET™ switching controller reduces its switching frequency from medium to light load, minimizing the switching losses. Therefore, an efficiency of more than 80 percent is achievable at 25 percent load conditions.

**1.2 Simplified circuitry with good integration of power and protection features**

To relieve the designer of the complexity of PCB layout and circuit design, CoolSET™ switching controller is a highly integrated device with both a controller and high voltage (HV) MOSFET integrated into a single and space-saving DIP-7 package. These certainly help the designer to reduce component count as well as simplifying the layout into a single-layer PCB design for ease of manufacturing, using the traditional cost-effective wave-soldering process.

**1.3 Auto-restart protection scheme to minimize interruption to enhance end-user experience**

For an air conditioner, it would be annoying to both the end user and the manufacturer if the system were to halt and latch after protection. To minimize interruption, the CoolSET™ switching controller implements an auto-restart mode for all fault modes.

**1.4 Document structure**

This document provides complete design details including specifications, schematics, bill of materials (BOM), PCB layout, and transformer design and construction information. This information includes performance results pertaining to line/load regulation, efficiency, transient load, thermal conditions, conducted EMI scans, etc.

# 15 W auxiliary SMPS for air conditioner using CoolSET™ ICE5AR4770BZS-1

REF\_5AR4770BZS-1\_15W1

Reference design board

## 2 Reference design board

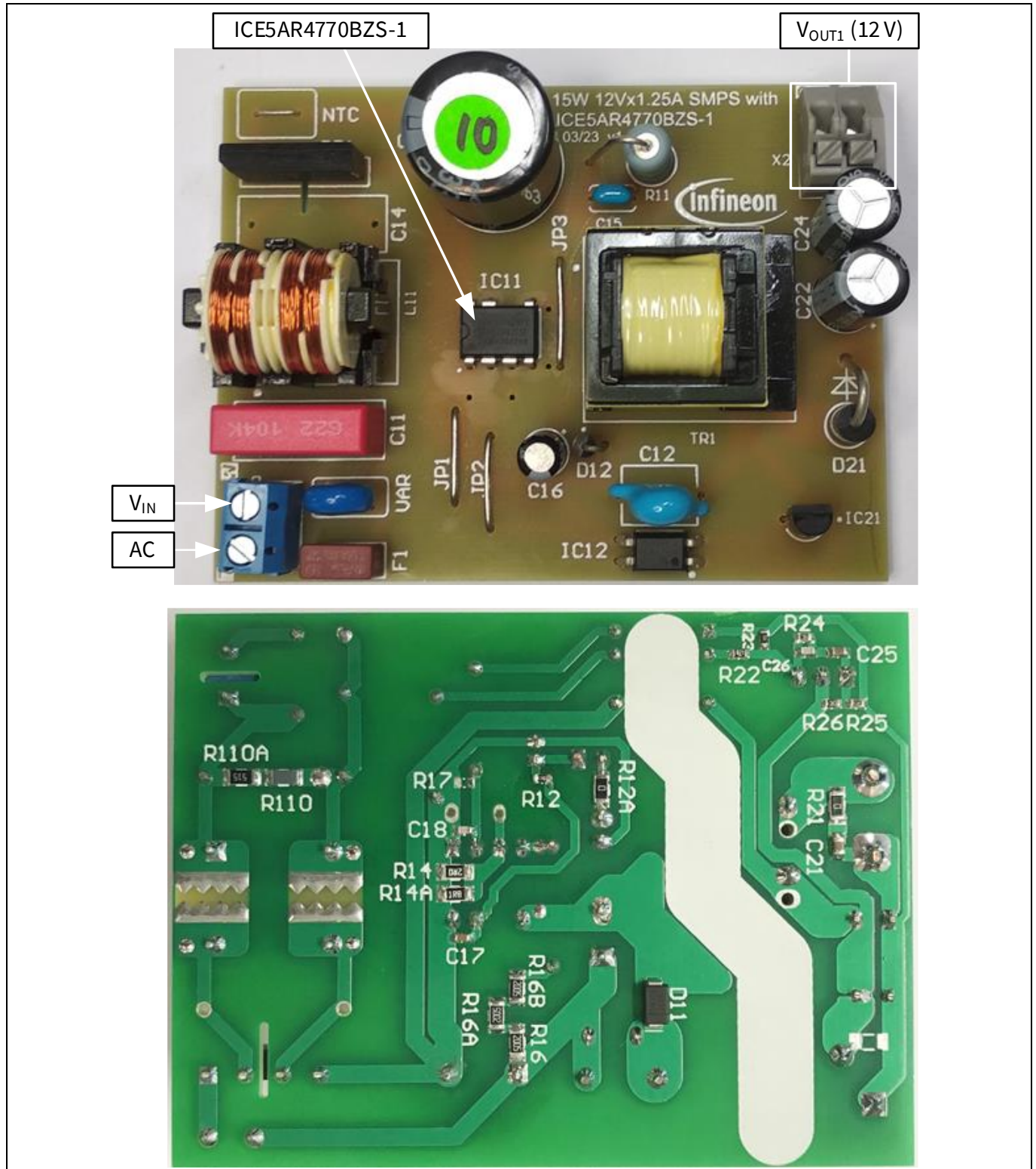


Figure 2 REF\_5AR4770BZS-1\_15W1

# 15 W auxiliary SMPS for air conditioner using CoolSET™

## ICE5AR4770BZS-1



REF\_5AR4770BZS-1\_15W1

Power supply specifications

### 3 Power supply specifications

The following table represents the minimum acceptance performance of the design. Actual performance is listed in the measurements section.

**Table 2** REF\_5AR4770BZS-1\_15W1 specifications

Description	Symbol	Min.	Typ.	Max.	Unit	Note/conditions
<b>Input</b>						
Voltage	$V_{IN}$	90	–	264	V AC	Two wires (no P.E.)
Frequency	$f_{LINE}$	47	50/60	64	Hz	–
No-load input power	$P_{stby\_NL}$	–	–	0.06	W	220 V AC
360 mW load input power	$P_{stby\_ML}$	–	–	0.55	W	220 V AC
<b>Output</b>						
Output voltage	$V_{OUT}$	–	12	–	V	±3%
Output current	$I_{OUT}$	0.030	0.625	1.25	A	–
Output voltage ripple	$V_{RIPPLE}$	–	–	360	mV	20 MHz BW
Maximum power output	$P_{OUT\_Max}$	–	–	15	W	–
Output overvoltage protection (OVP)	–	–	18	–	V	Short R26 resistor during system operation at no load
<b>Efficiency</b>						
Max. load	$\eta$	–	83	–	%	115 V AC/220 V AC
Average efficiency at 25%, 50%, 75%, and 100% of $P_{OUT\_Max}$	$\eta_{avg}$	84	–	–	%	115 V AC/220 V AC
<b>Environmental</b>						
Conducted EMI	–	7	–	–	dB	EN 55022 Class-B
ESD	–	8	–	–	kV	EN 61000-4-2
<b>Surge immunity</b>						
Differential Mode (DM)	–	2	–	–	kV	EN 61000-4-5
Common Mode (CM)	–	4	–	–	kV	
<b>Operating ambient temperature</b>						
Ambient temperature	$T_{amb}$	0	–	50	°C	Free convection, sea level
<b>Dimension</b>						
PCB	–	60 × 80 × 32			mm	L × W × H

# 15 W auxiliary SMPS for air conditioner using CoolSET™ ICE5AR4770BZS-1

REF\_5AR4770BZS-1\_15W1

Schematic

## 4 Schematic

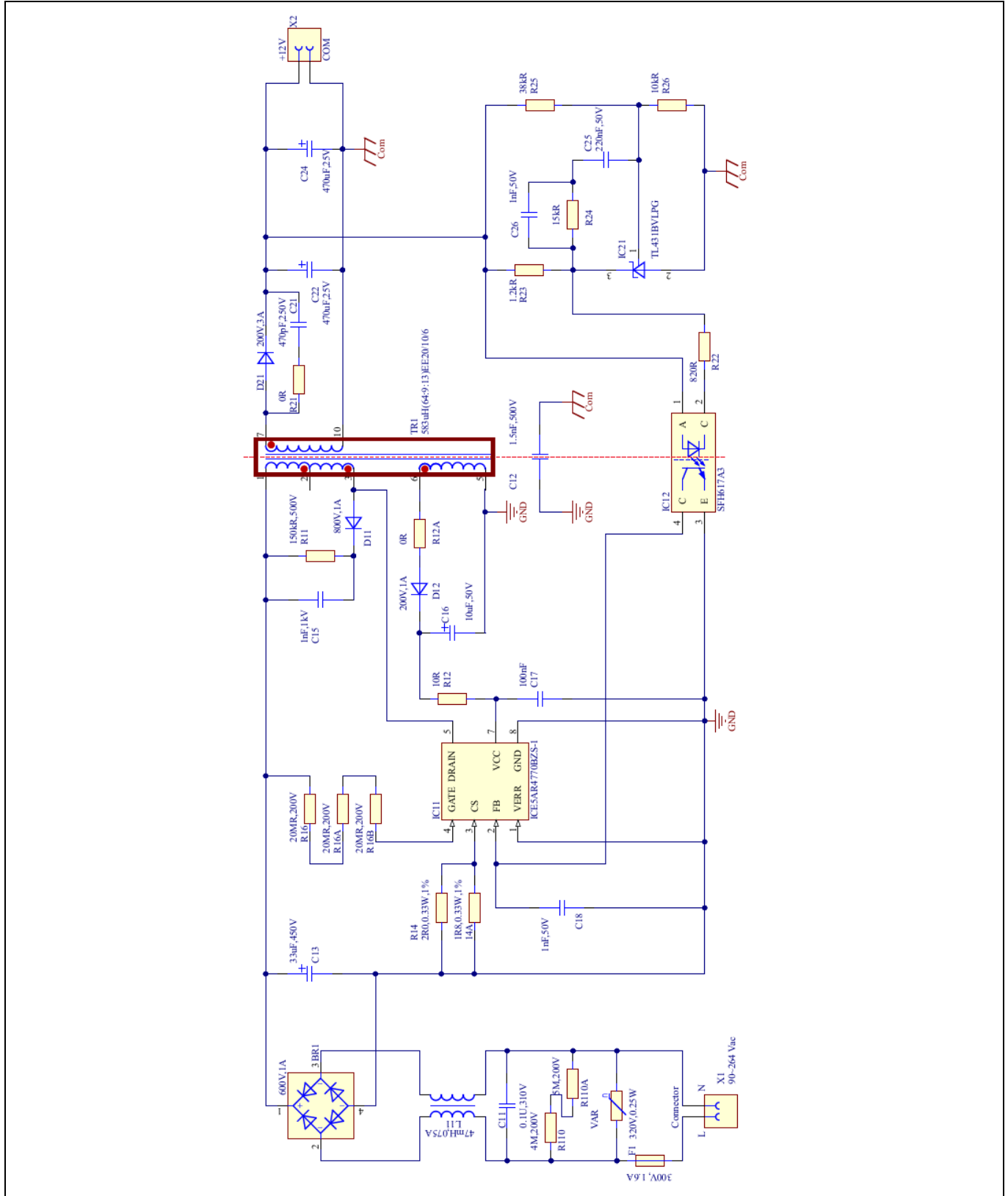


Figure 3 REF\_5AR4770BZS-1\_15W1



## **5 Circuit description**

In this section, the design circuit for the SMPS unit will be briefly described by the different functional blocks. For details of the design procedure and component selection for the flyback circuitry, see the IC design guide [2] and calculation tool [3].

### **5.1 EMI filtering and line rectification**

The input of the power supply unit is taken from the AC power grid, which is in the range of 90 V AC ~ 264 V AC. The fuse (F1) protects the system in case of excess current entering the system circuit due to any fault. The varistor VAR connected across L and N absorbs the line surge transient. L11 and C11 form a filter to attenuate the DM and CM conducted EMI noise. Capacitor (C11) must be X-capacitor grade. Resistors (R110 and R110A) are used to discharge the X-capacitor when the AC is off to fulfill the IEC61010-1 and UL1950 safety requirements. The bridge rectifier (BR1) rectifies the AC input into DC voltage, filtered by the bulk capacitor (C13).

### **5.2 Flyback converter power stage**

The flyback converter power stage consists of capacitor (C13), transformer (TR1), a primary HV MOSFET (integrated into the ICE5AR4770BZS-1 switching controller), secondary rectification diode (D21), and secondary output capacitors (C22 and C24).

When the primary HV MOSFET turns on, energy is stored in the transformer. When it turns off, the stored energy is released to the output capacitors, and the output is loaded through the output diode (D21).

Sandwich winding structure for the transformer (TR1) is used to reduce the leakage inductance, and so the loss in the clamper circuit is reduced. The transformer (TR1) has a single output winding, the  $V_{OUT}$  (12 V). The output rectification of  $V_{OUT}$  is provided by the diode (D21) through filtering of capacitors (C22 and C24). All the secondary capacitors must be the low-ESR type, which can effectively reduce the switching ripple. Together with the Y-capacitor (C12) across the primary and secondary side, the EMI noise can be further reduced to comply with EN 55022 Class-B specifications.

### **5.3 Control of flyback converter through CoolSET™ 5<sup>th</sup> Generation Fixed Frequency Plus ICE5AR4770BZS-1 switching controller**

#### **5.3.1 Integrated HV power MOSFET**

CoolSET™ ICE5AR4770BZS-1 switching controller is a seven-pin device in a DIP-7 package. It has been integrated with the new fixed-frequency PWM controller and all necessary features and protections, and most importantly the 700 V superjunction (SJ) CoolMOS™ power MOSFET from Infineon. Therefore, the schematic is much simplified and the circuit design is made much easier.

#### **5.3.2 Current sensing (CS)**

The ICE5AR4770BZS-1 is a current mode switching controller. The peak current is controlled cycle-by-cycle by the CS resistors (R14 and R14A) which are connected across the CS pin (pin 3) and ground (pin 8) so that transformer saturation can be avoided and the system is more robust and reliable.

### **5.3.3 Feedback and compensation network**

Resistor (R25) is used to sense the  $V_{OUT}$  and feedback (FB) to the reference pin (pin 1) of an error amplifier IC (IC21) with reference to the voltage at resistor (R26). A type 2 compensation network capacitors and resistor (C25, C26, and R24) is connected between the output pin (pin 3) and the reference pin (pin 2) of the IC (IC21) to stabilize the system. The IC (IC21) further connects to pin 2 of the optocoupler, IC (IC12) with a series resistor (R22) to convert the control signal to the primary side through the connection of pin 4 of the IC (IC12) to the ICE5AR4770BZS-1 switching controller FB pin (pin 2) and complete the control loop. Both the optocoupler IC (IC12) and the error amplifier IC (IC21) are biased by  $V_{OUT}$ ; IC (IC12) is a direct connection while IC (IC21) is through resistor (R23).

The FB pin of the ICE5AR4770BZS-1 switching controller is a multi-function pin which is used to select the entry burst power level and also the burst-on/burst-off sense input during active burst mode (ABM).

## **5.4 Unique features**

This section describes the CoolSET™ 5<sup>th</sup> Generation Fixed Frequency Plus ICE5AR4770BZS-1 switching controller to support the requirements of an air conditioner auxiliary power system.

### **5.4.1 Fast self-start-up and sustaining of $V_{CC}$**

The IC start-up uses the cascode structure integrated into the package to charge up the  $V_{CC}$  capacitor during the start-up stage. The GATE pin (pin 4) is a multi-function pin and it serves as the start-up pin with the connection to pull-up resistors (R16, R16A, and R16B) from the bus voltage during the start-up phase. The device is implemented with two steps of charging current: the smaller current 0.2 mA (from  $V_{VCC} = 0\text{ V} \sim 1.1\text{ V}$ ) and the larger current 3.2 mA ( $V_{VCC} = 1.1\text{ V} \sim 16\text{ V}$ ). The start-up time is the sum of those two charging times. With the  $V_{CC}$  capacitor (C16) at 10  $\mu\text{F}$ , the start-up time is 0.15 s.

After start-up, the IC  $V_{CC}$  supply is sustained by the auxiliary winding of the transformer (TR1), which needs to support the  $V_{CC}$  to be above the undervoltage lockout (UVLO) voltage (10 V typ.) through the rectifier circuit (D12, R12, R12A, and C16).

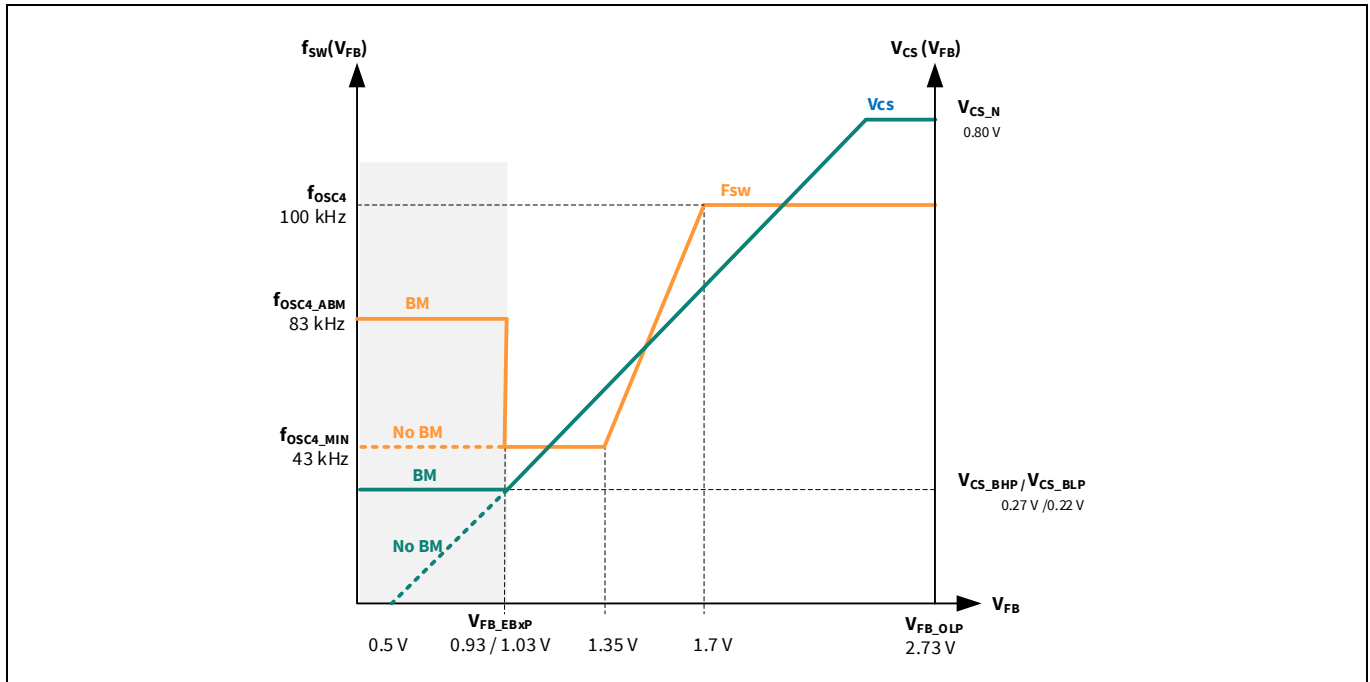
### **5.4.2 Frequency reduction control**

ICE5AR4770BZS-1 switching controller can be operated in either discontinuous conduction mode (DCM) or continuous conduction mode (CCM) with frequency-reduction features. This reference board is designed to operate in DCM. When the system is operating at maximum power, the controller will switch at the Fixed Frequency of 100 kHz. To achieve a better efficiency between light load and medium load, frequency reduction is implemented, and the reduction curve is shown in [Figure 4](#). The  $V_{CS}$  is clamped by the current limit threshold or by the PWM opamp while the switching frequency is reduced. The minimum switching frequency possible is  $f_{OSC4\_MIN}$  (43 kHz) under disabled burst mode setting.

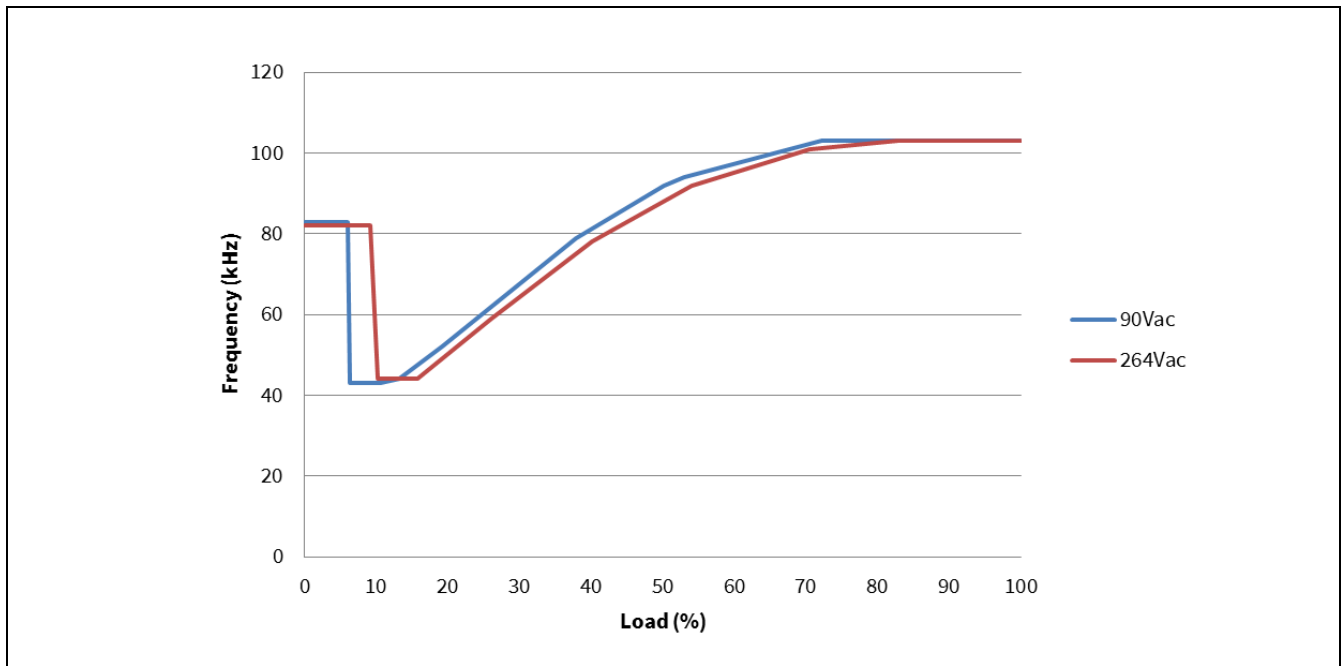
# 15 W auxiliary SMPS for air conditioner using CoolSET™ ICE5AR4770BZS-1

REF\_5AR4770BZS-1\_15W1

## Circuit description



**Figure 4** Frequency reduction curve



**Figure 5** Frequency-reduction curve of REF\_5AR4770BZS-1\_15W1

The measured frequency-reduction curve of REF\_5AR4770BZS-1\_15W1 is shown in [Figure 5](#).

### 5.4.3 Frequency jittering with modulated gate drive

ICE5AR4770BZS-1 switching controller has a frequency jittering feature with modulated gate drive to reduce the EMI noise. The jitter frequency is internally set at 100 kHz ( $\pm 4$  kHz) and the jitter period is 4 ms.

### 5.4.4 System robustness and reliability through protection features

Protection is one of the major factors in determining whether the system is safe and robust. Therefore, sufficient protection is necessary. ICE5AR4770BZS-1 switching controller provides comprehensive protection to ensure the system is operating safely. Protections include  $V_{CC}$  OV and UV, overload, overtemperature (controller junction), and  $V_{CC}$  short-to-GND. When those faults are detected, the system will enter protection mode until the fault is removed, and then resume normal operation. The following table lists the protections and the failure conditions.

**Table 3 Protection functions of ICE5AR4770BZS-1 switching controller**

Protection function	Failure condition	Protection mode
$V_{CC}$ OV	$V_{VCC} > V_{VCC\_OV}$	Extended cycle skip auto-restart
$V_{CC}$ UV	$V_{VCC} < V_{VCCoff}$	Auto-restart
Overload	$V_{FB} > V_{FB\_OLP}$ and lasts for $t_{FB\_OLP\_B}$	Extended cycle skip auto-restart
Over temperature	$T_J > 140^{\circ}\text{C}$ (40°C hysteresis)	Non-switch auto-restart
$V_{CC}$ short-to-GND ( $V_{VCC} = 0\text{ V}$ , $R_{StartUp} = 50\text{ M}\Omega$ and $V_{DRAIN} = 90\text{ V}$ )	$V_{VCC} < V_{VCC\_SCP}$ , $I_{VCC\_Charge1} \approx -0.2\text{ mA}$	Cannot start up

### 5.5 Clamper circuit

A clamper network, a diode, capacitor, and resistor (D11, C15, and R11) are used to reduce the switching voltage spikes at the drain pin, which are generated from the leakage inductance of the transformer (TR1). This is a dissipative circuit and the selection of the resistor (R11) and capacitor (C15) needs to be fine-tuned.

# 15 W auxiliary SMPS for air conditioner using CoolSET™ ICE5AR4770BZS-1

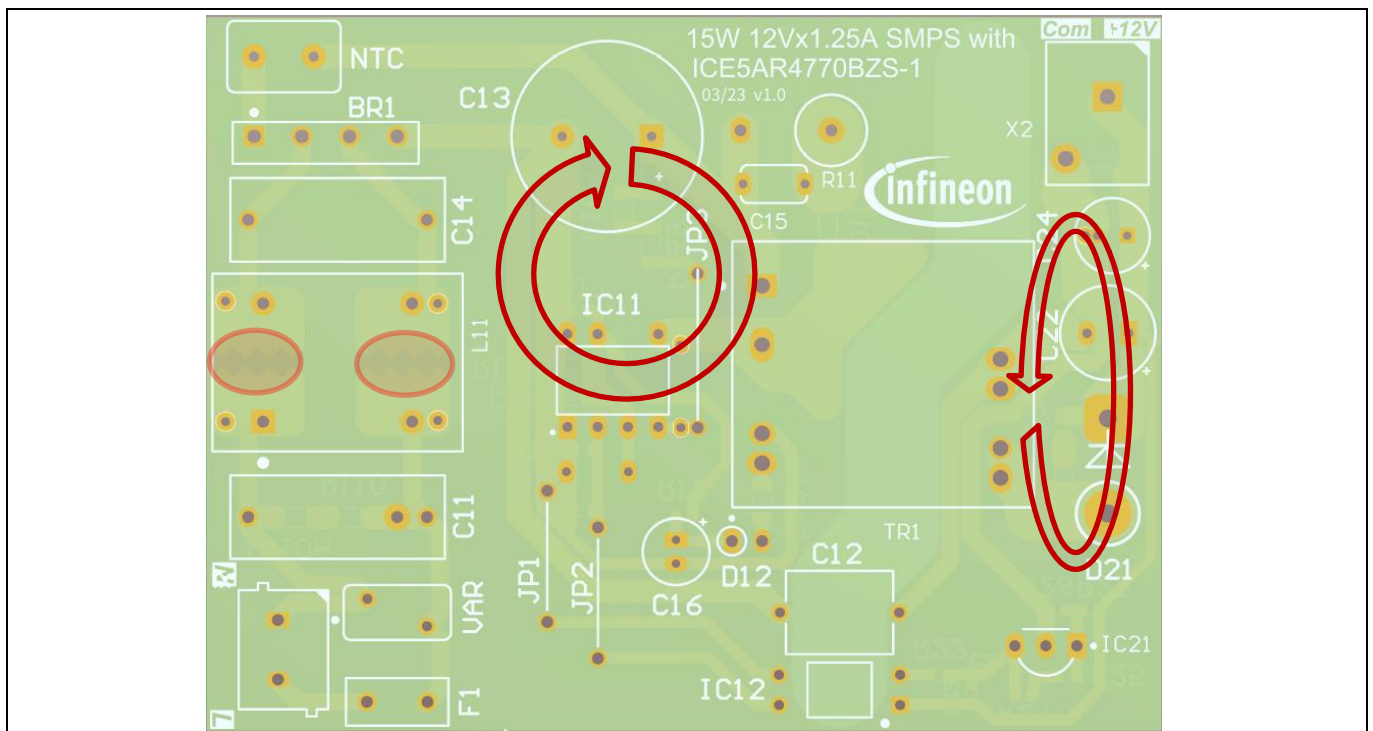
REF\_5AR4770BZS-1\_15W1

## Circuit description

### 5.6 PCB design recommendations

Following are the recommendations for a good PCB design layout.

- The power loop needs to be as small as possible (see Figure 6). There are two power loops in the reference design; one from the primary side and one from the secondary side. For the primary side, it starts from the bulk capacitor (C13) positive to the bulk capacitor negative. The power loop components include capacitor (C13), the main primary transformer winding (pin 1 and pin 3 of TR1), the DRAIN pin, and the CS pin of the CoolSET™ IC11 and CS resistors (R14 and R14A). The secondary side power loop comprises the secondary transformer windings (pin 7 and pin 10 of TR1), output diode (D21), and output capacitors (C22 and C24).
- Use the star ground connection to avoid unexpected high frequency (HF) noise coupling affecting control. The ground of the small-signal components, e.g., capacitors (C17 and C18), and the emitter of the optocoupler (pin 3 of IC12), etc., must connect directly to the IC ground (pin 8 of IC11). Then it connects to the negative terminal of the capacitor (C13) directly.



**Figure 6** PCB layout recommendations

- Adding the spark-gap (PCB saw-tooth, 0.5 mm separation) pattern under the input CM Choke (CMC) (L11) can increase the system input line surge capability.
- Separating the HV components and low voltage (LV) components, e.g., the clamper circuit (D11, R11, and C15) at the top part of the PCB (see Figure 6) and the other LV components at the lower part of the PCB, can reduce the spark-over chance of the high energy surge during ESD or a lightning surge tests.

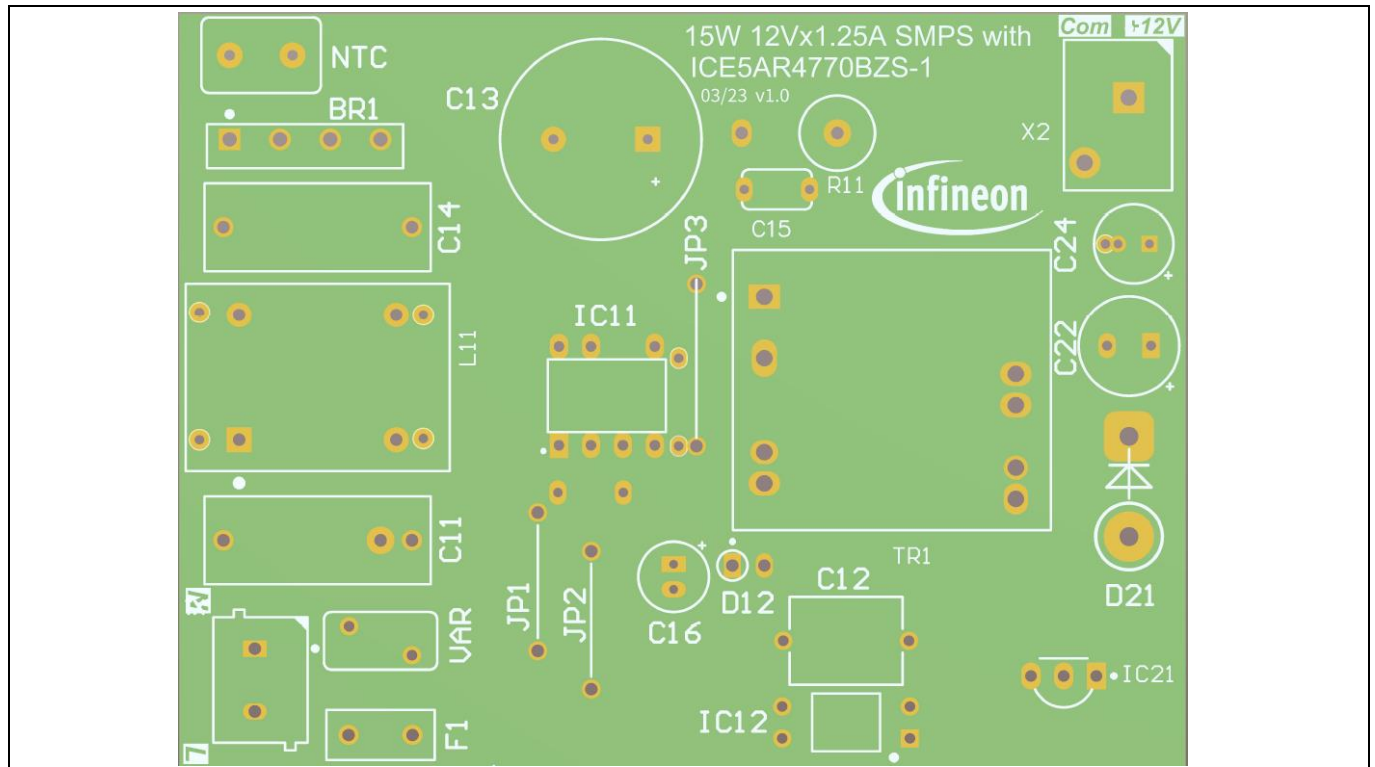
**15 W auxiliary SMPS for air conditioner using CoolSET™  
ICE5AR4770BZS-1**

REF\_5AR4770BZS-1\_15W1

PCB layout

**6 PCB layout**

**6.1 Top side**



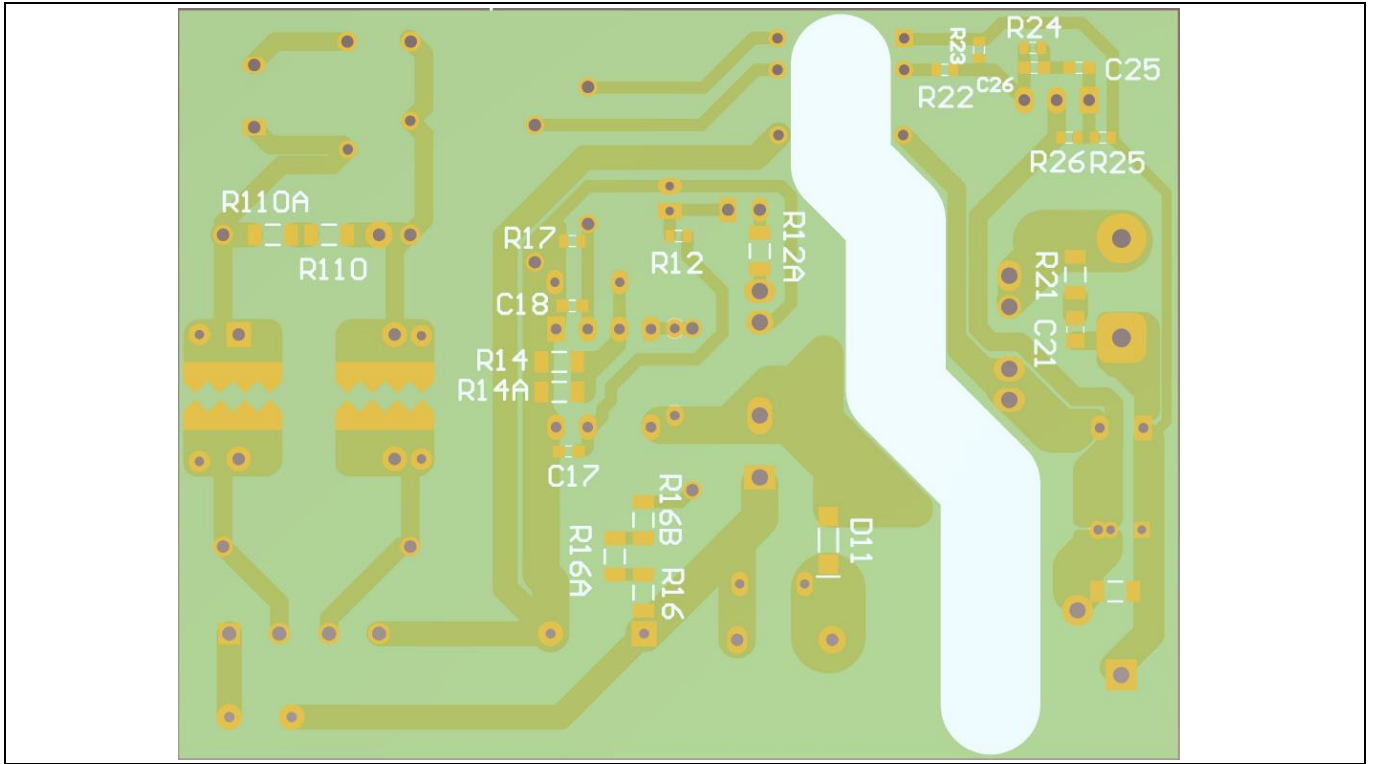
**Figure 7 Top-side component legend**

**15 W auxiliary SMPS for air conditioner using CoolSET™  
ICE5AR4770BZS-1**

REF\_5AR4770BZS-1\_15W1

PCB layout

**6.2 Bottom side**



**Figure 8 Bottom-side copper and component legend**

# 15 W auxiliary SMPS for air conditioner using CoolSET™

## ICE5AR4770BZS-1



REF\_5AR4770BZS-1\_15W1

Bill of materials

## 7 Bill of materials

Table 4 BOM (V 0.0)

No.	Designator	Description	Part number	Manufacturer	Qty
1	BR1	600 V, 1 A	S1VBA60	Shindengen	1
2	C11	0.1 $\mu$ F, 310 V	890334025017CS	Würth Elektronik	1
3	C12	1.5 nF, 500 V	DE1E3RA152MA4BQ01F	Murata	1
4	C13	33 $\mu$ F, 450 V	450BXC33MEFC16X25	Rubycon	1
5	C15	1 nF, 1000 V	RDE7U3A102J2K1H03	Murata	1
6	C16	10 $\mu$ F, 50 V	50PX10MEFC5X11	Rubycon	1
7	C17	100 nF	GRM188R71H104KA93D	Murata	1
8	C18, C26	1 nF, 50 V	GRM1885C1H102GA01D	Murata	2
9	C21	470 pF, 250 V	GRM21A5C2E471JWA1#	Murata	1
10	C22, C24	470 $\mu$ F, 25 V	25ZLG470MEFC8X20	Rubycon	2
11	C25	220 nF, 50 V	GRM188R71H224KAC4D	Murata	1
12	D11	800 V, 1 A	US1K	–	1
13	D12	200 V, 1 A	1N4003	–	1
14	D21	200 V, 3 A	UF5402	–	1
15	F1	300 V, 1.6 A	36911600000	–	1
16	IC11	CoolSET™	ICE5AR4770BZS-1	Infineon	1
17	IC12	Optocoupler, CTR 100 ~ 200% DIP-4	SFH617A-3X006	–	1
18	IC21	2.5 V shunt regulator, TO92	TL431BVLPG	–	1
19	JP1, JP2, NTC	Jumper	–	–	3
20	JP3	Insulated jumper	–	–	1
21	L11	47 mH, 0.75 A	750342434	Würth Elektronik	1
22	R11	150k R	MO2CT631R154J	–	1
23	R12	10 R	0603 Resistor	–	1
24	R12A, R21	0 R	1206 Resistor	–	2
25	R14	2R0, 0.33 W, 1%	ERJ8BQF2R0V	–	1
26	R14A	1R8, 0.33 W, 1%	ERJ-8BQF1R8V	–	1
27	R16, R16A, R16B	20 MR, 200 V	1206 Resistor	–	3
28	R22	820 R	0603 Resistor	–	1
29	R23	1.2k R	0603 Resistor	–	1
30	R24	15k R	0603 Resistor	–	1
31	R25	38k R	0603 Resistor	–	1
32	R26	10k R	0603 Resistor	–	1



# 15 W auxiliary SMPS for air conditioner using CoolSET™

## ICE5AR4770BZS-1



REF\_5AR4770BZS-1\_15W1

### Bill of materials

No.	Designator	Description	Part number	Manufacturer	Qty
33	R110	4 M, 200 V	1206 Resistor	-	1
34	R110A	5 M, 200 V	1206 Resistor	-	1
35	TR1	583 $\mu$ H (64:9:13) EE20/10/6	750343814 (Rev. 03)	Würth Elektronik	1
36	VAR	320 V, 0.25 W	B72207S2321K101	Epcos	1
37	X1	Connector	691 102 710 002	Würth Elektronik	1
38	X2	Connector	691 412 120 002B	Würth Elektronik	1

# 15 W auxiliary SMPS for air conditioner using CoolSET™ ICE5AR4770BZS-1

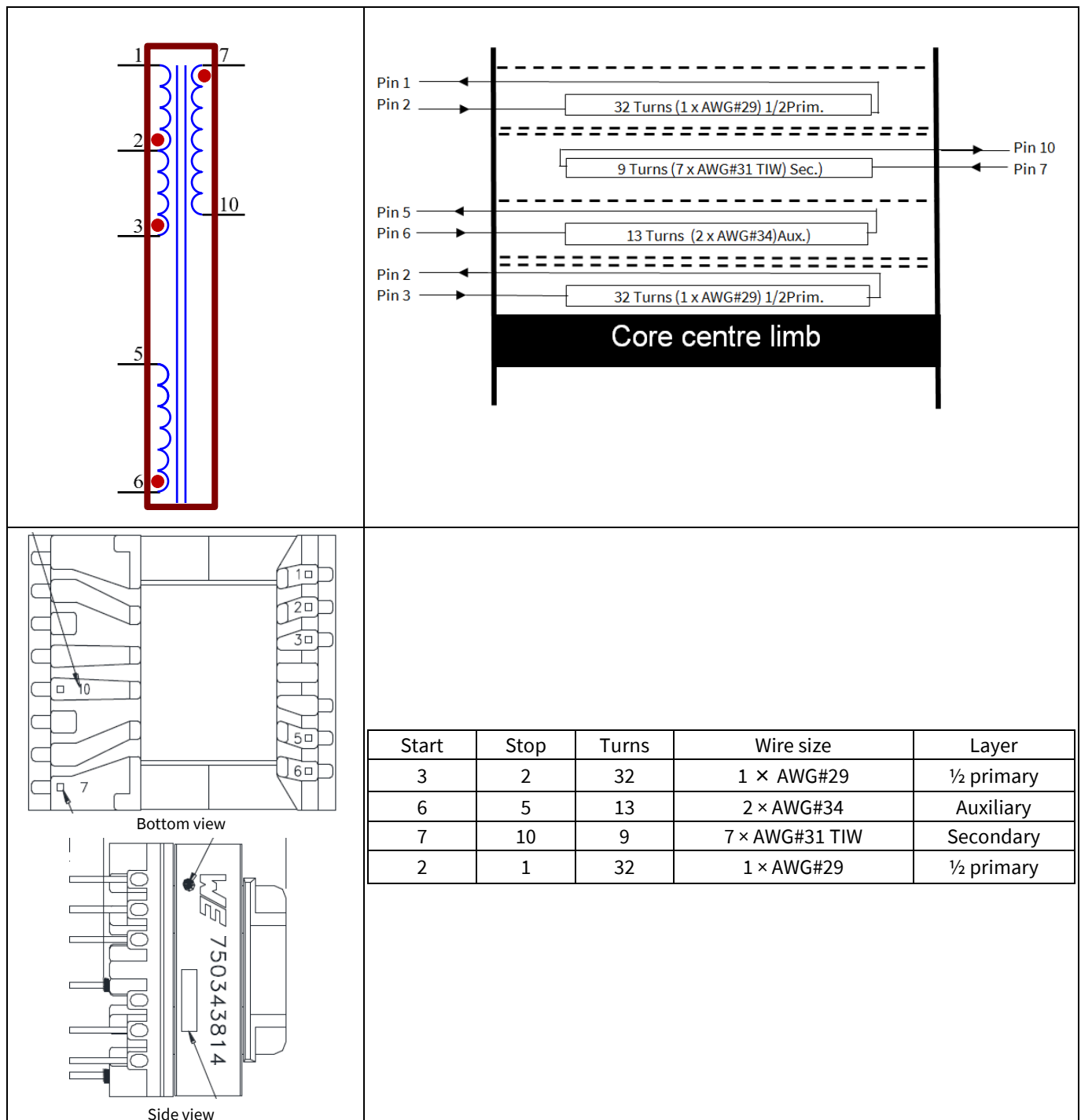
REF\_5AR4770BZS-1\_15W1

Transformer specification

## 8 Transformer specification

(See [Appendix A: WE transformer specification.](#))

- **Core and materials:** EE20/10/6, TP4A (TDG)
- **Bobbin:** 070-5643 (14-pin, THT, horizontal version)
- **Primary inductance:**  $L_p = 583 \mu\text{H}$  ( $\pm 10$  percent), measured between pin 4 and pin 6
- **Manufacturer and part number:** Würth Elektronik (750343814) Rev. 03



**Figure 9 Transformer structure**

## 9 Measurement data and graphs

**Table 5 Measurement data**

Input (V AC/Hz)	Description	P <sub>in</sub> (W)	V <sub>OUT1</sub> (V DC)	I <sub>OUT1</sub> (A)	P <sub>out</sub> (W)	η (%)	η <sub>avg</sub> (%)	P <sub>in_OLP</sub> (W)	I <sub>out1_OLP</sub> (A)
90 V AC/ 60 Hz	No load	0.050	12.02	0.000				26.47	1.69
	Min. load	0.506	12.02	0.029	0.351	69.35			
	1/20 load	0.995	12.02	0.062	0.747	75.07			
	1/10 load	1.961	12.01	0.128	1.533	78.16			
	¼ load	4.496	12.01	0.306	3.680	81.86	81.63		
	Typ. Load	9.132	12.01	0.625	7.509	82.22			
	¾ load	13.693	12.01	0.932	11.191	81.73			
	Max. load	18.452	12.01	1.240	14.891	80.70			
115 V AC/ 60 Hz	No load	0.052	12.02	0.000				26.27	1.76
	Min. load	0.505	12.02	0.029	0.353	69.95			
	1/20 load	0.990	12.02	0.062	0.745	75.21			
	1/10 load	1.944	12.01	0.128	1.533	78.86			
	1/4 load	4.439	12.01	0.306	3.680	82.90	83.09		
	Typ. load	8.989	12.01	0.625	7.509	83.53			
	3/4 load	13.438	12.01	0.932	11.190	83.27			
	Max. load	18.014	12.01	1.240	14.890	82.66			
220 V AC/ 50 Hz	No load	0.058	12.02	0.000				26.15	1.83
	Min. load	0.530	12.01	0.029	0.351	66.19			
	1/20 load	1.032	12.01	0.062	0.745	72.19			
	1/10 load	2.004	12.01	0.128	1.533	76.47			
	1/4 load	4.472	12.01	0.306	3.679	82.26	83.68		
	Typ. load	8.952	12.01	0.625	7.502	83.80			
	3/4 load	13.268	12.00	0.932	11.184	84.29			
	Max. load	17.635	12.00	1.240	14.880	84.38			
264 V/ 50 Hz	No load	0.065	12.02	0.000				26.43	1.86
	Min. load	0.546	12.01	0.029	0.351	64.24			
	1/20 load	1.058	12.01	0.062	0.745	70.39			
	1/10 load	2.049	12.01	0.128	1.532	74.81			
	1/4 load	4.534	12.01	0.306	3.678	81.13	83.02		
	Typ. load	9.020	12.00	0.625	7.503	83.18			
	3/4 load	13.371	12.00	0.932	11.181	83.62			
	Max. load	17.677	12.00	1.240	14.877	84.16			

- No-load condition (no load) : 12 V at 0 A
- Minimum load condition (min. load) : 12 V at 30 m A
- 1/20 load condition (1/20 load) : 12 V at 62.5 mA
- 1/10 load condition (1/10 load) : 12 V at 125 mA

# 15 W auxiliary SMPS for air conditioner using CoolSET™ ICE5AR4770BZS-1

REF\_5AR4770BZS-1\_15W1

## Measurement data and graphs

- 1/4 load condition (1/4 load) : 12 V at 0.3125 A
- Typical load condition (typ. load) : 12 V at 0.625 A
- 3/4 load condition (3/4 load) : 12 V at 0.9375 A
- Maximum load condition (max. load) : 12 V at 1.25 A

### 9.1 Load regulation

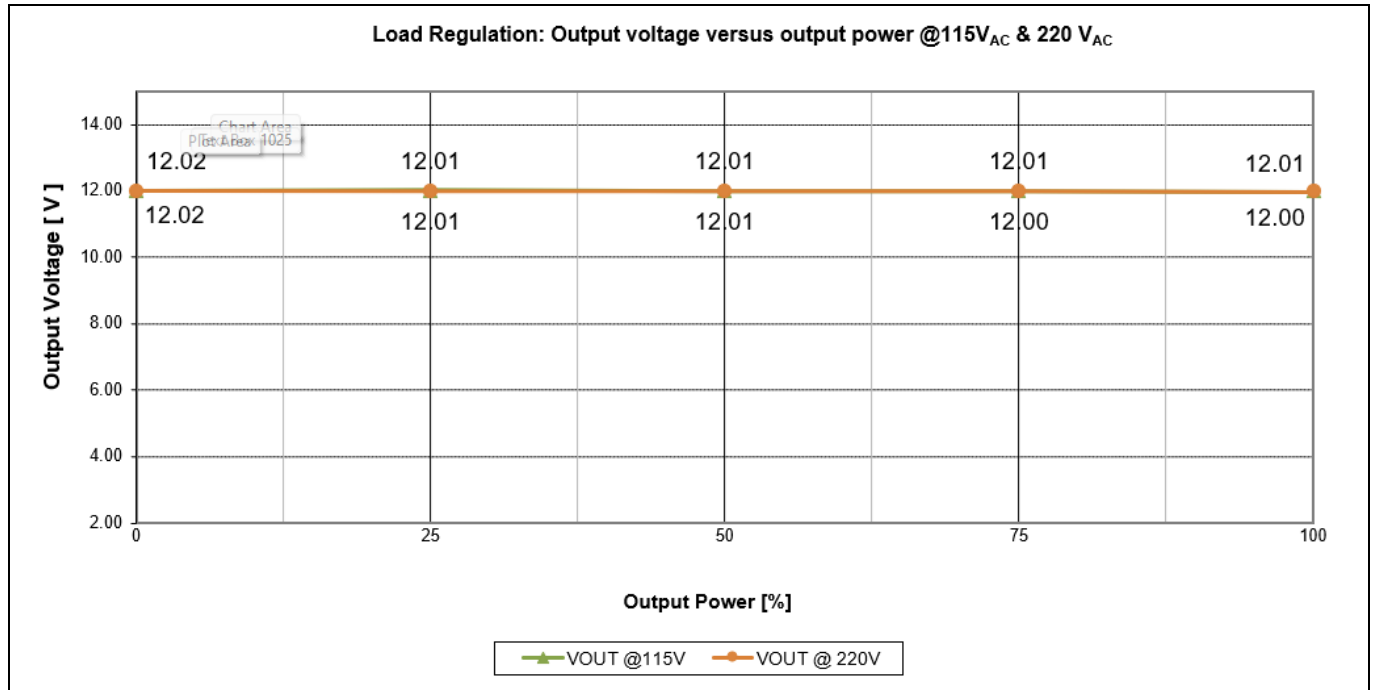


Figure 10 Load regulation V<sub>OUT</sub> vs. output power

# 15 W auxiliary SMPS for air conditioner using CoolSET™ ICE5AR4770BZS-1

REF\_5AR4770BZS-1\_15W1

Measurement data and graphs

## 9.2 Line regulation

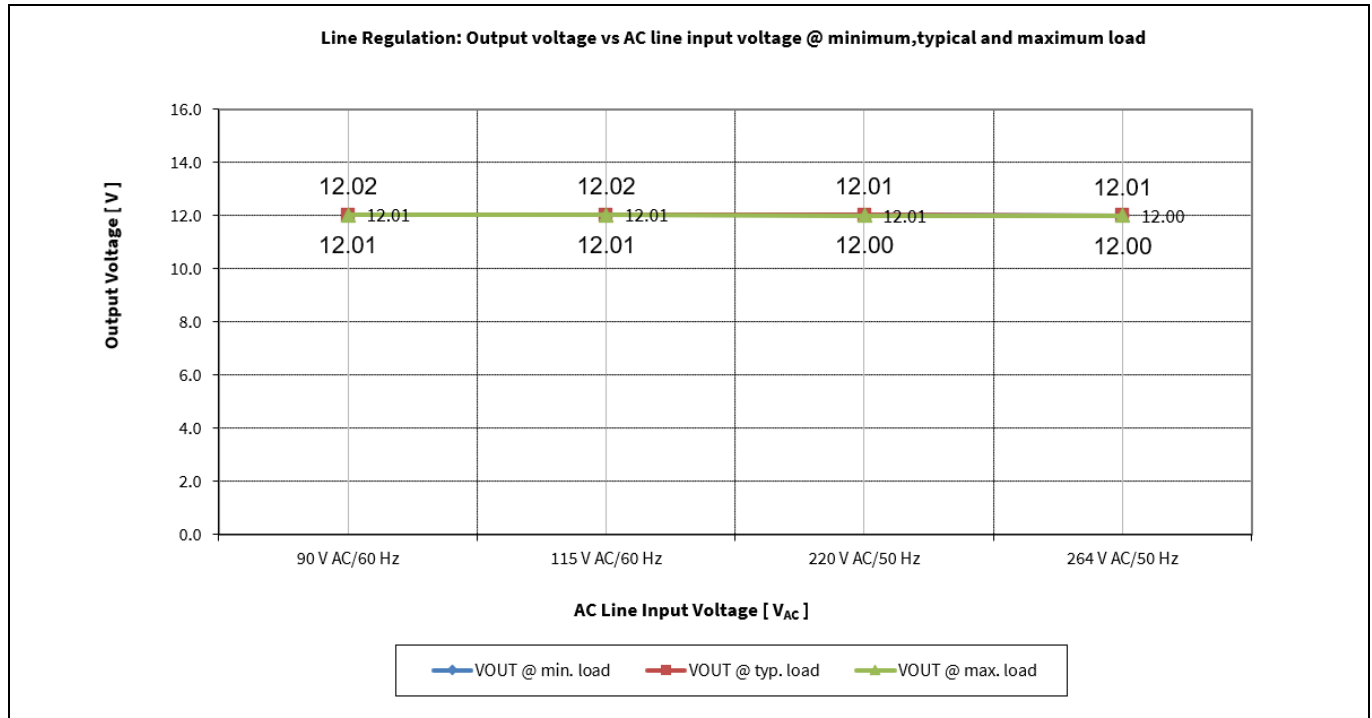
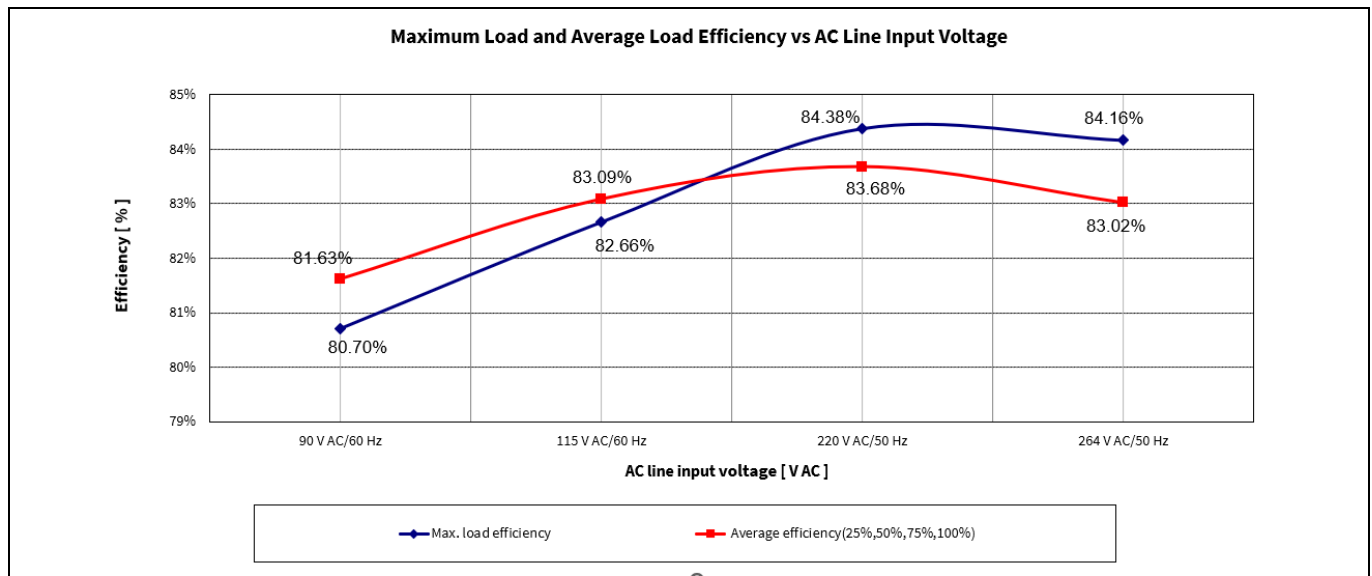


Figure 11 Line regulation:  $V_{OUT}$  vs. AC-line input voltage

## 9.3 Efficiency vs. AC-line input voltage



# 15 W auxiliary SMPS for air conditioner using CoolSET™ ICE5AR4770BZS-1

REF\_5AR4770BZS-1\_15W1

Measurement data and graphs

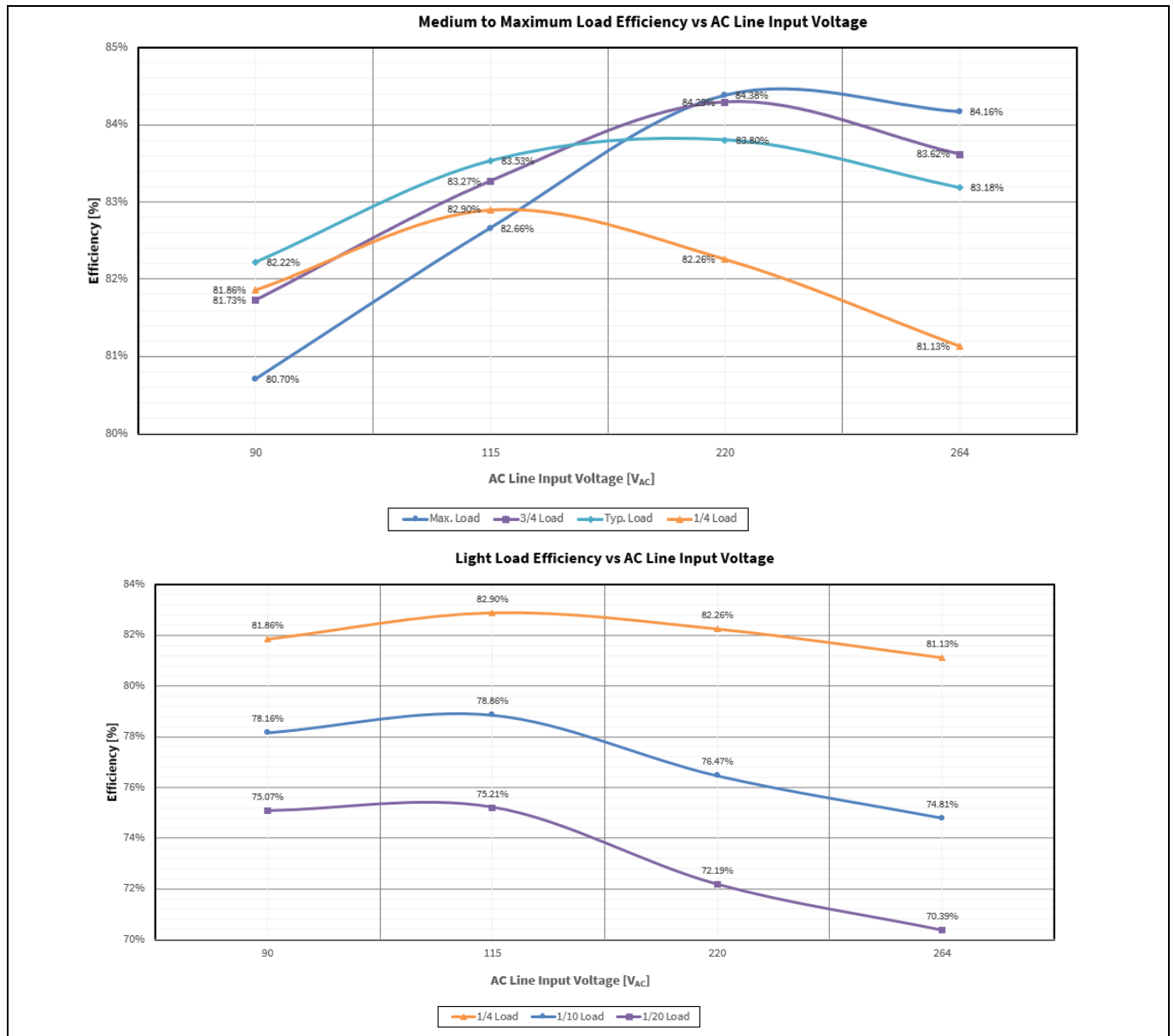


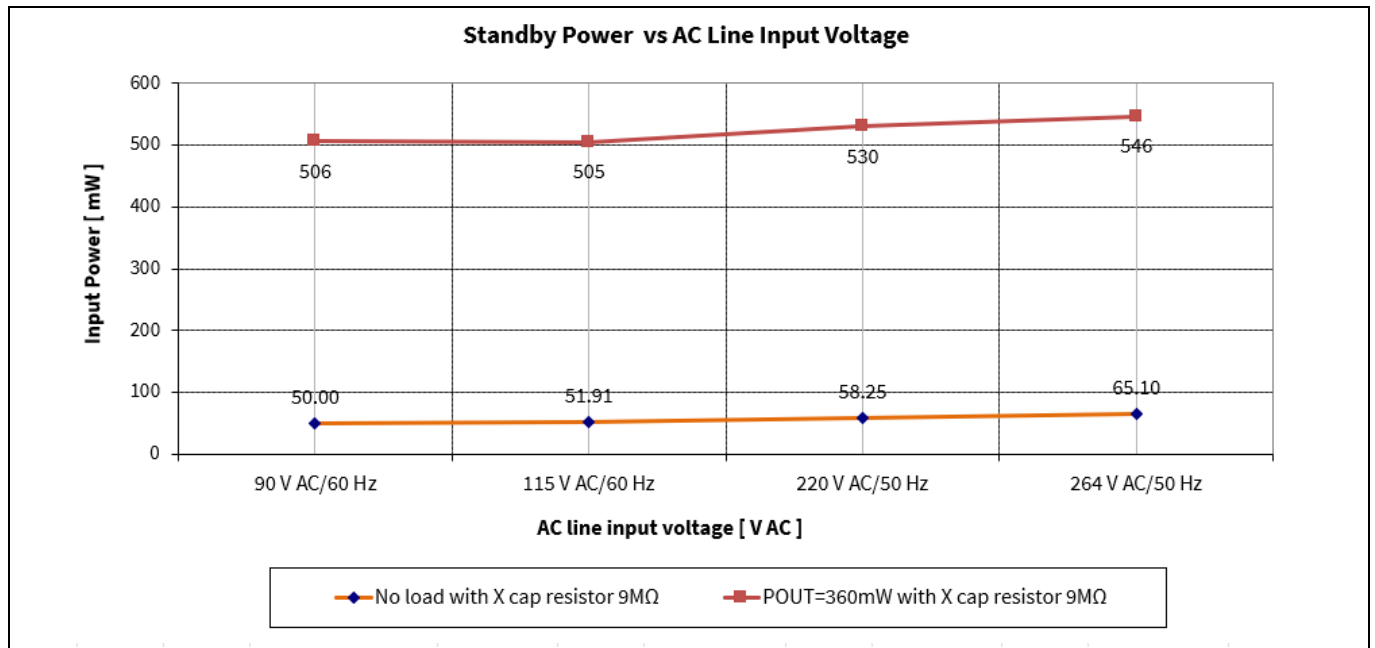
Figure 12 Efficiency vs. AC-line input voltage

# 15 W auxiliary SMPS for air conditioner using CoolSET™ ICE5AR4770BZS-1

REF\_5AR4770BZS-1\_15W1

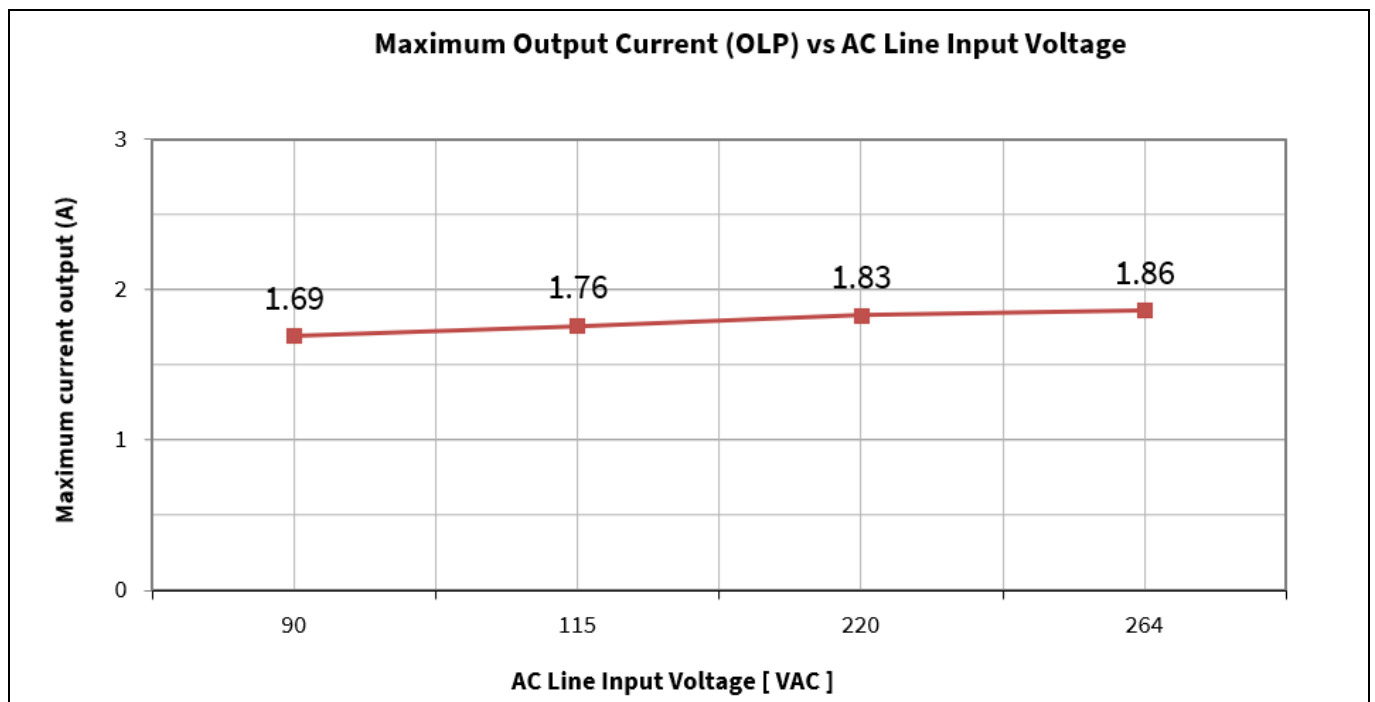
Measurement data and graphs

## 9.4 Standby power



**Figure 13** Standby power at no load ( $P_{stby\_NL}$ ) and 360 mW load ( $P_{stby\_ML}$ ) vs. AC-line input voltage (measured by WT310HC power meter from Yokogawa – integration mode)

## 9.5 Maximum output current



**Figure 14** Maximum output current (before over-load protection) vs. AC-line input voltage

# 15 W auxiliary SMPS for air conditioner using CoolSET™ ICE5AR4770BZS-1

REF\_5AR4770BZS-1\_15W1

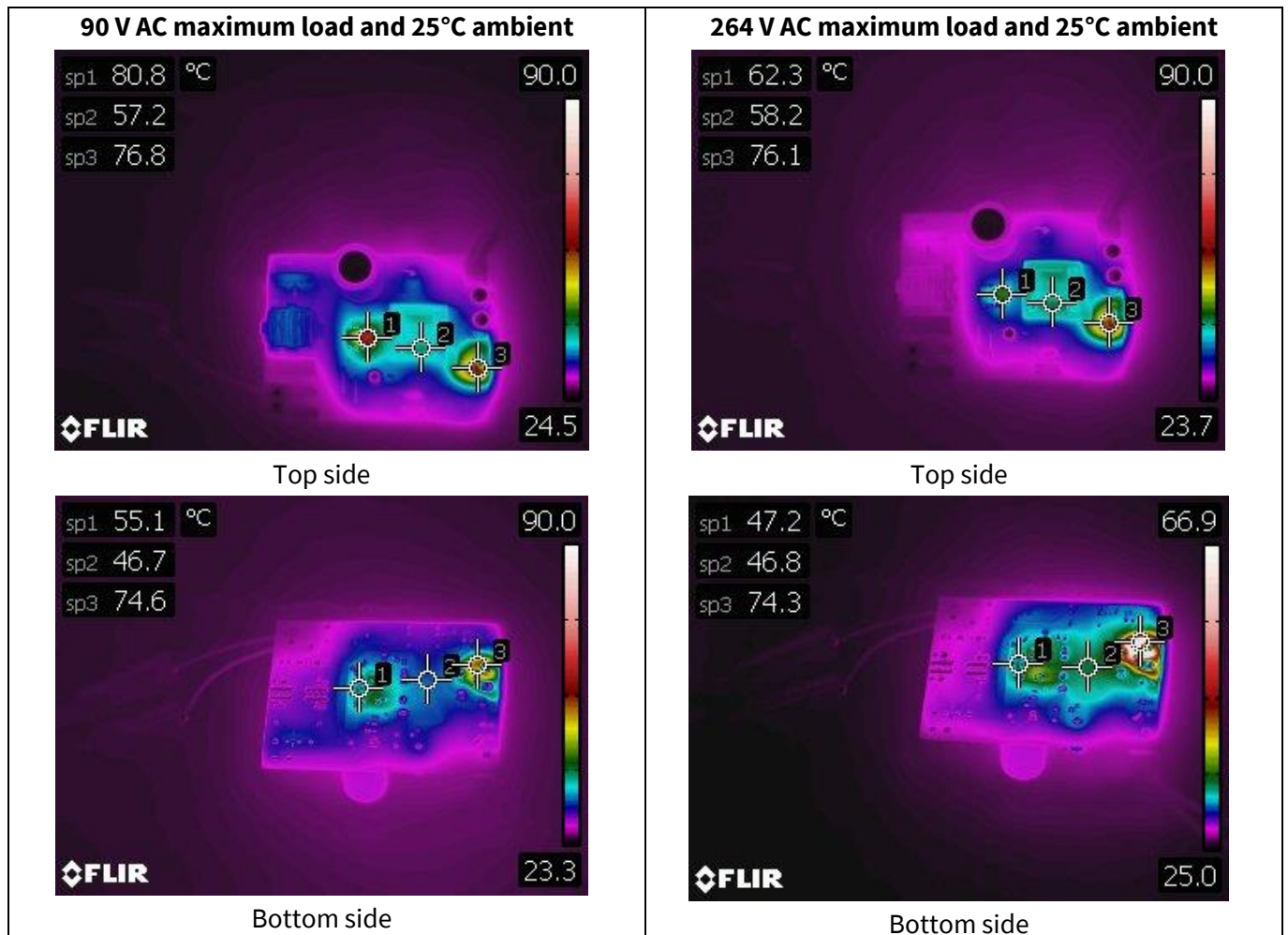
Thermal measurement

## 10 Thermal measurement

The thermal testing of the reference design board is done in the open air without forced ventilation at an ambient temperature of 25°C. An infrared thermography camera (FLIR-T62101) is used to capture the thermal reading of particular components. The measurements are taken at the maximum load running for one hour. The tested input voltage was 90 V AC and 264 V AC.

**Table 6 Component temperature at full load (12 V, 1.25 A) under  $T_{amb} = 25^{\circ}\text{C}$**

Circuit code	Major component	90 V AC ( $^{\circ}\text{C}$ )	264 V AC ( $^{\circ}\text{C}$ )
IC11	ICE5AR4770BZS-1	80.8	62.3
R14	CS resistor	55.1	47.2
TR1	Transformer	57.2	58.2
BR1	Bridge diode	47.2	33.6
R11	Clamper resistor	45.5	42.5
L11	Input CMC	47.1	32.3
D21	Output diode	76.8	76.1
-	Ambient	25.0	25.0



**Figure 15 Infrared thermal image of REF\_5AR4770BZS-1\_15W1**



# 15 W auxiliary SMPS for air conditioner using CoolSET™ ICE5AR4770BZS-1

REF\_5AR4770BZS-1\_15W1

Waveforms

## 11 Waveforms

### 11.1 Start-up at low/high AC-line input voltage with maximum load

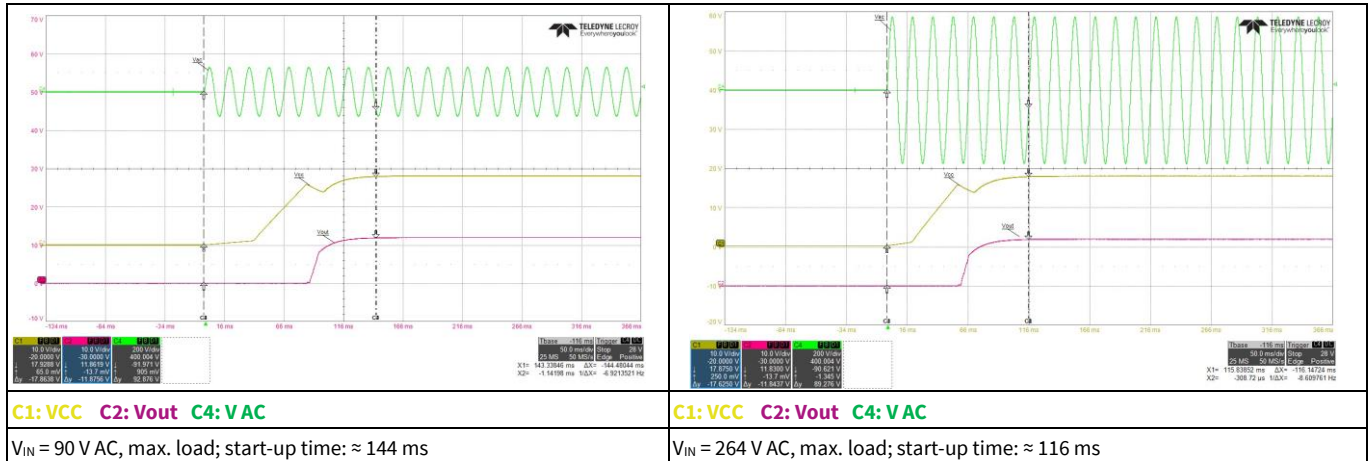


Figure 16 Start-up

### 11.2 Soft-start

The soft-start for the latest CoolSET™ 5<sup>th</sup> Generation Fixed Frequency Plus switching controller from Infineon is implemented by having a four-level step of current limit for the first 12 ms. The frequency for the first 3 ms is low (43 kHz) to minimize current spikes due to CCM during start-up. After the first 3 ms, the switching frequency changes to 100 kHz.

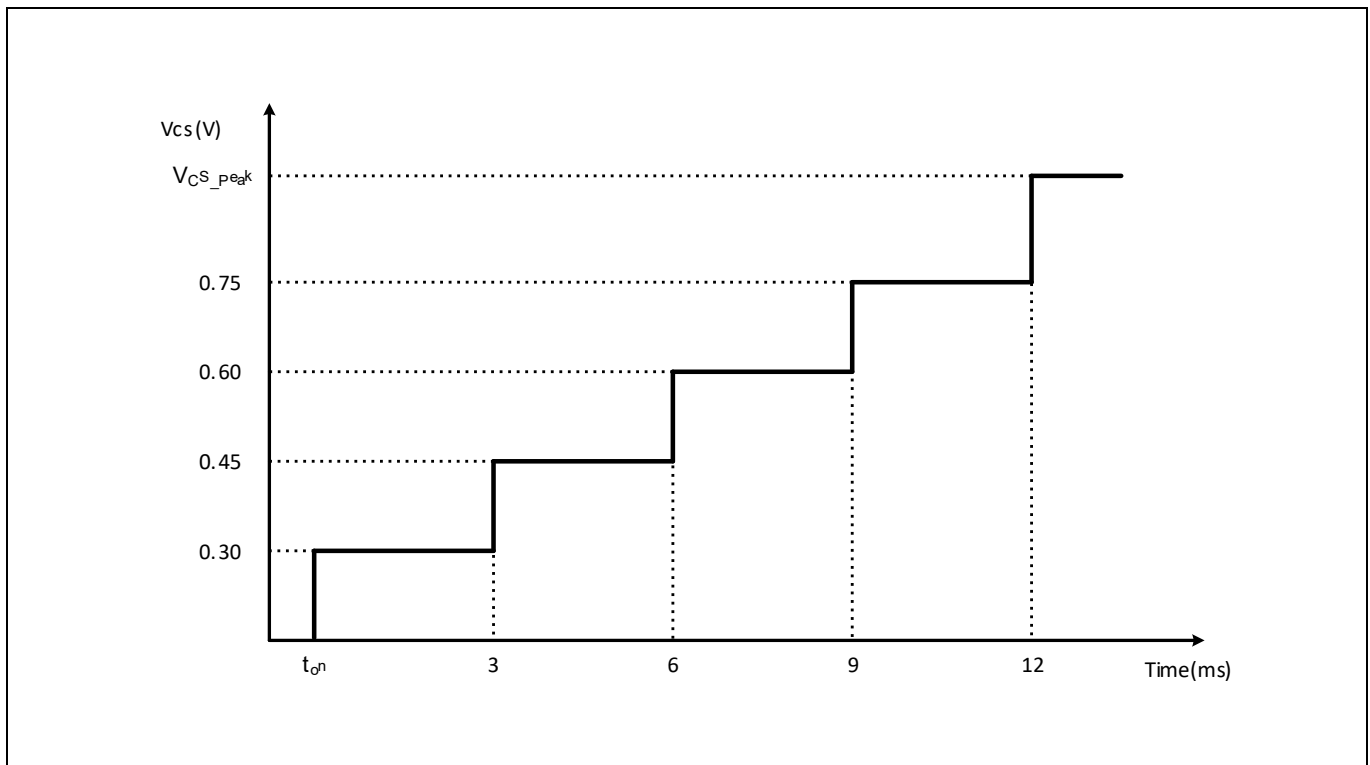


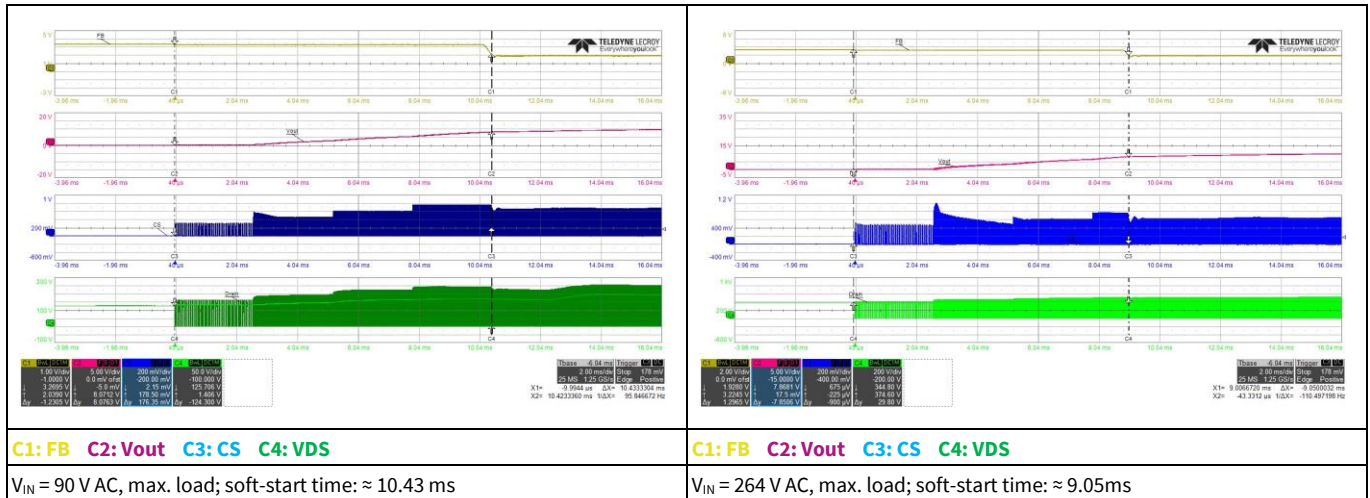
Figure 17 Current limit during soft-start

# 15 W auxiliary SMPS for air conditioner using CoolSET™

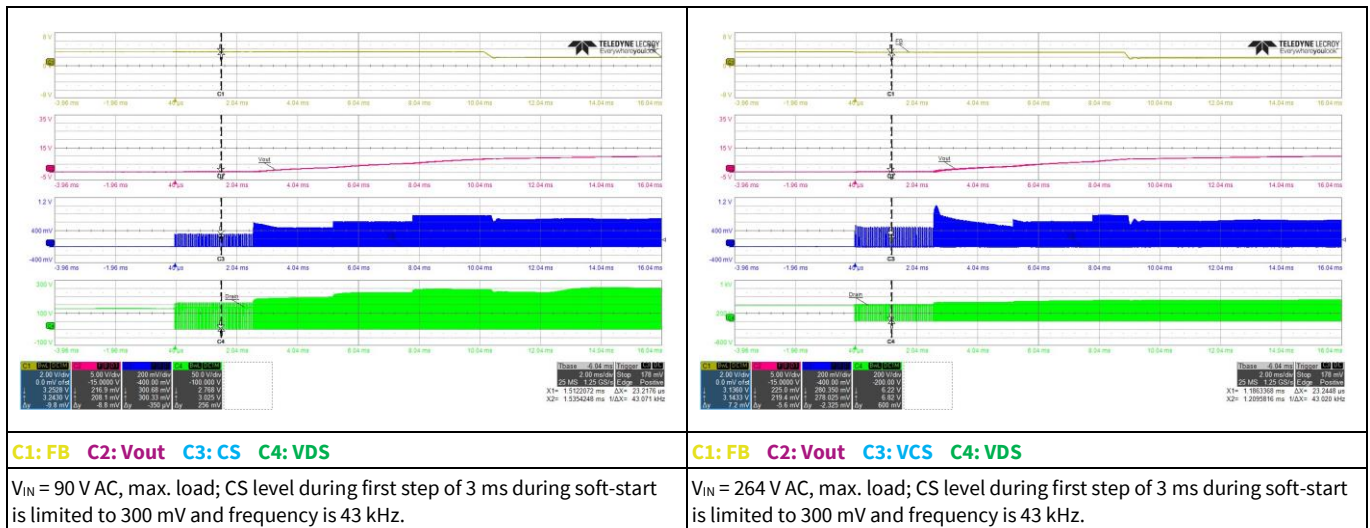
## ICE5AR4770BZS-1

REF\_5AR4770BZS-1\_15W1

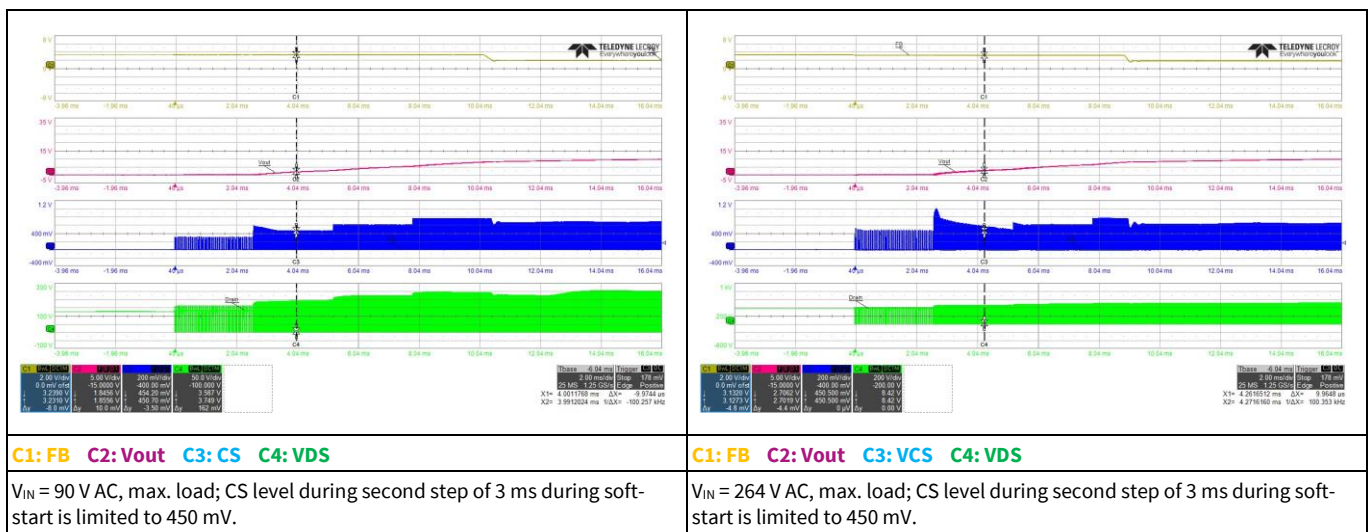
### Waveforms



**Figure 18 Soft-start**



**Figure 19 Soft-start - first step**



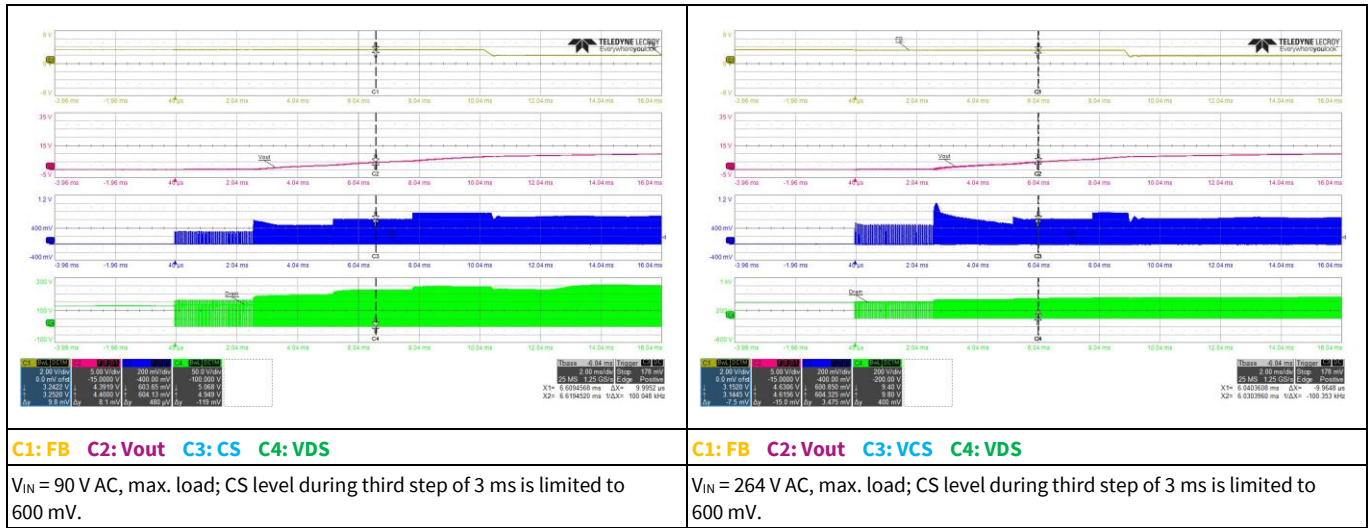
**Figure 20 Soft-start - second step**

# 15 W auxiliary SMPS for air conditioner using CoolSET™

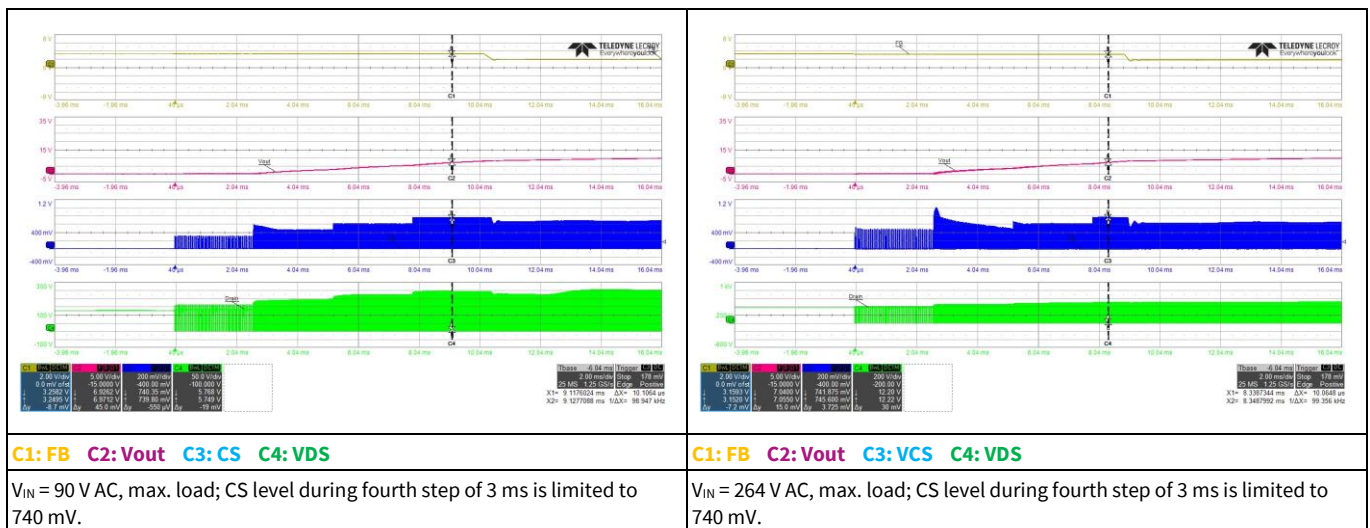
## ICE5AR4770BZS-1

REF\_5AR4770BZS-1\_15W1

### Waveforms

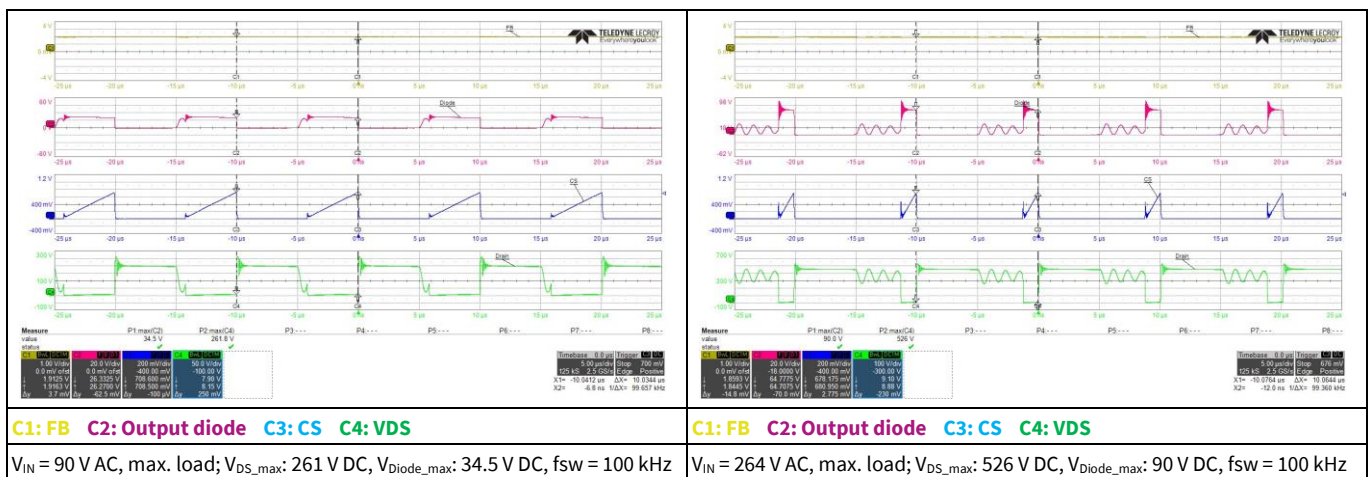


**Figure 21 Soft-start - third step**



**Figure 22 Soft-start- fourth step**

## 11.3 Switching waveform at maximum load



**Figure 23 Drain and CS voltage at maximum load**

# 15 W auxiliary SMPS for air conditioner using CoolSET™ ICE5AR4770BZS-1

REF\_5AR4770BZS-1\_15W1

## Waveforms

### 11.4 Frequency jittering and modulated gate drive

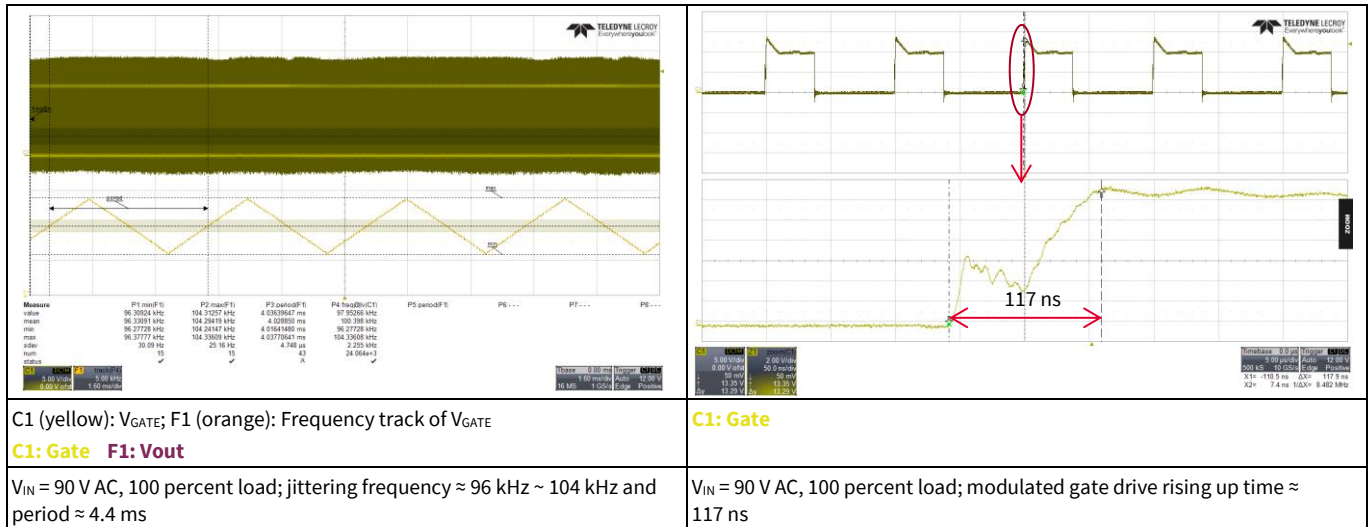


Figure 24 Frequency jittering and modulated gate drive

### 11.5 Output ripple voltage at maximum load

- Probe terminal end with decoupling capacitor of 0.1 μF (ceramic) and 10 μF (electrolytic), 20 MHz BW

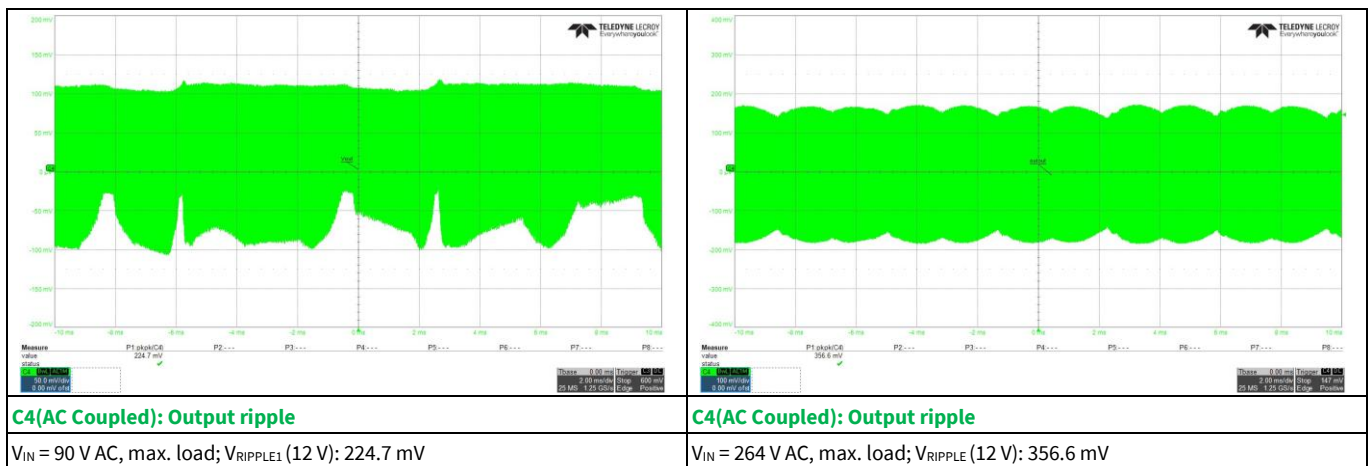


Figure 25 Output ripple voltage at maximum load

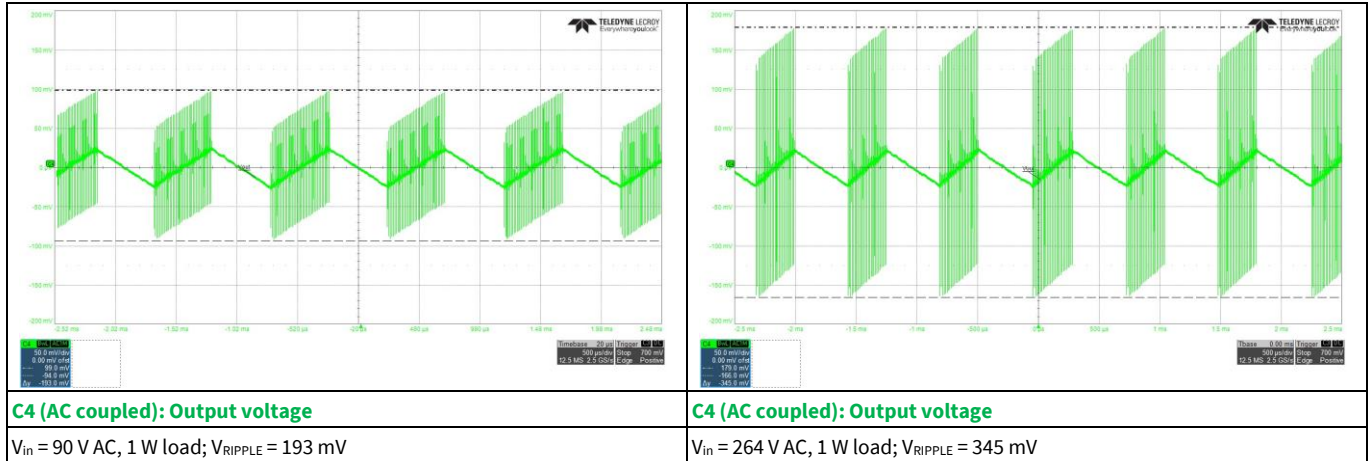
# 15 W auxiliary SMPS for air conditioner using CoolSET™ ICE5AR4770BZS-1

REF\_5AR4770BZS-1\_15W1

## Waveforms

### 11.6 Output ripple voltage in ABM 1W load

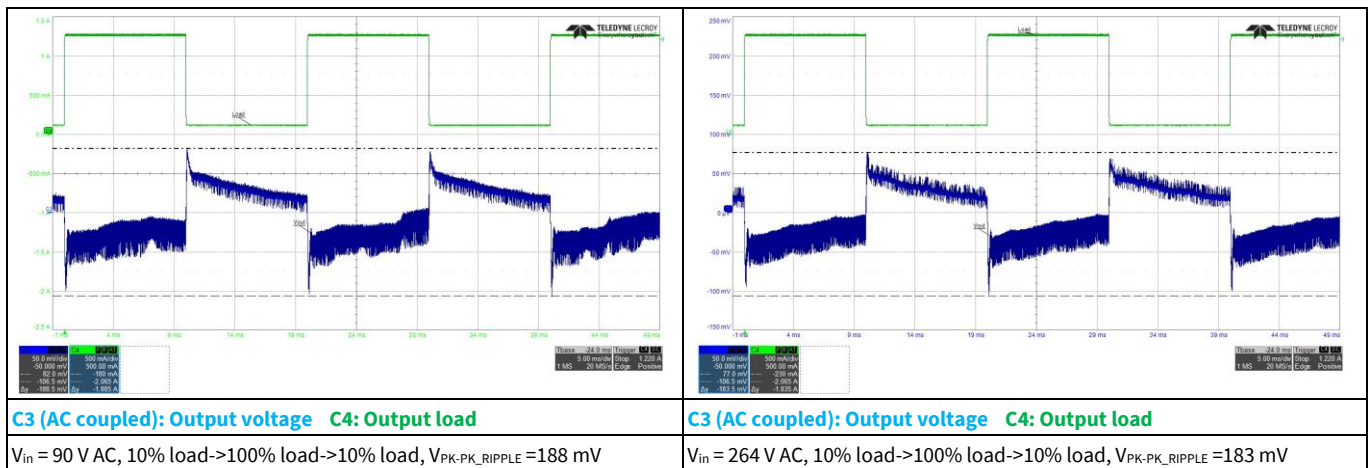
- Probe terminal end with decoupling capacitor of 0.1  $\mu\text{F}$  (ceramic) and 10  $\mu\text{F}$  (electrolytic), 20 MHz BW
- Load: 1 W (12 V, 83 mA)



**Figure 26** Output ripple voltage in ABM 1 W load

### 11.7 Load transient response (dynamic load from 10–100 percent)

- Probe terminal end with decoupling capacitor of 0.1  $\mu\text{F}$  (ceramic) and 10  $\mu\text{F}$  (electrolytic), 20 MHz BW
- Load cycling from 10 percent to 100 percent, 50% duty cycle, 100 Hz



**Figure 27** Load transient response

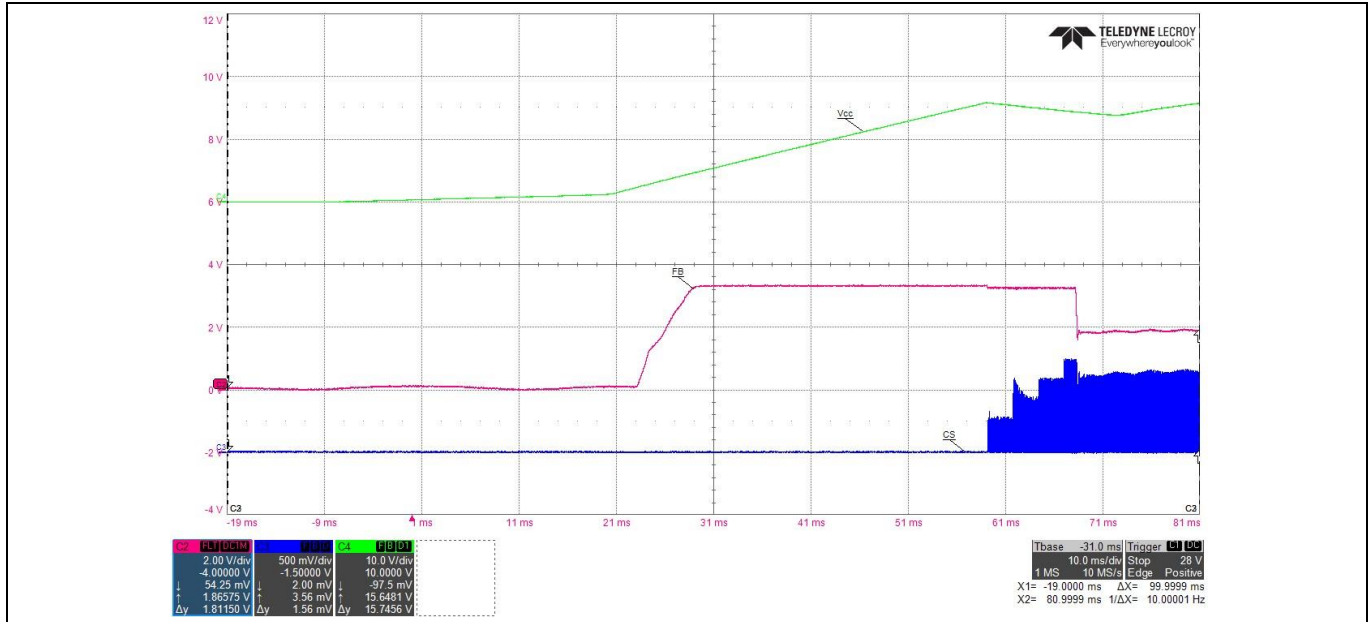
# 15 W auxiliary SMPS for air conditioner using CoolSET™ ICE5AR4770BZS-1

REF\_5AR4770BZS-1\_15W1

## Waveforms

### 11.8 Detection of ABM level

- Start up in full load



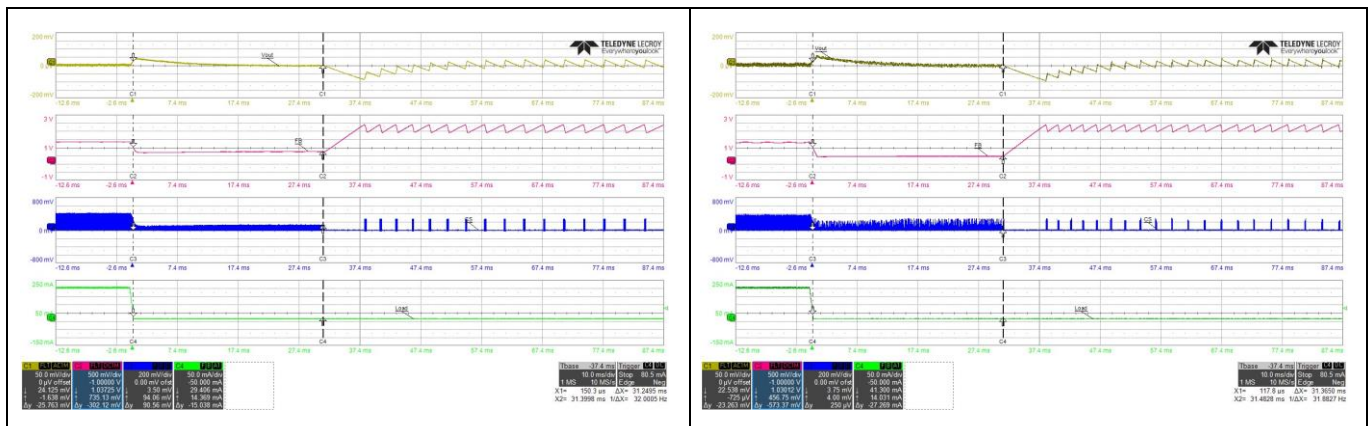
C2: FB C3: CS C4: VCC

$V_{IN} = 230\text{ V AC}$ ; The IC decides which level of ABM is selected based on the FB voltage level during startup when  $V_{cc}$  hits  $V_{VCC\_ON}(16\text{ V})$ . Since  $V_{FB} > V_{FB\_P\_BIAS2}(2.89\text{ V})$ , option 3 is selected where the part goes into ABM when the FB goes below  $V_{FB\_EBHP}(1.03\text{ V})$ .

Figure 28 Detection of ABM level

### 11.9 Entering ABM

- Load change from 3W (12 V, 250 mA) to 0.5 W (12 V, 0.041 A)



C1: Output voltage (AC coupled) C2: FB C3: CS C4: Output load

$V_{IN} = 90\text{ V AC}$ ; system enters burst mode option 3 when  $V_{FB}$  less than 1.03 V and  $t_{blinking} = 31.24\text{ ms}$

C1: Output voltage (AC coupled) C2: FB C3: CS C4: Output load

$V_{IN} = 264\text{ V AC}$ ; system enters burst mode option 3 when  $V_{FB}$  less than 1.03 V and  $t_{blinking} = 31.36\text{ ms}$

Figure 29 Entering ABM

# 15 W auxiliary SMPS for air conditioner using CoolSET™

## ICE5AR4770BZS-1

REF\_5AR4770BZS-1\_15W1

### Waveforms

#### 11.10 During ABM

- Load: 0.5 W (12 V, 0.041 A)

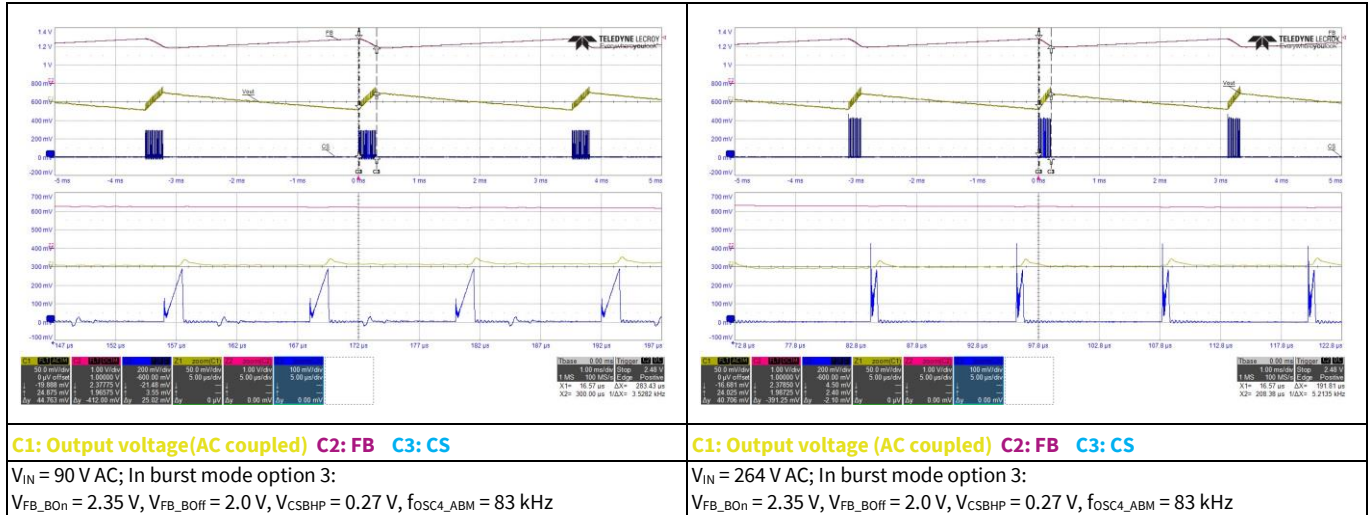


Figure 30 During ABM

#### 11.11 Leaving ABM

- Load change from 0.5 W (12 V, 0.041 A) to 3 W (12 V, 0.250 mA)

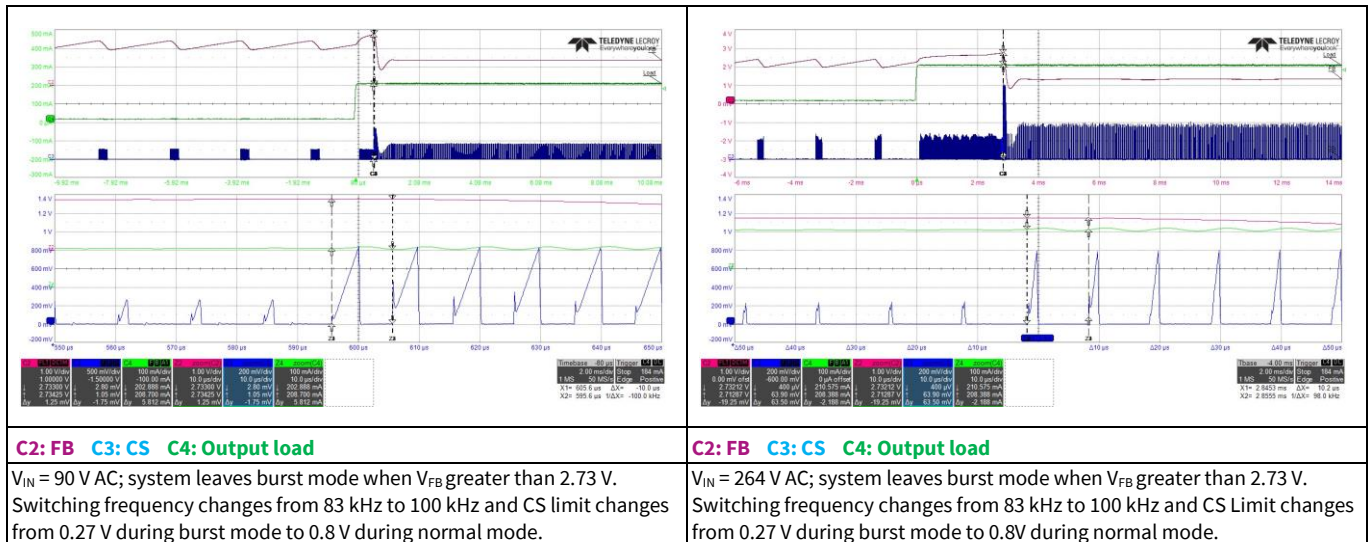


Figure 31 Leaving ABM

# 15 W auxiliary SMPS for air conditioner using CoolSET™

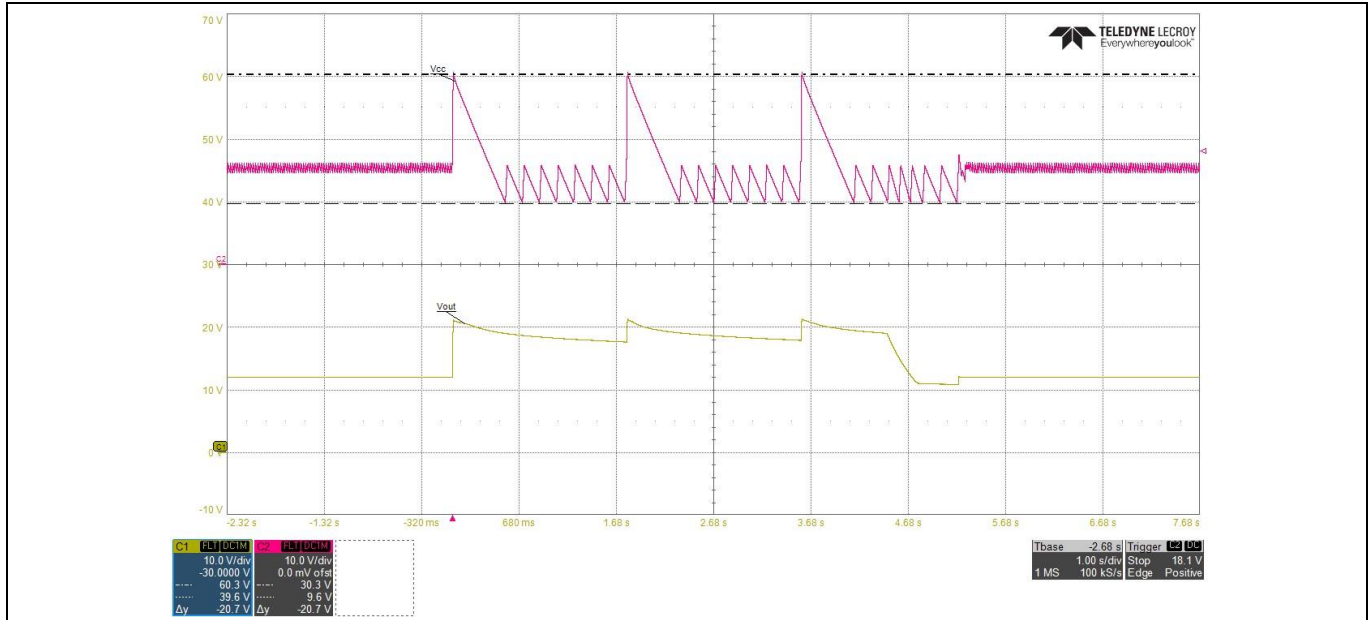
## ICE5AR4770BZS-1

REF\_5AR4770BZS-1\_15W1

### Waveforms

## 11.12 Output overvoltage by utilizing V<sub>CC</sub> OVP

- Short R26 resistor during system operation at no load



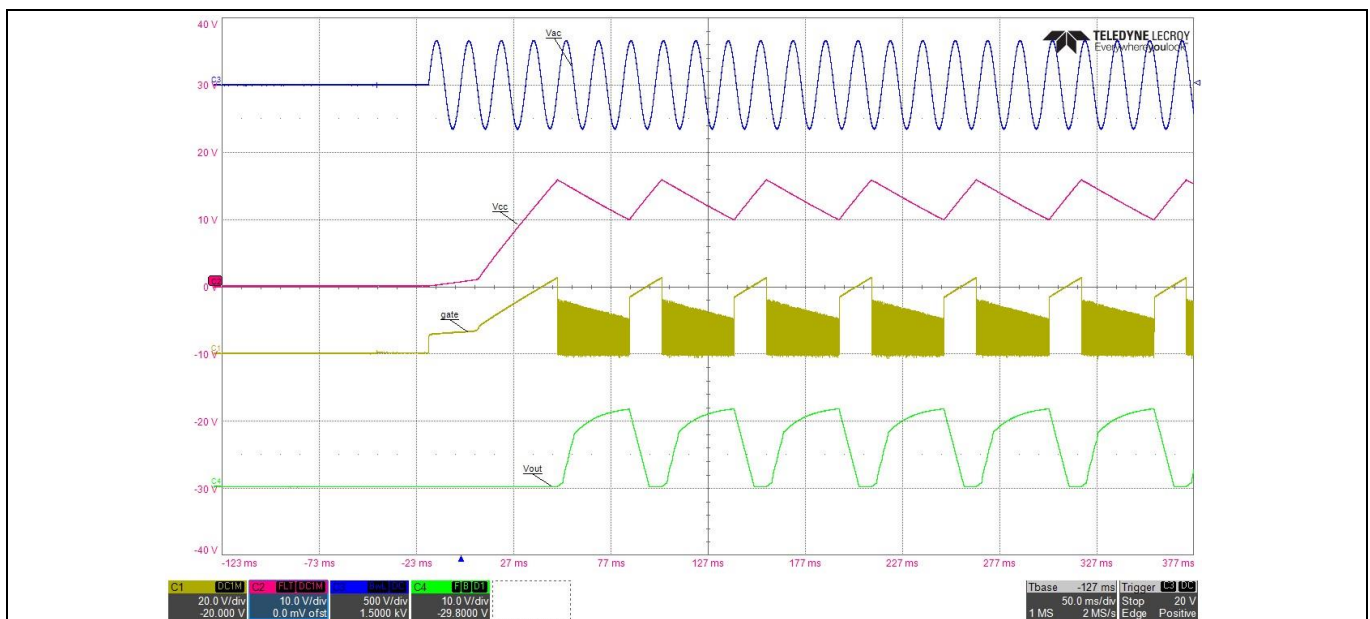
C1: Output voltage C2: VCC

V<sub>IN</sub> = 90 V AC; system enters output OVP by using V<sub>CC</sub> OVP. Shorting R26 during running operation causes the converter to deliver more energy to the output than the load demand. This leads to output overshoot which in turn causes the V<sub>CC</sub> to hit V<sub>CC</sub> OVP threshold (30.5 V) and trigger extended cycle skip auto-restart protection.

Figure 32 V<sub>CC</sub> OVP

## 11.13 V<sub>CC</sub> undervoltage (auto restart)

- Remove R12A and power on the system with full load.



C1: Gate C2: VCC C3: VAC C4: Output voltage

V<sub>IN</sub> = 230 V AC; since the connection from the auxiliary winding is removed, the V<sub>CC</sub> does not get enough energy and droops to V<sub>VCC\_UVLO</sub> = 10 V triggering an auto-restart protection.

Figure 33 V<sub>CC</sub> undervoltage



# 15 W auxiliary SMPS for air conditioner using CoolSET™

## ICE5AR4770BZS-1

REF\_5AR4770BZS-1\_15W1

### Waveforms

#### 11.14 Over-load protection

- Change output load from 1.25A to 3A.

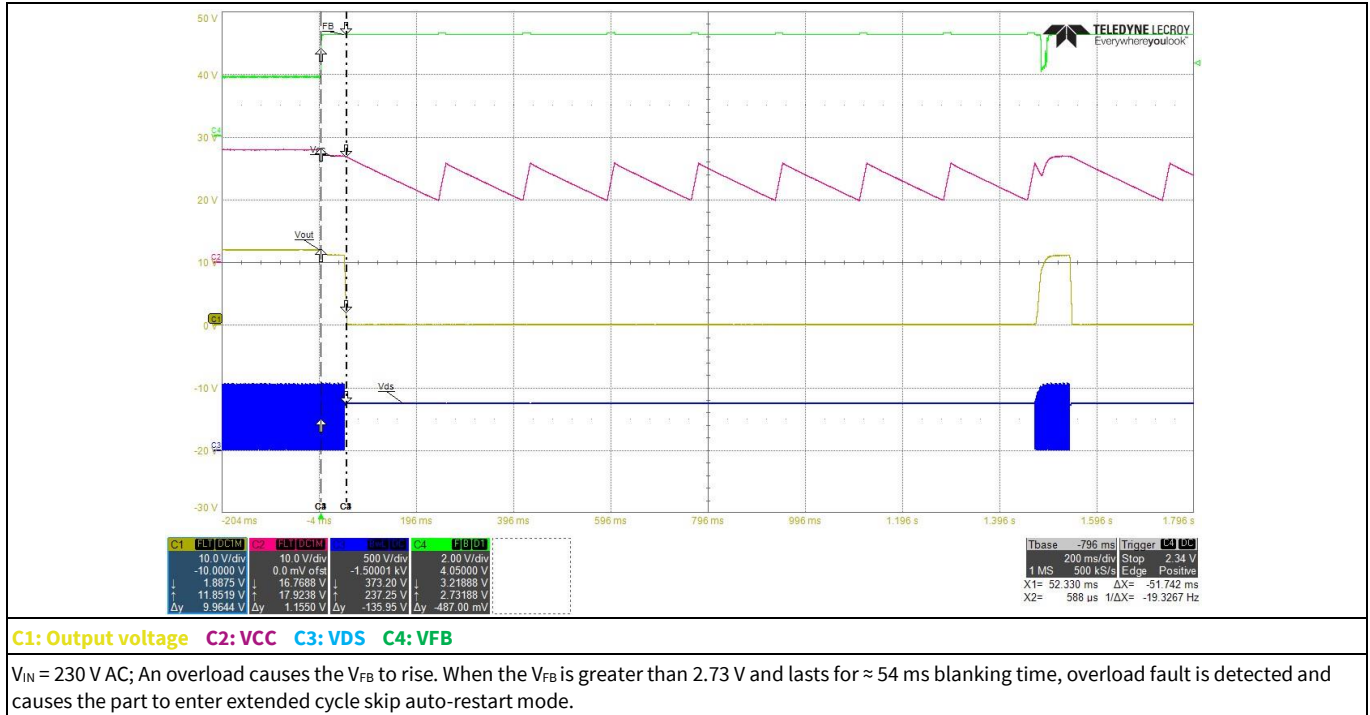


Figure 34 Over-load protection

#### 11.15 $V_{CC}$ short-to-GND protection

- Short  $V_{CC}$  pin-to-GND with current meter before system start-up

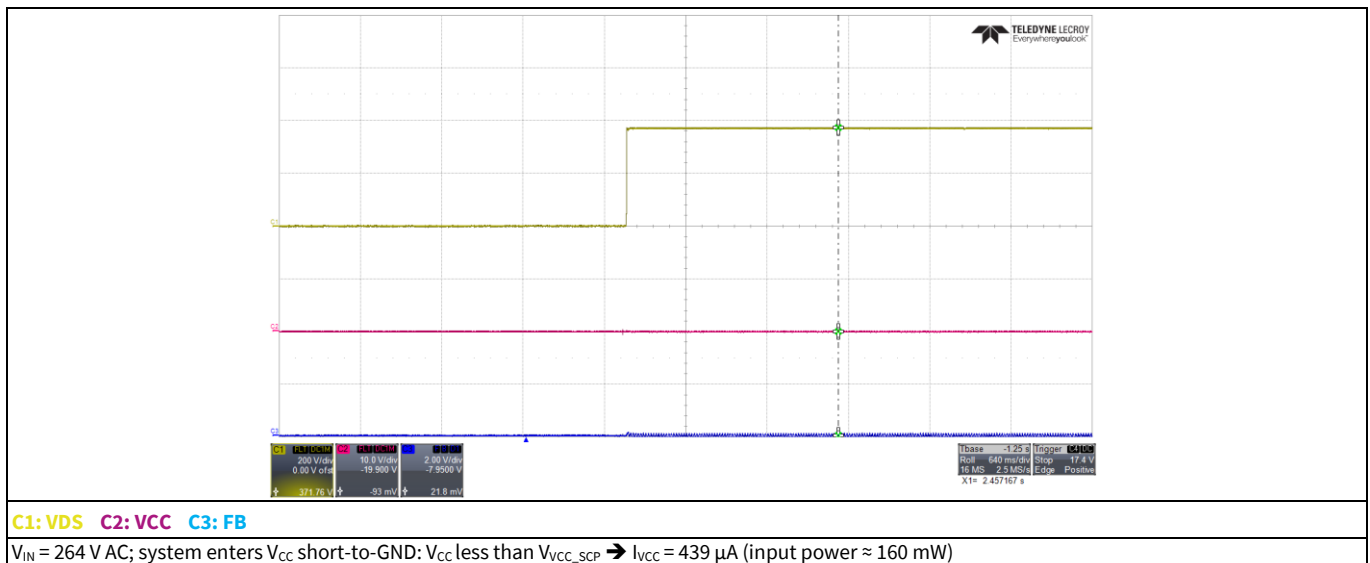


Figure 35  $V_{CC}$  short-to-GND protection

# 15 W auxiliary SMPS for air conditioner using CoolSET™ ICE5AR4770BZS-1

REF\_5AR4770BZS-1\_15W1

Conducted emissions (EN 55022 Class-B)

## 12 Conducted emissions (EN 55022 Class-B)

Equipment: Schaffner SMR4503 (receiver); standard: EN 55022 (CISPR 22) Class-B; test conditions:  $V_{IN} = 115\text{ V AC}$ , and  $220\text{ V AC}$ , load:  $15\text{ W}$  ( $12\text{ V } 9.6\ \Omega$ ).

- Pass conducted emissions EN 55022 (CISPR 22) Class-B at low-line ( $115\text{ V AC}$ ) and high-line ( $220\text{ V AC}$ ).

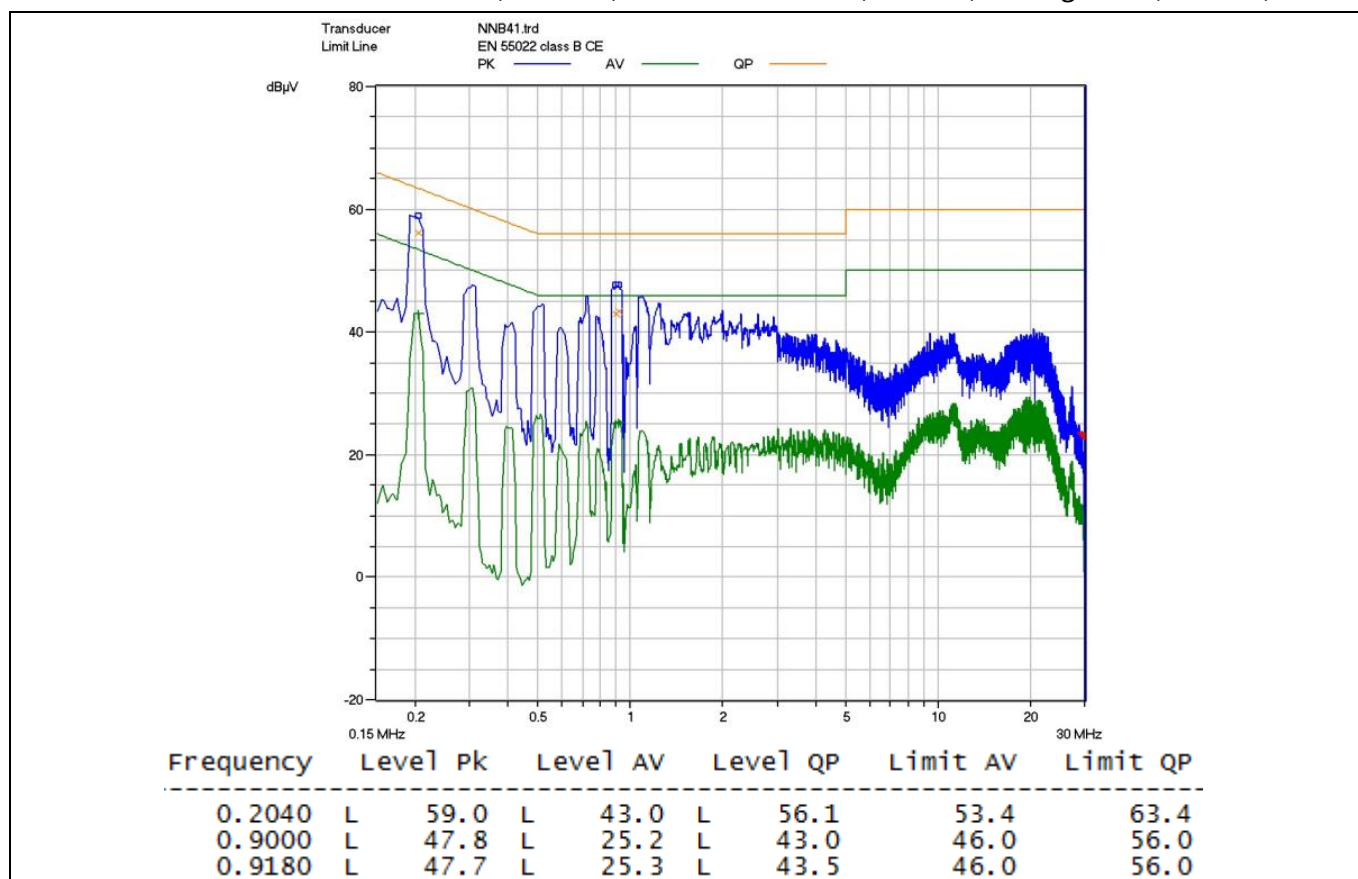


Figure 36 Conducted emissions at 115 V AC-line and 15 W load – greater than 7 dB margin

# 15 W auxiliary SMPS for air conditioner using CoolSET™ ICE5AR4770BZS-1

REF\_5AR4770BZS-1\_15W1

Conducted emissions (EN 55022 Class-B)

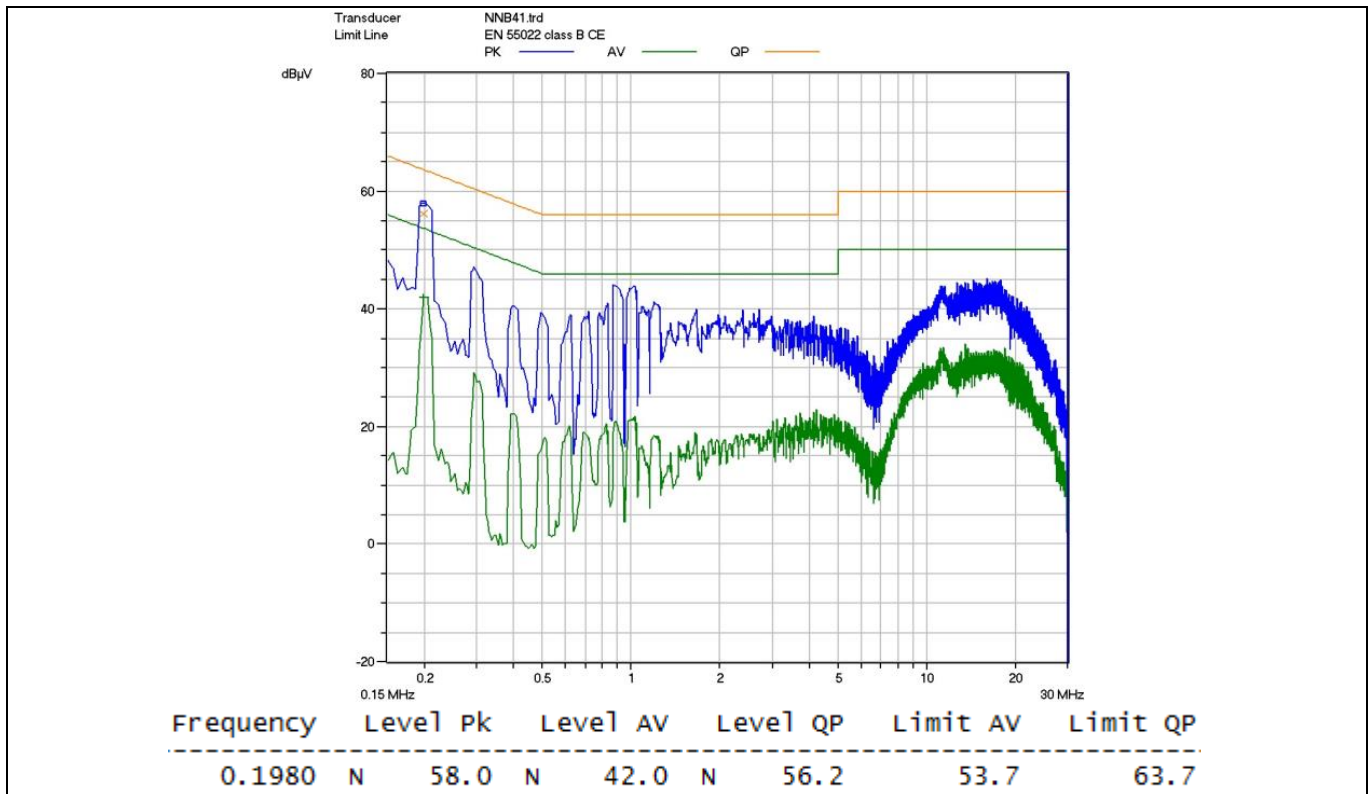


Figure 37 Conducted emissions at 115 V AC-neutral and 15 W load – greater than 7 dB margin

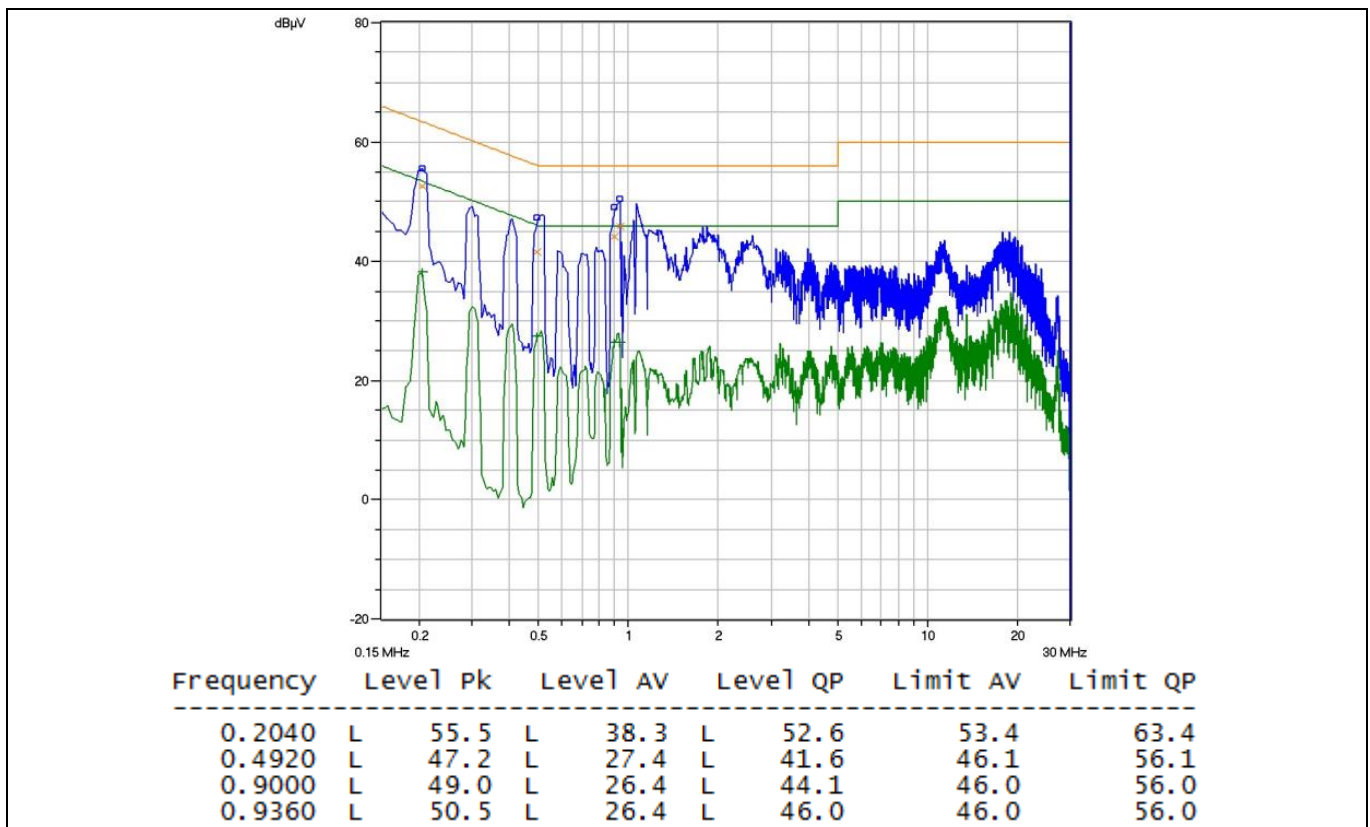
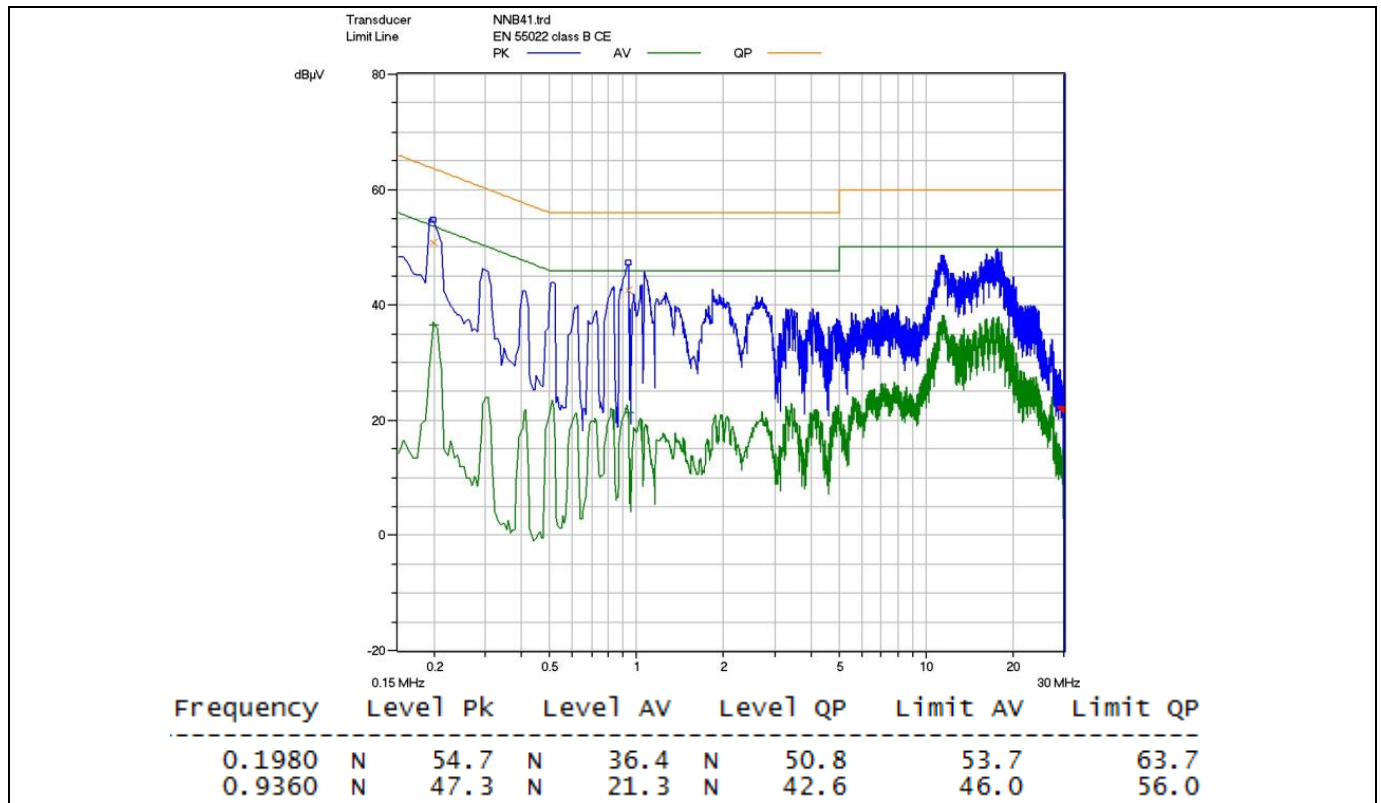


Figure 38 Conducted emissions at 220 V AC-line and 15 W load – greater than 10 dB margin

# 15 W auxiliary SMPS for air conditioner using CoolSET™ ICE5AR4770BZS-1

REF\_5AR4770BZS-1\_15W1

Conducted emissions (EN 55022 Class-B)



**Figure 39** Conducted emissions at 220 V AC-neutral and 15 W load – greater than 12 dB margin

# 15 W auxiliary SMPS for air conditioner using CoolSET™ ICE5AR4770BZS-1

REF\_5AR4770BZS-1\_15W1

ESD immunity (EN 61000-4-2)

## 13 ESD immunity (EN 61000-4-2)

This system is subjected to a  $\pm 8$  kV ESD test according to EN 61000-4-2 for both contact and air discharge. A test failure is defined as non-recoverable.

- Air discharge: pass  $\pm 8$  kV; contact discharge: pass  $\pm 8$  kV.

**Table 7 System ESD test result**

Description	ESD test	Level	Number of strikes		Test result
			+V <sub>OUT</sub>	-V <sub>OUT</sub>	
115 V AC, 15 W (12 V 9.6 $\Omega$ )	Contact	+8 kV	10	10	PASS
		-8 kV	10	10	PASS
	Air	+8 kV	10	10	PASS
		-8 kV	10	10	PASS
220 V AC, 15 W (12 V 9.6 $\Omega$ )	Contact	+8 kV	10	10	PASS
		-8 kV	10	10	PASS
	Air	+8 kV	10	10	PASS
		-8 kV	10	10	PASS

## 14 Surge immunity (EN 61000-4-5)

This system is subjected to a surge immunity test ( $\pm 2$  kV differential mode and  $\pm 4$  kV common mode) according to EN 61000-4-5. A test failure is defined as a non-recoverable.

- DM: pass  $\pm 2$  kV; CM: pass  $\pm 4$  kV.

**Table 8 System surge immunity test result**

Description	Surge type	Level		Number of strikes				Test result
				0°	90°	180°	270°	
115 V AC, 15 W (12 V 9.6 $\Omega$ )	Differential mode	+2 kV	L $\rightarrow$ N	3	3	3	3	PASS
		-2 kV	L $\rightarrow$ N	3	3	3	3	PASS
	Common mode	+4 kV	L $\rightarrow$ G	3	3	3	3	PASS
		+4 kV	N $\rightarrow$ G	3	3	3	3	PASS
		-4 kV	L $\rightarrow$ G	3	3	3	3	PASS
		-4 kV	N $\rightarrow$ G	3	3	3	3	PASS
220 V AC, 15 W (12 V 9.6 $\Omega$ )	Differential mode	+2 kV	L $\rightarrow$ N	3	3	3	3	PASS
		-2 kV	L $\rightarrow$ N	3	3	3	3	PASS
	Common mode	+4 kV	L $\rightarrow$ G	3	3	3	3	PASS
		+4 kV	N $\rightarrow$ G	3	3	3	3	PASS
		-4 kV	L $\rightarrow$ G	3	3	3	3	PASS
		-4 kV	N $\rightarrow$ G	3	3	3	3	PASS

# 15 W auxiliary SMPS for air conditioner using CoolSET™ ICE5AR4770BZS-1

REF\_5AR4770BZS-1\_15W1

## Appendix A: WE transformer specification

### 15 Appendix A: WE transformer specification

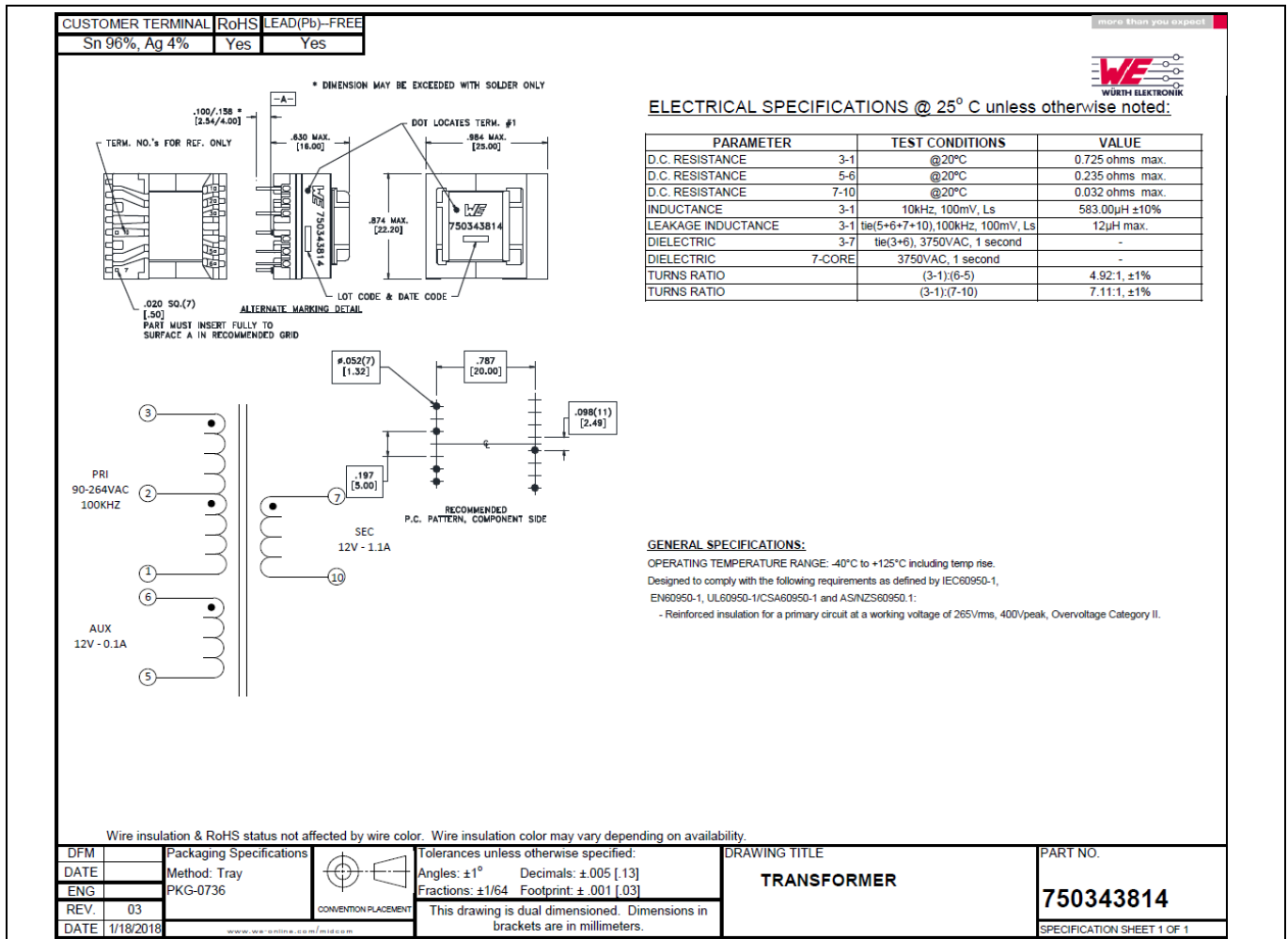


Figure 40 WE transformer specification

# 15 W auxiliary SMPS for air conditioner using CoolSET™ ICE5AR4770BZS-1



REF\_5AR4770BZS-1\_15W1

---

## References

## References

- [1] Infineon Technologies AG: *ICE5xRxxxxBZx-1 datasheet*; [Available online](#)
- [2] Infineon Technologies AG: *CoolSET™ 5<sup>th</sup> Generation Fixed Frequency Plus flyback design guide*; [Available online](#)
- [3] Infineon Technologies AG: *CoolSET™ 5<sup>th</sup> Generation Fixed Frequency Plus calculation tool for flyback*; [Available online](#)



## 15 W auxiliary SMPS for air conditioner using CoolSET™

### ICE5AR4770BZS-1

---

REF\_5AR4770BZS-1\_15W1

Design support

## Design support

### Developer community

For a wider discussion with peers from industry to trade ideas regarding Infineon products, we welcome you to actively participate on the [Infineon Developer Community](#).

### Technical support

Have technical queries? Consult experts from Infineon to get a fast turn-around by raising a request on the [Technical Support](#) page or a [local sales representative](#).

**15 W auxiliary SMPS for air conditioner using CoolSET™  
ICE5AR4770BZS-1**



REF\_5AR4770BZS-1\_15W1

**Revision history**

**Revision history**

<b>Document revision</b>	<b>Date</b>	<b>Description of changes</b>
V 1.0	2024-08-23	Initial release

#### **Trademarks**

All referenced product or service names and trademarks are the property of their respective owners.

**Edition 2024-08-23**

**Published by**

**Infineon Technologies AG**

**81726 Munich, Germany**

**© 2024 Infineon Technologies AG.  
All Rights Reserved.**

**Do you have a question about this document?**

**Email:** [erratum@infineon.com](mailto:erratum@infineon.com)

**Document reference**

**AN032404**

#### **Important notice**

The information contained in this application note is given as a hint for the implementation of the product only and shall in no event be regarded as a description or warranty of a certain functionality, condition or quality of the product. Before implementation of the product, the recipient of this application note must verify any function and other technical information given herein in the real application. Infineon Technologies hereby disclaims any and all warranties and liabilities of any kind (including without limitation warranties of non-infringement of intellectual property rights of any third party) with respect to any and all information given in this application note.

The data contained in this document is exclusively intended for technically trained staff. It is the responsibility of customer's technical departments to evaluate the suitability of the product for the intended application and the completeness of the product information given in this document with respect to such application.

#### **Warnings**

Due to technical requirements products may contain dangerous substances. For information on the types in question please contact your nearest Infineon Technologies office.

Except as otherwise explicitly approved by Infineon Technologies in a written document signed by authorized representatives of Infineon Technologies, Infineon Technologies' products may not be used in any applications where a failure of the product or any consequences of the use thereof can reasonably be expected to result in personal injury.

## X-ON Electronics

Largest Supplier of Electrical and Electronic Components

*Click to view similar products for [Power Management IC Development Tools](#) category:*

*Click to view products by [Infineon](#) manufacturer:*

Other Similar products are found below :

[EVB-EP5348UI](#) [BQ25010EVM](#) [ISL80019AEVAL1Z](#) [ISLUSBI2CKIT1Z](#) [ISL8002AEVAL1Z](#) [ISL91108IIA-EVZ](#) [ISL28022EVKIT1Z](#)  
[STEVAL-ISA008V1](#) [DRI0043](#) [KITPF8100FRDMEVM](#) [NCP10671B05GEVB](#) [EVB-EN6337QA](#) [SAMPLEBOXILD8150TOBO1](#)  
[AP62300WU-EVM](#) [KITA2GTC387MOTORCTRTOBO1](#) [AEK-MOT-TK200G1](#) [EVLONE65W](#) [STEVAL-ILH006V1](#) [STEVAL-IPE008V2](#)  
[STEVAL-IPP001V2](#) [STEVAL-ISA013V1](#) [STEVAL-ISA067V1](#) [STEVAL-ISQ002V1](#) [TPS2306EVM-001](#) [TPS2330EVM-185](#)  
[TPS40001EVM-001](#) [SECO-HVDCDC1362-15W-GEVB](#) [BTS7030-2EPA](#) [LT8638SJV#WPBF](#) [LTC3308AIV#WTRPBF](#) [TLT807B0EPV](#)  
[BTS71033-6ESA](#) [EV13N91A](#) [EASYPIC V8 OVER USB-C](#) [EV55W64A](#) [CLICKER 4 FOR STM32F4](#) [EASYMX PRO V7A FOR STM32](#)  
[CLICKER 4 FOR PIC18F](#) [Si8285\\_86v2-KIT](#) [NCP-NCV51752D2PAK3LGEVB](#) [ISL81807EVAL1Z](#) [EVALM7HVIGBTTPFCINV4TOBO1](#)  
[903-0300-000](#) [902-0173-000](#) [903-0301-000](#) [ROA1286023/1](#) [REFSHA35IMD111TSYSTOBO1](#) [150037482](#) [SABMB629](#) [TDINV3000W50B-](#)  
[KIT](#)