

Fast IGBT in NPT-technology with soft, fast recovery anti-parallel Emitter Controlled Diode

- 40% lower E_{off} compared to previous generation
- Short circuit withstand time – 10 μ s
- Designed for:
 - Motor controls
 - Inverter
 - SMPS
- NPT-Technology offers:
 - very tight parameter distribution
 - high ruggedness, temperature stable behaviour
 - parallel switching capability
- Pb-free lead plating; RoHS compliant
- Qualified according to JEDEC¹ for target applications
- Complete product spectrum and PSpice Models : <http://www.infineon.com/igbt/>

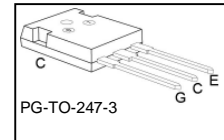
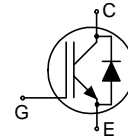

Type	V_{CE}	I_C	E_{off}	T_j	Marking	Package
SKW25N120	1200V	25A	2.9mJ	150°C	K25N120	PG-TO-247-3

Maximum Ratings

Parameter	Symbol	Value	Unit
Collector-emitter voltage	V_{CE}	1200	V
DC collector current	I_C		A
$T_C = 25^\circ\text{C}$		46	
$T_C = 100^\circ\text{C}$		25	
Pulsed collector current, t_p limited by T_{jmax}	I_{Cpuls}	84	
Turn off safe operating area $V_{CE} \leq 1200\text{V}, T_j \leq 150^\circ\text{C}$	-	84	
Diode forward current	I_F		
$T_C = 25^\circ\text{C}$		42	
$T_C = 100^\circ\text{C}$		25	
Diode pulsed current, t_p limited by T_{jmax}	I_{Fpuls}	80	
Gate-emitter voltage	V_{GE}	± 20	V
Short circuit withstand time ² $V_{GE} = 15\text{V}, 100\text{V} \leq V_{CC} \leq 1200\text{V}, T_j \leq 150^\circ\text{C}$	t_{SC}	10	μ s
Power dissipation $T_C = 25^\circ\text{C}$	P_{tot}	313	W
Operating junction and storage temperature	T_j, T_{stg}	-55...+150	°C
Soldering temperature, wavesoldering, 1.6mm (0.063 in.) from case for 10s	T_s	260	

¹ J-STD-020 and JESD-022

² Allowed number of short circuits: <1000; time between short circuits: >1s.

Thermal Resistance

Parameter	Symbol	Conditions	Max. Value	Unit
Characteristic				
IGBT thermal resistance, junction – case	R_{thJC}		0.4	K/W
Diode thermal resistance, junction – case	R_{thJCD}		1.15	
Thermal resistance, junction – ambient	R_{thJA}		40	

Electrical Characteristic, at $T_j = 25\text{ }^\circ\text{C}$, unless otherwise specified

Parameter	Symbol	Conditions	Value			Unit
			min.	typ.	max.	
Static Characteristic						
Collector-emitter breakdown voltage	$V_{(BR)CES}$	$V_{GE}=0V,$ $I_C=1500\mu A$	1200	-	-	V
Collector-emitter saturation voltage	$V_{CE(sat)}$	$V_{GE} = 15V, I_C=25A$ $T_j=25^\circ C$ $T_j=150^\circ C$	2.5 -	3.1 3.7	3.6 4.3	
Diode forward voltage	V_F	$V_{GE}=0V, I_F=25A$ $T_j=25^\circ C$ $T_j=150^\circ C$	-	2.0 1.75	2.5	
Gate-emitter threshold voltage	$V_{GE(th)}$	$I_C=1000\mu A,$ $V_{CE}=V_{GE}$	3	4	5	
Zero gate voltage collector current	I_{CES}	$V_{CE}=1200V, V_{GE}=0V$ $T_j=25^\circ C$ $T_j=150^\circ C$	- -	- -	350 1400	μA
Gate-emitter leakage current	I_{GES}	$V_{CE}=0V, V_{GE}=20V$	-	-	100	nA
Transconductance	g_{fs}	$V_{CE}=20V, I_C=25A$	-	20	-	S
Dynamic Characteristic						
Input capacitance	C_{iss}	$V_{CE}=25V,$ $V_{GE}=0V,$ $f=1MHz$	-	2150	2600	pF
Output capacitance	C_{oss}		-	260	310	
Reverse transfer capacitance	C_{riss}		-	110	130	
Gate charge	Q_{Gate}	$V_{CC}=960V, I_C=25A$ $V_{GE}=15V$	-	225	300	nC
Internal emitter inductance Measured 5mm (0.197 in.) from case	L_E		-	13	-	nH
Short circuit collector current ¹⁾	$I_{C(SC)}$	$V_{GE}=15V, t_{SC}\leq 10\mu s$ $100V\leq V_{CC}\leq 1200V,$ $T_j\leq 150^\circ C$	-	240	-	A

¹⁾ Allowed number of short circuits: <1000; time between short circuits: >1s

Switching Characteristic, Inductive Load, at $T_j=25^\circ\text{C}$

Parameter	Symbol	Conditions	Value			Unit
			Min.	typ.	max.	
IGBT Characteristic						
Turn-on delay time	$t_{d(on)}$	$T_j=25^\circ\text{C}$, $V_{CC}=800\text{V}$, $I_C=25\text{A}$, $V_{GE}=15/0\text{V}$, $R_G=22\Omega$, $L_{\sigma}^{(1)}=180\text{nH}$, $C_{\sigma}^{(1)}=40\text{pF}$ Energy losses include "tail" and diode reverse recovery.	-	45	60	ns
Rise time	t_r		-	40	52	
Turn-off delay time	$t_{d(off)}$		-	730	950	
Fall time	t_f		-	30	39	
Turn-on energy	E_{on}		-	2.2	2.9	mJ
Turn-off energy	E_{off}		-	1.5	2.0	
Total switching energy	E_{ts}		-	3.7	4.9	

Anti-Parallel Diode Characteristic

Diode reverse recovery time	t_{rr}	$T_j=25^\circ\text{C}$, $V_R=800\text{V}$, $I_F=25\text{A}$, $di_F/dt=650\text{A}/\mu\text{s}$	-	90		ns
	t_S		-			
	t_F		-			
Diode reverse recovery charge	Q_{rr}		-	1.0		μC
Diode peak reverse recovery current	I_{rrm}		-	20		A
Diode peak rate of fall of reverse recovery current during t_F	di_{rr}/dt	-	470		$\text{A}/\mu\text{s}$	

Switching Characteristic, Inductive Load, at $T_j=150^\circ\text{C}$

Parameter	Symbol	Conditions	Value			Unit
			Min.	typ.	max.	
IGBT Characteristic						
Turn-on delay time	$t_{d(on)}$	$T_j=150^\circ\text{C}$ $V_{CC}=800\text{V}$, $I_C=25\text{A}$, $V_{GE}=15/0\text{V}$, $R_G=22\Omega$, $L_{\sigma}^{(1)}=180\text{nH}$, $C_{\sigma}^{(1)}=40\text{pF}$ Energy losses include "tail" and diode reverse recovery.	-	50	60	ns
Rise time	t_r		-	36	43	
Turn-off delay time	$t_{d(off)}$		-	820	990	
Fall time	t_f		-	42	50	
Turn-on energy	E_{on}		-	3.8	4.6	mJ
Turn-off energy	E_{off}		-	2.9	3.8	
Total switching energy	E_{ts}		-	6.7	8.4	

Anti-Parallel Diode Characteristic

Diode reverse recovery time	t_{rr}	$T_j=150^\circ\text{C}$ $V_R=800\text{V}$, $I_F=25\text{A}$, $di_F/dt=750\text{A}/\mu\text{s}$	-	280		ns
	t_S		-			
	t_F		-			
Diode reverse recovery charge	Q_{rr}		-	4.3		μC
Diode peak reverse recovery current	I_{rrm}		-	32		A
Diode peak rate of fall of reverse recovery current during t_F	di_{rr}/dt	-	130		$\text{A}/\mu\text{s}$	

¹⁾ Leakage inductance L_{σ} and stray capacity C_{σ} due to dynamic test circuit in figure E.

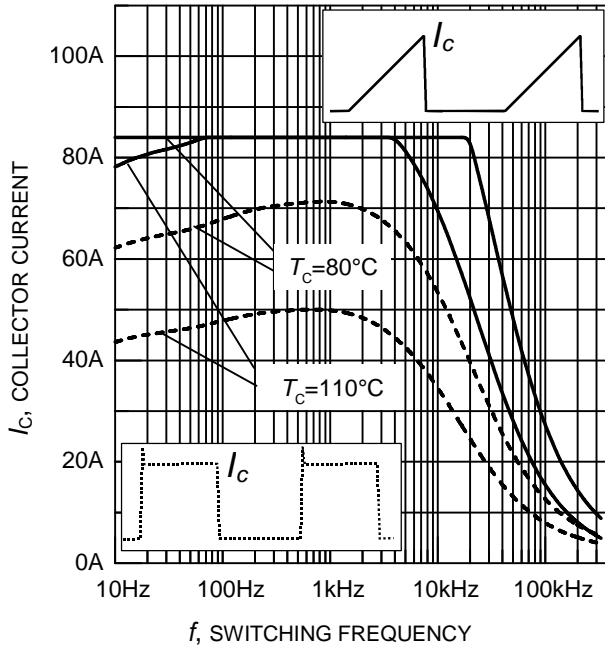

Figure 1. Collector current as a function of switching frequency

($T_j \leq 150^\circ\text{C}$, $D = 0.5$, $V_{CE} = 800\text{V}$, $V_{GE} = +15\text{V}/0\text{V}$, $R_G = 22\Omega$)

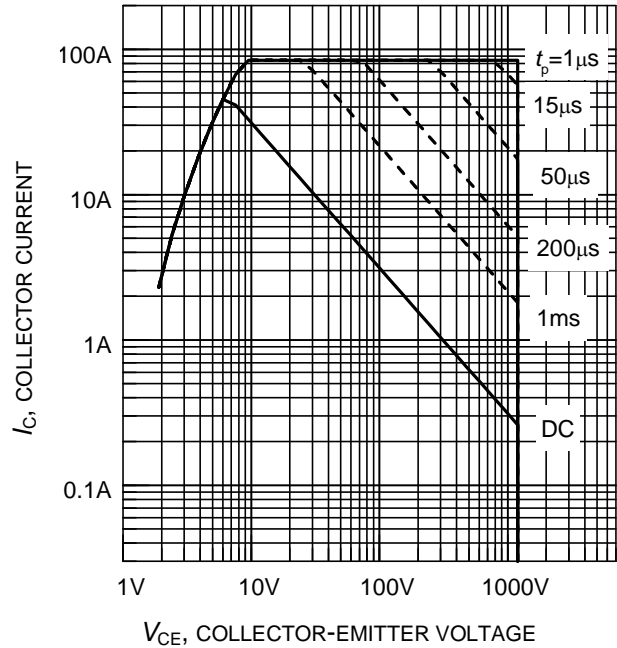

Figure 2. Safe operating area

($D = 0$, $T_C = 25^\circ\text{C}$, $T_j \leq 150^\circ\text{C}$)

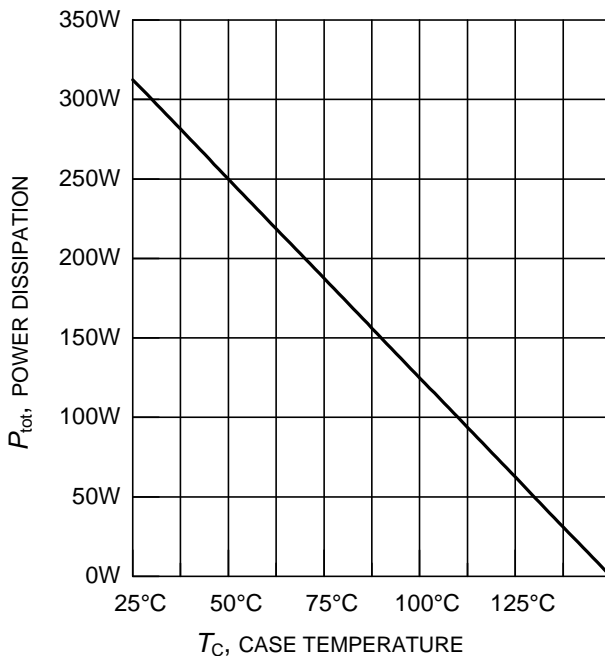

Figure 3. Power dissipation as a function of case temperature

($T_j \leq 150^\circ\text{C}$)

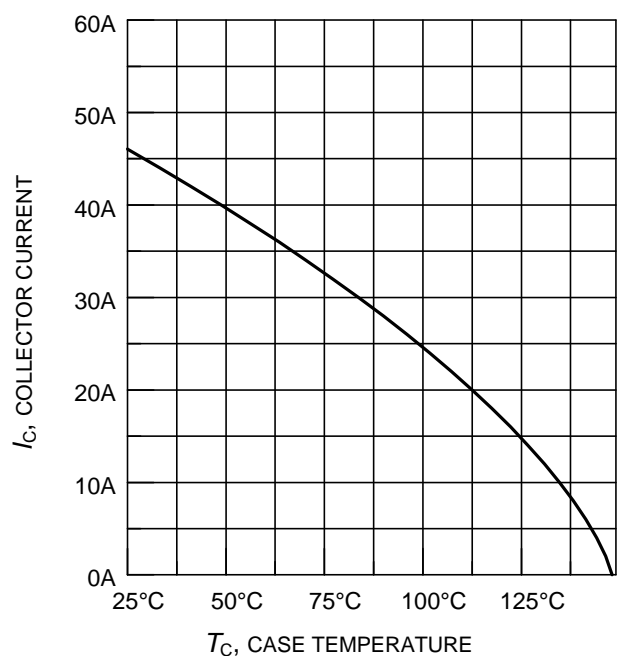

Figure 4. Collector current as a function of case temperature

($V_{GE} \leq 15\text{V}$, $T_j \leq 150^\circ\text{C}$)

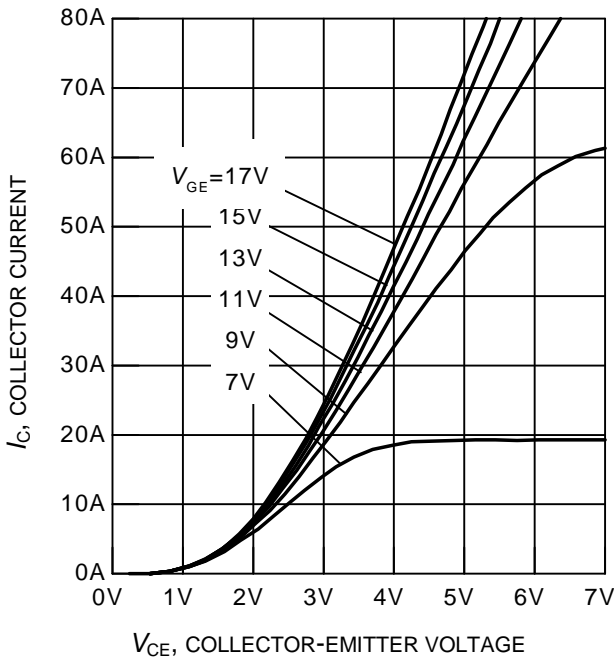

Figure 5. Typical output characteristics
($T_j = 25^\circ\text{C}$)

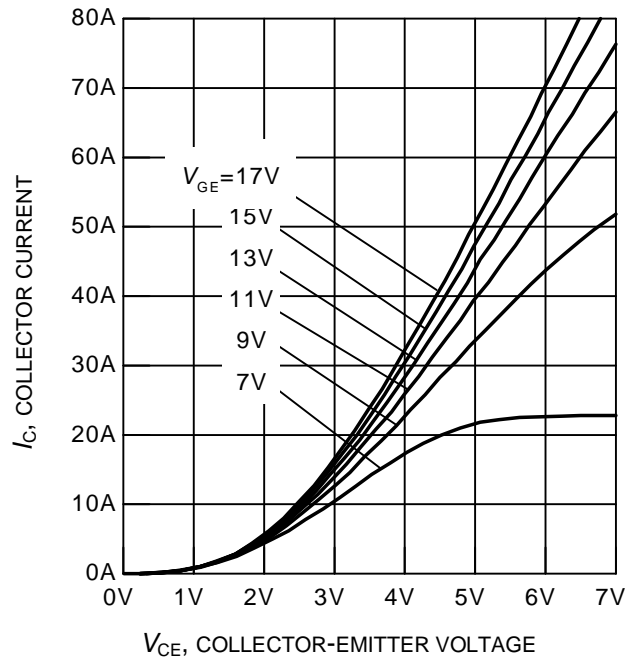

Figure 6. Typical output characteristics
($T_j = 150^\circ\text{C}$)

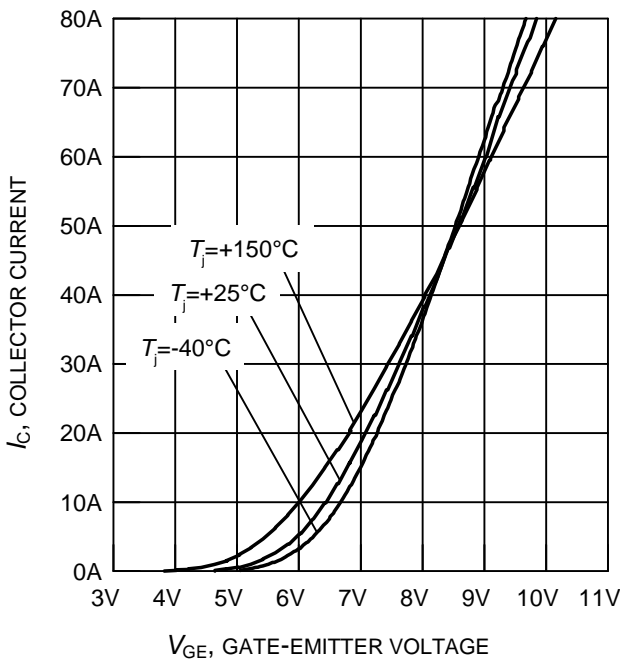

Figure 7. Typical transfer characteristics
($V_{CE} = 20\text{V}$)

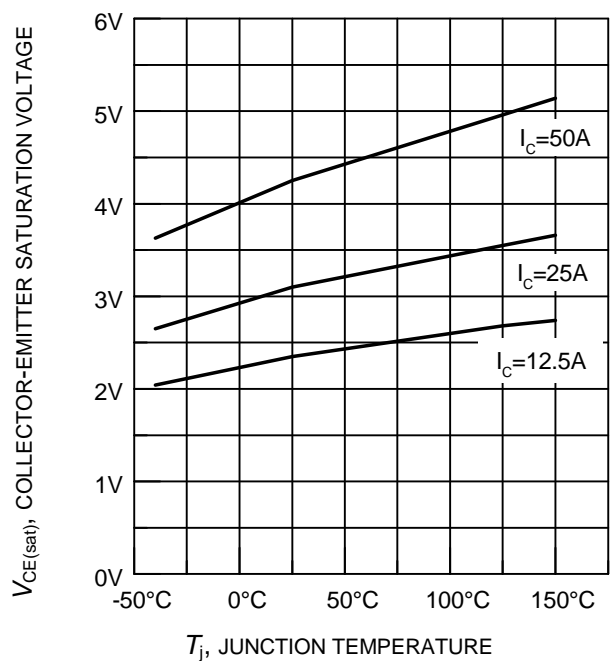

Figure 8. Typical collector-emitter saturation voltage as a function of junction temperature
($V_{GE} = 15\text{V}$)

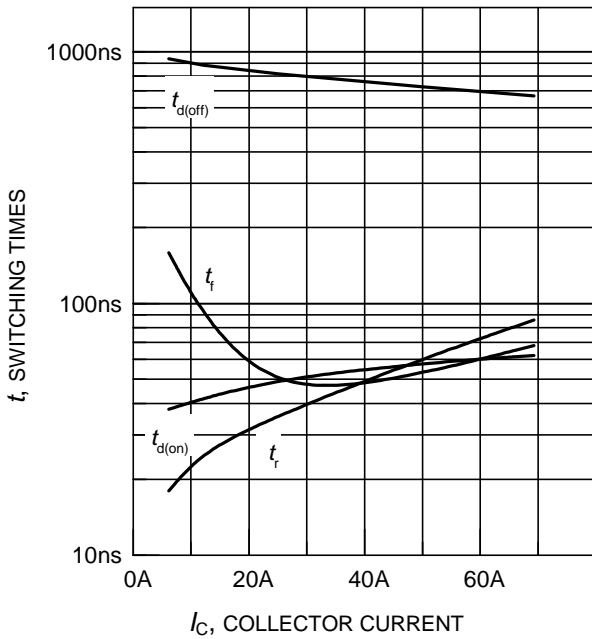

Figure 9. Typical switching times as a function of collector current
 (inductive load, $T_j = 150^\circ\text{C}$,
 $V_{CE} = 800\text{V}$, $V_{GE} = +15\text{V}/0\text{V}$, $R_G = 22\Omega$,
 dynamic test circuit in Fig.E)

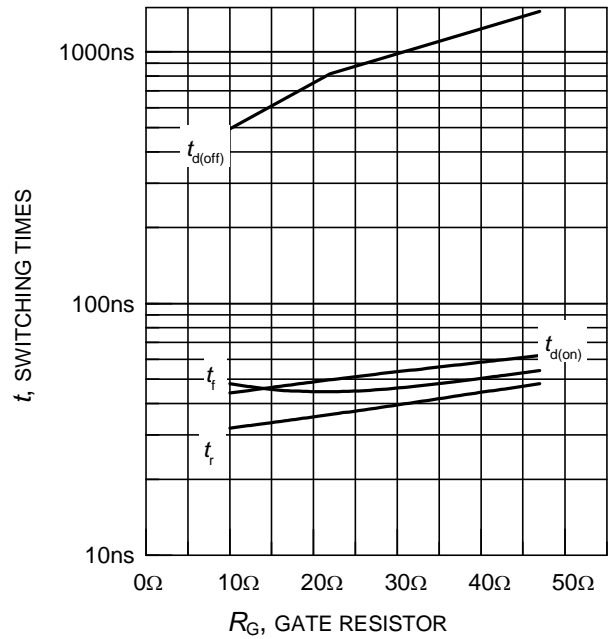

Figure 10. Typical switching times as a function of gate resistor
 (inductive load, $T_j = 150^\circ\text{C}$,
 $V_{CE} = 800\text{V}$, $V_{GE} = +15\text{V}/0\text{V}$, $I_C = 25\text{A}$,
 dynamic test circuit in Fig.E)

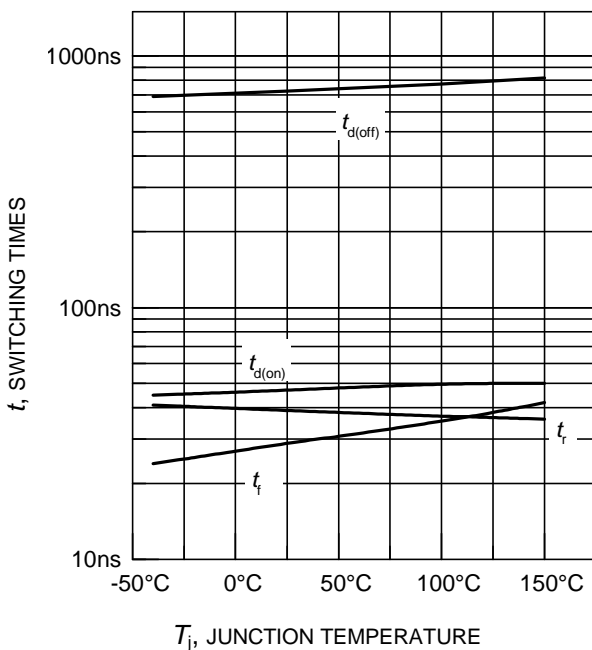

Figure 11. Typical switching times as a function of junction temperature
 (inductive load, $V_{CE} = 800\text{V}$,
 $V_{GE} = +15\text{V}/0\text{V}$, $I_C = 25\text{A}$, $R_G = 22\Omega$,
 dynamic test circuit in Fig.E)

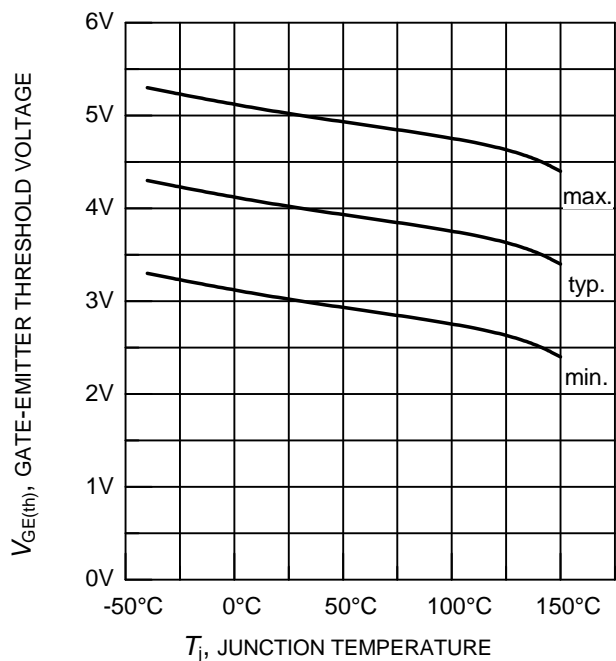

Figure 12. Gate-emitter threshold voltage as a function of junction temperature
 ($I_C = 0.3\text{mA}$)

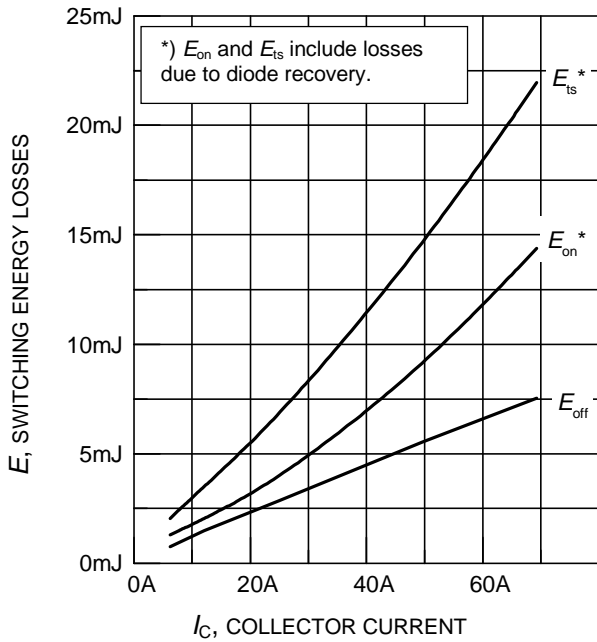

Figure 13. Typical switching energy losses as a function of collector current (inductive load, $T_j = 150^\circ\text{C}$, $V_{CE} = 800\text{V}$, $V_{GE} = +15\text{V}/0\text{V}$, $R_G = 22\Omega$, dynamic test circuit in Fig.E)

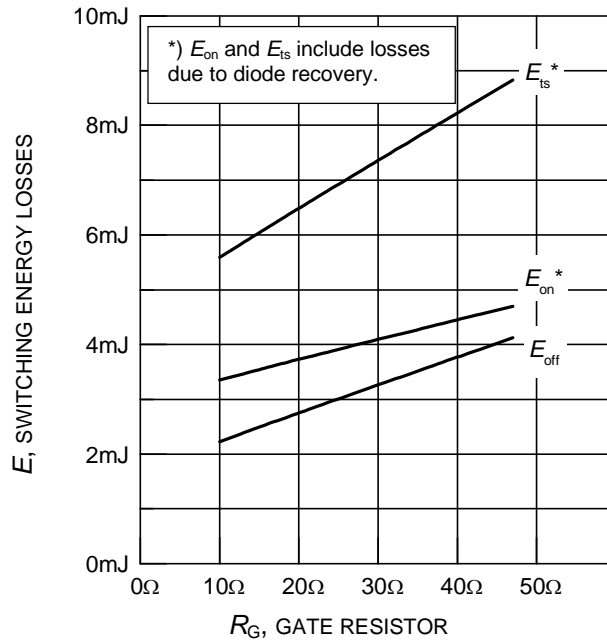

Figure 14. Typical switching energy losses as a function of gate resistor (inductive load, $T_j = 150^\circ\text{C}$, $V_{CE} = 800\text{V}$, $V_{GE} = +15\text{V}/0\text{V}$, $I_C = 25\text{A}$, dynamic test circuit in Fig.E)

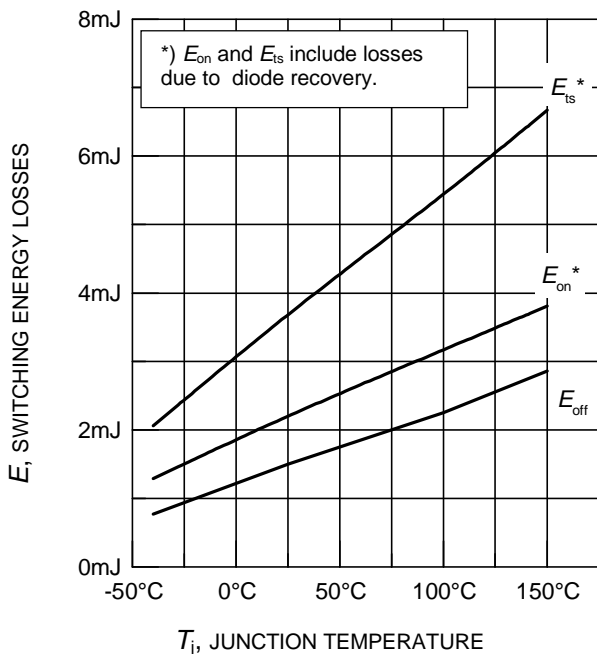

Figure 15. Typical switching energy losses as a function of junction temperature (inductive load, $V_{CE} = 800\text{V}$, $V_{GE} = +15\text{V}/0\text{V}$, $I_C = 25\text{A}$, $R_G = 22\Omega$, dynamic test circuit in Fig.E)

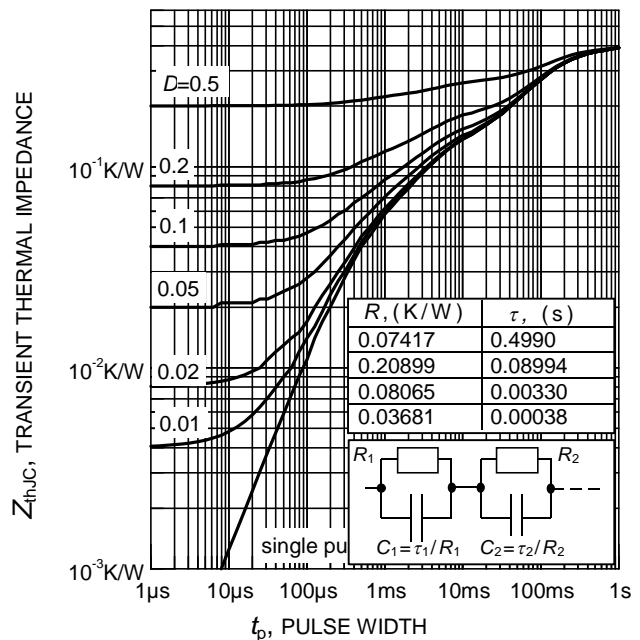

Figure 16. IGBT transient thermal impedance as a function of pulse width ($D = t_p / T$)

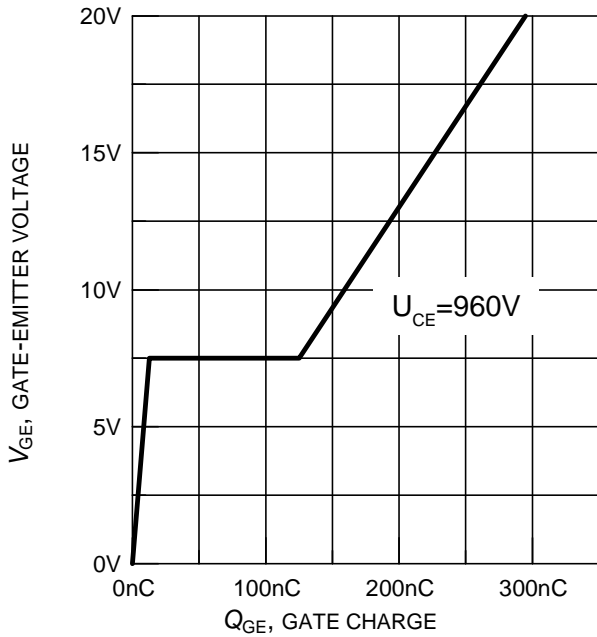

Figure 17. Typical gate charge
($I_C = 25A$)

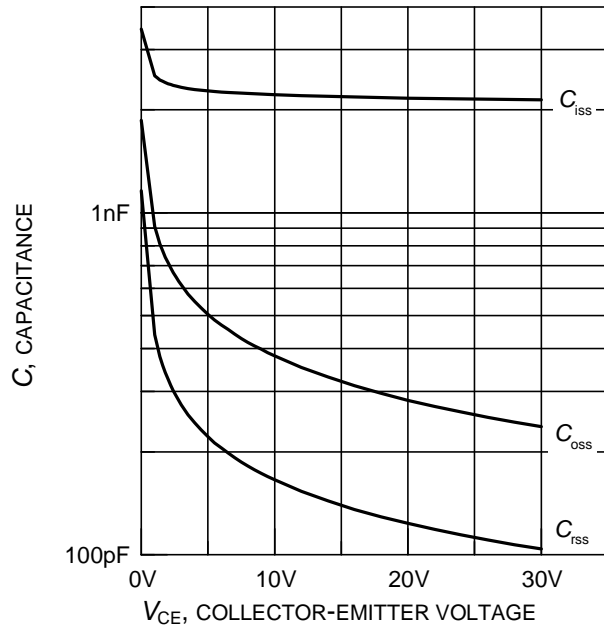

Figure 18. Typical capacitance as a function of collector-emitter voltage
($V_{GE} = 0V, f = 1MHz$)

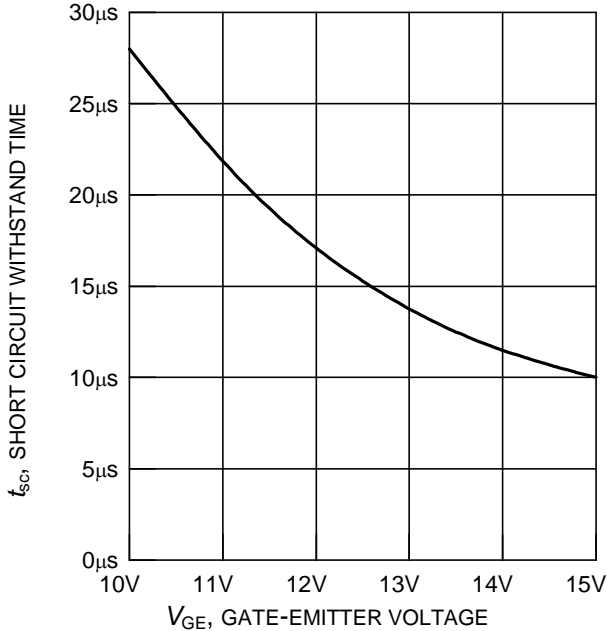

Figure 19. Short circuit withstand time as a function of gate-emitter voltage
($V_{CE} = 1200V, \text{start at } T_j = 25^\circ C$)

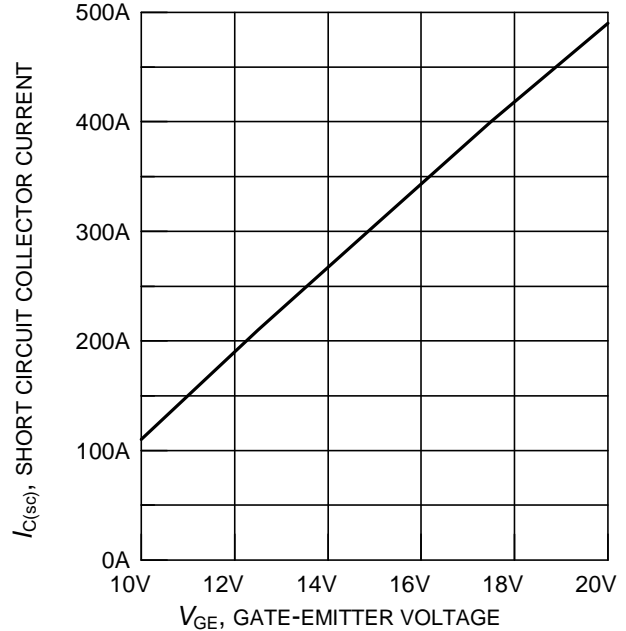

Figure 20. Typical short circuit collector current as a function of gate-emitter voltage
($100V \leq V_{CE} \leq 1200V, T_C = 25^\circ C, T_j \leq 150^\circ C$)

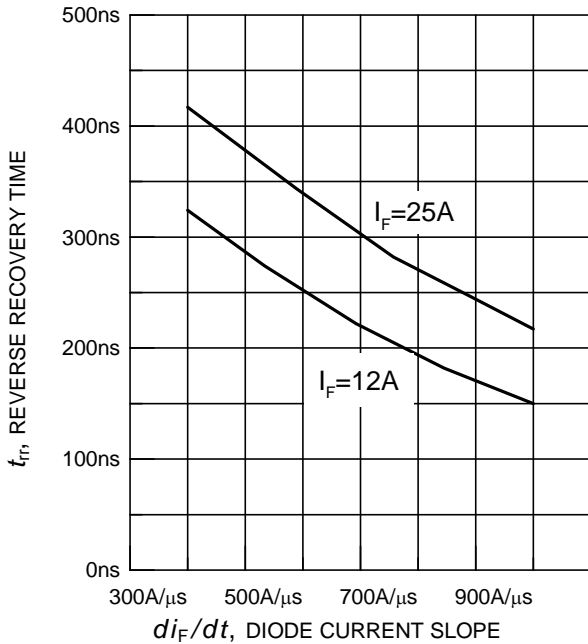

Figure 21. Typical reverse recovery time as a function of diode current slope
 ($V_R = 800V$, $T_j = 150^\circ C$, dynamic test circuit in Fig.E)

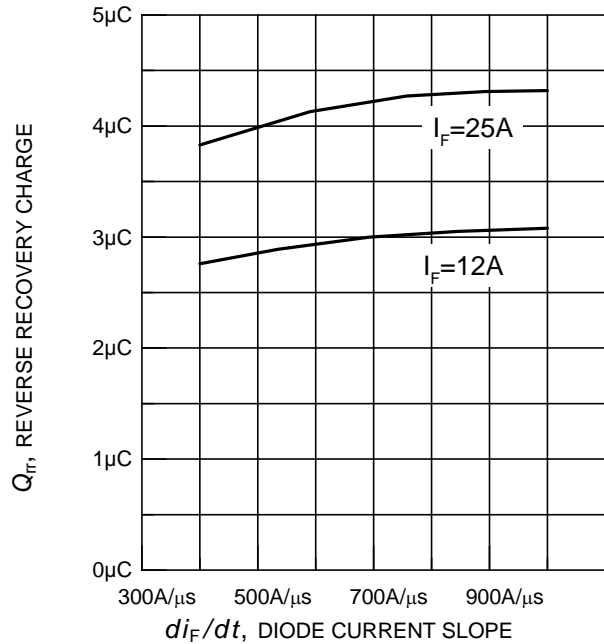

Figure 22. Typical reverse recovery charge as a function of diode current slope
 ($V_R = 800V$, $T_j = 150^\circ C$, dynamic test circuit in Fig.E)

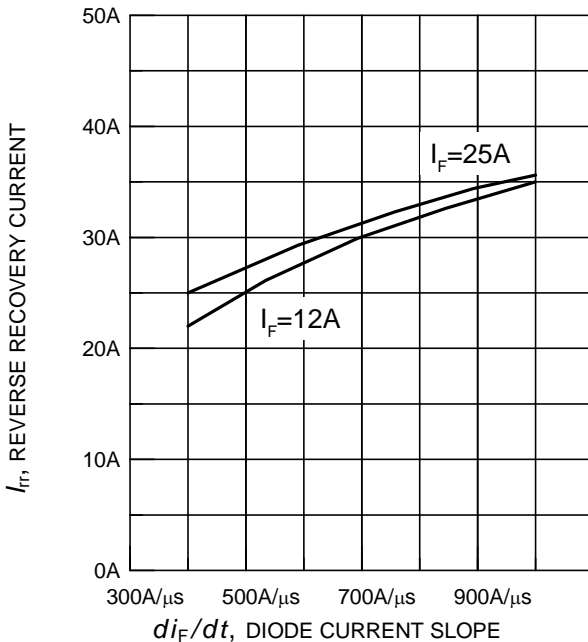

Figure 23. Typical reverse recovery current as a function of diode current slope
 ($V_R = 800V$, $T_j = 150^\circ C$, dynamic test circuit in Fig.E)

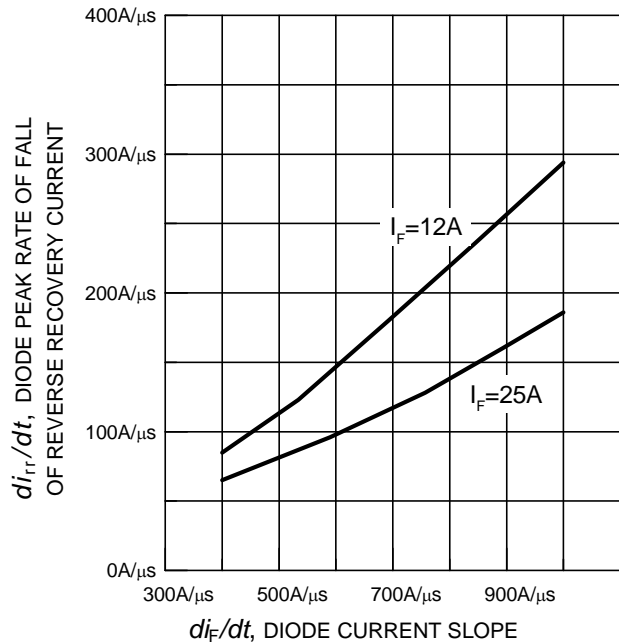

Figure 24. Typical diode peak rate of fall of reverse recovery current as a function of diode current slope
 ($V_R = 800V$, $T_j = 150^\circ C$, dynamic test circuit in Fig.E)

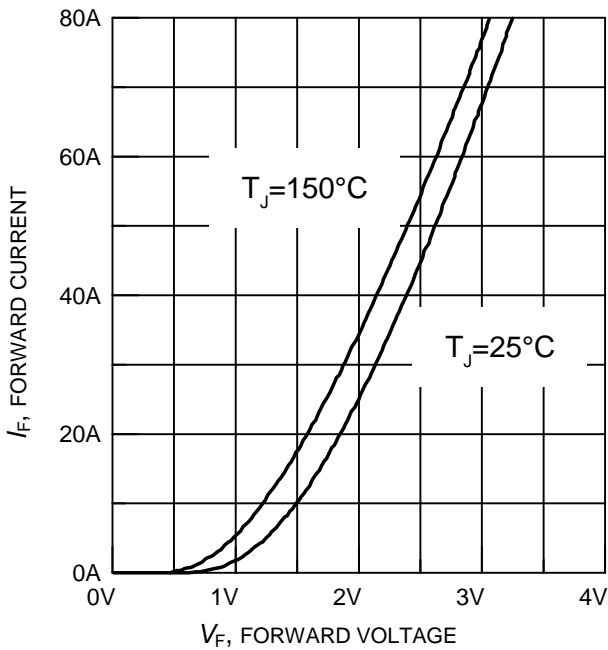

Figure 25. Typical diode forward current as a function of forward voltage

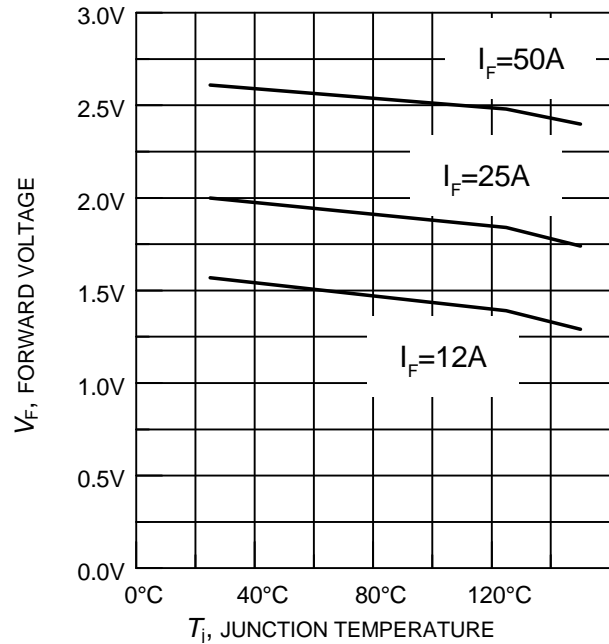

Figure 26. Typical diode forward voltage as a function of junction temperature

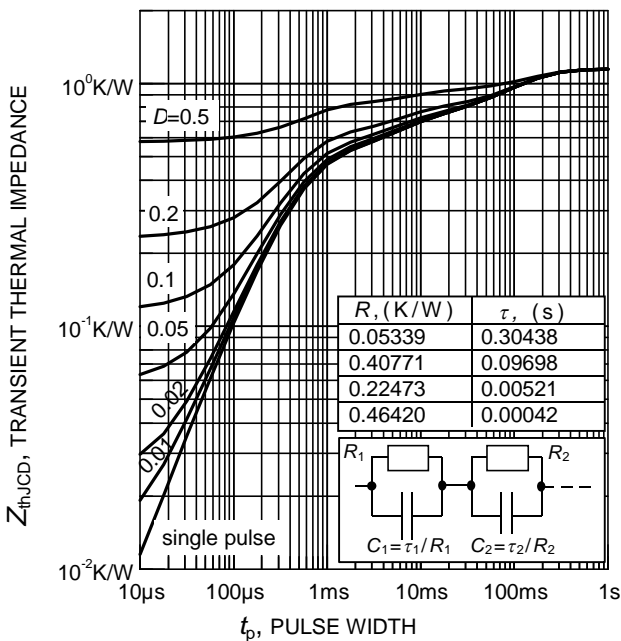
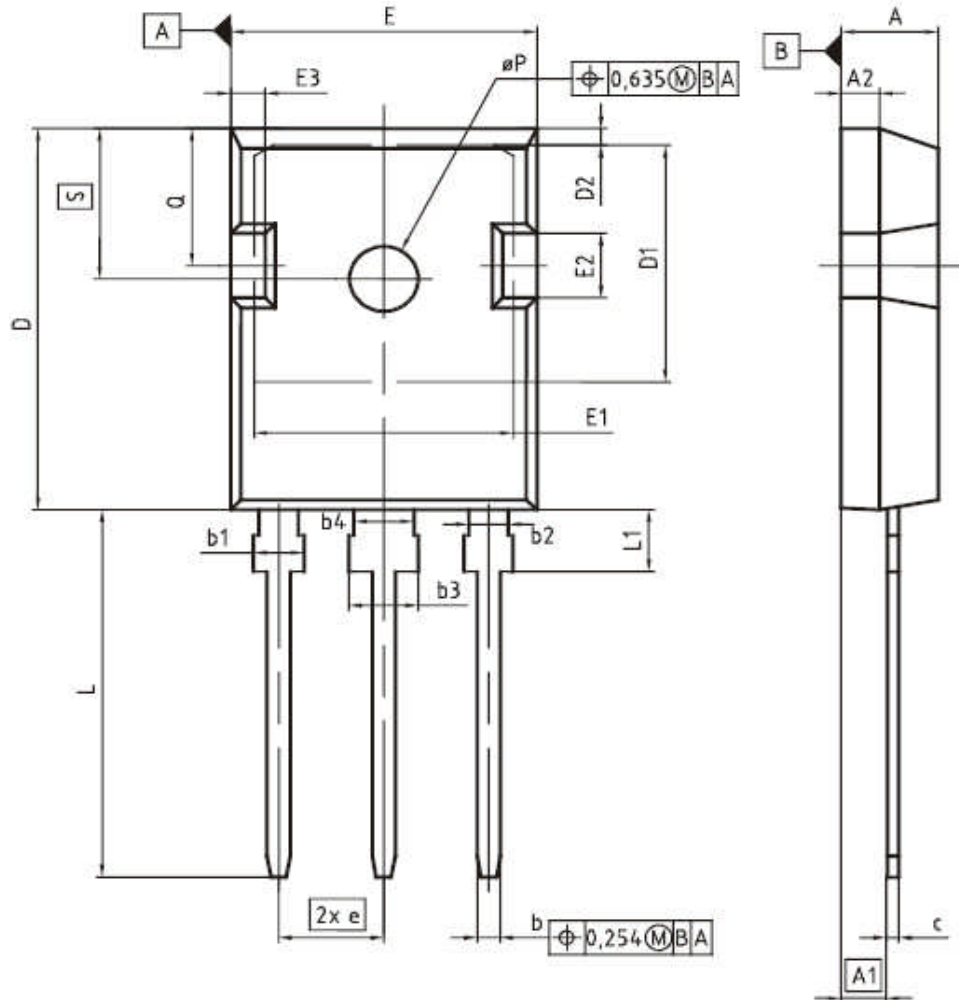

Figure 27. Diode transient thermal impedance as a function of pulse width ($D = t_p / T$)

PG-TO247-3



DIM	MILLIMETERS		INCHES	
	MIN	MAX	MIN	MAX
A	4,83	5,21	0,190	0,205
A1	2,27	2,54	0,089	0,100
A2	1,85	2,16	0,073	0,085
b	1,07	1,33	0,042	0,052
b1	1,90	2,41	0,075	0,095
b2	1,90	2,16	0,075	0,085
b3	2,87	3,38	0,113	0,133
b4	2,87	3,13	0,113	0,123
c	0,55	0,68	0,022	0,027
D	20,80	21,10	0,819	0,831
D1	16,25	17,65	0,640	0,695
D2	0,95	1,35	0,037	0,053
E	15,70	16,13	0,618	0,635
E1	13,10	14,15	0,516	0,557
E2	3,68	5,10	0,145	0,201
E3	1,00	2,60	0,039	0,102
e	5,44 (BSC)		0,214 (BSC)	
N	3		3	
L	19,80	20,32	0,780	0,800
L1	4,10	4,47	0,161	0,176
ϕP	3,50	3,70	0,138	0,146
Q	5,49	6,00	0,216	0,236
S	6,04	6,30	0,238	0,248

DOCUMENT NO.
Z8B00003327

SCALE

EUROPEAN PROJECTION

ISSUE DATE
09-07-2010

REVISION
05

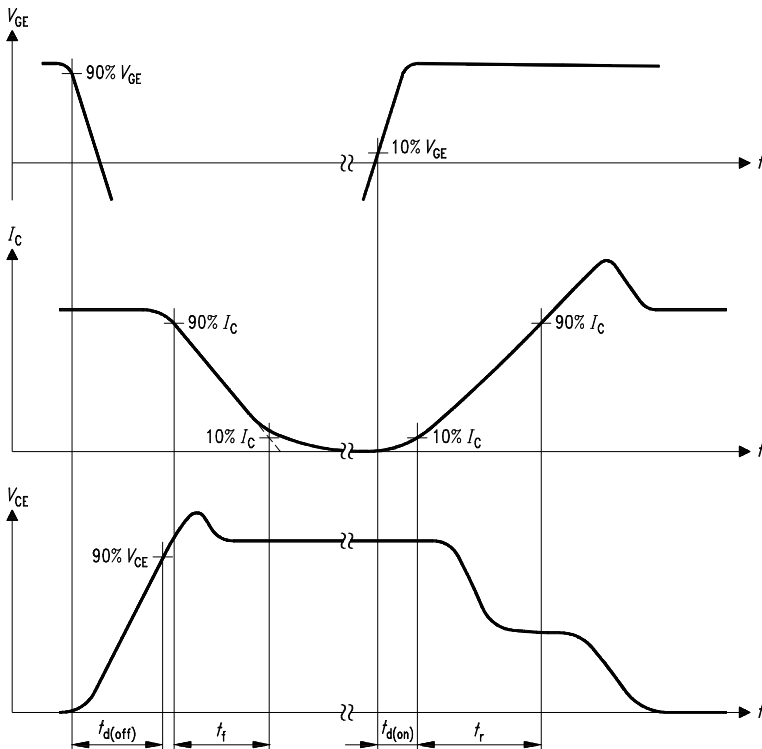

Figure A. Definition of switching times

SIS00053

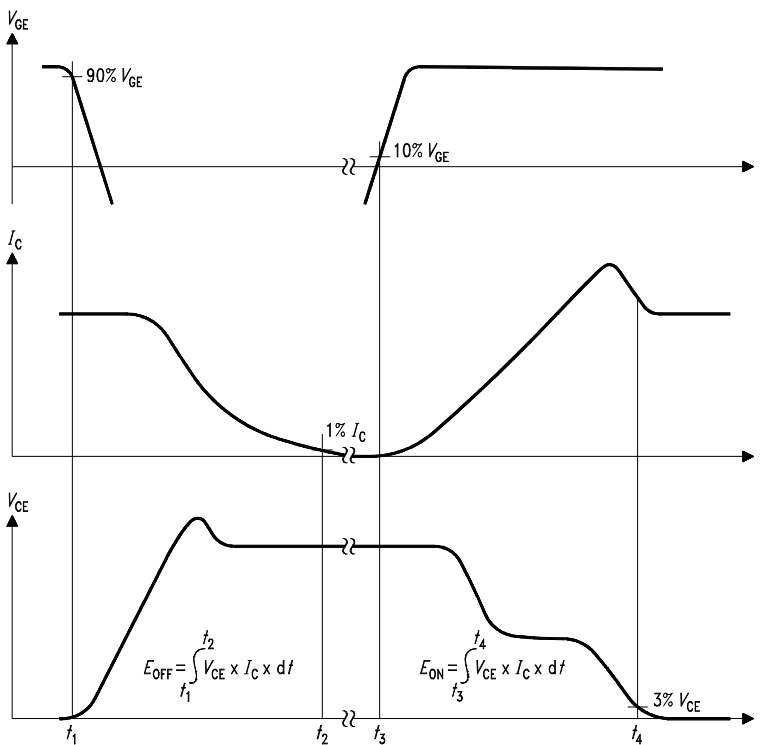

Figure B. Definition of switching losses

SIS00050

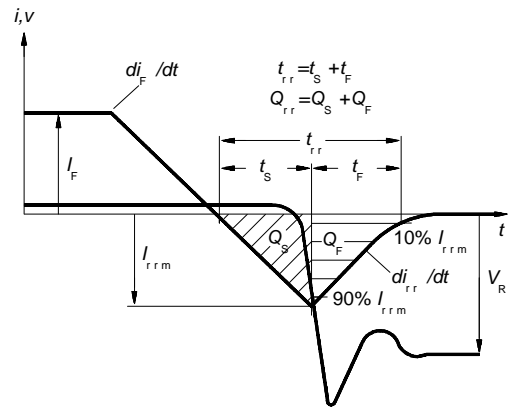

Figure C. Definition of diodes switching characteristics

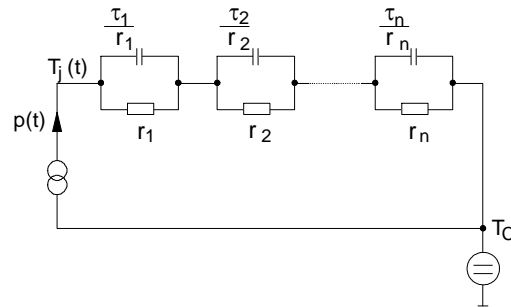

Figure D. Thermal equivalent circuit

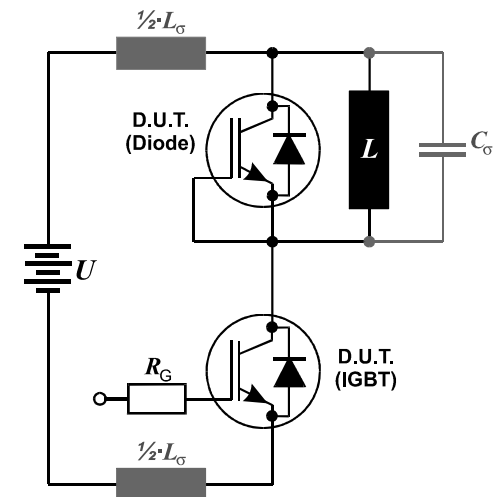

Figure E. Dynamic test circuit
Leakage inductance $L_{\sigma}=180\text{nH}$,
and stray capacity $C_{\sigma}=40\text{pF}$.

Published by
Infineon Technologies AG
81726 Munich, Germany
© 2013 Infineon Technologies AG
All Rights Reserved.

Legal Disclaimer

The information given in this document shall in no event be regarded as a guarantee of conditions or characteristics. With respect to any examples or hints given herein, any typical values stated herein and/or any information regarding the application of the device, Infineon Technologies hereby disclaims any and all warranties and liabilities of any kind, including without limitation, warranties of non-infringement of intellectual property rights of any third party.

Information

For further information on technology, delivery terms and conditions and prices, please contact the nearest Infineon Technologies Office (www.infineon.com).

Warnings

Due to technical requirements, components may contain dangerous substances. For information on the types in question, please contact the nearest Infineon Technologies Office.
The Infineon Technologies component described in this Data Sheet may be used in life-support devices or systems and/or automotive, aviation and aerospace applications or systems only with the express written approval of Infineon Technologies, if a failure of such components can reasonably be expected to cause the failure of that life-support, automotive, aviation and aerospace device or system or to affect the safety or effectiveness of that device or system. Life support devices or systems are intended to be implanted in the human body or to support and/or maintain and sustain and/or protect human life. If they fail, it is reasonable to assume that the health of the user or other persons may be endangered.

X-ON Electronics

Largest Supplier of Electrical and Electronic Components

Click to view similar products for [IGBT Transistors](#) category:

Click to view products by [Infineon](#) manufacturer:

Other Similar products are found below :

[748152A](#) [APT20GT60BRDQ1G](#) [APT50GT60BRG](#) [NGTB10N60FG](#) [STGFW20V60DF](#) [APT30GP60BG](#) [APT45GR65B2DU30](#)
[GT50JR22\(STA1ES\)](#) [TIG058E8-TL-H](#) [IGW40N120H3FKSA1](#) [VS-CPV364M4KPBF](#) [NGTB25N120FL2WAG](#) [NGTG40N120FL2WG](#)
[RJH60F3DPQ-A0#T0](#) [APT40GR120B2SCD10](#) [APT15GT120BRG](#) [APT20GT60BRG](#) [NGTB75N65FL2WAG](#) [NGTG15N120FL2WG](#)
[IXA30RG1200DHGLB](#) [IXA40RG1200DHGLB](#) [APT70GR65B2DU40](#) [NTE3320](#) [QP12W05S-37A](#) [IHF40N65R5SXXSA1](#) [APT70GR120J](#)
[APT35GP120JDQ2](#) [XD15H120CX1](#) [XD25H120CX0](#) [XP15PJS120CL1B1](#) [IGW30N60H3FKSA1](#) [STGWA8M120DF3](#) [IGW08T120FKSA1](#)
[IGW75N60H3FKSA1](#) [FGH60N60SMD_F085](#) [FGH75T65UPD](#) [STGWA15H120F2](#) [IKA10N60TXKSA1](#) [IHW20N120R5XKSA1](#)
[RJH60D2DPP-M0#T2](#) [IKP20N60TXKSA1](#) [IHW20N65R5XKSA1](#) [APT70GR120JD60](#) [AOD5B60D](#) [APT70GR120L](#) [STGWT60H65FB](#)
[STGWT60H65DFB](#) [STGWT40V60DF](#) [STGWT20V60DF](#) [STGB10NB37LZT4](#)