

**Cool MOS™ Power Transistor**
**Feature**

- New revolutionary high voltage technology
- Worldwide best  $R_{DS(on)}$  in TO-252
- Ultra low gate charge
- Periodic avalanche rated
- Extreme  $dv/dt$  rated
- Ultra low effective capacitances
- Improved transconductance
- Pb-free lead plating; RoHS compliant, available in Halogen free mold compound<sup>a)</sup>
- Fully qualified according to JEDEC for Industrial Applications

|                     |     |          |
|---------------------|-----|----------|
| $V_{DS} @ T_{jmax}$ | 560 | V        |
| $R_{DS(on)}$        | 0.6 | $\Omega$ |
| $I_D$               | 7.6 | A        |



PG-TO252

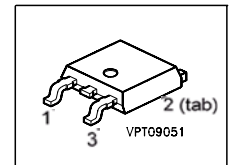

| Type       | Package  | Ordering Code | Marking |
|------------|----------|---------------|---------|
| SPD08N50C3 | PG-TO252 | Q67040-S4569  | 08N50C3 |

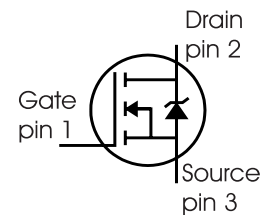
**Maximum Ratings, at  $T_C = 25^\circ\text{C}$ , unless otherwise specified**

| Parameter   | Symbol         | Value       | Unit             |
|---|----------------|-------------|------------------|
| Continuous drain current<br>$T_C = 25^\circ\text{C}$<br>$T_C = 100^\circ\text{C}$                                 | $I_D$          | 7.6<br>4.6  | A                |
| Pulsed drain current, $t_p$ limited by $T_{jmax}$   | $I_{D\ puls}$  | 22.8        |                  |
| Avalanche energy, single pulse<br>$I_D=5.5\text{A}, V_{DD}=50\text{V}$  | $E_{AS}$       | 230         | mJ               |
| Avalanche energy, repetitive $t_{AR}$ limited by $T_{jmax}$ <sup>1)</sup><br>$I_D=7.6\text{A}, V_{DD}=50\text{V}$ | $E_{AR}$       | 0.5         |                  |
| Avalanche current, repetitive $t_{AR}$ limited by $T_{jmax}$  | $I_{AR}$       | 7.6         | A                |
| Gate source voltage   | $V_{GS}$       | $\pm 20$    | V                |
| Gate source voltage AC ( $f > 1\text{Hz}$ )   | $V_{GS}$       | $\pm 30$    |                  |
| Power dissipation, $T_C = 25^\circ\text{C}$   | $P_{tot}$      | 83          | W                |
| Operating and storage temperature   | $T_j, T_{stg}$ | -55... +150 | $^\circ\text{C}$ |
| Reverse diode $dv/dt$ <sup>6)</sup>   | $dv/dt$        | 15          | V/ns             |

<sup>a)</sup> non-Halogen free (OPN: SPD08N50C3BT), Halogen free (OPN: SPD08N50C3AT)

**Maximum Ratings**

| Parameter   | Symbol  | Value | Unit |
|---|---------|-------|------|
| Drain Source voltage slope<br>$V_{DS} = 400 \text{ V}$ , $I_D = 7.6 \text{ A}$ , $T_j = 125 \text{ }^\circ\text{C}$ | $dv/dt$ | 50    | V/ns |

**Thermal Characteristics**

| Parameter   | Symbol     | Values |      |          | Unit             |
|---|------------|--------|------|----------|------------------|
|   |            | min.   | typ. | max.     |                  |
| Thermal resistance, junction - case   | $R_{thJC}$ | -      | -    | 1.5      | K/W              |
| Thermal resistance, junction - ambient, leaded  | $R_{thJA}$ | -      | -    | 75       |                  |
| SMD version, device on PCB:<br>@ min. footprint<br>@ 6 cm <sup>2</sup> cooling area <sup>2)</sup>   | $R_{thJA}$ | -      | -    | 75<br>50 |                  |
| Soldering temperature, reflow soldering, MSL3<br>1.6 mm (0.063 in.) from case for 10s <sup>3)</sup> | $T_{sold}$ | -      | -    | 260      | $^\circ\text{C}$ |

**Electrical Characteristics**

| Parameter                                   | Symbol        | Conditions   | Values |            |          | Unit          |
|---|---------------|--|--------|------------|----------|---------------|
|   |               |  | min.   | typ.       | max.     |               |
| Drain-source breakdown voltage              | $V_{(BR)DSS}$ | $V_{GS}=0\text{V}$ , $I_D=0.25\text{mA}$   | 500    | -          | -        | V             |
| Drain-Source avalanche<br>breakdown voltage | $V_{(BR)DS}$  | $V_{GS}=0\text{V}$ , $I_D=7.6\text{A}$   | -      | 600        | -        |               |
| Gate threshold voltage                      | $V_{GS(th)}$  | $I_D=350\mu\text{A}$ , $V_{GS}=V_{DS}$   | 2.1    | 3          | 3.9      |               |
| Zero gate voltage drain current             | $I_{DSS}$     | $V_{DS}=500\text{V}$ , $V_{GS}=0\text{V}$ ,<br>$T_j=25^\circ\text{C}$ ,<br>$T_j=150^\circ\text{C}$ | -      | 0.5        | 1<br>100 | $\mu\text{A}$ |
| Gate-source leakage current                 | $I_{GSS}$     | $V_{GS}=20\text{V}$ , $V_{DS}=0\text{V}$   | -      | -          | 100      | nA            |
| Drain-source on-state resistance            | $R_{DS(on)}$  | $V_{GS}=10\text{V}$ , $I_D=4.6\text{A}$ ,<br>$T_j=25^\circ\text{C}$<br>$T_j=150^\circ\text{C}$     | -      | 0.5<br>1.5 | 0.6<br>- | $\Omega$      |
| Gate input resistance                       | $R_G$         | $f=1\text{MHz}$ , open Drain   | -      | 1.2        | -        |               |

**Electrical Characteristics** , at  $T_j = 25\text{ °C}$ , unless otherwise specified

| Parameter   | Symbol       | Conditions   | Values |      |      | Unit |
|---|--------------|--|--------|------|------|------|
|   |              |  | min.   | typ. | max. |      |
| Transconductance  | $g_{fs}$     | $V_{DS} \geq 2 \cdot I_D \cdot R_{DS(on)max}$<br>$I_D = 4.6A$    | -      | 6    | -    | S    |
| Input capacitance   | $C_{iss}$    | $V_{GS} = 0V, V_{DS} = 25V,$<br>$f = 1MHz$                       | -      | 750  | -    | pF   |
| Output capacitance  | $C_{oss}$    |  | -      | 350  | -    |      |
| Reverse transfer capacitance                                  | $C_{rss}$    |  | -      | 12   | -    |      |
| Effective output capacitance, <sup>4)</sup><br>energy related | $C_{o(er)}$  | $V_{GS} = 0V,$<br>$V_{DS} = 0V \text{ to } 400V$                 | -      | 56   | -    | pF   |
| Effective output capacitance, <sup>5)</sup><br>time related   | $C_{o(tr)}$  |  | -      | 30   | -    |      |
| Turn-on delay time  | $t_{d(on)}$  | $V_{DD} = 400V, V_{GS} = 0/10V,$<br>$I_D = 7.6A, R_G = 12\Omega$ | -      | 6    | -    | ns   |
| Rise time   | $t_r$        |  | -      | 5    | -    |      |
| Turn-off delay time   | $t_{d(off)}$ |  | -      | 60   | -    |      |
| Fall time   | $t_f$        |  | -      | 7    | -    |      |

**Gate Charge Characteristics**

|                       |                 |  |   |    |   |    |
|-----------------------|-----------------|--|---|----|---|----|
| Gate to source charge | $Q_{gs}$        | $V_{DD} = 400V, I_D = 7.6A$                                  | - | 3  | - | nC |
| Gate to drain charge  | $Q_{gd}$        |  | - | 17 | - |    |
| Gate charge total     | $Q_g$           | $V_{DD} = 400V, I_D = 7.6A,$<br>$V_{GS} = 0 \text{ to } 10V$ | - | 32 | - |    |
| Gate plateau voltage  | $V_{(plateau)}$ | $V_{DD} = 400V, I_D = 7.6A$                                  | - | 5  | - | V  |

<sup>1</sup> Repetitive avalanche causes additional power losses that can be calculated as  $P_{AV} = E_{AR} \cdot f$ .

<sup>2</sup> Device on 40mm\*40mm\*1.5mm epoxy PCB FR4 with 6cm<sup>2</sup> (one layer, 70 μm thick) copper area for drain connection. PCB is vertical without blown air.

<sup>3</sup> Soldering temperature for TO-263: 220°C, reflow

<sup>4</sup>  $C_{o(er)}$  is a fixed capacitance that gives the same stored energy as  $C_{oss}$  while  $V_{DS}$  is rising from 0 to 80%  $V_{DSS}$ .

<sup>5</sup>  $C_{o(tr)}$  is a fixed capacitance that gives the same charging time as  $C_{oss}$  while  $V_{DS}$  is rising from 0 to 80%  $V_{DSS}$ .

<sup>6</sup>  $I_{SD} \leq I_D, di/dt \leq 400A/\mu s, V_{DClink} = 400V, V_{peak} < V_{BR, DSS}, T_j < T_{j,max}$ .

Identical low-side and high-side switch.

**Electrical Characteristics**, at  $T_j = 25\text{ °C}$ , unless otherwise specified

| Parameter                                     | Symbol       | Conditions           | Values |      |      | Unit      |
|---|--------------|----------------------|--------|------|------|-----------|
|   |              |                      | min.   | typ. | max. |           |
| Inverse diode continuous forward current      | $I_S$        | $T_C=25\text{ °C}$   | -      | -    | 7.6  | A         |
| Inverse diode direct current, pulsed          | $I_{SM}$     |                      | -      | -    | 22.8 |           |
| Inverse diode forward voltage                 | $V_{SD}$     | $V_{GS}=0V, I_F=I_S$ | -      | 1    | 1.2  | V         |
| Reverse recovery time                         | $t_{rr}$     | $V_R=400V, I_F=I_S,$ | -      | 370  | -    | ns        |
| Reverse recovery charge                       | $Q_{rr}$     | $di_F/dt=100A/\mu s$ | -      | 3.6  | -    | $\mu C$   |
| Peak reverse recovery current                 | $I_{rrm}$    |                      | -      | 25   | -    | A         |
| Peak rate of fall of reverse recovery current | $di_{rr}/dt$ |                      | -      | 700  | -    | $A/\mu s$ |

**Typical Transient Thermal Characteristics**

| Symbol             | Value | Unit | Symbol              | Value     | Unit |
|--------------------|-------|------|---------------------|-----------|------|
|                    | typ.  |      |                     | typ.      |      |
| Thermal resistance |       |      | Thermal capacitance |           |      |
| $R_{th1}$          | 0.024 | K/W  | $C_{th1}$           | 0.00012   | Ws/K |
| $R_{th2}$          | 0.046 |      | $C_{th2}$           | 0.0004578 |      |
| $R_{th3}$          | 0.085 |      | $C_{th3}$           | 0.000645  |      |
| $R_{th4}$          | 0.308 |      | $C_{th4}$           | 0.001867  |      |
| $R_{th5}$          | 0.317 |      | $C_{th5}$           | 0.004795  |      |
| $R_{th6}$          | 0.112 |      | $C_{th6}$           | 0.045     |      |

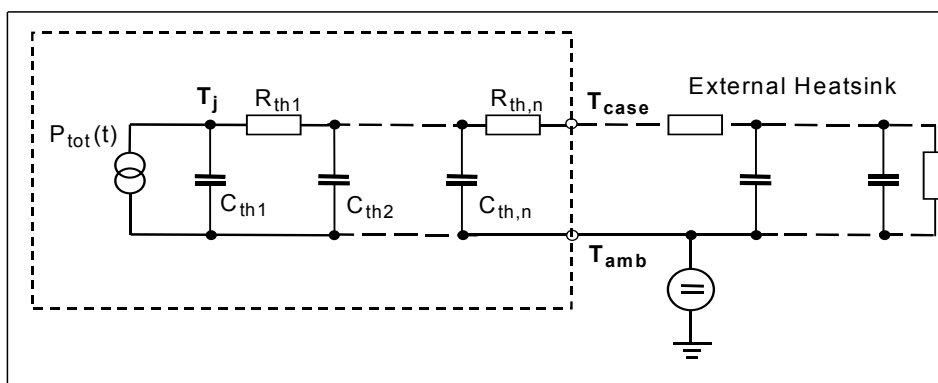

**1 Power dissipation**

$P_{tot} = f(T_C)$

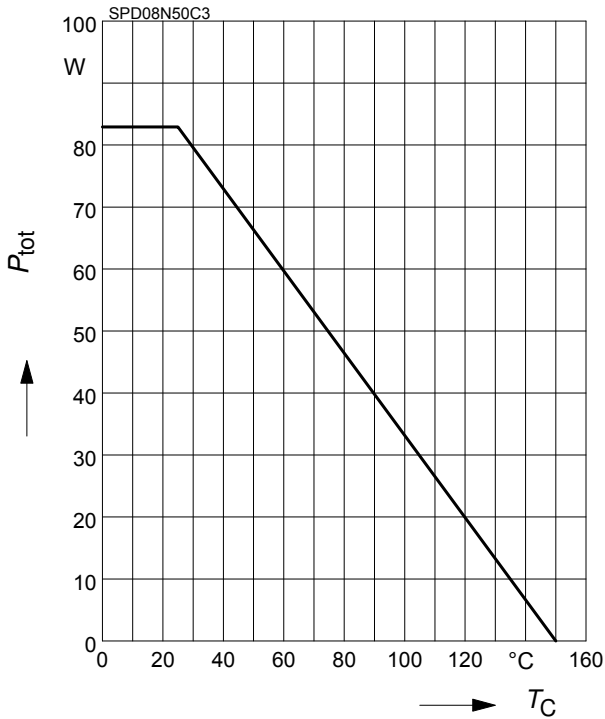

**2 Safe operating area**

$I_D = f(V_{DS})$

parameter :  $D = 0$  ,  $T_C = 25^\circ C$

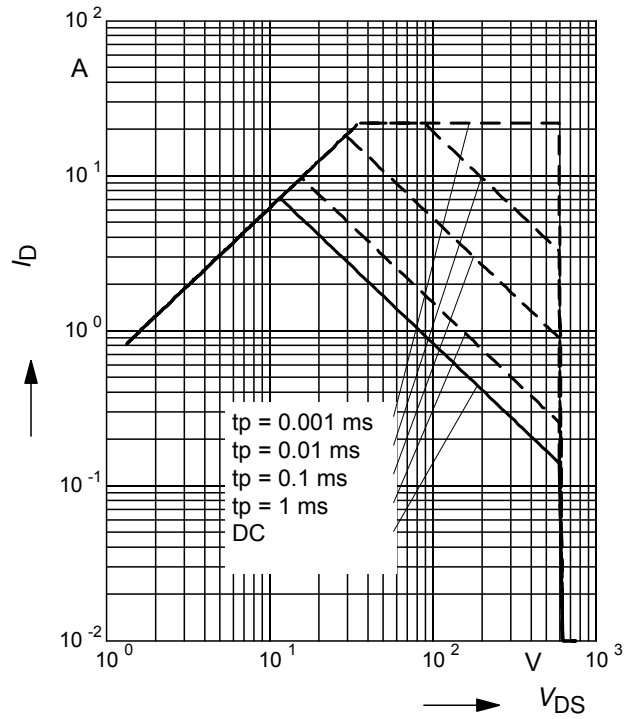

**3 Transient thermal impedance**

$Z_{thJC} = f(t_p)$

parameter:  $D = t_p/T$

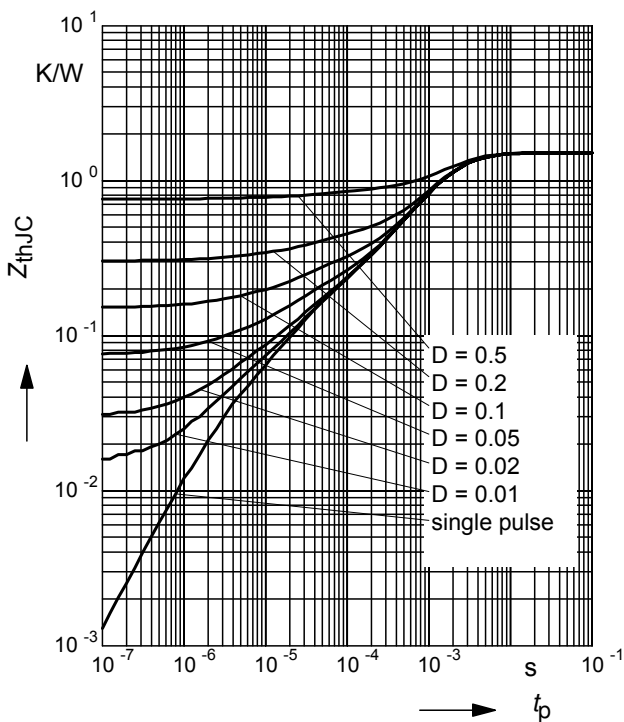

**4 Typ. output characteristic**

$I_D = f(V_{DS})$ ;  $T_j = 25^\circ C$

parameter:  $t_p = 10 \mu s$ ,  $V_{GS}$

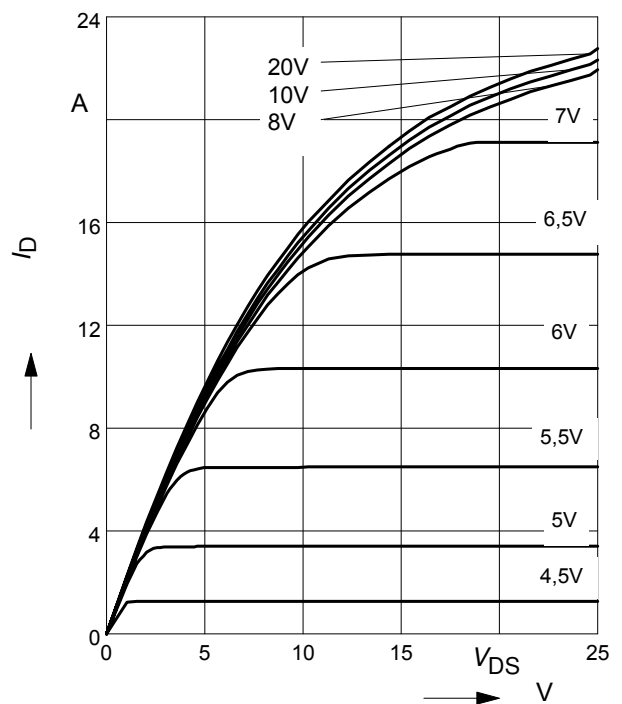

**5 Typ. output characteristic**

$I_D = f(V_{DS}); T_j = 150^\circ\text{C}$   
 parameter:  $t_p = 10 \mu\text{s}, V_{GS}$

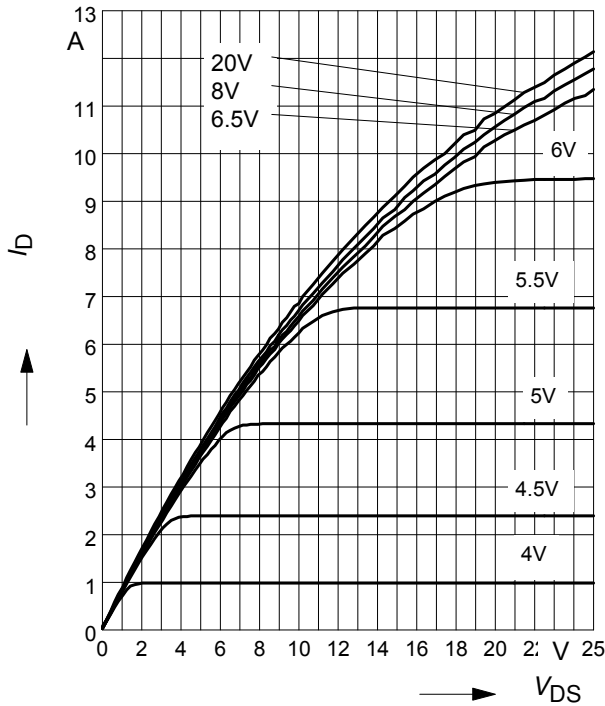

**6 Typ. drain-source on resistance**

$R_{DS(on)} = f(I_D)$   
 parameter:  $T_j = 150^\circ\text{C}, V_{GS}$

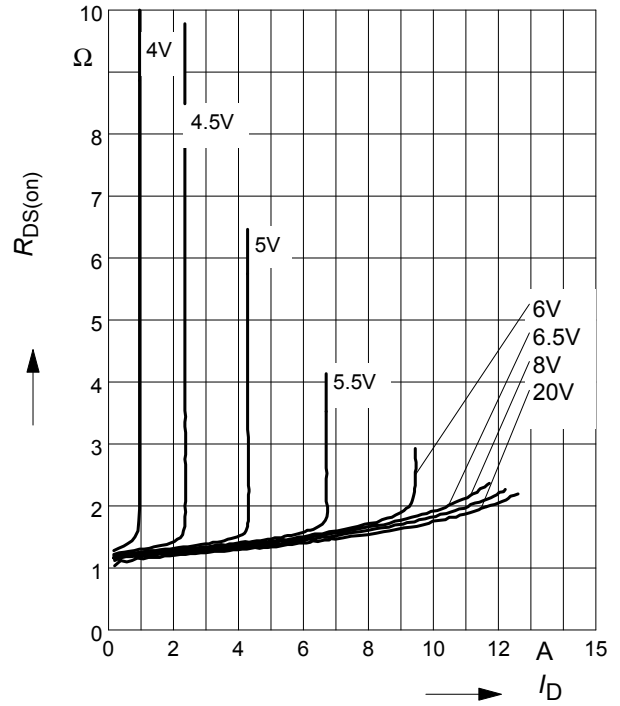

**7 Drain-source on-state resistance**

$R_{DS(on)} = f(T_j)$   
 parameter:  $I_D = 4.6 \text{ A}, V_{GS} = 10 \text{ V}$

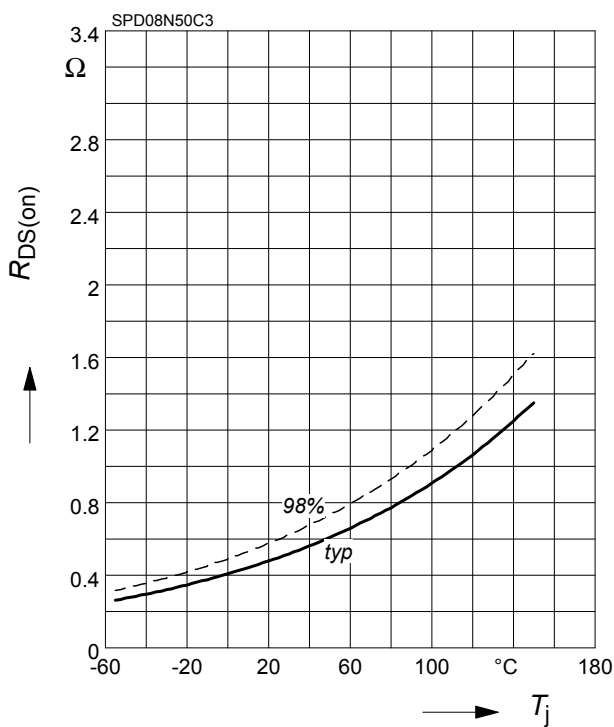

**8 Typ. transfer characteristics**

$I_D = f(V_{GS}); V_{DS} \geq 2 \times I_D \times R_{DS(on)max}$   
 parameter:  $t_p = 10 \mu\text{s}$

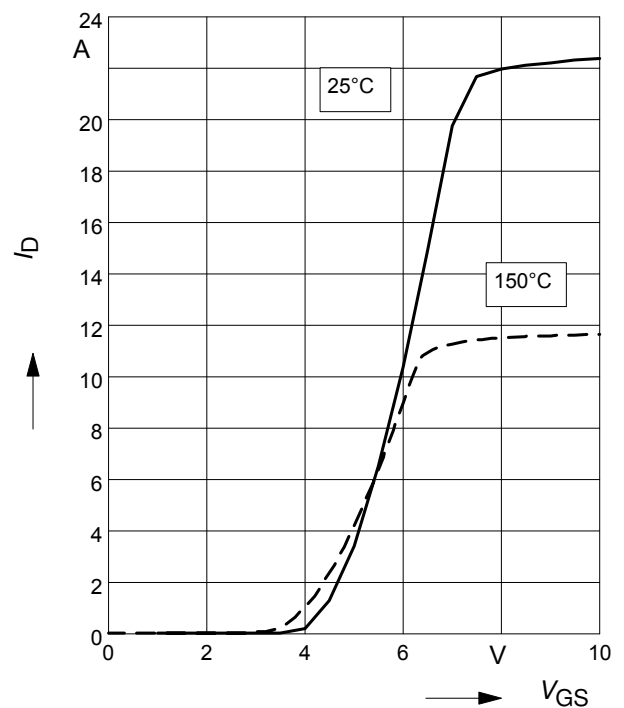

**9 Typ. gate charge**

$$V_{GS} = f(Q_{Gate})$$

parameter:  $I_D = 7.6 \text{ A pulsed}$

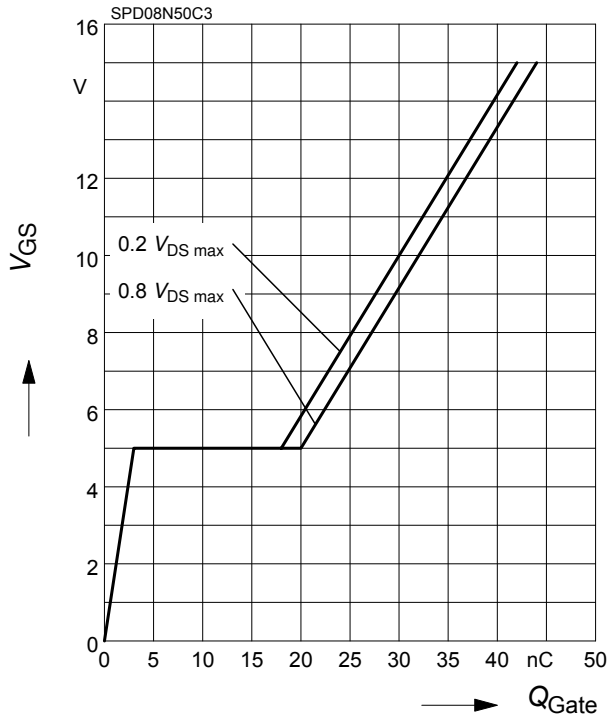

**10 Forward characteristics of body diode**

$$I_F = f(V_{SD})$$

parameter:  $T_j, t_p = 10 \mu\text{s}$

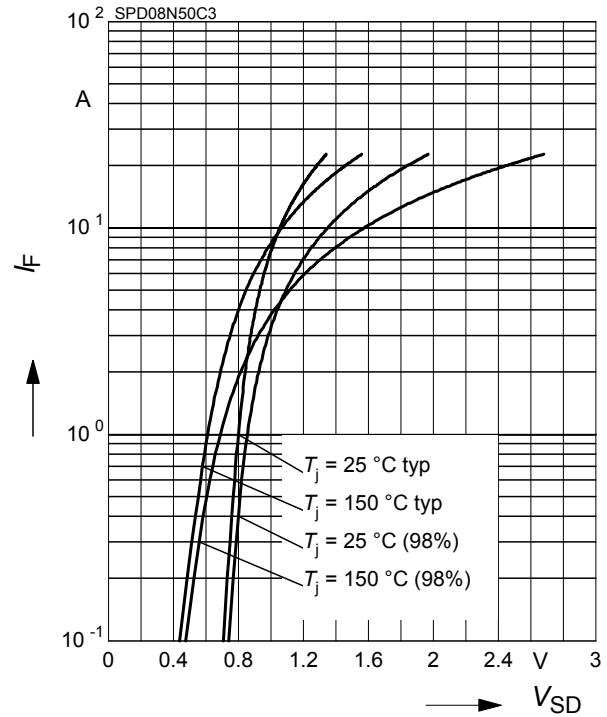

**11 Avalanche SOA**

$$I_{AR} = f(t_{AR})$$

par.:  $T_j \leq 150 \text{ °C}$

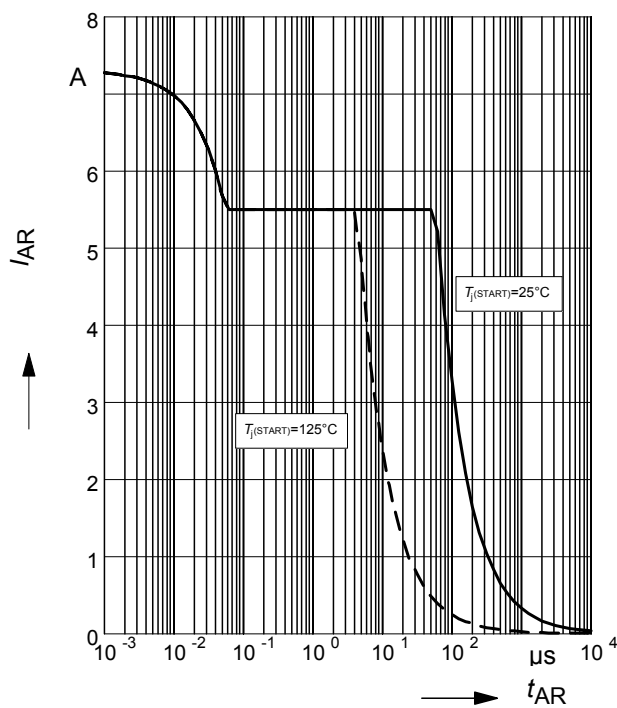

**12 Avalanche energy**

$$E_{AS} = f(T_j)$$

par.:  $I_D = 5.5 \text{ A}, V_{DD} = 50 \text{ V}$

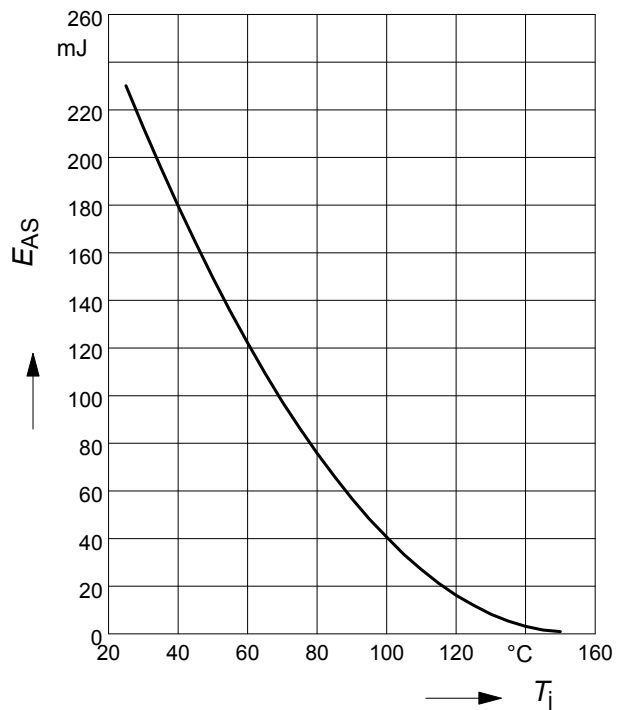

**13 Drain-source breakdown voltage**

$$V_{(BR)DSS} = f(T_j)$$

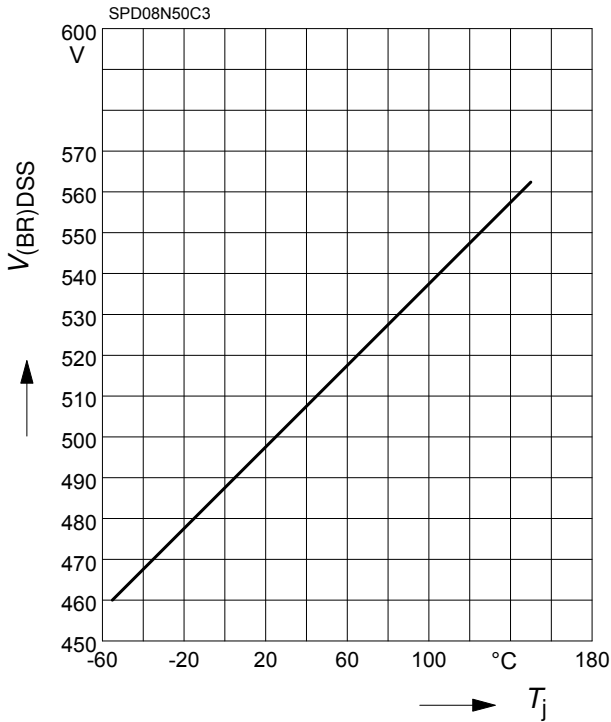

**14 Avalanche power losses**

$$P_{AR} = f(f)$$

parameter:  $E_{AR}=0.5mJ$

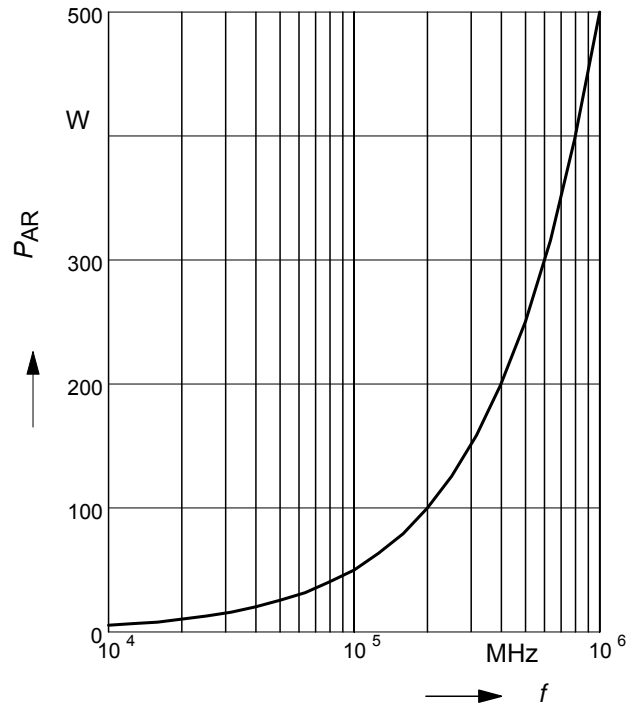

**15 Typ. capacitances**

$$C = f(V_{DS})$$

parameter:  $V_{GS}=0V, f=1 MHz$

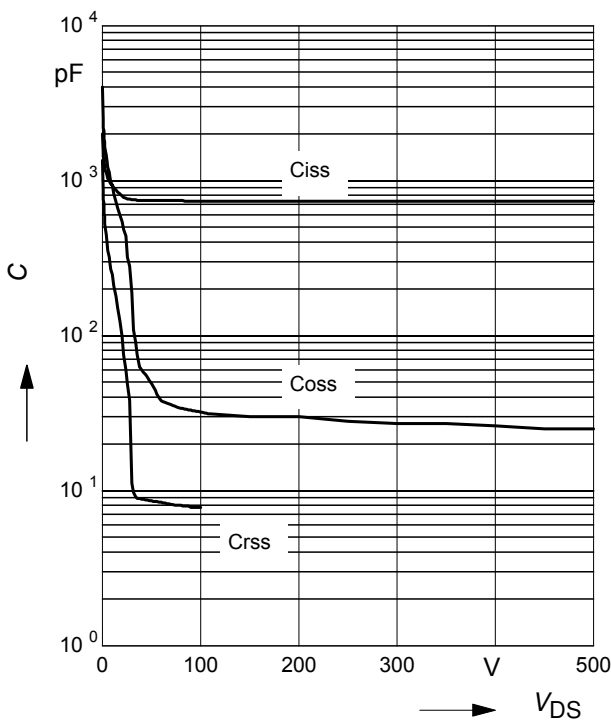

**16 Typ.  $C_{OSS}$  stored energy**

$$E_{OSS} = f(V_{DS})$$

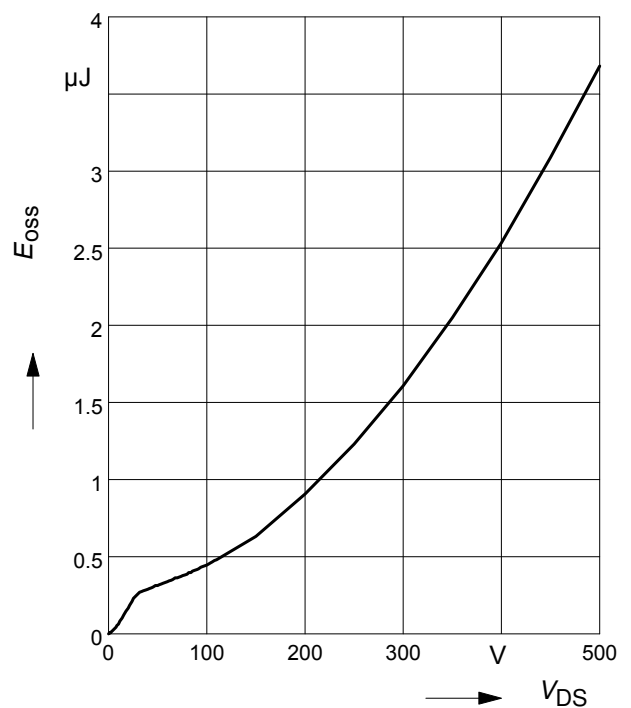



Definition of diodes switching characteristics

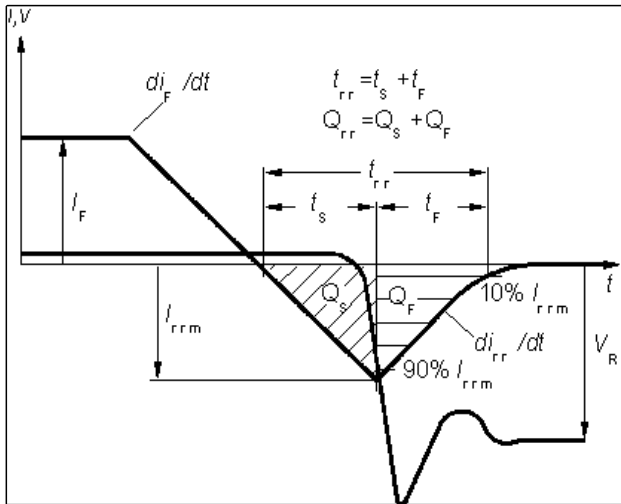

PG-TO252-3-1, PG-TO252-3-11, PG-TO252-3-21 (D-PAK)

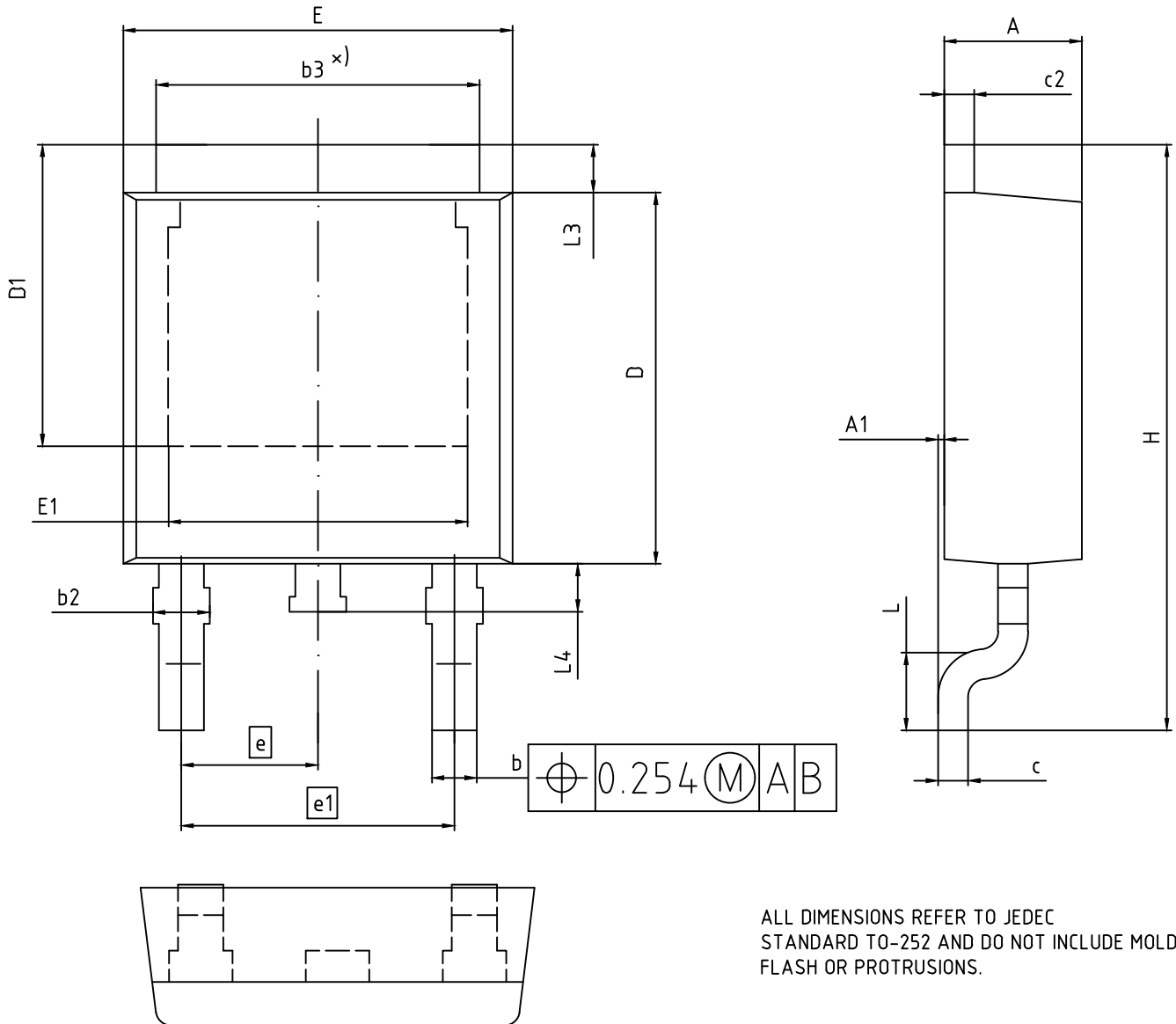

ALL DIMENSIONS REFER TO JEDEC STANDARD TO-252 AND DO NOT INCLUDE MOLD FLASH OR PROTRUSIONS.

| DIMENSION | MILLIMETERS |       |
|-----------|-------------|-------|
|           | MIN.        | MAX.  |
| A         | 2.16        | 2.41  |
| A1        | 0.00        | 0.15  |
| b         | 0.64        | 0.89  |
| b2        | 0.65        | 1.15  |
| b3        | 4.95        | 5.50  |
| c         | 0.46        | 0.61  |
| c2        | 0.40        | 0.98  |
| D         | 5.97        | 6.22  |
| D1        | 5.02        | 5.84  |
| E         | 6.35        | 6.73  |
| E1        | 4.32        | 5.50  |
| e         | 2.29        |       |
| e1        | 4.57        |       |
| N         | 3           |       |
| H         | 9.40        | 10.48 |
| L         | 1.18        | 1.78  |
| L3        | 0.89        | 1.27  |
| L4        | 0.51        | 1.02  |

|                                      |
|--------------------------------------|
| <b>DOCUMENT NO.</b><br>Z8B00003328   |
| <b>REVISION</b><br>07                |
| <b>SCALE:</b><br>10:1<br>0 1 2mm<br> |
| <b>EUROPEAN PROJECTION</b><br>       |
| <b>ISSUE DATE</b><br>01.04.2020      |

## Revision History

SPD08N50C3

**Revision: 2020-05-26, Rev. 2.7**

Previous Revision

| Revision | Date       | Subjects (major changes since last revision) |
|----------|------------|--|
| 2.7      | 2020-05-26 | Update package outline                       |

### Trademarks

All referenced product or service names and trademarks are the property of their respective owners.

### We Listen to Your Comments

Any information within this document that you feel is wrong, unclear or missing at all? Your feedback will help us to continuously improve the quality of this document. Please send your proposal (including a reference to this document) to:

[erratum@infineon.com](mailto:erratum@infineon.com)

### Published by

**Infineon Technologies AG**  
**81726 München, Germany**  
**© 2020 Infineon Technologies AG**  
**All Rights Reserved.**

### Legal Disclaimer

The information given in this document shall in no event be regarded as a guarantee of conditions or characteristics ("Beschaffenheitsgarantie").

With respect to any examples, hints or any typical values stated herein and/or any information regarding the application of the product, Infineon Technologies hereby disclaims any and all warranties and liabilities of any kind, including without limitation warranties of non-infringement of intellectual property rights of any third party.

In addition, any information given in this document is subject to customer's compliance with its obligations stated in this document and any applicable legal requirements, norms and standards concerning customer's products and any use of the product of Infineon Technologies in customer's applications.

The data contained in this document is exclusively intended for technically trained staff. It is the responsibility of customer's technical departments to evaluate the suitability of the product for the intended application and the completeness of the product information given in this document with respect to such application.

### Information

For further information on technology, delivery terms and conditions and prices please contact your nearest Infineon Technologies Office ([www.infineon.com](http://www.infineon.com)).

### Warnings

Due to technical requirements, components may contain dangerous substances. For information on the types in question, please contact the nearest Infineon Technologies Office.

The Infineon Technologies component described in this Data Sheet may be used in life-support devices or systems and/or automotive, aviation and aerospace applications or systems only with the express written approval of Infineon Technologies, if a failure of such components can reasonably be expected to cause the failure of that life-support, automotive, aviation and aerospace device or system or to affect the safety or effectiveness of that device or system. Life support devices or systems are intended to be implanted in the human body or to support and/or maintain and sustain and/or protect human life. If they fail, it is reasonable to assume that the health of the user or other persons may be endangered.

## X-ON Electronics

Largest Supplier of Electrical and Electronic Components

*Click to view similar products for [MOSFET](#) category:*

*Click to view products by [Infineon](#) manufacturer:*

Other Similar products are found below :

[614233C](#) [648584F](#) [IRFD120](#) [JANTX2N5237](#) [FCA20N60\\_F109](#) [FDZ595PZ](#) [2SK2545\(Q,T\)](#) [405094E](#) [423220D](#) [TPCC8103,L1Q\(CM](#)  
[MIC4420CM-TR](#) [VN1206L](#) [614234A](#) [715780A](#) [NTNS3166NZT5G](#) [SSM6J414TU,LF\(T](#) [751625C](#) [BUK954R8-60E](#) [GROUP A 5962-](#)  
[8877003PA](#) [NTE6400](#) [SQJ402EP-T1-GE3](#) [2SK2614\(TE16L1,Q\)](#) [2N7002KW-FAI](#) [DMN1017UCP3-7](#) [EFC2J004NUZTDG](#) [ECH8691-TL-W](#)  
[FCAB21350L1](#) [P85W28HP2F-7071](#) [DMN1053UCP4-7](#) [NTE221](#) [NTE222](#) [NTE2384](#) [NTE2903](#) [NTE2941](#) [NTE2945](#) [NTE2946](#) [NTE2960](#)  
[NTE2967](#) [NTE2969](#) [NTE2976](#) [NTE6400A](#) [NTE2910](#) [NTE2916](#) [NTE2956](#) [NTE2911](#) [DMN2080UCB4-7](#) [TK10A80W,S4X\(S](#)  
[SSM6P54TU,LF](#) [SSM6P69NU,LF](#) [DMP22D4UFO-7B](#)