

Cool MOS™ Power Transistor

Feature

- New revolutionary high voltage technology
- Ultra low gate charge
- Periodic avalanche rated
- Extreme dv/dt rated
- Ultra low effective capacitances
- Improved transconductance
- PG-TO-220-3-31;-3-111: Fully isolated package (2500 VAC; 1 minute)
- Pb-free lead plating; RoHS compliant
- Qualified according to JEDEC⁰⁾ for target applications

$V_{DS} @ T_{jmax}$	560	V
$R_{DS(on)}$	0.6	Ω
I_D	7.6	A

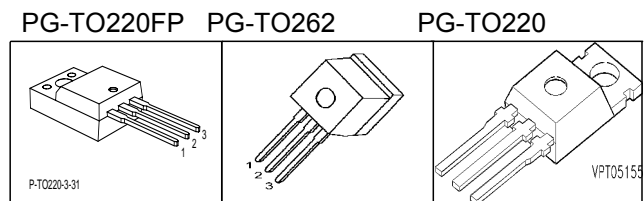

Type	Package	Ordering Code	Marking
SPP08N50C3	PG-TO220	Q67040-S4567	08N50C3
SPI08N50C3	PG-TO262	Q67040-S4568	08N50C3
SPA08N50C3	PG-TO220FP	SP000216306	08N50C3

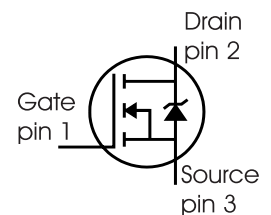

Maximum Ratings

Parameter	Symbol	Value		Unit
		SPP_I	SPA	
Continuous drain current $T_C = 25^\circ\text{C}$ $T_C = 100^\circ\text{C}$	I_D	7.6 4.6	7.6 ¹⁾ 4.6 ¹⁾	A
Pulsed drain current, t_p limited by T_{jmax}	$I_D \text{ puls}$	22.8	22.8	A
Avalanche energy, single pulse $I_D=5.5\text{A}, V_{DD}=50\text{V}$	E_{AS}	230	230	mJ
Avalanche energy, repetitive t_{AR} limited by T_{jmax} ²⁾ $I_D=7.6\text{A}, V_{DD}=50\text{V}$	E_{AR}	0.5	0.5	
Avalanche current, repetitive t_{AR} limited by T_{jmax}	I_{AR}	7.6	7.6	A
Gate source voltage	V_{GS}	± 20	± 20	V
Gate source voltage AC ($f > 1\text{Hz}$)	V_{GS}	± 30	± 30	
Power dissipation, $T_C = 25^\circ\text{C}$	P_{tot}	83	32	W
Operating and storage temperature	T_j, T_{stg}	-55...+150		$^\circ\text{C}$
Reverse diode dv/dt ⁶⁾	dv/dt	15		V/ns

Maximum Ratings

Parameter	Symbol	Value	Unit
Drain Source voltage slope $V_{DS} = 400\text{ V}$, $I_D = 7.6\text{ A}$, $T_j = 125\text{ °C}$	dv/dt	50	V/ns

Thermal Characteristics

Parameter	Symbol	Values			Unit
		min.	typ.	max.	
Thermal resistance, junction - case	R_{thJC}	-	-	1.5	K/W
Thermal resistance, junction - case, FullPAK	R_{thJC_FP}	-	-	3.9	
Thermal resistance, junction - ambient, leaded	R_{thJA}	-	-	62	
Thermal resistance, junction - ambient, FullPAK	R_{thJA_FP}	-	-	80	
Soldering temperature, wavesoldering 1.6 mm (0.063 in.) from case for 10s ³)	T_{sold}	-	-	260	°C

Electrical Characteristics, at $T_j=25\text{ °C}$ unless otherwise specified

Parameter	Symbol	Conditions	Values			Unit
			min.	typ.	max.	
Drain-source breakdown voltage	$V_{(BR)DSS}$	$V_{GS}=0\text{V}$, $I_D=0.25\text{mA}$	500	-	-	V
Drain-Source avalanche breakdown voltage	$V_{(BR)DS}$	$V_{GS}=0\text{V}$, $I_D=7.6\text{A}$	-	600	-	
Gate threshold voltage	$V_{GS(th)}$	$I_D=350\mu\text{A}$, $V_{GS}=V_{DS}$	2.1	3	3.9	
Zero gate voltage drain current	I_{DSS}	$V_{DS}=500\text{V}$, $V_{GS}=0\text{V}$, $T_j=25\text{ °C}$ $T_j=150\text{ °C}$	-	0.5	1	μA
Gate-source leakage current	I_{GSS}	$V_{GS}=20\text{V}$, $V_{DS}=0\text{V}$	-	-	100	
Drain-source on-state resistance	$R_{DS(on)}$	$V_{GS}=10\text{V}$, $I_D=4.6\text{A}$ $T_j=25\text{ °C}$ $T_j=150\text{ °C}$	-	0.5	0.6	Ω
Gate input resistance	R_G	$f=1\text{MHz}$, open drain	-	1.2	-	

Electrical Characteristics

Parameter	Symbol	Conditions	Values			Unit
			min.	typ.	max.	
Transconductance	g_{fs}	$V_{DS} \geq 2 \cdot I_D \cdot R_{DS(on)max}$, $I_D = 4.6A$	-	6	-	S
Input capacitance	C_{iss}	$V_{GS} = 0V$, $V_{DS} = 25V$, $f = 1MHz$	-	750	-	pF
Output capacitance	C_{oss}		-	350	-	
Reverse transfer capacitance	C_{rss}		-	12	-	
Effective output capacitance, ⁴⁾ energy related	$C_{o(er)}$	$V_{GS} = 0V$, $V_{DS} = 400$	-	56	-	
Effective output capacitance, ⁵⁾ time related	$C_{o(tr)}$		-	30	-	
Turn-on delay time	$t_{d(on)}$	$V_{DD} = 380V$, $V_{GS} = 0/10V$, $I_D = 7.6A$, $R_G = 12\Omega$	-	6	-	ns
Rise time	t_r		-	5	-	
Turn-off delay time	$t_{d(off)}$		-	60	-	
Fall time	t_f		-	7	-	

Gate Charge Characteristics

Gate to source charge	Q_{gs}	$V_{DD} = 400V$, $I_D = 7.6A$	-	3	-	nC
Gate to drain charge	Q_{gd}		-	17	-	
Gate charge total	Q_g	$V_{DD} = 400V$, $I_D = 7.6A$, $V_{GS} = 0$ to $10V$	-	32	-	
Gate plateau voltage	$V_{(plateau)}$	$V_{DD} = 400V$, $I_D = 7.6A$	-	5	-	V

⁰J-STD20 and JESD22

¹Limited only by maximum temperature

²Repetitive avalanche causes additional power losses that can be calculated as $P_{AV} = E_{AR} \cdot f$.

³Soldering temperature for TO-263: 220°C, reflow

⁴ $C_{o(er)}$ is a fixed capacitance that gives the same stored energy as C_{oss} while V_{DS} is rising from 0 to 80% V_{DSS} .

⁵ $C_{o(tr)}$ is a fixed capacitance that gives the same charging time as C_{oss} while V_{DS} is rising from 0 to 80% V_{DSS} .

⁶ $I_{SD} \leq I_D$, $di/dt \leq 400A/\mu s$, $V_{DClink} = 400V$, $V_{peak} < V_{BR, DSS}$, $T_j < T_{j,max}$.

Identical low-side and high-side switch.

Electrical Characteristics

Parameter	Symbol	Conditions	Values			Unit
			min.	typ.	max.	
Inverse diode continuous forward current	I_S	$T_C=25^\circ\text{C}$	-	-	7.6	A
Inverse diode direct current, pulsed	I_{SM}		-	-	22.8	
Inverse diode forward voltage	V_{SD}	$V_{GS}=0\text{V}, I_F=I_S$	-	1	1.2	V
Reverse recovery time	t_{rr}	$V_R=400\text{V}, I_F=I_S,$	-	370	-	ns
Reverse recovery charge	Q_{rr}	$di_F/dt=100\text{A}/\mu\text{s}$	-	3.6	-	μC
Peak reverse recovery current	I_{rrm}		-	25	-	A
Peak rate of fall of reverse recovery current	di_{rr}/dt	$T_j=25^\circ\text{C}$	-	700	-	$\text{A}/\mu\text{s}$

Typical Transient Thermal Characteristics

Symbol	Value		Unit	Symbol	Value		Unit
	SPP_I	SPA			SPP_I	SPA	
R_{th1}	0.024	0.024	K/W	C_{th1}	0.00012	0.00012	Ws/K
R_{th2}	0.046	0.046		C_{th2}	0.0004578	0.0004578	
R_{th3}	0.085	0.085		C_{th3}	0.000645	0.000645	
R_{th4}	0.308	0.195		C_{th4}	0.001867	0.001867	
R_{th5}	0.317	0.45		C_{th5}	0.004795	0.007558	
R_{th6}	0.112	2.511		C_{th6}	0.045	0.412	

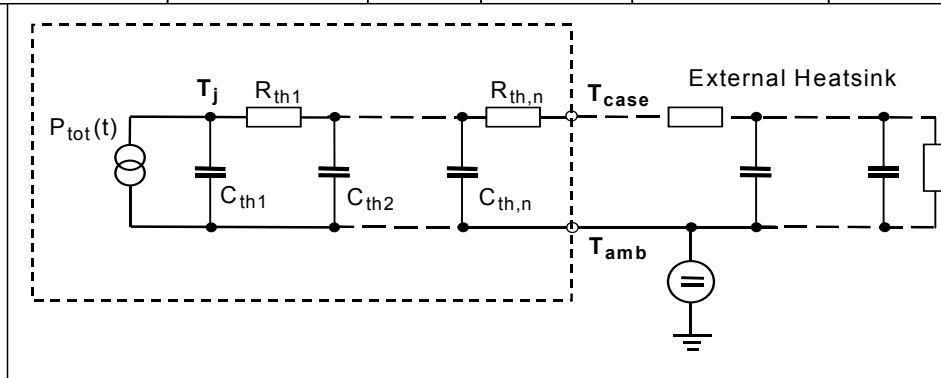

1 Power dissipation

$$P_{tot} = f(T_C)$$

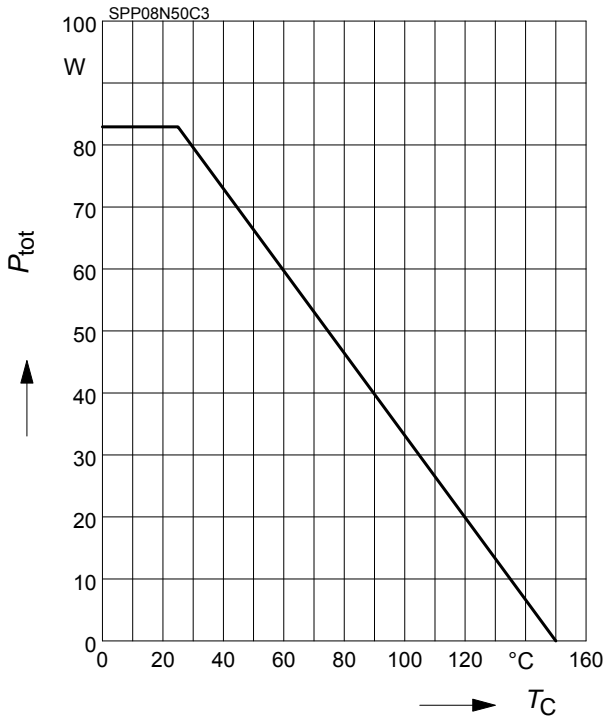

2 Power dissipation FullPAK

$$P_{tot} = f(T_C)$$

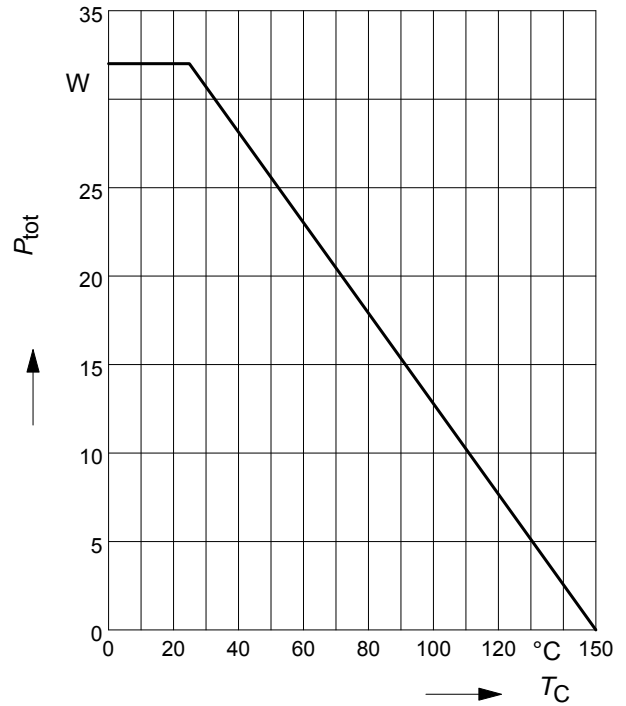

3 Safe operating area

$$I_D = f(V_{DS})$$

parameter : $D = 0$, $T_C = 25^\circ\text{C}$

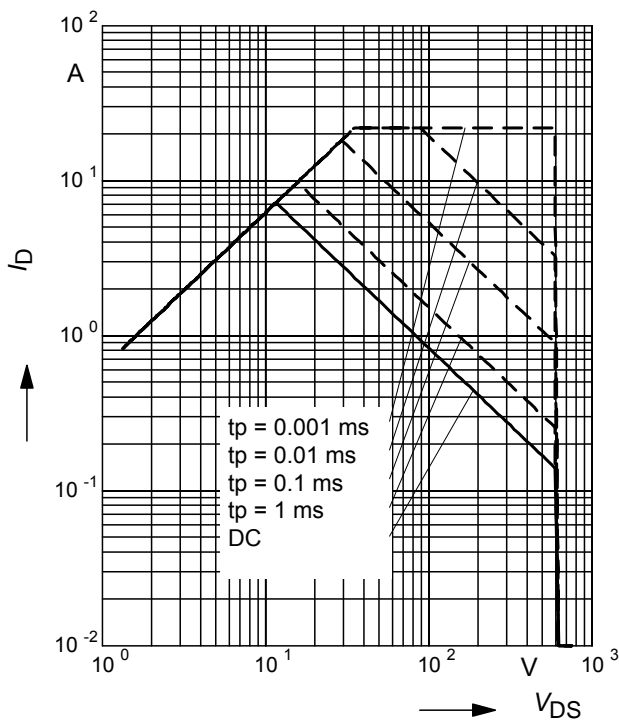

4 Safe operating area FullPAK

$$I_D = f(V_{DS})$$

parameter: $D = 0$, $T_C = 25^\circ\text{C}$

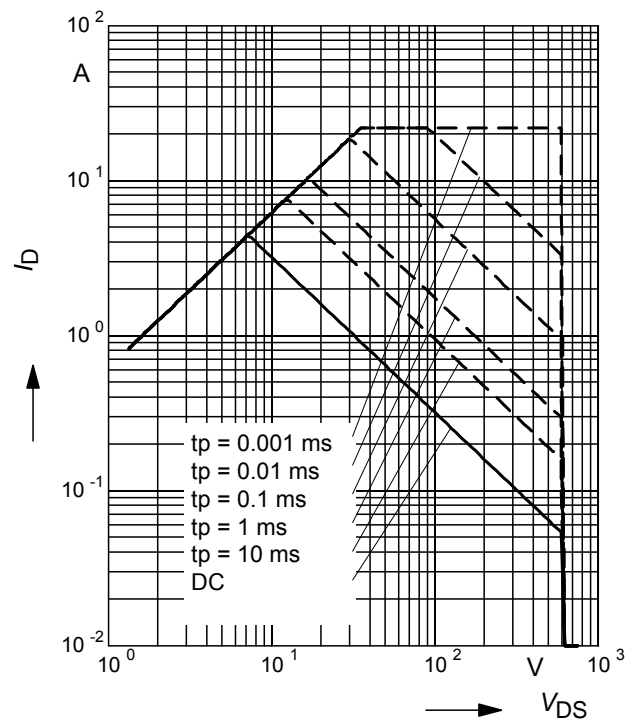

5 Transient thermal impedance

$$Z_{thJC} = f(t_p)$$

parameter: $D = t_p/T$

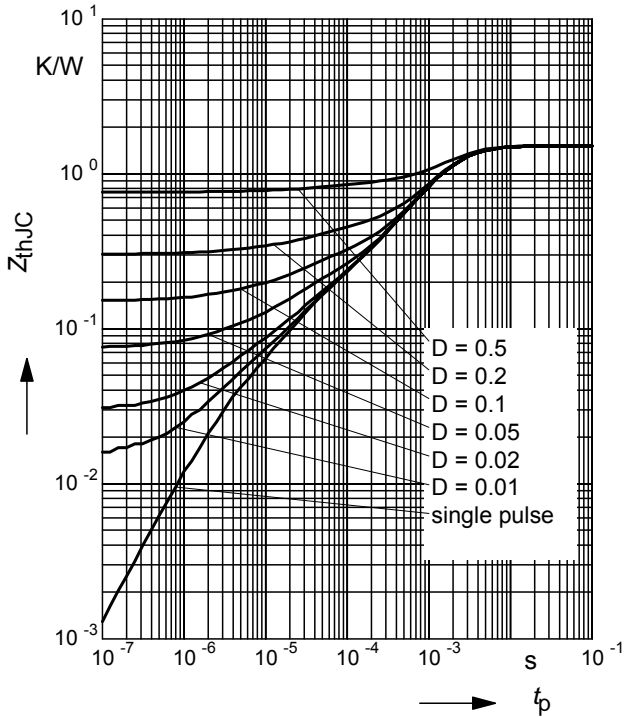

6 Transient thermal impedance FullPAK

$$Z_{thJC} = f(t_p)$$

parameter: $D = t_p/t$

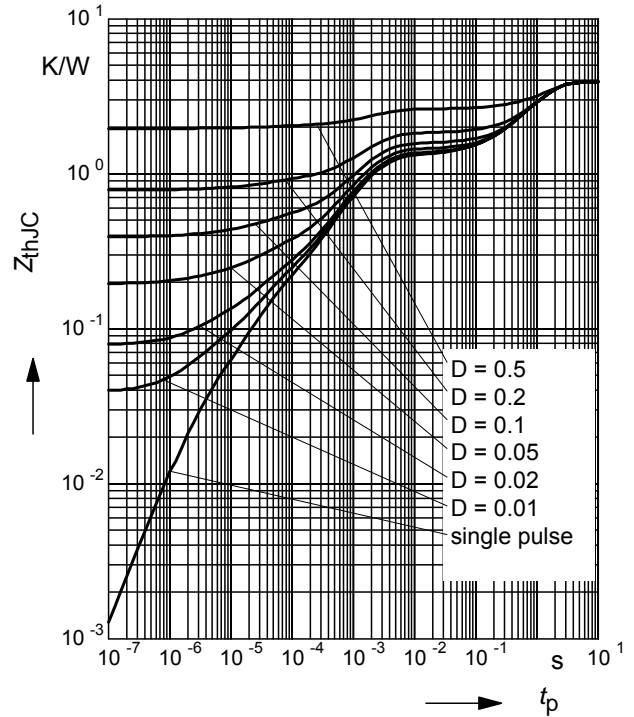

7 Typ. output characteristic

$$I_D = f(V_{DS}); T_j = 25^\circ\text{C}$$

parameter: $t_p = 10 \mu\text{s}, V_{GS}$

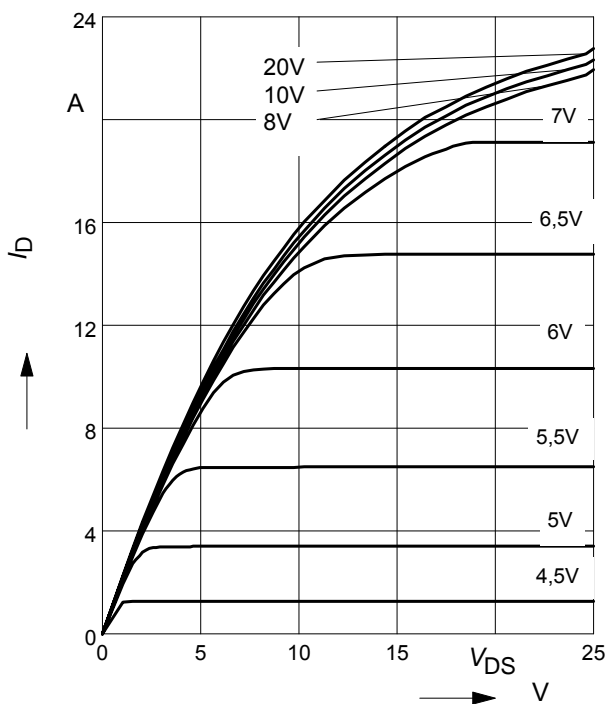

8 Typ. output characteristic

$$I_D = f(V_{DS}); T_j = 150^\circ\text{C}$$

parameter: $t_p = 10 \mu\text{s}, V_{GS}$

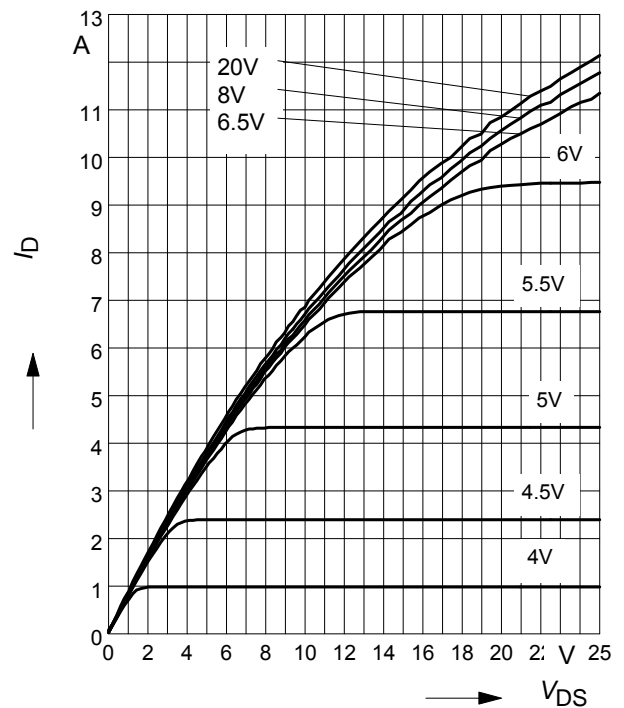

9 Typ. drain-source on resistance

$$R_{DS(on)} = f(I_D)$$

parameter: $T_j = 150^\circ\text{C}$, V_{GS}

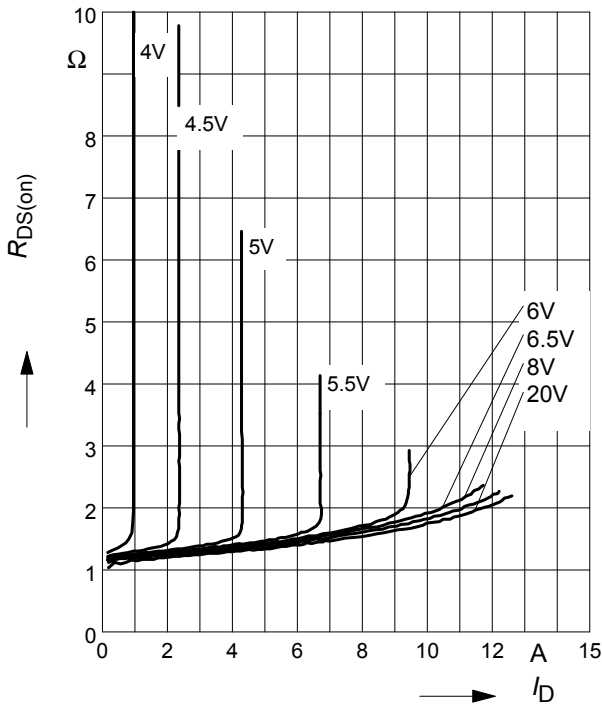

10 Drain-source on-state resistance

$$R_{DS(on)} = f(T_j)$$

parameter: $I_D = 4.6\text{ A}$, $V_{GS} = 10\text{ V}$

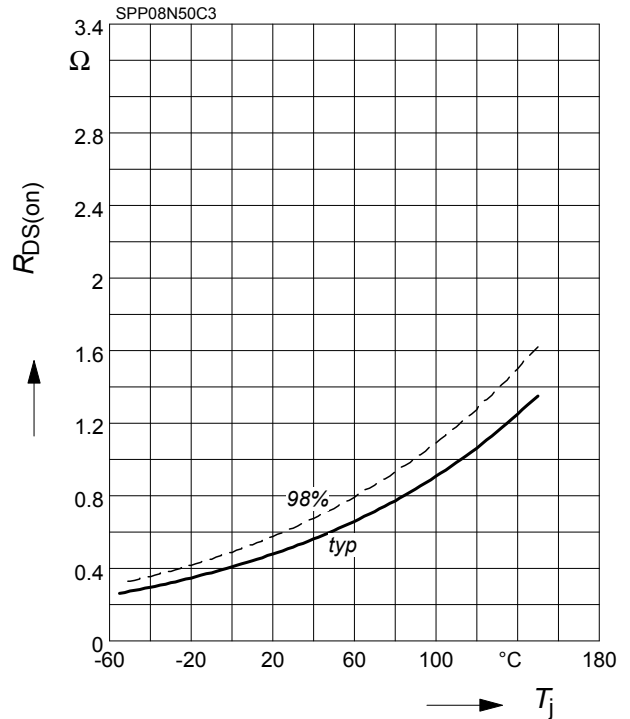

11 Typ. transfer characteristics

$$I_D = f(V_{GS}); V_{DS} \geq 2 \times I_D \times R_{DS(on)\text{max}}$$

parameter: $t_p = 10\ \mu\text{s}$

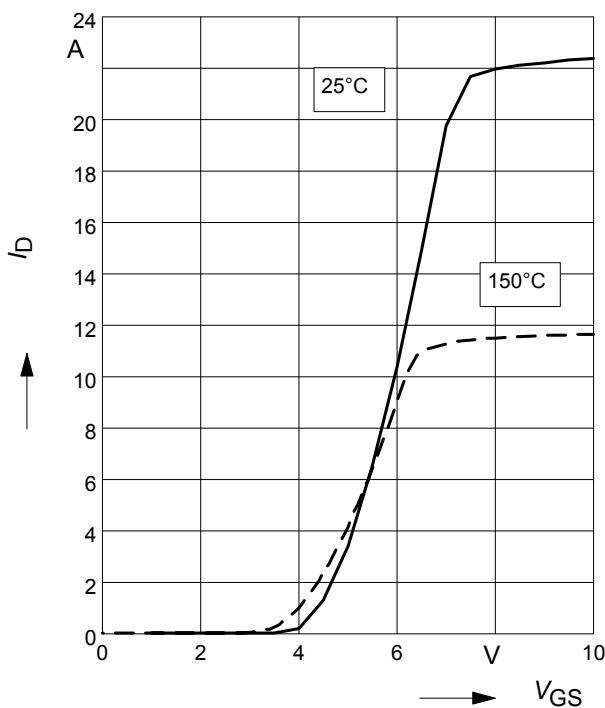

12 Typ. gate charge

$$V_{GS} = f(Q_{\text{Gate}})$$

parameter: $I_D = 7.6\text{ A pulsed}$

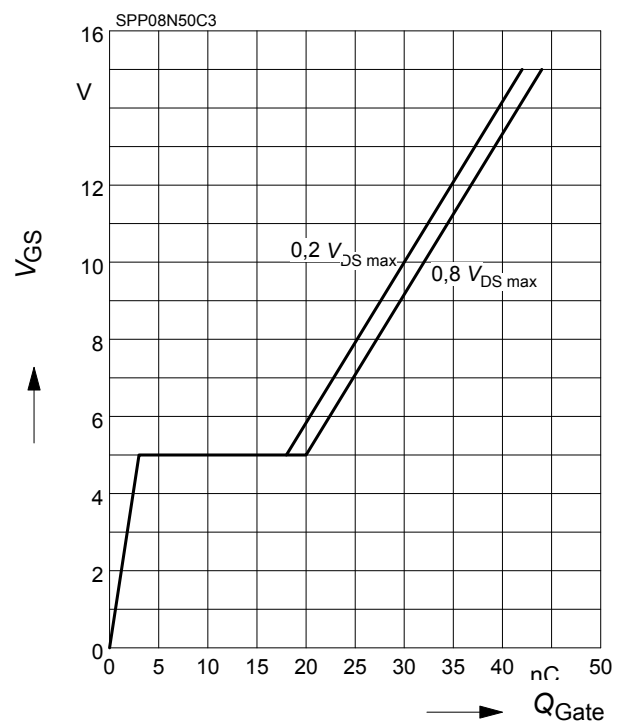

13 Forward characteristics of body diode

$$I_F = f(V_{SD})$$

parameter: T_j , $t_p = 10 \mu s$

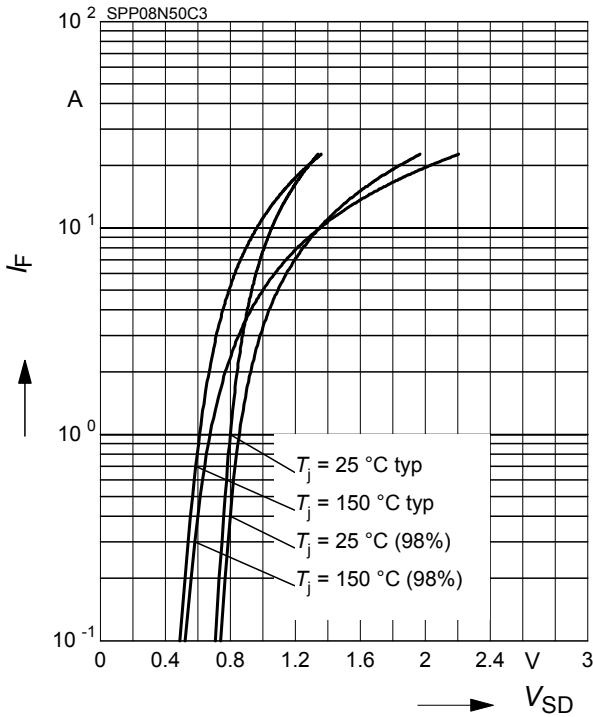

14 Avalanche SOA

$$I_{AR} = f(t_{AR})$$

par.: $T_j \leq 150 \text{ °C}$

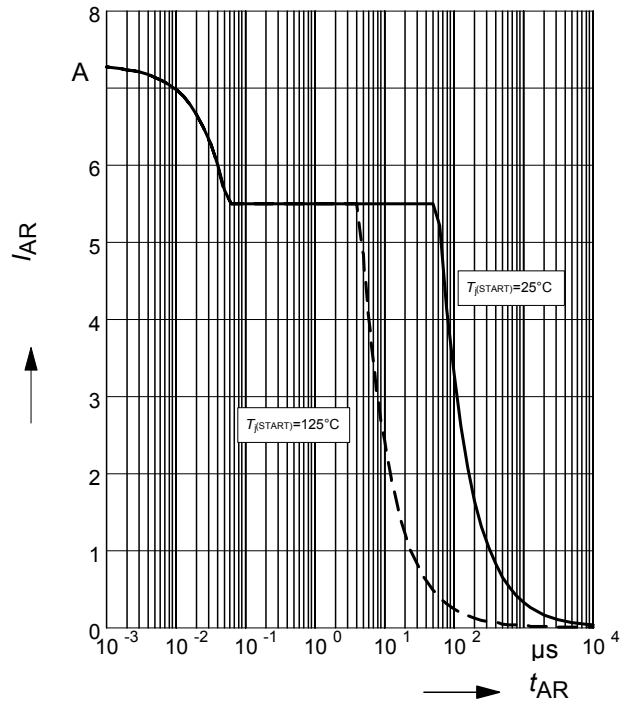

15 Avalanche energy

$$E_{AS} = f(T_j)$$

par.: $I_D = 5.5 \text{ A}$, $V_{DD} = 50 \text{ V}$

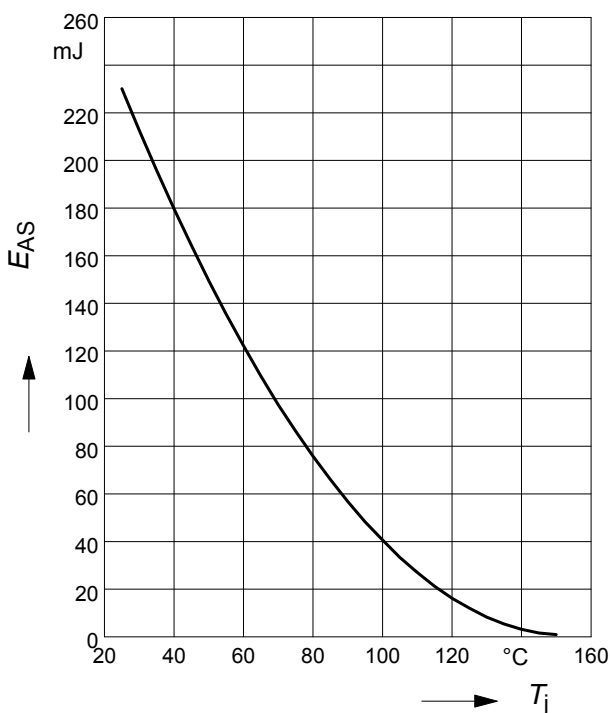

16 Drain-source breakdown voltage

$$V_{(BR)DSS} = f(T_j)$$

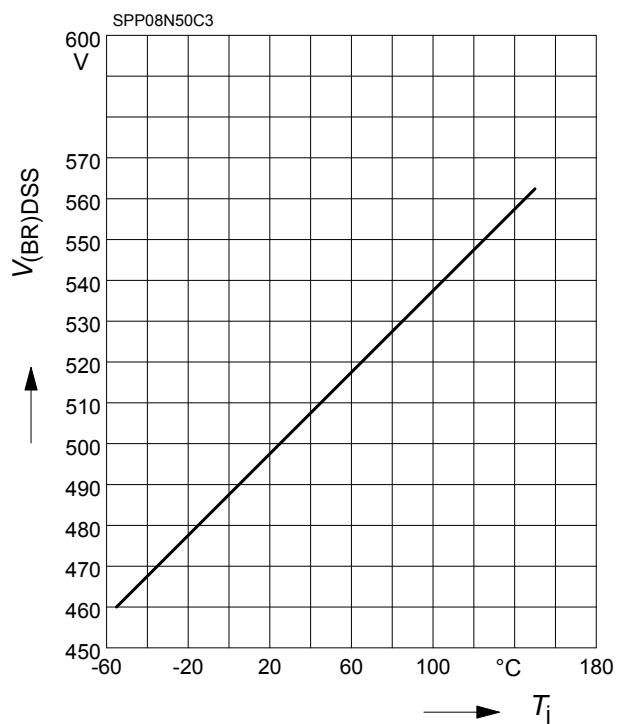

17 Avalanche power losses

$$P_{AR} = f(f)$$

parameter: $E_{AR}=0.5\text{mJ}$

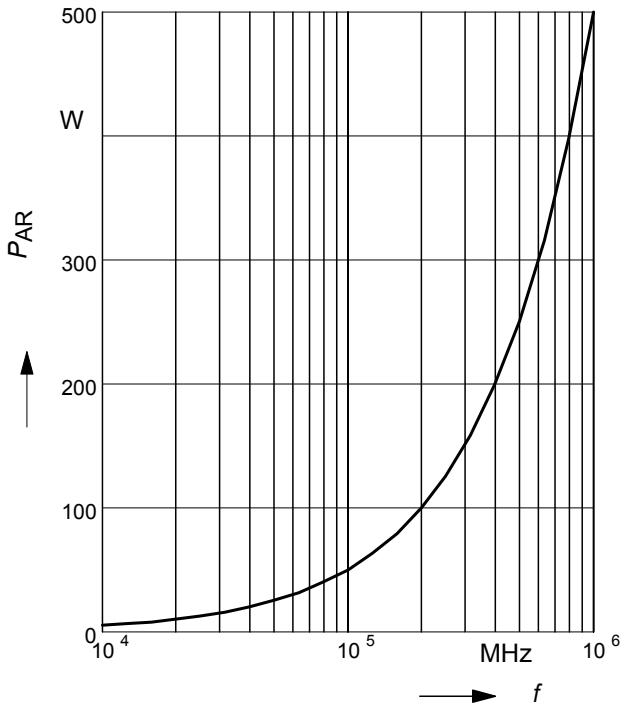

18 Typ. capacitances

$$C = f(V_{DS})$$

parameter: $V_{GS}=0\text{V}$, $f=1\text{ MHz}$

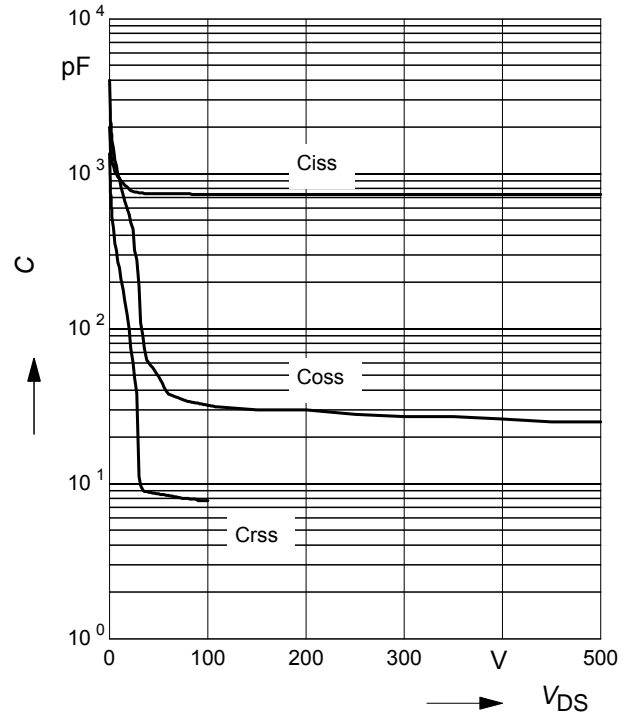

19 Typ. C_{OSS} stored energy

$$E_{OSS} = f(V_{DS})$$

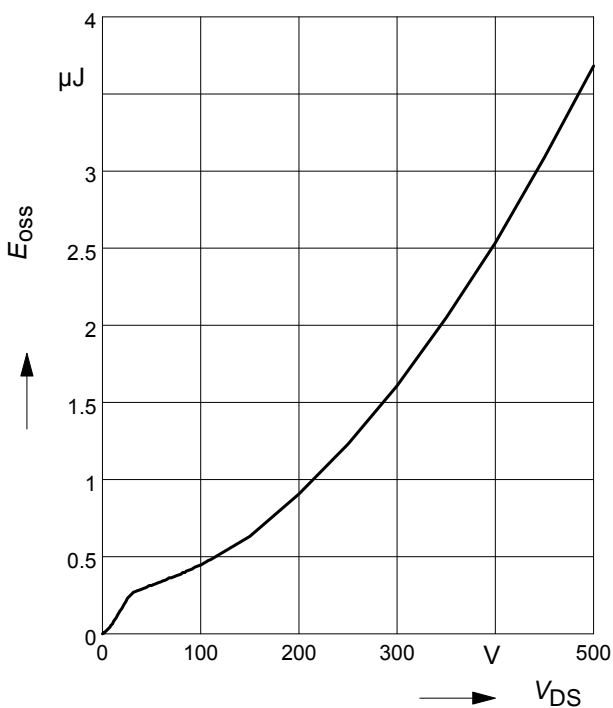

Definition of diodes switching characteristics



PG-TO220-3-1, PG-TO220-3-21

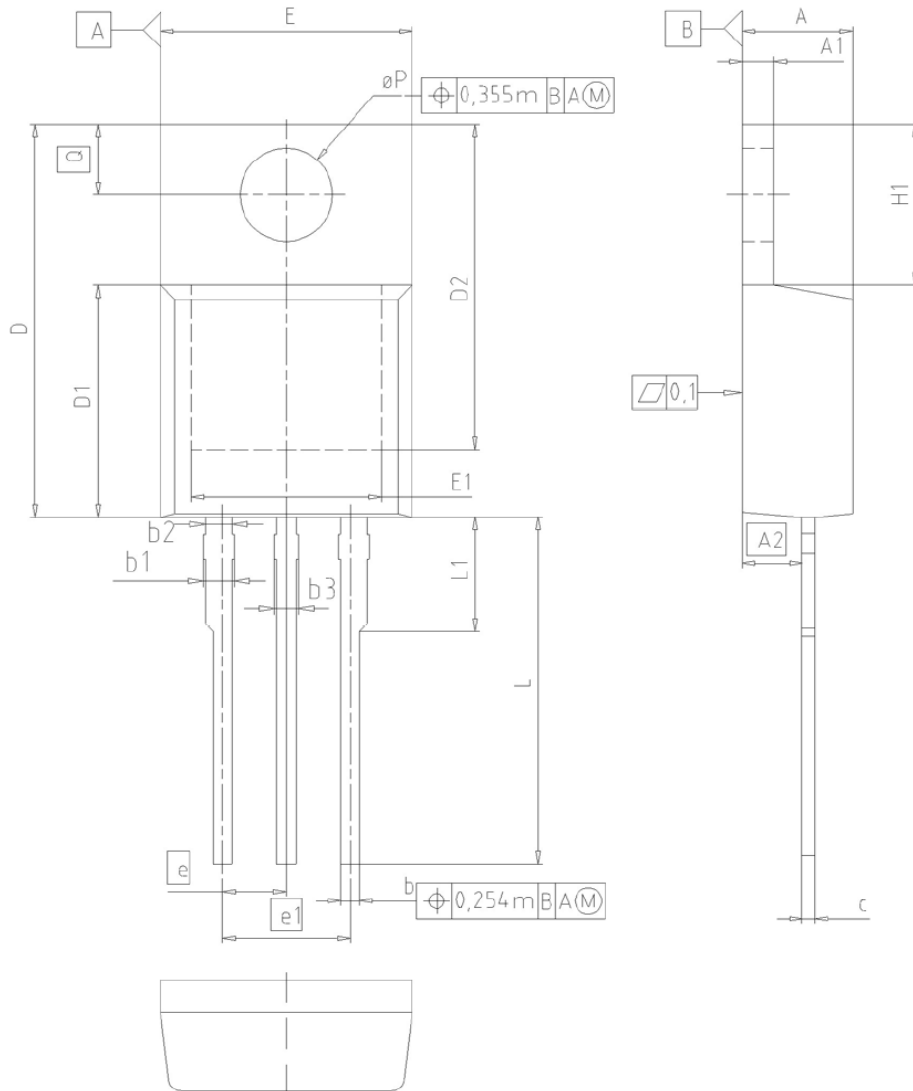

DIM	MILLIMETERS		INCHES	
	MIN	MAX	MIN	MAX
A	4.30	4.57	0.169	0.180
A1	1.17	1.40	0.046	0.055
A2	2.15	2.72	0.085	0.107
b	0.65	0.86	0.026	0.034
b1	0.95	1.40	0.037	0.055
b2	0.95	1.15	0.037	0.045
b3	0.65	1.15	0.026	0.045
c	0.33	0.60	0.013	0.024
D	14.81	15.95	0.583	0.628
D1	8.51	9.45	0.335	0.372
D2	12.19	13.10	0.480	0.516
E	9.70	10.36	0.382	0.408
E1	6.50	8.60	0.256	0.339
e	2.54		0.100	
e1	5.08		0.200	
N	3		3	
H1	5.90	6.90	0.232	0.272
L	13.00	14.00	0.512	0.551
L1	-	4.80	-	0.189
øP	3.60	3.89	0.142	0.153
Q	2.60	3.00	0.102	0.118

DOCUMENT NO.
Z8B00003318

SCALE

EUROPEAN PROJECTION

ISSUE DATE
23-08-2007

REVISION
05

PG-TO-220-3-31/3-111 Fully isolated package (2500VAC; 1 minute)

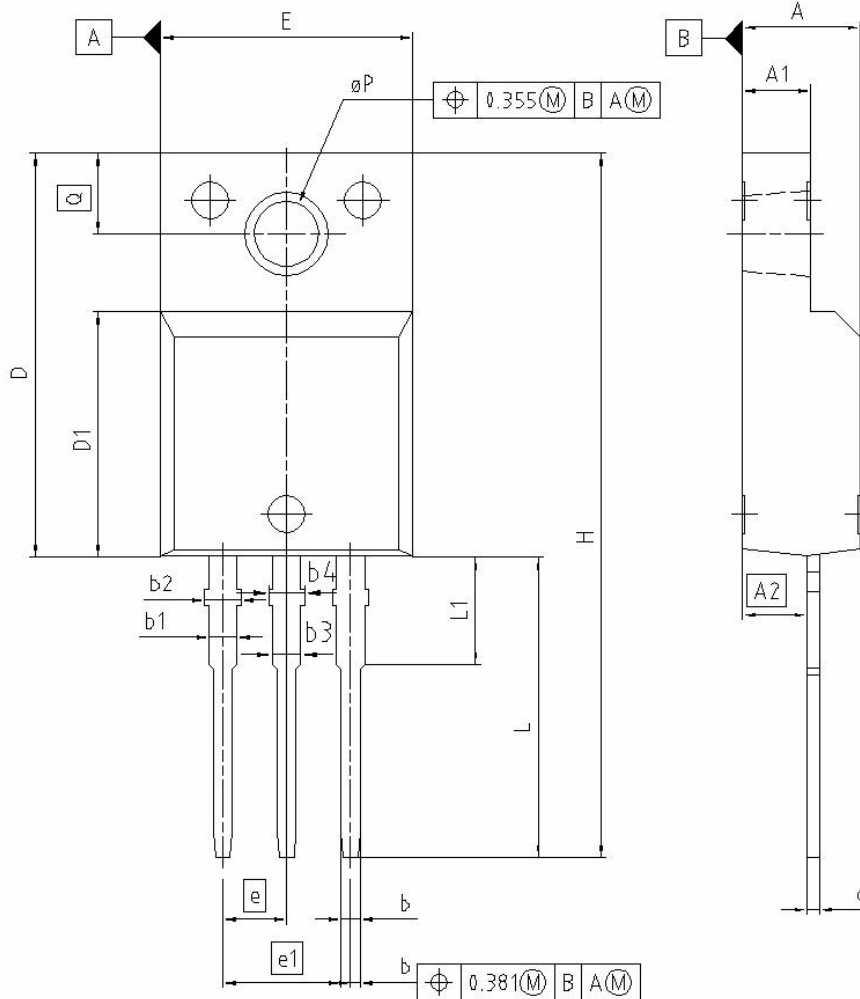

DIM	MILLIMETERS		INCHES	
	MIN	MAX	MIN	MAX
A	4.55	4.85	0.179	0.191
A1	2.55	2.85	0.100	0.112
A2	2.42	2.72	0.095	0.107
b	0.65	0.85	0.026	0.033
b1	0.95	1.33	0.037	0.052
b2	0.95	1.51	0.037	0.059
b3	0.65	1.33	0.026	0.052
b4	0.65	1.51	0.026	0.059
c	0.40	0.63	0.016	0.025
D	15.85	16.15	0.624	0.636
D1	9.53	9.83	0.375	0.387
E	10.35	10.65	0.407	0.419
e	2.54		0.100	
e1	5.08		0.200	
N	3		3	
H	29.45	29.75	1.159	1.171
L	13.45	13.75	0.530	0.541
L1	3.15	3.45	0.124	0.136
ϕP	2.95	3.20	0.116	0.126
Q	3.15	3.50	0.124	0.138

REFERENCE
/..

SCALE
0 2.5 5mm

EUROPEAN PROJECTION

ISSUE DATE
08-01-2007

FILE
TO220_2

PG-TO262-3-1, PG-TO262-3-21 (I²-PAK)

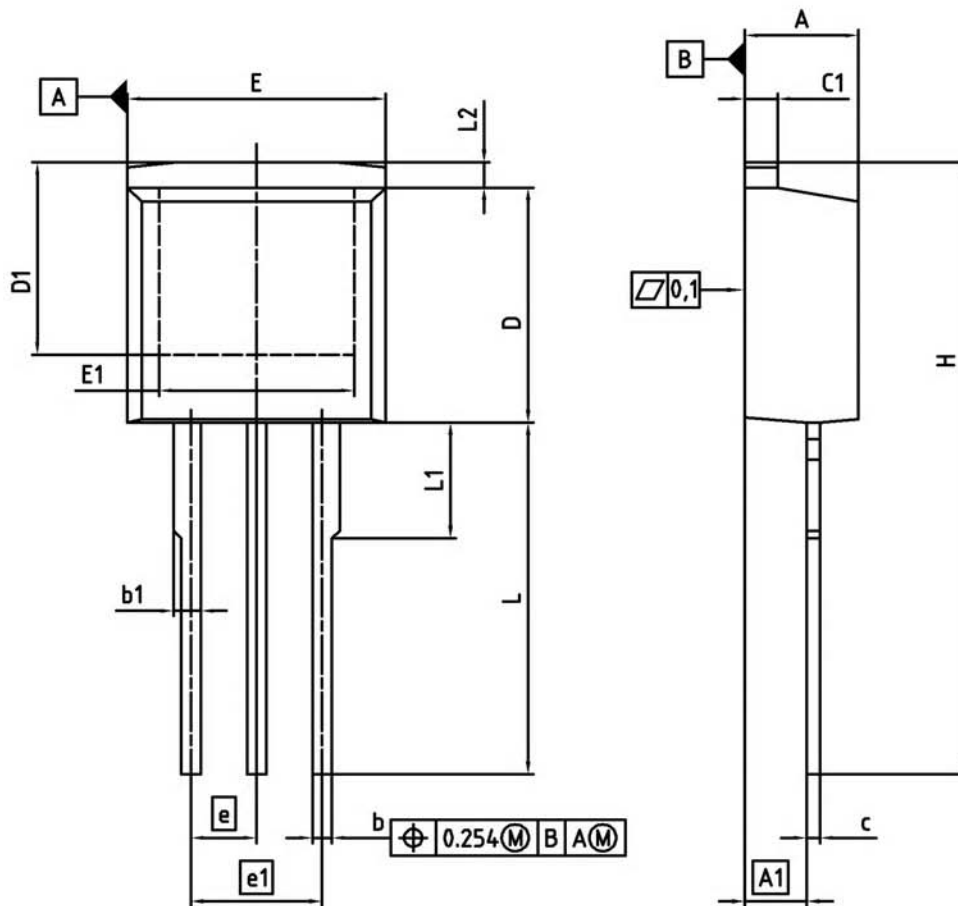

DIM	MILLIMETERS		INCHES	
	MIN	MAX	MIN	MAX
A	4.300	4.572	0.169	0.180
A1	2.150	2.718	0.085	0.107
b	0.650	0.864	0.026	0.034
b1	0.635	1.400	0.025	0.055
c	0.330	0.600	0.013	0.024
c1	1.170	1.400	0.046	0.055
D	8.509	9.450	0.335	0.372
D1	6.900	-	0.272	-
E	9.700	10.363	0.382	0.408
E1	6.500	8.600	0.256	0.339
e	2.540		0.100	
e1	5.080		0.200	
N	3		3	
L	13.000	14.000	0.512	0.551
L1	-	4.800	-	0.189
L2	-	1.727	-	0.068

REFERENCE
JEDEC TO262

EUROPEAN PROJECTION

ISSUE DATE
05-05-2006

FILE
TO262_1

Published by
Infineon Technologies AG
81726 Munich, Germany
© 2009 Infineon Technologies AG
All Rights Reserved.

Legal Disclaimer

The information given in this document shall in no event be regarded as a guarantee of conditions or characteristics. With respect to any examples or hints given herein, any typical values stated herein and/or any information regarding the application of the device, Infineon Technologies hereby disclaims any and all warranties and liabilities of any kind, including without limitation, warranties of non-infringement of intellectual property rights of any third party.

Information

For further information on technology, delivery terms and conditions and prices, please contact the nearest Infineon Technologies Office (www.infineon.com).

Warnings

Due to technical requirements, components may contain dangerous substances. For information on the types in question, please contact the nearest Infineon Technologies Office.

Infineon Technologies components may be used in life-support devices or systems only with the express written approval of Infineon Technologies, if a failure of such components can reasonably be expected to cause the failure of that life-support device or system or to affect the safety or effectiveness of that device or system. Life support devices or systems are intended to be implanted in the human body or to support and/or maintain and sustain and/or protect human life. If they fail, it is reasonable to assume that the health of the user or other persons may be endangered.

X-ON Electronics

Largest Supplier of Electrical and Electronic Components

Click to view similar products for [MOSFET](#) category:

Click to view products by [Infineon](#) manufacturer:

Other Similar products are found below :

[614233C](#) [648584F](#) [IRFD120](#) [JANTX2N5237](#) [FCA20N60_F109](#) [FDZ595PZ](#) [2SK2545\(Q,T\)](#) [405094E](#) [423220D](#) [TPCC8103,L1Q\(CM](#)
[MIC4420CM-TR](#) [VN1206L](#) [614234A](#) [715780A](#) [NTNS3166NZT5G](#) [SSM6J414TU,LF\(T](#) [751625C](#) [BUK954R8-60E](#) [GROUP A 5962-](#)
[8877003PA](#) [NTE6400](#) [SQJ402EP-T1-GE3](#) [2SK2614\(TE16L1,Q\)](#) [2N7002KW-FAI](#) [DMN1017UCP3-7](#) [EFC2J004NUZTDG](#) [ECH8691-TL-W](#)
[FCAB21350L1](#) [P85W28HP2F-7071](#) [DMN1053UCP4-7](#) [NTE221](#) [NTE222](#) [NTE2384](#) [NTE2903](#) [NTE2941](#) [NTE2945](#) [NTE2946](#) [NTE2960](#)
[NTE2967](#) [NTE2969](#) [NTE2976](#) [NTE6400A](#) [NTE2910](#) [NTE2916](#) [NTE2956](#) [NTE2911](#) [DMN2080UCB4-7](#) [TK10A80W,S4X\(S](#)
[SSM6P69NU,LF](#) [DMP22D4UFO-7B](#) [DMN1006UCA6-7](#)