

Power Management & Supply: DC/DC Selection Guide

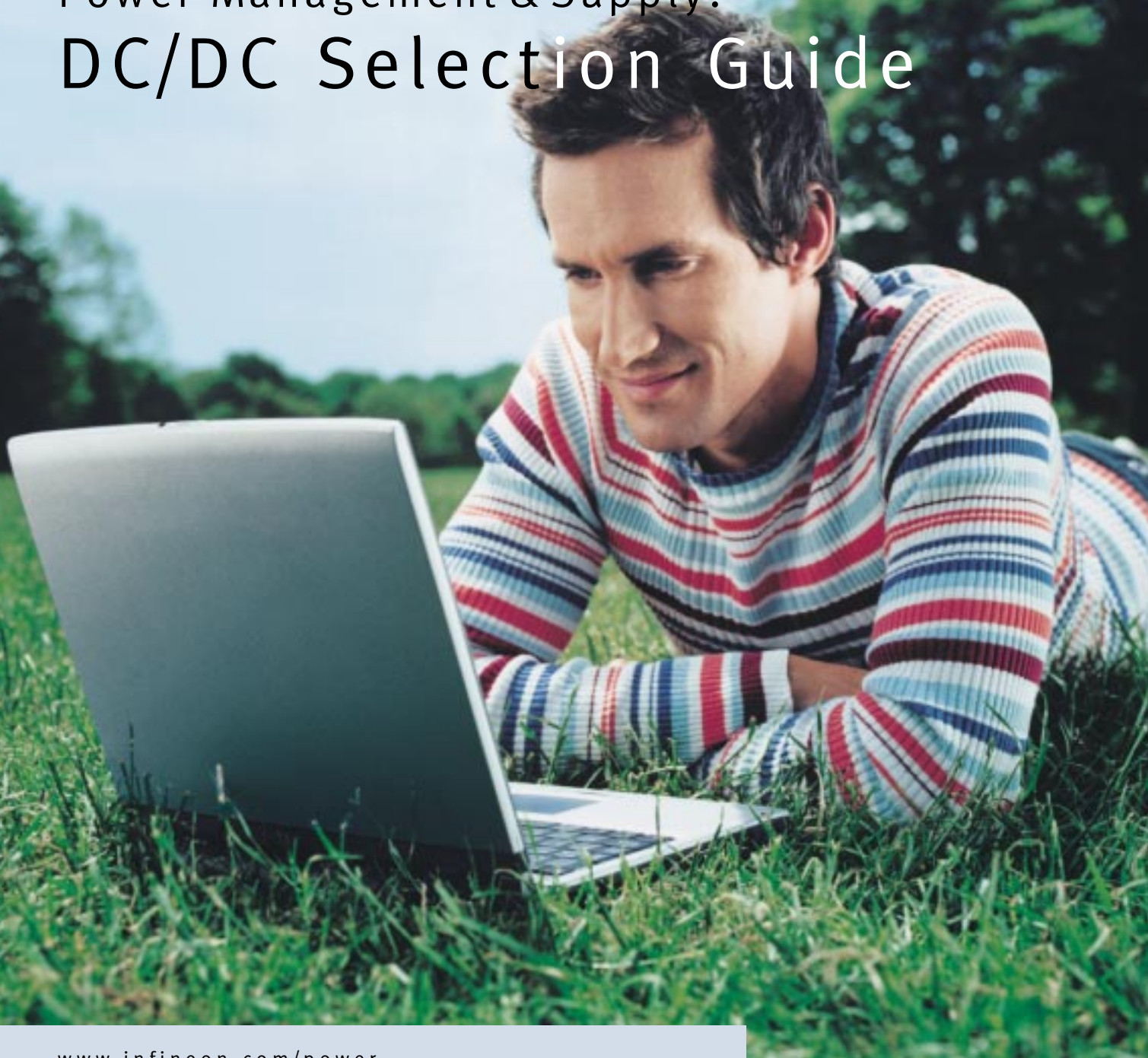

www.infineon.com/power



Never stop thinking.

Introduction

DC/DC CONVERSION plays a critical role in today's applications such as desktop and notebook computers, consumer equipment e.g. DVD players and set-top boxes or portable electronics, such as PDAs, MP3 players to mention but a few.

ALL THESE APPLICATIONS make ever-increasing demands on the internal power conversion; power losses must be reduced and efficiency improved, translating into less heat and a longer battery lifetime. At the same time devices are constantly shrinking in size, increasing the power density.

WE CAN HELP you out. Our OptiMOS² power MOSFET technology reduces the resistive and switching loss components significantly. The gate charge – and consequently the “figure-of-merit” of our devices – has become the new industry benchmark. More importantly, the output charge is reduced to extremely low levels, minimizing the total switching losses for a given output current. At the same time, best-in-class power MOSFETs with an on-resistance in the range of 3 mΩ and below, are now possible, making new circuit concepts and applications possible. New packages like our SS08 show strongly reduced package resistances, and – furthermore – parasitic inductances. Coupled with excellent thermal performance, our new 30 V OptiMOS² products allow for new levels of power conversion efficiency especially in portable applications. For applications with space constraints, a large product portfolio of devices in smaller packages is available, including dual and complementary devices.

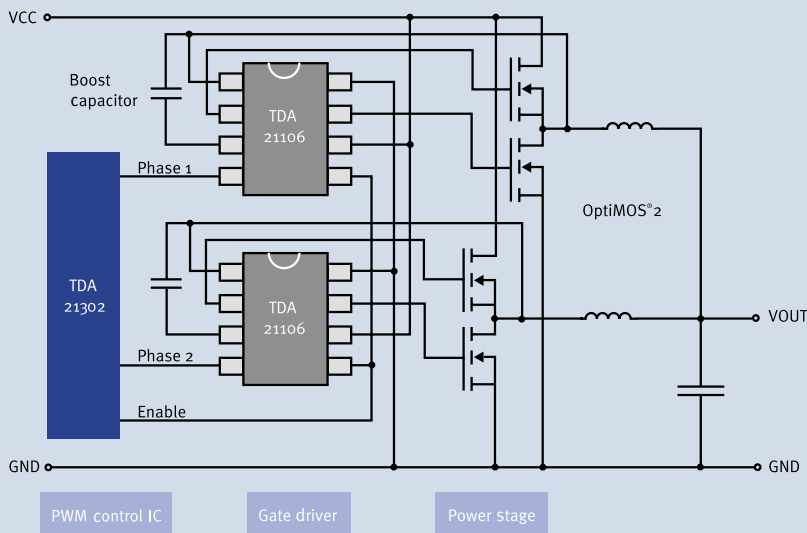

IN A DC/DC CONVERTER solution all components must be optimized in order to achieve the highest efficiency and power density, at a given cost. Our low-voltage control ICs and gate drivers are designed for optimum performance, along with new ideas for control and protection functions.



Contents

ICs

Integrated Switch	4
PWM Control IC	4
Gate Driver	4

Discretes

N-Channel MOSFETs, 25 to 240 V (OptiMOS [®] 2, OptiMOS [®] , Standard MOS)	6
P-Channel MOSFETs, -20 to -240 V (OptiMOS [®] -P, Standard MOS)	12
Complementary P/N Enhancement	13
Alphanumeric Listing	14
Packages	16

Integrated Switch

TDA 21201

- Integrated switch = Gate driver + power MOSFETs
- Used for DC/DC conversion for CPU power supply on PC mainboards
- Can also be used for any voltage conversion with high V_{IN} / V_{OUT} ratio
- Gate driver functionality: Overtemperature protection, cross-current prevention, power-down
- Package: P-TO220-7 / D²-PAK
SMD version: TDA 21201-B7
Straight lead version: TDA 21201-P7
Staggered lead version: TDA 21201-S7
- Supply voltage 12 V
- Current rating depending on cooling:
30 A (Heatsink), 18 A (SMD)
- Efficiency > 85% can be reached
- Simple board layout
- Volume production started

PWM Control IC

TDA 21302

- 2 – 4 Phase PWM conversion with automatic phase selection
- VRD10.x compliant
- Active droop compensation for fast load response
- Smooth Vcore voltage transition during the VID on-the-fly
- Power stage thermal balance by Sync. FET $R_{DS(on)}$ current sense technique
- Hiccup mode over current protection
- Programmable switching frequency (50 KHz – 400 KHz per phase)
- Under voltage lockout
- Soft-start
- High output ripple frequency times numbers of working channels
- Package P-DSO-32

Gate Driver

TDA 21102 / TDA 21106

- High-speed MOSFET driver in single & dual version
- Drives two N-Channel MOS in half-bridge configuration (buck converter)
- Supply voltage 12 V
- Increased current handling capability for efficient high-speed designs:
Gate drive peak current 2 A
- Switching frequency > 1 MHz
- Functionality: Cross-current prevention, shut-down mode
- Package P-DSO-8 (TDA 21106), P-DSO-14 (TDA 21102)
- Compatible with Intersil HIP6601 and 6602
- Can be used with all standard PWM controllers
- No bootstrap diode required

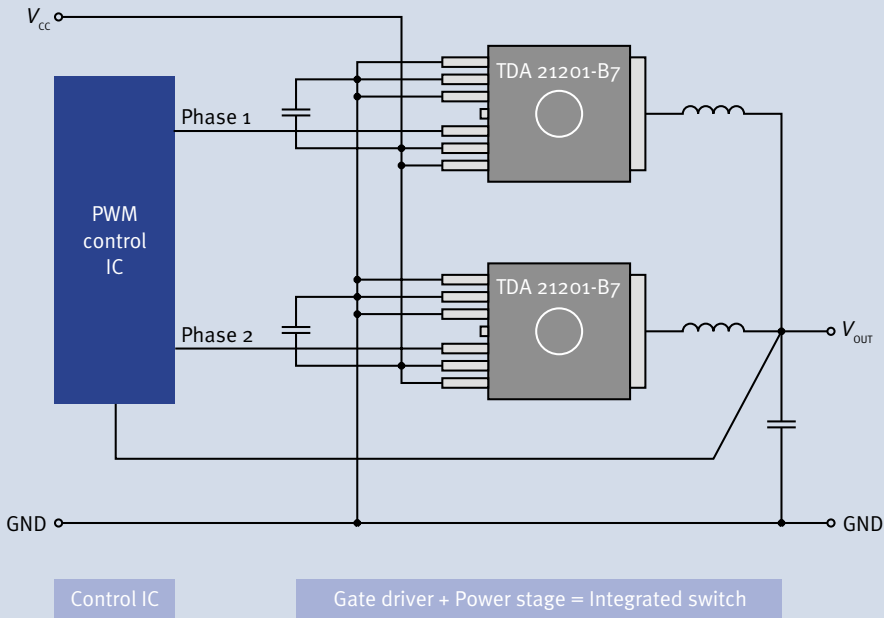

Application example: integrated switch application circuit (2-phase solution) with a simple and clean layout

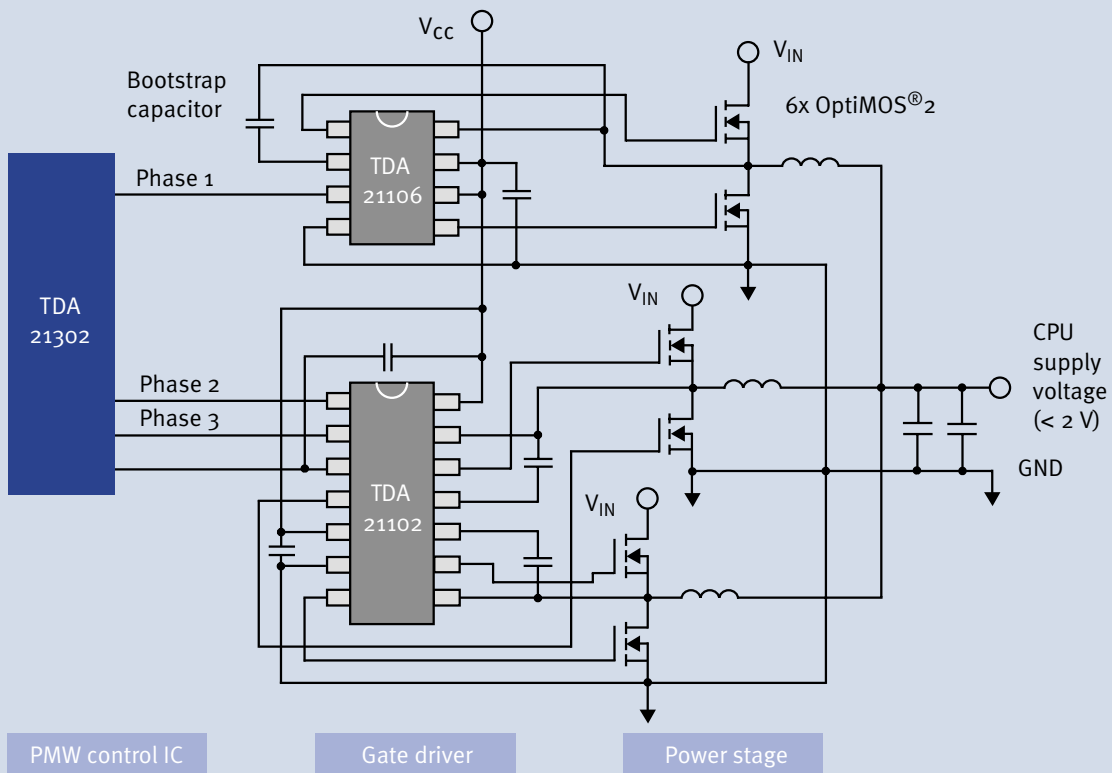

Application example: stand-alone gate driver / application circuit (3-phase solution with single and dual gate driver)

N-Channel MOSFETs

N-Channel 25 V (OptiMOS[®] 2)

Package	$R_{DS(on) \text{ max. [m}\Omega]$ @ $V_{GS} = 10 \text{ V}$	$V_{GS(th) [V]}$	$I_D [A]$	typ. $Q_g [nC]$	Type
D-PAK	3.8	1.2...2.0	50.0	31.0	IPD04N03LA
	5.1	1.2...2.0	50.0	19.0	IPD05N03LA
	5.7	1.2...2.0	50.0	17.0	IPD06N03LA
	8.6	1.2...2.0	50.0	10.0	IPD09N03LA
	10.4	1.2...2.0	30.0	8.2	IPD10N03LA
	12.8	1.2...2.0	30.0	6.0	IPD13N03LA
Reverse D-PAK	4.1	1.2...2.0	50.0	31.0	IPF04N03LA
	5.4	1.2...2.0	50.0	19.0	IPF06N03LA
	8.9	1.2...2.0	50.0	10.0	IPF09N03LA
	10.6	1.2...2.0	30.0	8.2	IPF10N03LA
	13.3	1.2...2.0	30.0	6.0	IPF13N03LA
I-PAK	4.0	1.2...2.0	50.0	31.0	IPU04N03LA
	5.3	1.2...2.0	50.0	19.0	IPU05N03LA
	5.9	1.2...2.0	50.0	17.0	IPU06N03LA
	8.8	1.2...2.0	50.0	10.0	IPU09N03LA
	10.6	1.2...2.0	30.0	8.2	IPU10N03LA
	13.0	1.2...2.0	30.0	6.0	IPU13N03LA
D ² -PAK	2.7	1.2...2.0	80.0	43.0	IPB03N03LA
	3.9	1.2...2.0	80.0	24.0	IPB04N03LA
	4.6	1.2...2.0	80.0	19.0	IPB05N03LA
	5.9	1.2...2.0	50.0	17.0	IPB06N03LA
	8.9	1.2...2.0	50.0	10.0	IPB09N03LA
	11.2	1.2...2.0	30.0	8.2	IPB11N03LA
	13.6	1.2...2.0	30.0	6.0	IPB14N03LA
TO-220 (3-leg) I-PAK (TO-262)	3.0	1.2...2.0	80.0	43.0	IPP/I03N03LA
	4.2	1.2...2.0	80.0	24.0	IPP/I04N03LA
	4.9	1.2...2.0	80.0	19.0	IPP/I05N03LA
	6.2	1.2...2.0	50.0	17.0	IPP/I06N03LA
	9.2	1.2...2.0	50.0	10.0	IPP/I09N03LA
	11.5	1.2...2.0	30.0	8.2	IPP/I11N03LA
	13.9	1.2...2.0	30.0	6.0	IPP/I14N03LA



N-Channel 30 V (OptiMOS[®])

Package	$R_{DS(on) \text{ max.}}$ [m Ω] @ $V_{GS} = 10 \text{ V}$	$V_{GS(th)}$ [V]	I_D [A]	typ. Q_g [nC]	Type
SO-8	7.8	1.2...2.0	13.0	27.0	BSO4420
	10.0	1.2...2.0	12.7	21.0	BSO4822
	13.0	1.2...2.0	11.1	17.0	BSO4410
	20.0	1.2...2.0	8.0	13.5	BSO4804 (dual)

N-Channel 30 V (OptiMOS[®]2)

Package	$R_{DS(on) \text{ max.}}$ [m Ω] @ $V_{GS} = 10 \text{ V}$	$V_{GS(th)}$ [V]	I_D [A]	typ. Q_g [nC]	Type
SuperSO8	2.2	1.2...2.0	50.0	43.0	BSC022No3S
	3.2	1.2...2.0	50.0	29.0	BSC032No3S
	4.2	1.2...2.0	50.0	21.0	BSC042No3S
	5.2	1.2...2.0	50.0	16.0	BSC052No3S
	5.5	1.2...2.0	50.0	15.0	BSC059No3S
SO-8	5.2	1.2...2.0	17.0	32.0	BSO052No3S
	6.4	1.2...2.0	16.0	21.0	BSO064No3S
	6.8	1.2...2.0	15.0	19.0	BSO072No3S
	9.1	1.2...2.0	13.0	13.0	BSO094No3S
	9.7	1.2...2.0	13.0	12.0	BSO104No3S
	11.9	1.2...2.0	11.0	10.0	BSO119No3S
	15.0	1.2...2.0	9.1	11.0	BSO150No3 (dual)
	20.0	1.2...2.0	8.8	4.9	BSO200No3S
	30.0	1.2...2.0	7.2	3.5	BSO300No3S
	35.0	1.2...2.0	6.0	2.8	BSO350No3 (dual)

Power Series 30 V (OptiMOS®)

Package	$R_{DS(on) \text{ max.}}$ [mΩ] @ $V_{GS} = 10 \text{ V}$	$V_{GS(th)}$ [V]	I_D [A]	typ. Q_g [nC]	Type
D-PAK (5-leg) D-PAK	4.2	1.2...2.0	100.0	67.5	SPD100N03S2L-04
	6.7	1.2...2.0	30.0	51.0	SPD30N03S2L-07
	10.0	1.2...2.0	30.0	31.4	SPD30N03S2L-10
	20.0	1.2...2.0	30.0	14.3	SPD30N03S2L-20
	6.4	1.2...2.0	50.0	52.0	SPD50N03S2L-06
	7.3	2.1...4.0	50.0	35.0	SPD50N03S2-07
I-PAK	8.2	2.1...4.0	30.0	35.0	SPU30N03S2-08
	9.7	1.2...2.0	30.0	31.4	SPU30N03S2L-10
D ² -PAK	2.7	1.2...2.0	100.0	166.0	SPB100N03S2L-03
	3.0	2.1...4.0	100.0	113.0	SPB100N03S2-03
	2.8	1.2...2.0	80.0	166.0	SPB80N03S2-03
	3.1	2.1...4.0	80.0	110.0	SPB80N03S2-03
	3.9	1.2...2.0	80.0	79.0	SPB80N03S2L-04
	4.9	1.2...2.0	80.0	67.5	SPB80N03S2L-05
	5.9	1.2...2.0	80.0	51.0	SPB80N03S2L-06
	8.1	1.2...2.0	73.0	34.7	SPB73N03S2L-08
	12.6	1.2...2.0	42.0	22.9	SPB42N03S2L-13
TO-220 (3-leg) I ² -PAK (TO-262)	3.0	1.2...2.0	100.0	166.0	SPP/I100N03S2L-03
	3.3	2.1...4.0	100.0	113.0	SPP/I100N03S2-03
	3.1	1.2...2.0	80.0	166.0	SPP/I80N03S2L-03
	3.4	2.1...4.0	80.0	110.0	SPP/I80N03S2-03
	4.2	1.2...2.0	80.0	79.0	SPP/I80N03S2L-04
	5.2	1.2...2.0	80.0	67.5	SPP/I80N03S2L-05
	6.2	1.2...2.0	80.0	51.0	SPP/I80N03S2L-06
	8.4	1.2...2.0	73.0	34.7	SPP/I73N03S2L-08
	12.9	1.2...2.0	42.0	22.9	SPP/I42N03S2L-13

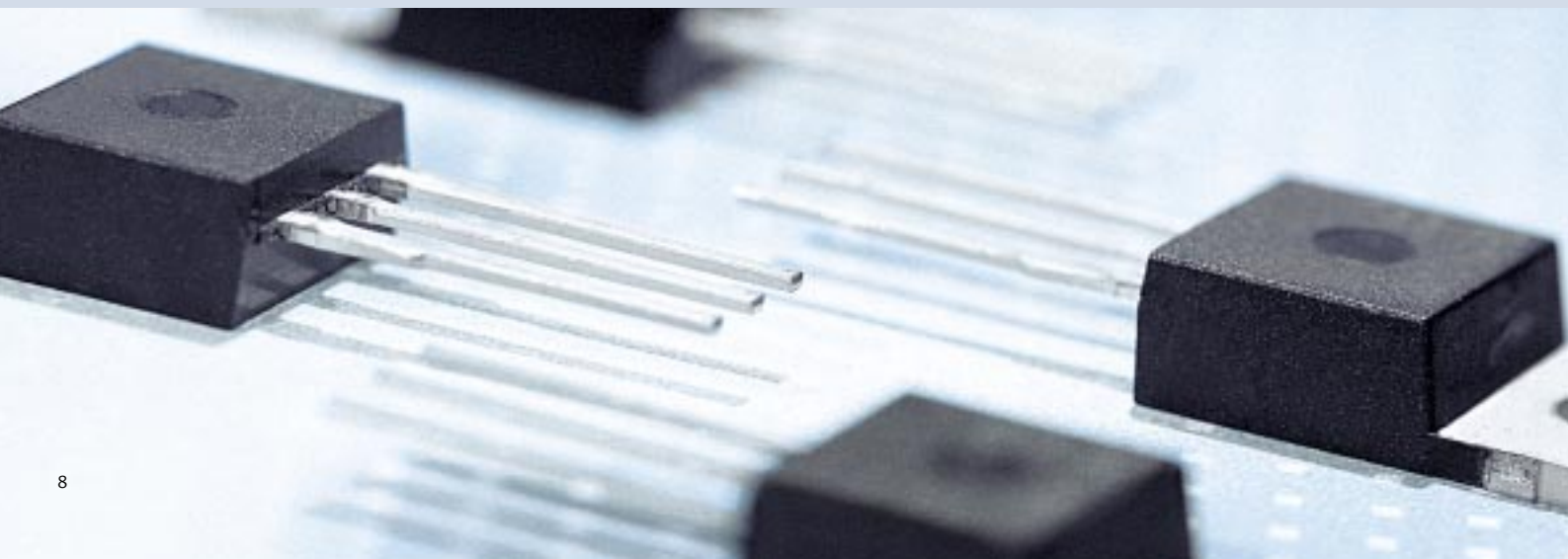

N-Channel 40 V (OptiMOS[®])

Package	$R_{DS(on)}$ max. [m Ω] @ $V_{GS} = 10$ V	$V_{GS(th)}$ [V]	I_D [A]	typ. Q_g [nC] @ $V_{GS} = 10$ V	Type
TO-220 (3-leg) D ² -PAK	3.6	2.1...4.0	100.0	129.0	SPP/B100No4S2-04
	3.3	1.2...2.0	100.0	170.0	SPP/B100No4S2L-03
	3.7	2.1...4.0	80.0	135.0	SPP/B80No4S2-04
	3.4	1.2...2.0	80.0	160.0	SPP/B80No4S2L-03
TO-220 (3-leg) TO-262/TO-263	4.0	2.1...4.0	80.0	148.0	SPP/B/180No4S2-H4
TO-263 (7-leg)	2.9	2.1...4.0	160.0	170.0	SPB160No4S2-03
	2.7	1.2...2.0	160.0	230.0	SPB160No4S2L-03

N-Channel Enhancement 50 V

Package	$R_{DS(on)}$ [m Ω]	$V_{GS(th)}$ [V]	I_D [A]	Type
SOT-223	300	0.8...2.0	1.8	BSP295

N-Channel 55 V (OptiMOS[®])

Package	$R_{DS(on)}$ max. [m Ω] @ $V_{GS} = 10$ V	$V_{GS(th)}$ [V]	I_D [A]	typ. Q_g [nC] @ $V_{GS} = 10$ V	Type
TO-220 (3-leg) D ² -PAK	4.7	1.2...2.0	100.0	165.0	SPP/B100No6S2L-05
	5.0	2.1...4.0	100.0	127.0	SPP/B100No6S2-05
	4.8	1.2...2.0	80.0	165.0	SPP/B80No6S2L-05
	5.1	2.1...4.0	80.0	120.0	SPP/B80No6S2-05
	6.3	1.2...2.0	80.0	115.0	SPP/B80No6S2L-06
	6.6	2.1...4.0	80.0	96.0	SPP/B80No6S2-07
	7.0	1.2...2.0	80.0	97.0	SPP/B80No6S2L-07
	8.0	2.1...4.0	80.0	72.0	SPP/B80No6S2-08
	8.5	1.2...2.0	80.0	78.0	SPP/B80No6S2L-09
	9.1	2.1...4.0	80.0	62.0	SPP/B80No6S2-09
	11.0	1.2...2.0	80.0	62.0	SPP/B80No6S2L-11
12.0	2.1...4.0	77.0	49.0	SPP/B77No6S2-12	
TO-220 TO-263 (3-leg)	5.0	1.2...2.0	80.0	190.0	SPP/B80No6S2L-H5
	5.5	2.1...4.0	80.0	155.0	SPP/B80No6S2-H5
D-PAK	12.7	1.2...2.0	50.0	55.0	SPD50No6S2L-13
	14.4	2.1...4.0	50.0	41.0	SPD50No6S2-14
	13.0	1.2...2.0	30.0	52.0	SPD30No6S2L-13
	14.7	2.1...4.0	30.0	40.0	SPD30No6S2-15
	23.0	1.2...2.0	30.0	33.0	SPD30No6S2L-23
	23.0	2.1...4.0	30.0	26.0	SPD30No6S2-23
	35.0	1.2...2.0	26.0	20.0	SPD26No6S2L-35
	40.0	2.1...4.0	25.0	16.0	SPD25No6S2-40
	64.0	1.2...2.0	15.0	12.0	SPD15No6S2L-64
80.0	2.1...4.0	14.0	9.0	SPD14No6S2-80	
SO-8	35.0	1.2...2.0	5.0	19.0	BSO604NS2 (dual)
SOT-223	33.0	1.2...2.0	5.2	33.0	BSP603S2L
	90.0	1.2...2.0	2.8	8.1	BSP615S2L
SOT-23	650.0	1.2...2.0	0.54	1.7	BSS670S2L

N-Channel Enhancement 60 V

Package	$R_{DS(on) \text{ max. [m}\Omega]$ @ $V_{GS} = 10 \text{ V}$	$V_{GS(th) [V]$	$I_D [A]$	typ. $Q_g [nC]$	Type
SO-8	150	1.2...2.0	2.6	14.0	B50615N (dual)
SOT-223	90	1.2...2.0	2.6	14.0	BSP318S
	120	2.1...4.0	2.9	9.7	BSP320S
SOT-23	3,500	0.6...1.4	0.23	1.12	BSS138N
	5,000	0.8...2.0	0.2	1.00	SN7002N
	5,000	1.0...2.5	0.2	1.15	BSS7728N
SOT-323	3,500	0.6...1.4	0.28	1.13	BSS138W
	5,000	0.8...2.0	0.2	1.0	SN7002W

N-Channel 75 V (OptiMOS[®])

Package	$R_{DS(on) \text{ max. [m}\Omega]$ @ $V_{GS} = 10 \text{ V}$	$V_{GS(th) [V]$	$I_D [A]$	typ. $Q_g [nC]$ @ $V_{GS} = 10 \text{ V}$	Type
D-PAK	21.5	2.1...4.0	30.0	43.0	SPD30No8S2-22
	20.5	1.2...2.0	30.0	33.0	SPD30No8S2L-21
	50.0	1.2...2.0	22.0	22.0	SPD22No8S2L-50
TO-220 (3-leg) D ² -PAK	7.1	2.1...4.0	100.0	153.0	SPP/B100No8S2-07
	6.8	1.2...2.0	100.0	185.0	SPP/B100No8S2L-07
	7.4	2.1...4.0	80.0	138.0	SPP/B80No8S2-07
	7.1	1.2...2.0	80.0	186.0	SPP/B80No8S2L-07
TO-262	7.3	2.1...4.0	80.0	138.0	SPI80No8S2-07R*

* with integrated gate resistor for easy paralleling of FETs

N-Channel Enhancement 100 V

Package	$R_{DS(on) \text{ max. [m}\Omega]$ @ $V_{GS} = 10 \text{ V}$	$V_{GS(th) [V]$	$I_D [A]$	typ. $Q_g [nC]$ @ $V_{GS} = 10 \text{ V}$	Type
TO-220 (3-leg) D ² -PAK TO-262	14	1.2...2.0	80.0	160.0	SPP/B/180N10L
	16	1.2...2.0	70.0	160.0	SPP/B/170N10L
	26	1.2...2.0	47.0	90.0	SPP/B/147N10L
	33	2.1...4.0	47.0	70.0	SPP/B/147N10
	44	2.1...4.0	35.0	49.0	SPP/B/135N10
	80	2.1...4.0	21.0	28.9	SPP/B/121N10
	154	1.2...2.0	10.3	17.7	SPP/B/110N10L
	170	2.1...4.0	10.3	14.6	SPP/B/110N10
D-PAK	44	2.1...4.0	35.0	49.0	SPD35N10
	170	2.1...4.0	10.5	14.6	SPD/U11N10
SOT-223	300	2.1...4.0	1.7	–	BSP373
	310	0.8...2.0	1.7	–	BSP372
	800	0.8...2.0	1.0	–	BSP296
	6,000	0.8...2.0	0.38	–	BSP123
SOT-23	6,000	0.8...2.0	0.17	–	BSS123
	6,000	1.6...2.6	0.17	–	BSS119
TO-218	35	2.1...4.0	50.0	210.0	BUZ344
	45	2.1...4.0	41.0	78.0	BUZ345
	60	2.1...4.0	32.0	62.0	BUZ349

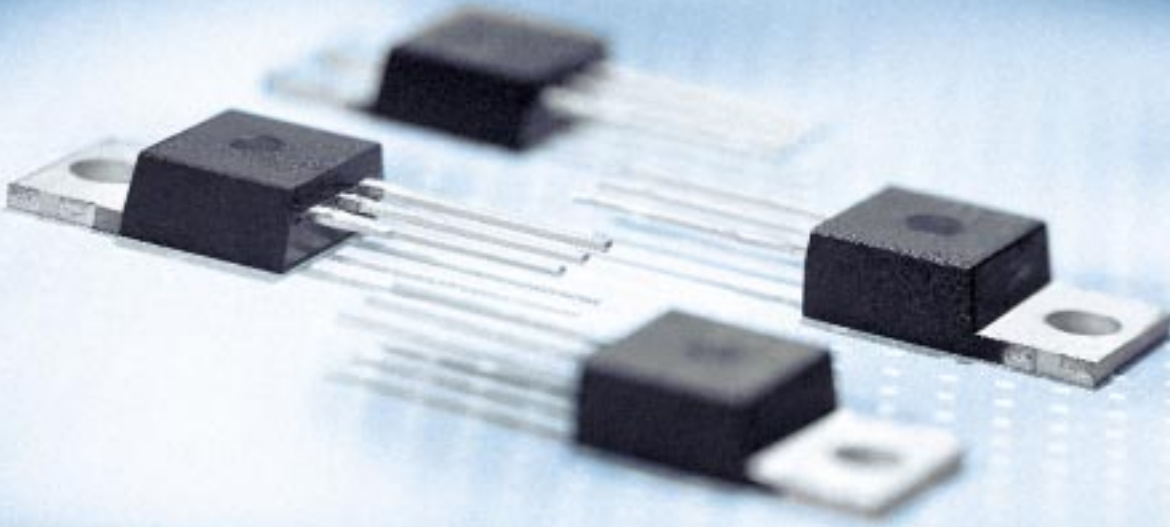

N-Channel Enhancement 200 V

Package	$R_{DS(on) \text{ max. } [\Omega]}$ @ $V_{GS} = 10 \text{ V}$	$V_{GS(th)} [V]$	$I_D [A]$	typ. $Q_g [nC]$ @ $V_{GS} = 10 \text{ V}$	Type
D-PAK I-PAK	0.4	2.1...4.0	7.0	21.0	SPD/U07N20
SOT-223	2.0	0.8...2.0	0.65	–	BSP297
TO-218	0.07	2.1...4.0	33.0	112.0	BUZ341
	0.12	2.1...4.0	22.0	64.0	BUZ350
TO-220 (3-leg) D ² -PAK	0.13	2.1...4.0	21.0	64.0	BUZ30A
	0.2	2.1...4.0	14.5	50.0	BUZ31
	0.2	1.2...2.0	13.5	90.0	BUZ31L
	0.4	2.1...4.0	9.5	24.0	BUZ32
	0.4	2.1...4.0	7.0	24.0	BUZ73
	0.4	1.2...2.0	7.0	58.0	BUZ73L
	0.6	2.1...4.0	5.5	24.0	BUZ73A
	0.6	1.2...2.0	5.5	58.0	BUZ73AL

N-Channel Enhancement 240 V

Package	$R_{DS(on) \text{ max. } [\Omega]}$ @ $V_{GS} = 10 \text{ V}$	$V_{GS(th)} [V]$	$I_D [A]$	Type
SOT-223	6	0.8...2.0	0.5	BSP89
	8	0.6...1.2	0.25	BSP88
SOT-89	6	0.8...2.0	0.29	BSS87
SOT-23	16	0.8...2.0	0.1	BSS131

P-Channel MOSFETs

P-Channel -20 V (OptiMOS[®])

Package	$R_{DS(on) \text{ max.}}$ [m Ω] @ $V_{GS} = 4.5 \text{ V}$	$R_{DS(on) \text{ max.}}$ [m Ω] @ $V_{GS} = 2.5 \text{ V}$	$V_{GS(th)}$ [V]	I_D [A]	typ. Q_g [nC]	Type
SO-8	8	12.9	-1.2...-0.6	14.9	85.5	BSO201SP
	21	34.0	-1.2...-0.6	9.0	33.6	BSO203SP
	21	35.0	-1.2...-0.6	8.2	32.4	BSO203P (dual)
	30	42.0	-1.2...-0.6	7.0	23.9	BSO204P (dual)
	45	70.0	-1.2...-0.6	5.7	15.6	BSO207P (dual)
	67	110.0	-1.2...-0.6	4.7	15.9	BSO211P (dual)
SOT-323	550	900.0	-1.2...-0.6	0.58	0.92	BSS209PW
	1,200	2,100.0	-1.2...-0.6	0.39	0.5	BSS223PW
SOT-363	175	285.0	-1.2...-0.6	1.5	3.8	BSV236SP
	1,200	2,100.0	-1.2...-0.6	0.35	0.5	BSD223P (dual)
TSOP-6	41	65.0	-1.2...-0.6	6.0	13.3	BSL207SP
	67	110.0	-1.2...-0.6	4.7	8.3	BSL211SP
SC-75	1,200	2,100.0	-1.2...-2.1	-0.39	-0.5	BSA223SP

P-Channel -30 V (OptiMOS[®])

Package	$R_{DS(on) \text{ max.}}$ [m Ω] @ $V_{GS} = 10 \text{ V}$	$R_{DS(on) \text{ max.}}$ [m Ω] @ $V_{GS} = 4.5 \text{ V}$	$V_{GS(th)}$ [V]	I_D [A]	typ. Q_g [nC]	Type
D-PAK (5-leg)	7	12.5	-2.0...-1.0	50.0	119.0	SPD50Po3L
SO-8	8	–	-2.2...-1.0	14.9	102.0	BSO080Po3S
	13	–	-2.2...-1.0	11.3	61.0	BSO130Po3S
	20	–	-2.2...-1.0	9.1	40.0	BSO200Po3S
	21	32.0	-2.0...-1.0	8.2	48.3	BSO303P (dual)
TSOP-6	43	74.0	-2.0...-1.0	5.5	23.4	BSL307SP

P-Channel -60 V

Package	$R_{DS(on) \text{ max.}}$ [Ω] @ $V_{GS} = 10 \text{ V}$	$R_{DS(on) \text{ max.}}$ [Ω] @ $V_{GS} = 4.5 \text{ V}$	$V_{GS(th)}$ [V]	I_D [A]	typ. Q_g [nC]	Type
D-PAK I-PAK	0.075	–	-4.0...-2.1	-30.0	32.0	SPD/U30Po6P
	0.13	–	-4.0...-2.1	-18.6	22.0	SPD/U18Po6P
	0.25	0.4	-2.0...-1.0	-9.7	14.0	SPD/U09Po6PL
	0.3	–	-4.0...-2.1	-8.8	10.0	SPD/U08Po6P
SO-8	0.13	–	-4.0...-2.1	-3.44	20.0	BSO613SPV
SOT-23	2.0	3.0	-2.0...-1.0	-0.33	2.38	BSS83P
	8.0	12.0	-2.0...-1.0	-0.17	1.0	BSS84P

P-Channel -60 V

Package	$R_{DS(on) \text{ max.}} [\Omega]$ @ $V_{GS} = 10 \text{ V}$	$R_{DS(on) \text{ max.}} [\Omega]$ @ $V_{GS} = 4.5 \text{ V}$	$V_{GS(th)} [V]$	$I_D [A]$	typ. $Q_g [nC]$	Type
SOT-223	0.13	–	-4.0...-2.1	-2.9	22.0	BSP613P
	0.3	–	-4.0...-2.1	-1.9	12.5	BSP170P
	0.3	0.45	-2.0...-1.0	-1.9	13.3	BSP171P
	0.8	1.4	-2.0...-1.0	-1.17	5.2	BSP315P
SOT-323	8.0	12.0	-2.0...-1.0	-0.15	1.0	BSS84PW*
TO-220 (3-leg) D ² -PAK	0.023	–	-4.0...-2.1	-80.0	115.0	SPP/B80Po6P
	0.13	–	-4.0...-2.1	-18.6	22.0	SPP/B18Po6P
	0.3	–	-4.0...-2.1	-8.8	10.0	SPP/Bo8Po6P

* $R_{DS(on) \text{ max.}} = 25 \Omega$, @ $V_{GS} = 2.7 \text{ V}$

P-Channel -100V

Package	$R_{DS(on) \text{ max.}} [m\Omega]$ @ $V_{GS} = 10 \text{ V}$	$R_{DS(on) \text{ max.}} [m\Omega]$ @ $V_{GS} = 4,5 \text{ V}$	$V_{GS(th)} [V]$	$I_D [A]$	typ. $Q_g [nC]$	Type
SOT-223	1.8	2.3	-2.0...-1.0	-0.68	5.1	BSP316P
TO-220	0.24	–	-4.0...-2.1	15.0	33.4	SPP15P10P

P-Channel -250V

Package	$R_{DS(on) \text{ max.}} [m\Omega]$ @ $V_{GS} = 10 \text{ V}$	$R_{DS(on) \text{ max.}} [m\Omega]$ @ $V_{GS} = 4,5 \text{ V}$	$V_{GS(th)} [V]$	$I_D [A]$	typ. $Q_g [nC]$	Type
SOT-223	5	4	-2.0...-1.0	0.43	11.6	BSP317P
	12	15	-2.0...-1.0	0.26	4.3	BSP92P
SOT-89	12	15	-2.0...-1.0	0.19	4.9	BSS192P

Complementary P/N-Enhancement

Package	$V_{DS} [V]$	$R_{DS(on)} [m\Omega]$	$V_{GS(th)} [V]$	$I_D [A]$	typ. $Q_g [nC]$		Type
					P	N	
SO-8	60	110	1.2...2.0	-3.1	13.5	15.0	BSO615C
	-60	300	-2.0...-1.0	-2.0			
	60	120	2.1...4.0	3.0	10.5	10.3	BSO612CV
	-60	300	-4.0...-2.1	-2.0			













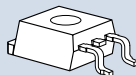
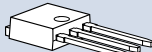

Alphanumeric Listing

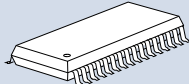
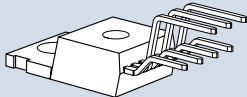
Product name	Product description	Voltage class	Page	Product name	Product description	Voltage class	Page
BSA223SP	P-Channel MOSFET	-20 V	12	BSO094No3S	N-Channel MOSFET	30 V	7
BSCo22No3S	N-Channel MOSFET	30 V	7	BSO104No3S	N-Channel MOSFET	30 V	7
BSCo32No3S	N-Channel MOSFET	30 V	7	BSO119No3S	N-Channel MOSFET	30 V	7
BSCo42No3S	N-Channel MOSFET	30 V	7	BSO130Po3S	P-Channel MOSFET	-30 V	12
BSCo52No3S	N-Channel MOSFET	30 V	7	BSO150No3S (dual)	N-Channel MOSFET	30 V	7
BSCo59No3S	N-Channel MOSFET	30 V	7	BSO200No3S	N-Channel MOSFET	30 V	7
BSD223P (dual)	P-Channel MOSFET	-20 V	12	BSO200Po3S	P-Channel MOSFET	-30 V	12
BSL207SP	P-Channel MOSFET	-20 V	12	BSO201SP	P-Channel MOSFET	-20 V	12
BSL211SP	P-Channel MOSFET	-20 V	12	BSO203P (dual)	P-Channel MOSFET	-20 V	12
BSL307SP	P-Channel MOSFET	-30 V	12	BSO203SP	P-Channel MOSFET	-20 V	12
BSO052No3S	N-Channel MOSFET	30 V	7	BSO204P (dual)	P-Channel MOSFET	-20 V	12
BSO064No3S	N-Channel MOSFET	30 V	7	BSO207P (dual)	P-Channel MOSFET	-20 V	12
BSO072No3S	N-Channel MOSFET	30 V	7	BSO211P (dual)	P-Channel MOSFET	-20 V	12
BSO080Po3S	P-Channel MOSFET	-30 V	12	BSO300No3S	N-Channel MOSFET	30 V	7

Alphanumeric Listing

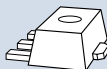
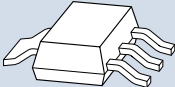
Product name	Product description	Voltage class	Page	Product name	Product description	Voltage class	Page
BSO303P (dual)	P-Channel MOSFET	-30 V	12	IPU06No3LA	OptiMOS2 Transistor	25 V	6
BSO350No3S (dual)	N-Channel MOSFET	30 V	7	IPU09No3LA	OptiMOS2 Transistor	25 V	6
BSO4410	N-Channel MOSFET	30 V	6	IPU10No3LA	N-Channel MOSFET	25 V	6
BSO4420	N-Channel MOSFET	30 V	6	IPU13No3LA	OptiMOS2 Transistor	25 V	6
BSO4804 (dual)	N-Channel MOSFET	30 V	6	SN7002N	N-Channel Enhancement	60 V	10
BSO4822	N-Channel MOSFET	30 V	6	SN7002W	N-Channel Enhancement	60 V	10
BSO604NS2 (dual)	N-Channel MOSFET	55 V	9	SPB160No4S2-03	N-Channel MOSFET	40 V	9
BSO613SPV	P-Channel MOSFET	-60 V	12	SPB160No4S2L-03	N-Channel MOSFET	40 V	9
BSO612CV	Complementary P/N Enhancemet MOSFET	60 V	13	SPB/P80No6S2-H5	N-Channel MOSFET	55 V	9
BSO612CV	Complementary P/N Enhancemet MOSFET	-60 V	13	SPB/P80No6S2L-H5	N-Channel MOSFET	55 V	9
BSO615C	Complementary P/N Enhancemet MOSFET	60 V	13	SPB/P180No4S2-H4	N-Channel MOSFET	40 V	9
BSO615C	Complementary P/N Enhancemet MOSFET	-60 V	13	SPD14No6S2-80	N-Channel MOSFET	55 V	9
BSO615N (dual)	N-Channel Enhancement	60 V	10	SPD15No6S2L-64	N-Channel MOSFET	55 V	9
BSP123	N-Channel Enhancement MOSFET	100 V	10	SPD22No8S2L-50	N-Channel MOSFET	75 V	10
BSP170P	P-Channel MOSFET	-60 V	13	SPD25No6S2-40	N-Channel MOSFET	55 V	9
BSP171P	P-Channel MOSFET	-60 V	13	SPD26No6S2L-35	N-Channel MOSFET	55 V	9
BSP295	N-Channel MOSFET	50 V	9	SPD30No3S2L-07	Power Series	30 V	8
BSP296	N-Channel Enhancement MOSFET	100 V	10	SPD30No3S2L-10	Power Series	30 V	8
BSP297	N-Channel Enhancement MOSFET	200 V	11	SPD30No3S2L-20	Power Series	30 V	8
BSP315P	P-Channel MOSFET	-60 V	13	SPD30No6S2-15	N-Channel MOSFET	55 V	9
BSP316P	P-Channel MOSFET	-100 V	13	SPD30No6S2-23	N-Channel MOSFET	55 V	9
BSP317P	P-Channel MOSFET	-240 V	13	SPD30No6S2L-13	N-Channel MOSFET	55 V	9
BSP318S	N-Channel Enhancement	60 V	10	SPD30No6S2L-23	N-Channel MOSFET	55 V	9
BSP320S	N-Channel Enhancement	60 V	10	SPD30No8S2-22	N-Channel MOSFET	75 V	10
BSP372	N-Channel Enhancement MOSFET	100 V	10	SPD30No8S2L-21	N-Channel MOSFET	75 V	10
BSP373	N-Channel Enhancement MOSFET	100 V	10	SPD35N10	N-Channel Enhancement MOSFET	100 V	10
BSP603S2L	N-Channel MOSFET	55 V	9	SPD50No3S2-07	Power Series	30 V	8
BSP613P	P-Channel MOSFET	-60 V	13	SPD50No3S2L-06	Power Series	30 V	8
BSP615S2L	N-Channel MOSFET	55 V	9	SPD50No6S2-14	N-Channel MOSFET	55 V	9
BSP88	N-Channel Enhancement	240 V	11	SPD50No6S2L-13	N-Channel MOSFET	55 V	9
BSP89	N-Channel Enhancement	240 V	11	SPD50P03L	P-Channel MOSFET	-30 V	12
BSP92P	P-Channel MOSFET	-240 V	13	SPD100No3S2L-04	Power Series	30 V	8
BSS119	N-Channel Enhancement MOSFET	100 V	10	SPD/U07N20	N-Channel Enhancement MOSFET	200 V	11
BSS123	N-Channel Enhancement MOSFET	100 V	10	SPD/U08P06P	P-Channel MOSFET	-60 V	12
BSS131	N-Channel Enhancement	240 V	11	SPD/U09P06PL	P-Channel MOSFET	-60 V	12
BSS138N	N-Channel Enhancement	60 V	10	SPD/U11N10	N-Channel Enhancement MOSFET	100 V	10
BSS138W	N-Channel Enhancement	60 V	10	SPD/U18P06P	P-Channel MOSFET	-60 V	12
BSS192P	P-Channel MOSFET	-240 V	13	SPD/U30P06P	P-Channel MOSFET	-60 V	12
BSS209PW	P-Channel MOSFET	-20 V	12	SPI80No8S2-07R	N-Channel MOSFET	75 V	10
BSS223PW	P-Channel MOSFET	-20 V	12	SPP15P10P	P-Channel MOSFET	-100 V	13
BSS670S2L	N-Channel MOSFET	55 V	9	SPP/B08P06P	P-Channel MOSFET	-60 V	13
BSS7728N	N-Channel Enhancement	60 V	10	SPP/B18P06P	P-Channel MOSFET	-60 V	13
BSS83P	P-Channel MOSFET	-60 V	12	SPP/B77No6S2-12	N-Channel MOSFET	55 V	9
BSS84P	P-Channel MOSFET	-60 V	12	SPP/B80No4S2-04	N-Channel MOSFET	40 V	9
BSS84PW	P-Channel MOSFET	-60 V	13	SPP/B80No4S2L-03	N-Channel MOSFET	40 V	9
BSS87	N-Channel Enhancement	240 V	11	SPP/B80No6S2-05	N-Channel MOSFET	55 V	9
BSV236SP	P-Channel MOSFET	-20 V	12	SPP/B80No6S2L-05	N-Channel MOSFET	55 V	9
BUZ30A	N-Channel Enhancement MOSFET	200 V	11	SPP/B80No6S2L-06	N-Channel MOSFET	55 V	9
BUZ31	N-Channel Enhancement MOSFET	200 V	11	SPP/B80No6S2-07	N-Channel MOSFET	55 V	9
BUZ31L	N-Channel Enhancement MOSFET	200 V	11	SPP/B80No6S2-08	N-Channel MOSFET	55 V	9
BUZ32	N-Channel Enhancement MOSFET	200 V	11	SPP/B80No6S2-09	N-Channel MOSFET	55 V	9
BUZ341	N-Channel Enhancement MOSFET	200 V	11	SPP/B80No6S2L-09	N-Channel MOSFET	55 V	9
BUZ344	N-Channel Enhancement MOSFET	100 V	10	SPP/B80No6S2L-11	N-Channel MOSFET	55 V	9
BUZ345	N-Channel Enhancement MOSFET	100 V	10	SPP/B80No8S2-07	N-Channel MOSFET	75 V	10
BUZ349	N-Channel Enhancement MOSFET	100 V	10	SPP/B80No8S2L-07	N-Channel MOSFET	75 V	10
BUZ350	N-Channel Enhancement MOSFET	200 V	11	SPP/B80P06P	P-Channel MOSFET	-60 V	13
BUZ73	N-Channel Enhancement MOSFET	200 V	11	SPP/B100No4S2-04	N-Channel MOSFET	40 V	9
BUZ73A	N-Channel Enhancement MOSFET	200 V	11	SPP/B100No8S2-03	N-Channel MOSFET	40 V	9
BUZ73AL	N-Channel Enhancement MOSFET	200 V	11	SPP/B100No6S2-05	N-Channel MOSFET	55 V	9
BUZ73L	N-Channel Enhancement MOSFET	200 V	11	SPP/B100No6S2L-05	N-Channel MOSFET	55 V	9
IPB03No3LA	OptiMOS2 Transistor	25 V	6	SPP/B100No8S2-07	N-Channel MOSFET	75 V	10
IPB04No3LA	OptiMOS2 Transistor	25 V	6	SPP/B100No8S2L-07	N-Channel MOSFET	75 V	10
IPB05No3LA	OptiMOS2 Transistor	25 V	6	SPP/B/110N10	N-Channel Enhancement MOSFET	100 V	10
IPB06No3LA	OptiMOS2 Transistor	25 V	6	SPP/B/110N10L	N-Channel Enhancement MOSFET	100 V	10
IPB09No3LA	OptiMOS2 Transistor	25 V	6	SPP/B/121N10	N-Channel Enhancement MOSFET	100 V	10
IPB11No3LA	N-Channel MOSFET	25 V	6	SPP/B/135N10	N-Channel Enhancement MOSFET	100 V	10
IPB14No3LA	OptiMOS2 Transistor	25 V	6	SPP/B/142No3S2L-13	Power Series	30 V	9
IPD04No3LA	OptiMOS2 Transistor	25 V	6	SPP/B/147N10	N-Channel Enhancement MOSFET	100 V	10
IPD05No3LA	OptiMOS2 Transistor	25 V	6	SPP/B/147N10L	N-Channel Enhancement MOSFET	100 V	10
IPD06No3LA	OptiMOS2 Transistor	25 V	6	SPP/B/170N10L	N-Channel Enhancement MOSFET	100 V	10
IPD09No3LA	OptiMOS2 Transistor	25 V	6	SPP/B/173No3S2L-08	Power Series	30 V	9
IPD10No3LA	N-Channel MOSFET	25 V	6	SPP/B/180N10L	N-Channel Enhancement MOSFET	100 V	10
IPD13No3LA	OptiMOS2 Transistor	25 V	6	SPP/B/180No3S2-03	Power Series	30 V	8
IPF04No3LA	OptiMOS2 Transistor	25 V	6	SPP/B/180No3S2L-03	Power Series	30 V	8
IPF06No3LA	OptiMOS2 Transistor	25 V	6	SPP/B/180No3S2L-04	Power Series	30 V	8
IPF09No3LA	OptiMOS2 Transistor	25 V	6	SPP/B/180No3S2L-05	Power Series	30 V	8
IPF10No3LA	N-Channel MOSFET	25 V	6	SPP/B/180No3S2L-06	Power Series	30 V	8
IPF13No3LA	OptiMOS2 Transistor	25 V	6	SPP/B/100No3S2-03	Power Series	30 V	8
IPP14No3LA	OptiMOS2 Transistor	25 V	6	SPP/B/100No3S2L-03	Power Series	30 V	8
IPP103No3LA	OptiMOS2 Transistor	25 V	6	SPU30No3S2-08	Power Series	30 V	8
IPP104No3LA	OptiMOS2 Transistor	25 V	6	SPU30No3S2L-10	Power Series	30 V	8
IPP105No3LA	OptiMOS2 Transistor	25 V	6	SPP/B100No6S2L-05	N-Channel MOSFET	55 V	9
IPP106No3LA	OptiMOS2 Transistor	25 V	6	TDA21102	Dual Gate Driver	IC	4
IPP109No3LA	OptiMOS2 Transistor	25 V	6	TDA21106	Single Gate Driver	IC	4
IPP111No3LA	N-Channel MOSFET	25 V	6	TDA21201	Integrated Switch	IC	4
IPP114No3LA	OptiMOS2 Transistor	25 V	6	TDA21302	PWM Control IC	IC	4
IPU04No3LA	OptiMOS2 Transistor	25 V	6				
IPU05No3LA	N-Channel MOSFET	25 V	6				

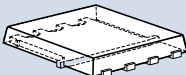
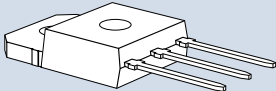
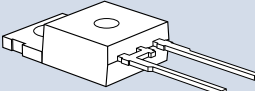
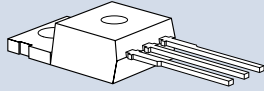
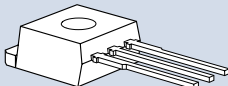
Packages

<p>D-PAK (P-TO252-3-1)</p> 	<p>Reverse D-PAK (P-TO252-3-23)</p> 	<p>D-PAK (5-leg) (P-TO252-5-1)</p> 	<p>D²-PAK (P-TO263-3-2)</p> 
<p>I-PAK (P-TO251-3-1)</p> 	<p>P-DSO-8</p> 	<p>P-DSO-14</p> 	<p>P-DSO-32</p> 
<p>P-TO220-7</p> 	<p>SC-75</p> 	<p>SO-8 (P-DSO-8-1)</p> 	<p>SOT-23 (P-SOT23-3)</p> 
<p>SOT-89 (P-SOT89-4)</p> 	<p>SOT-223 (P-SOT223-4)</p> 	<p>SOT-323 (P-SOT323-3)</p> 	<p>SOT-363 (P-SOT363-6)</p> 
<p>Super SO-8</p> 	<p>TO-218 (P-TO218-3-1)</p> 	<p>TO-220 (2-leg) (P-TO220-2-2)</p> 	<p>TO-220 (3-leg) (P-TO220-3-1)</p> 
<p>I²-PAK (TO-262)</p> 	<p>TSOP-6 (P-TSOP-6-1)</p> 		

More detailed INFORMATION on Power Management and Supply is available:

On our Website:

www.infineon.com/dc2dc

- Data sheets
- Application notes
- Technical articles
- Simulation models
- Literature order codes

On our CD ROM:

"Power Semiconductors High Voltage", Ordering No.: B152-H8020-X-X-7400*

In our data books:

"Power Semiconductors Low Voltage", Ordering No.: B152-H7446-X-X-7400*

Please send your order to

* Siemens AG
SPLS LP MS - Infineon Book Shop
Postfach 23 52
90713 Fürth-Bislohe, Germany
Tel. (09 11) 6 54-42 20/42 62
Fax (09 11) 6 54-42 71
www.click4business-supplies.de

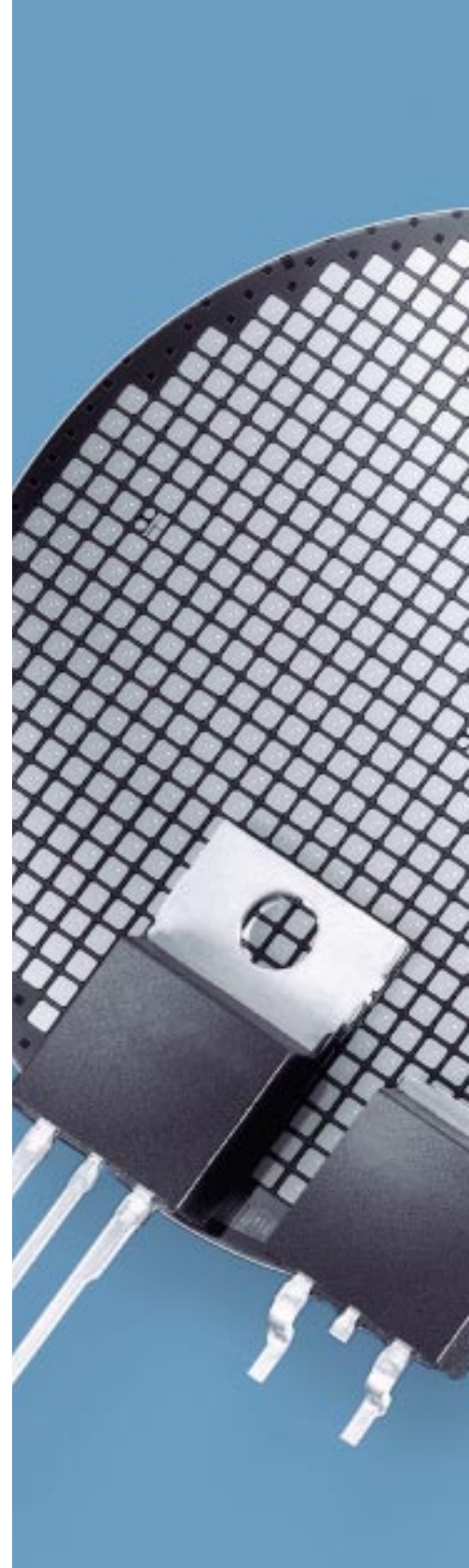

Edition March 2004

Published by
Infineon Technologies AG,
St.-Martin-Straße 53,
D-81669 München

© Infineon Technologies AG 2004.
All Rights Reserved.

Attention please!

The information herein is given to describe certain components and shall not be considered as a guarantee of characteristics. Terms of delivery and rights to technical change reserved. We hereby disclaim any and all warranties, including but not limited to warranties of non-infringement, regarding circuits, descriptions and charts stated herein. Infineon Technologies is an approved CECC manufacturer.

Information

For further information on technology, delivery terms and conditions and prices please contact your nearest Infineon Technologies Office in Germany or our Infineon Technologies Representatives worldwide (www.infineon.com).

Warnings

Due to technical requirements components may contain dangerous substances. For information on the types in question please contact your nearest Infineon Technologies Office.

Infineon Technologies Components may only be used in life support devices or systems with the express written approval of Infineon Technologies, if a failure of such components can reasonably be expected to cause the failure of that life support device or system, or to affect the safety or effectiveness of that device or system. Life support devices or systems are intended to be implanted in the human body, or to support and/or maintain and sustain and/or protect human life. If they fail, it is reasonable to assume that the health of the user or other persons may be endangered.

INFINEON TECHNOLOGIES SALES OFFICES WORLDWIDE*

Australia (AUS)

Siemens Ltd.
885 Mountain Highway
Bayswater, Victoria 3153
☎ (+61) 3-97 21 21 11
Fax (+61) 3-97 21 72 75

Austria (A)

Infineon Technologies Villach AG
Sales Office
Austria AG
Operngasse 20b/31
1040 Wien
☎ (+43) 1-5 87-70 70 0
Fax (+43) 1-5 87-70 70 20

Belgium/ Netherlands (B) (NL) (L)

Infineon Technologies Holding B.V.
Sales Division
Westblaak 32
3012 KM Rotterdam
☎ (+31) 10-2 17 68 00
Fax (+31) 10-2 17 68 19

Brazil (BR)

Infineon Technologies
South America Ltda.
Av. Mutinga, 3800 - prédio 3
05110-901 São Paulo-SP
☎ (+55) 11-39 08-25 64
Fax (+55) 11-39 08-27 28

Canada (CDN)

Infineon Technologies Corporation
340 March Road, Suite 301
Kanada, Ontario K2K 2E2
☎ (+1) 6 13-5 91-38 35
Fax (+1) 6 13-5 91-89 54

China (CN)

Infineon Technologies
International Trade (Shanghai) Co., Ltd.
Beijing Representative Office
12th Floor, Quantum Plaza
No.27 Zhichun Road
Haidian District,
Beijing 100083,
People's Republic of China
☎ (+86) 10 82 35 61 18
Fax (+86) 10 82 35 54 74

Infineon Technologies
Hong Kong Ltd.
Hong Kong Office
302 Level 3 Festival Walk
80 Tat Chee Avenue
Kowloon Tong

Hong Kong
☎ (+8 52) 28 32 05 00
Fax (+8 52) 28 27 97 62

Infineon Technologies
International Trade (Shanghai) Co., Ltd.
No. 8, Lane 647, Songtao Road
Zhangjiang Hi-Tech Park
Pudong, Shanghai, China
☎ (+86) 21-38 95 37 08
Fax (+86) 21-50 80 62 04

Infineon Technologies
International Trade (Shanghai) Co., Ltd.
Shenzhen Office
Room 1501-05, Block A
Tian An International Building
Renmin Nan Road
Shenzhen 518 001
☎ (+86) 7 55-2 28 91 04
Fax (+86) 7 55-2 28 02 17

Germany (D)

Infineon Technologies AG
Siemensstraße 31-33
71254 Ditzingen/Stuttgart
☎ (+49) 7 1 56-1 79 19-10
Fax (+49) 7 1 56-1 79 19-90

Infineon Technologies AG
Völklinger Straße 4
40219 Düsseldorf
☎ (+49) 2 11-20 95 49 0
Fax (+49) 2 11-20 95 49 60

Infineon Technologies AG
Naegelsbachstraße 26
91052 Erlangen
☎ (+49) 91 31-97 00 1-0
Fax (+49) 91 31-97 00-99

Infineon Technologies AG
Paderborner Straße 1
30539 Hannover
☎ (+49) 5 11-87 65 62 0
Fax (+49) 5 11-87 65 62 90

Infineon Technologies AG
Rosenheimer Straße 116
81669 München
☎ (+49) 89-23 40
Fax (+49) 89-23 42 46 94

Infineon Technologies AG
Südwestpark 65
90449 Nürnberg
☎ (+49) 9 11-2 52 93 0
Fax (+49) 9 11-2 52 93 93

Denmark (DK)

Infineon Technologies Nordic A/S
Herlev Hovedgade 201A
DK 2730 Herlev
☎ (+45) 44 50 77 00
Fax (+45) 44 50 77 01

Finland (FIN)

Infineon Technologies Nordic OY
Visitor's Address Linnouitustie 4A
P.O. Box 276
FIN-02601 Espoo
☎ (+3 58) 10-680 84 00
Fax (+3 58) 10-680 84 01

France (F)

Infineon Technologies France SAS
39 - 47, Bd. Ornano
93527 Saint-Denis CEDEX 2
☎ (+33) 1-48 09 72 00
Fax (+33) 1-48 09 72 90

India (IND)

Infineon Technologies
India Pvt. Ltd.
10th Floor, Discoverer Building
International Technology Park
Whitefield Road
Bangalore 560 066, India
☎ (+91) 80 8 41 00-17/18
Fax (+91) 80 8 41 00 12

Ireland (IRL)

Infineon Technologies Ireland Ltd.
69 Fitzwilliam Lane
Dublin 2
☎ (+35) 31-79 99 500
Fax (+35) 31-79 99 501

Israel (IL)

Nisko Ltd.
2A, Habarzel Street
Tel Aviv 69710
☎ (+9 72) 3-7 65 73 00
Fax (+9 72) 3-7 65 73 33

Italy (I)

Infineon Technologies Italia S.r.l.
Via Vipiteno, 4
20128 Milano
☎ (+39) 022 52 04-1
Fax (+39) 022 52 04-43 95

Japan (J)

Infineon Technologies Japan K.K.
Takanawa Park Tower 8F/9F/12F/17F
3-20-14, Higashi-Gotanda,
Shinagawa-ku,
Tokyo 141-0022
☎ (+81) 3 54 49 64 11
Fax (+81) 3 54 49 64 01

Korea (ROK)

Infineon Technologies Korea Co., Ltd.
Room No. 2 & 3, 9th floor
Daelim Acrotel Building
467-6 Dokkock-Dong, Kangnam-Gu
Seoul, Korea 135-971
☎ (+82) 23 46 00-900
Fax (+82) 23 46 00-901/902

Malaysia (MAL)

Infineon Technologies (M) SDN BHD
Krystal Point II
1-4-11/12, Lebuh Bukit Kecil 6
11900 Bayan Lepas
Penang, Malaysia
☎ (+60) 46 44 77 66
Fax (+60) 46 41 48 72

New Zealand (NZ)

Siemens Components
300 Great South Road
Greenland, Auckland
☎ (+64) 95 20 30 33
Fax (+64) 95 20 15 56

Poland (PL)

Siemens SP. z o.o.
ul. Zupnicza 11
03-821 Warszawa
☎ (+48) 22-8 70 91 50
Fax (+48) 22-8 70 91 59

Portugal (P)

Siemens S.A.
OG Componentes Electronicos
Rua Irmaos Siemens, 1
Alfragide
2720-093 Amadora
☎ (+3 51) 21-4 17 85 90
Fax (+3 51) 21-4 17 80 83

Russia (RUS)

INTECH electronics
ul. Smolnaja 24a/1203
125 445 Moscow
☎ (+70) 95-4 51 97 37
Fax (+70) 95-4 51 86 08

Singapore (SGP)

Infineon Technologies Asia
Pacific Pte. Ltd.
25 New Industrial Road
KHL Building
Singapore 536 211
☎ (+65) 68 40 07 32
Fax (+65) 68 40 00 77

South Africa (ZA)

Siemens Components
P.O. Box 3438
Halfway House 1685
Gauteng
☎ (+27) 11 652-20 00
Fax (+27) 11 652-25 73

Spain (E)

Siemens S.A.
División Componentes
Ronda de Europa, 5
28760 Tres Cantos-Madrid
☎ (+34) 91-5 14 71 54
Fax (+34) 91-5 14 70 13

Sweden (S)

Infineon Technologies Nordic AB
P.O. Box 46
164 93 Kista
☎ (+46) 8-7 03 59 00
Fax (+46) 8-7 03 59 01

Switzerland (CH)

Infineon Technologies
Switzerland AG
Badenerstraße 623
P.O. Box. 1570
8048 Zürich
☎ (+41) 1-4 97 80 40
Fax (+41) 1-4 97 80 50

Taiwan (RC)

Infineon Technologies
Taiwan Ltd.
12F-1, No. 3-2 Yuan Qu Street
Nan Kang Software Park
Twain 115, R.O.C.
☎ (+8 86) 2-26 55 75 00
Fax (+8 86) 2-26 55 75 01-8

Turkey (TR)

Siemens Sanayi ve Ticaret S.A.
Yakacik Yolu No: 111
34861 Kartal, Istanbul
☎ (+90) 21 64 59 28 51
Fax (+90) 21 64 19 31 90

United Kingdom (GB)

Infineon Technologies UK Ltd.
Infineon House
Fleet Mill
Minley Road
Fleet, Hampshire GU51 2RD
☎ (+44) 12 52-77 22 00
Fax (+44) 12 52-77 22 01

U.S.A. (USA)

Infineon Technologies
North America Corp.
3700 West Parmer Lane, Suite 102
Austin, TX 78727
☎ (+1) 51 23 41-71 27
Fax (+1) 51 23 41-99 26

U.S.A. (USA)

Infineon Technologies
North America Corp.
8203 Willow Place South, Suite 660
Houston, TX 77070
☎ (+1) 28 17 74-05 55
Fax (+1) 28 17 74-05 61

Infineon Technologies
North America Corp.
1050 Route 22
Iselin, NJ 08830
☎ (+1) 73 28 55-92 00
Fax (+1) 73 28 55-92

Infineon Technologies
North America Corp.
2529 Commerce Drive
Kokomo, IN 46902
☎ (+1) 7 65-4 56 19 28
Fax (+1) 7 65-4 56 38 36

eupec Inc.
1050 Route 22
Lebanon, NJ 08833
☎ (+34) 91-5 14 71 54
Fax (+1) 90 8-2 36 56 21

Infineon Technologies
North America Corp.
21800 Haggerty Road, Suite 112
Northville, MI 48167
☎ (+1) 2 48-3 74 08 90
Fax (+1) 2 48-3 74 25 01

Infineon Technologies
North America Corp.
2901 Dallas N. Tollway, Suite 370
Plano, TX 75093
☎ (+1) 97 23 78-49 46
Fax (+1) 97 24 03-97 89

Infineon Technologies
North America Corp.
3000 CentreGreen Way
Raleigh, NC 27513
☎ (+1) 91 96 77-27 00
Fax (+1) 91 96 78 19 34

Infineon Technologies
North America Corp.
6170 Cornerstone Ct East, Suite 240
San Diego, CA 92121
☎ (+1) 85 85 26-22 01
Fax (+1) 85 85 26-22 02

Infineon Technologies Corporation
1730 North First Street
San Jose, CA 95112
☎ (+1) 4 08-5 01 60 00
Fax (+1) 4 08-5 01 24 24

Infineon Technologies
North America Corp.
1901 N. Roselle Rd., Suite 1020
Schaumburg, IL 60195
☎ (+1) 84 78 84-70 09
Fax (+1) 84 78 84-75 99

Infineon Technologies
North America Corp.
238 Littleton Rd, Suite 200
Westford, MA 01886
☎ (+1) 97 86 92-05 50
Fax (+1) 97 86 92-23 09

* and representative offices

X-ON Electronics

Largest Supplier of Electrical and Electronic Components

Click to view similar products for [MOSFET](#) category:

Click to view products by [Infineon](#) manufacturer:

Other Similar products are found below :

[614233C](#) [648584F](#) [IRFD120](#) [JANTX2N5237](#) [FCA20N60_F109](#) [FDZ595PZ](#) [2SK2545\(Q,T\)](#) [405094E](#) [423220D](#) [TPCC8103,L1Q\(CM](#)
[MIC4420CM-TR](#) [VN1206L](#) [614234A](#) [715780A](#) [NTNS3166NZT5G](#) [SSM6J414TU,LF\(T](#) [751625C](#) [BUK954R8-60E](#) [GROUP A 5962-](#)
[8877003PA](#) [NTE6400](#) [SQJ402EP-T1-GE3](#) [2SK2614\(TE16L1,Q\)](#) [2N7002KW-FAI](#) [DMN1017UCP3-7](#) [EFC2J004NUZTDG](#) [ECH8691-TL-W](#)
[FCAB21350L1](#) [P85W28HP2F-7071](#) [DMN1053UCP4-7](#) [NTE221](#) [NTE222](#) [NTE2384](#) [NTE2903](#) [NTE2941](#) [NTE2945](#) [NTE2946](#) [NTE2960](#)
[NTE2967](#) [NTE2969](#) [NTE2976](#) [NTE6400A](#) [NTE2910](#) [NTE2916](#) [NTE2956](#) [NTE2911](#) [DMN2080UCB4-7](#) [TK10A80W,S4X\(S](#)
[SSM6P54TU,LF](#) [SSM6P69NU,LF](#) [DMP22D4UFO-7B](#)