

TCA3727G

2-phase Stepper Motor Driver
Bipolar IC

Automotive Power



Never stop thinking

2-phase Stepper Motor Driver Bipolar IC

TCA3727G



Features

- 2 × 0.75 amp. / 50 V outputs
- Integrated driver, control logic and current control (chopper)
- Fast free-wheeling diodes
- Max. supply voltage 52 V
- Outputs free of crossover current
- Offset-phase turn-ON of output stages
- Z-diode for logic supply
- Low standby-current drain
- Full, half, quarter, mini step
- Green (RoHS compliant) thermally enhanced SO package
- AEC Qualified

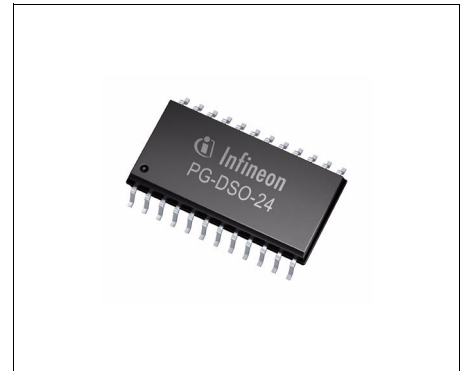

PG-DSO-24-13

Description

TCA3727G is a bipolar, monolithic IC for driving bipolar stepper motors, DC motors and other inductive loads that operate on constant current. The control logic and power output stages for two bipolar windings are integrated on a single chip which permits switched current control of motors with 0.75 A per phase at operating voltages up to 50 V.

The direction and value of current are programmed for each phase via separate control inputs. A common oscillator generates the timing for the current control and turn-on with phase offset of the two output stages. The two output stages in a full-bridge configuration have integrated, fast free-wheeling diodes and are free of crossover current. The logic is supplied either separately with 5 V or taken from the motor supply voltage by way of a series resistor and an integrated Z-diode. The device can be driven directly by a microprocessor with the possibility of all modes from full step through half step to mini step.

Type	Package	Marking
TCA3727G	PG-DSO-24-13	TCA 3727G

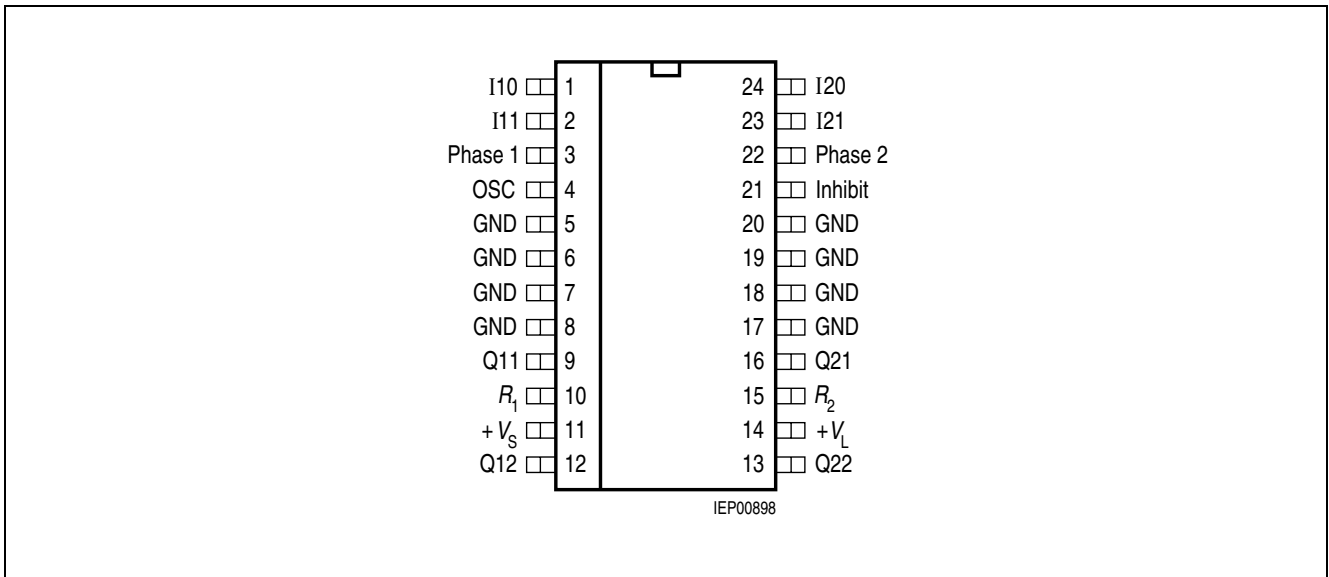

Figure 1 Pin Configuration (top view)

Table 1 Pin Definitions and Functions

Pin No.	Function
1, 2, 23, 24	Digital control inputs IX0, IX1 for the magnitude of the current of the particular phase. See Table 2 .
3	Input Phase 1 ; controls the current through phase winding 1. On H-potential the phase current flows from Q11 to Q12, on L-potential in the reverse direction.
5, 6, 7, 8, 17, 18, 19, 20	Ground ; all pins are connected internally.
4	Oscillator ; works at approx. 25 kHz if this pin is wired to ground across 2.2 nF.
10	Resistor R₁ for sensing the current in phase 1.
9, 12	Push-pull outputs Q11, Q12 for phase 1 with integrated free-wheeling diodes.
11	Supply voltage ; block to ground, as close as possible to the IC, with a stable electrolytic capacitor of at least 10 μF in parallel with a ceramic capacitor of 220 nF.
14	Logic supply voltage ; either supply with 5 V or connect to +V _S across a series resistor. A Z-diode of approx. 7 V is integrated. In both cases block to ground directly on the IC with a stable electrolytic capacitor of 10 μF in parallel with a ceramic capacitor of 100 nF.
13, 16	Push-pull outputs Q22, Q21 for phase 2 with integrated free wheeling diodes.
15	Resistor R₂ for sensing the current in phase 2.
21	Inhibit input ; the IC can be put on standby by low potential on this pin. This reduces the current consumption substantially.
22	Input phase 2 ; controls the current flow through phase winding 2. On H-potential the phase current flows from Q21 to Q22, on L potential in the reverse direction.

Table 2 Digital Control Inputs IX0, IX1

typical I_{max} with $R_{sense} = 1 \Omega$, 750 mA

IX1	IX0	Phase Current	Example of Motor Status
H	H	0	No current
H	L	$1/3 I_{max}$	Hold
L	H	$2/3 I_{max}$	Set
L	L	I_{max}	Accelerate

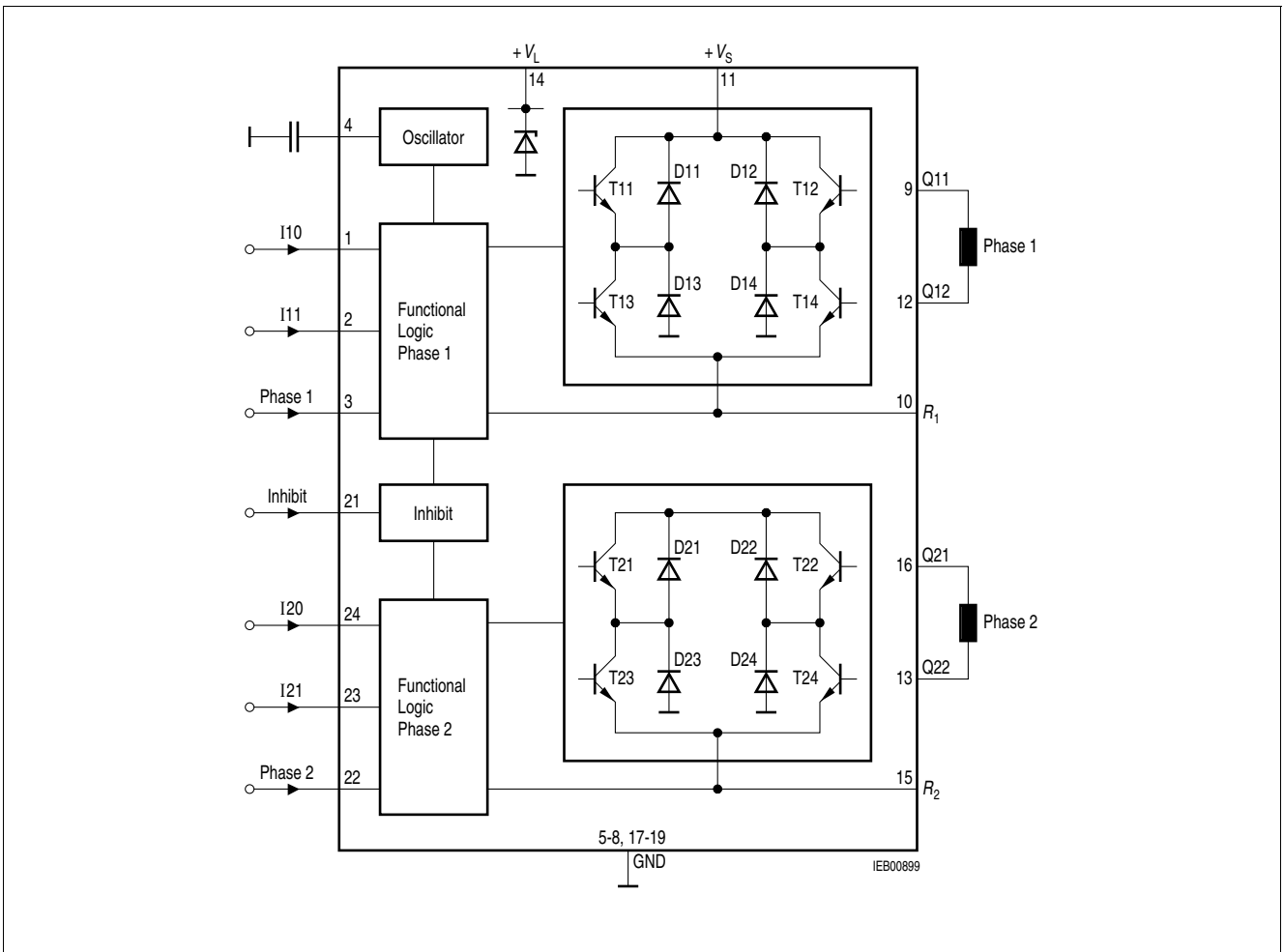

Figure 2 Block Diagram TCA 3727G

Table 3 Absolute Maximum Ratings
 $T_A = -40$ to 125 °C

Parameter	Symbol	Limit Values		Unit	Remarks
		Min.	Max.		
Supply voltage	V_S	0	52	V	–
Logic supply voltage	V_L	0	6.5	V	Z-diode
Z-current of V_L	I_L	–	50	mA	–
Output current	I_Q	-1	1	A	–
Ground current	I_{GND}	-2	2	A	–
Logic inputs	V_{IXX}	-6	$V_L + 0.3$	V	IXX; Phase 1, 2; Inhibit
R_1, R_2 , oscillator input voltage	V_{RX}, V_{OSC}	-0.3	$V_L + 0.3$	V	–
Junction temperature	T_j	–	125	°C	–
		–	150	°C	max. 10,000 h
Storage temperature	T_{stg}	-50	125	°C	–

Note: Stresses above those listed here may cause permanent damage to the device. Exposure to absolute maximum rating conditions for extended periods may affect device reliability.

Table 4 Operating Range

Parameter	Symbol	Limit Values		Unit	Remarks
		Min.	Max.		
Supply voltage	V_S	5	50	V	–
Logic supply voltage	V_L	4.5	6.5	V	without series resistor
Case temperature	T_C	-40	110	°C	measured on pin 5 $P_{diss} = 2$ W
Output current	I_Q	-1000	1000	mA	–
Logic inputs	V_{IXX}	-5	V_L	V	IXX; Phase 1, 2; Inhibit

Thermal Resistances

Junction ambient	$R_{th\ ja}$	–	75	K/W	PG-DSO-24-13
Junction ambient (soldered on a 35 μ m thick 20 cm ² PC board copper area)	$R_{th\ ja}$	–	50	K/W	PG-DSO-24-13
Junction case	$R_{th\ jc}$	–	15	K/W	measured on pin 5 PG-DSO-24-13

Note: In the operating range, the functions given in the circuit description are fulfilled.

Table 5 Characteristics
 $V_S = 40\text{ V}; V_L = 5\text{ V}; -25\text{ °C} \leq T_j \leq 125\text{ °C}$

Parameter	Symbol	Limit Values			Unit	Test Condition
		Min.	Typ.	Max.		
Current Consumption						
from $+V_S$	I_S	–	0.2	0.5	mA	$V_{inh} = L$
from $+V_S$	I_S	–	16	20	mA	$V_{inh} = H$ $I_{Q1/2} = 0, I_{XX} = L$
from $+V_L$	I_L	–	1.7	3	mA	$V_{inh} = L$
from $+V_L$	I_L	–	18	25	mA	$V_{inh} = H$ $I_{Q1/2} = 0, I_{XX} = L$
Oscillator						
Output charging current	I_{OSC}	–	110	–	μA	–
Charging threshold	V_{OSCL}	–	1.3	–	V	–
Discharging threshold	V_{OSCH}	–	2.3	–	V	–
Frequency	f_{OSC}	18	25	35	kHz	$C_{OSC} = 2.2\text{ nF}$
Phase Current Selection ($R_1; R_2$)						
Current Limit Threshold						
No current	$V_{sense\ n}$	–	0	–	mV	$IX0 = H; IX1 = H$
Hold	$V_{sense\ h}$	200	250	300	mV	$IX0 = L; IX1 = H$
Setpoint	$V_{sense\ s}$	460	540	620	mV	$IX0 = H; IX1 = L$
Accelerate	$V_{sense\ a}$	740	825	910	mV	$IX0 = L; IX1 = L$
Logic Inputs (IX1; IX0; Phase x)						
Threshold	V_I	1.4 (H→L)	–	2.3 (L→H)	V	–
L-input current	I_{IL}	-10	–	–	μA	$V_I = 1.4\text{ V}$
L-input current	I_{IL}	-100	–	–	μA	$V_I = 0\text{ V}$
H-input current	I_{IH}	–	–	10	μA	$V_I = 5\text{ V}$
Standby Cutout (inhibit)						
Threshold	$V_{inh} (L\rightarrow H)$	2	3	4	V	–
Threshold	$V_{inh} (H\rightarrow L)$	1.7	2.3	2.9	V	–
Hysteresis	V_{inhhy}	0.3	0.7	1.1	V	–
Internal Z-Diode						
Z-voltage	V_{LZ}	6.5	7.4	8.2	V	$I_L = 50\text{ mA}$
Power Outputs						
Diode Transistor Sink Pair (D13, T13; D14, T14; D23, T23; D24, T24)						
Saturation voltage	V_{satl}	–	0.3	0.6	V	$I_Q = -0.5\text{ A}$
Saturation voltage	V_{satl}	–	0.5	1	V	$I_Q = -0.75\text{ A}$
Reverse current	I_{RI}	–	–	300	μA	$V_Q = 40\text{ V}$
Forward voltage	V_{FI}	–	0.9	1.3	V	$I_Q = 0.5\text{ A}$
Forward voltage	V_{FI}	–	1	1.4	V	$I_Q = 0.75\text{ A}$

Table 5 Characteristics (cont'd)

$V_S = 40\text{ V}$; $V_L = 5\text{ V}$; $-25\text{ °C} \leq T_j \leq 125\text{ °C}$

Parameter	Symbol	Limit Values			Unit	Test Condition
		Min.	Typ.	Max.		
Diode Transistor Source Pair (D11, T11; D12, T12; D21, T21; D22, T22)						
Saturation voltage	V_{satuC}	–	0.9	1.2	V	$I_Q = 0.5\text{ A}$; charge
Saturation voltage	V_{satuD}	–	0.3	0.7	V	$I_Q = 0.5\text{ A}$; discharge
Saturation voltage	V_{satuC}	–	1.1	1.4	V	$I_Q = 0.75\text{ A}$; charge
Saturation voltage	V_{satuD}	–	0.5	1	V	$I_Q = 0.75\text{ A}$; discharge
Reverse current	I_{Ru}	–	–	300	μA	$V_Q = 0\text{ V}$
Forward voltage	V_{Fu}	–	1	1.3	V	$I_Q = -0.5\text{ A}$
Forward voltage	V_{Fu}	–	1.1	1.4	V	$I_Q = -0.75\text{ A}$
Diode leakage current	I_{SL}	–	1	2	mA	$I_F = -0.75\text{ A}$

Note: The listed characteristics are ensured over the operating range of the integrated circuit. Typical characteristics specify mean values expected over the production spread. If not otherwise specified, typical characteristics apply at $T_A = 25\text{ °C}$ and the given supply voltage.

Quiescent Current I_S, I_L versus Supply Voltage V_S)

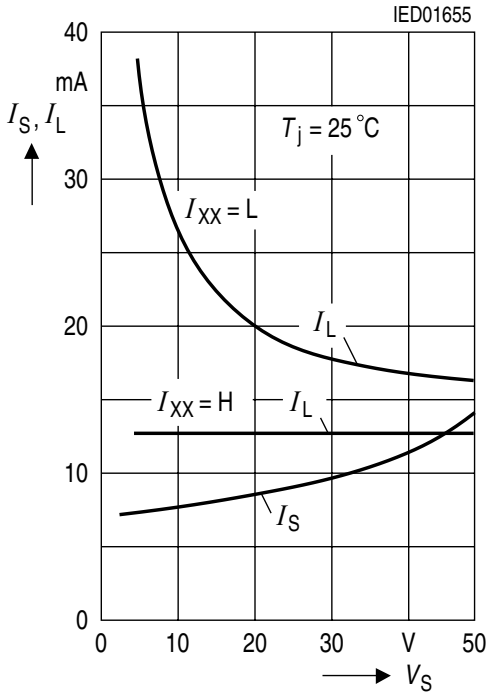

Quiescent Current I_S, I_L versus Junction Temperature T_j

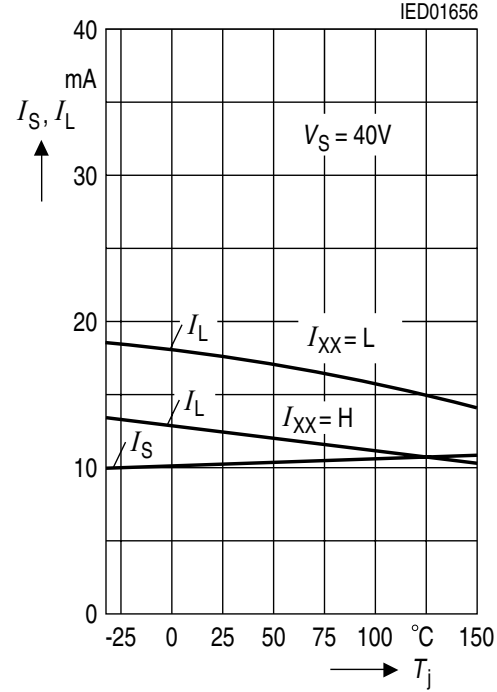

Output Current I_{QX} versus Junction Temperature T_j

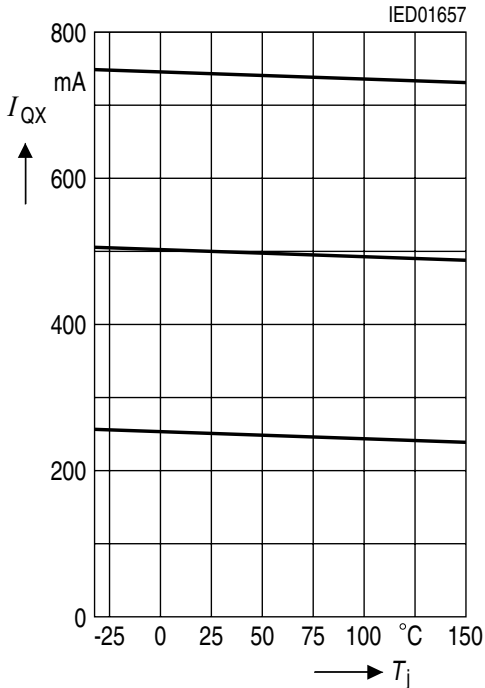

Operating Condition:

- $V_L = 5\text{ V}$
- $V_{Inh} = \text{H}$
- $C_{OSC} = 2.2\text{ nF}$
- $R_{sense} = 1\ \Omega$
- Load: $L = 10\text{ mH}$, $R = 2.4\ \Omega$
- $f_{phase} = 50\text{ Hz}$
- mode: fullstep

Output Saturation Voltages V_{sat} versus Output Current I_Q

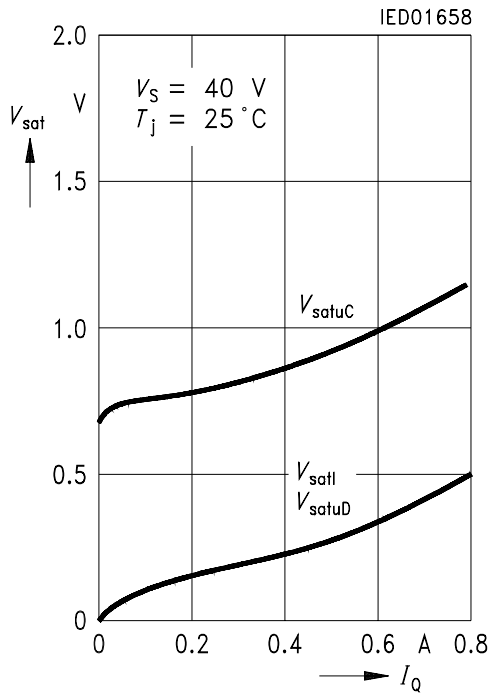

Forward Current I_F of Free-Wheeling Diodes versus Forward Voltages V_F

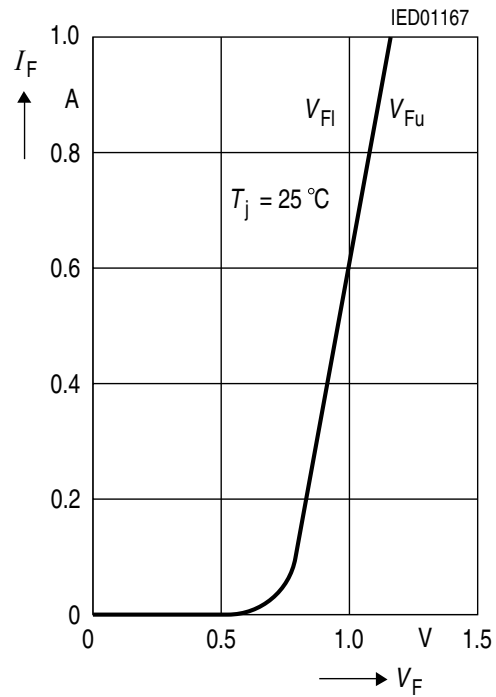

Typical Power Dissipation P_{tot} versus Output Current I_Q (non stepping)

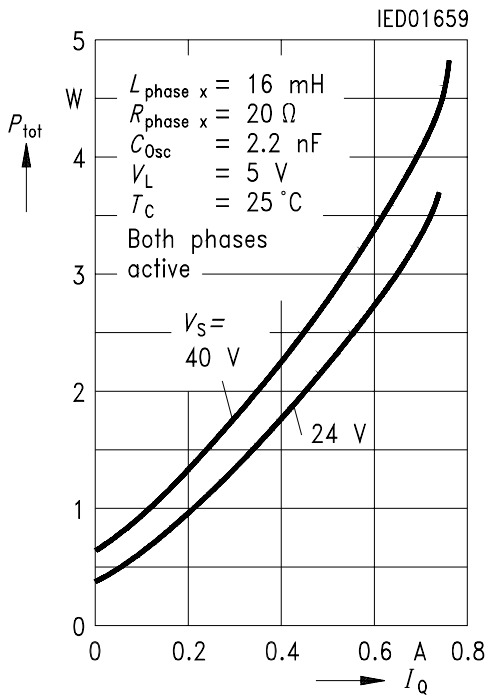

Permissible Power Dissipation P_{tot} versus Case Temperature T_C

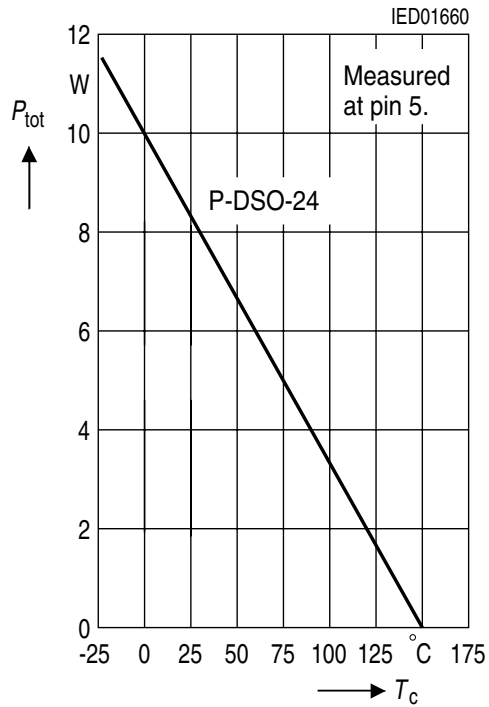

Input Characteristics of IXX, Phase X, Inhibit

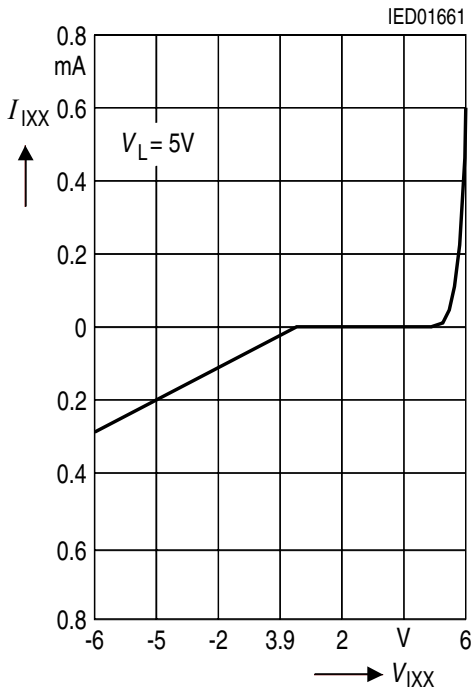

Input Current of Inhibit versus Junction Temperature T_j

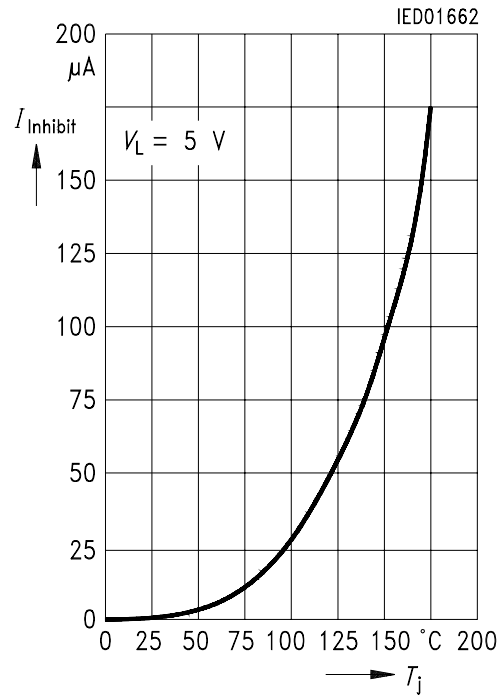

Oscillator Frequency f_{OSC} versus Junction Temperature T_j

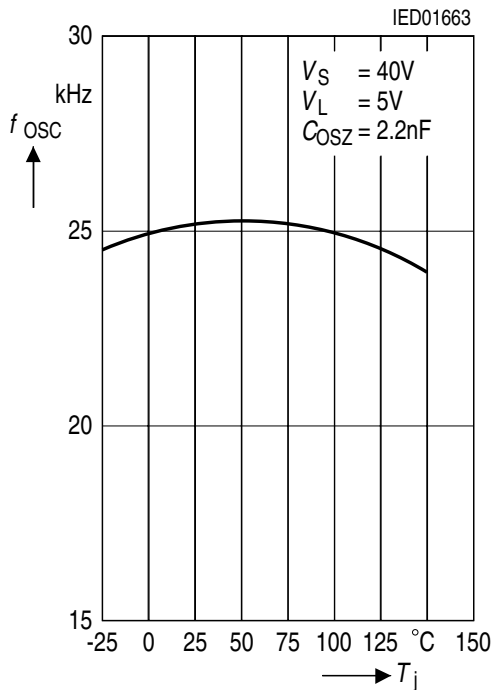

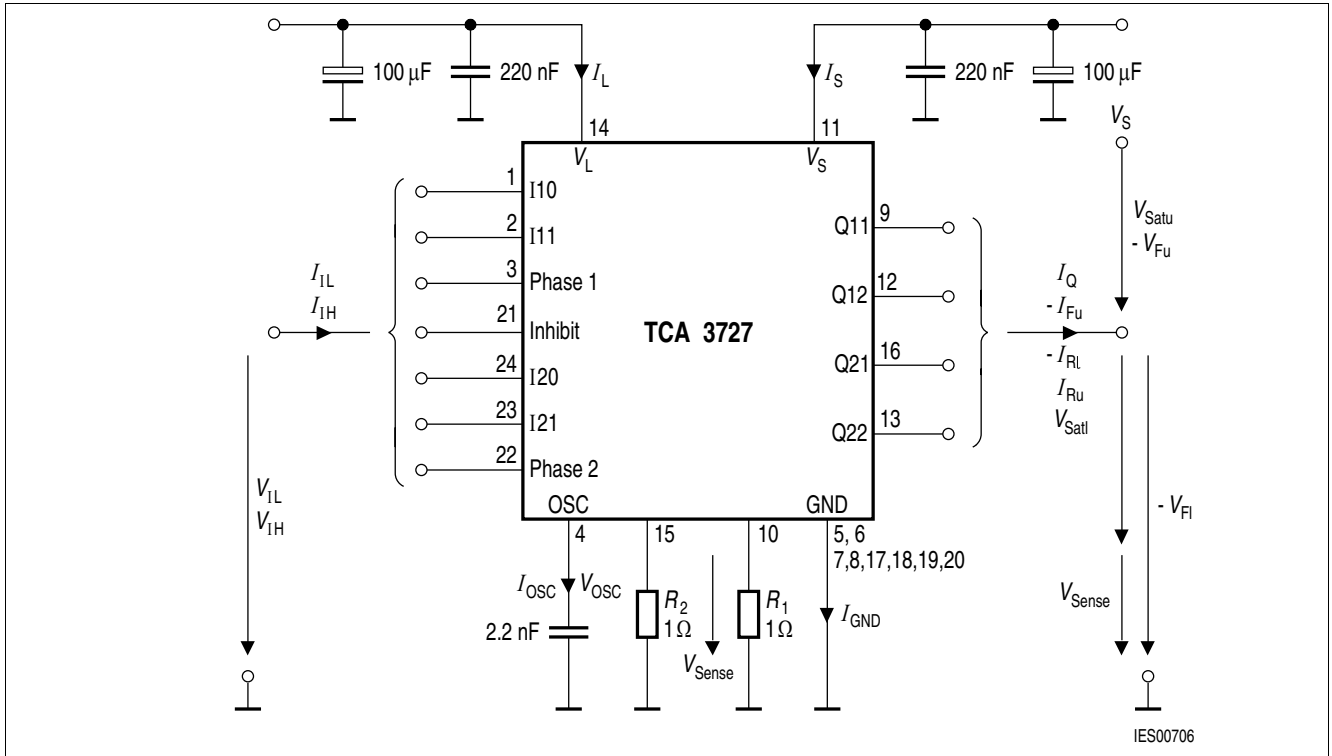

Figure 3 Test Circuit

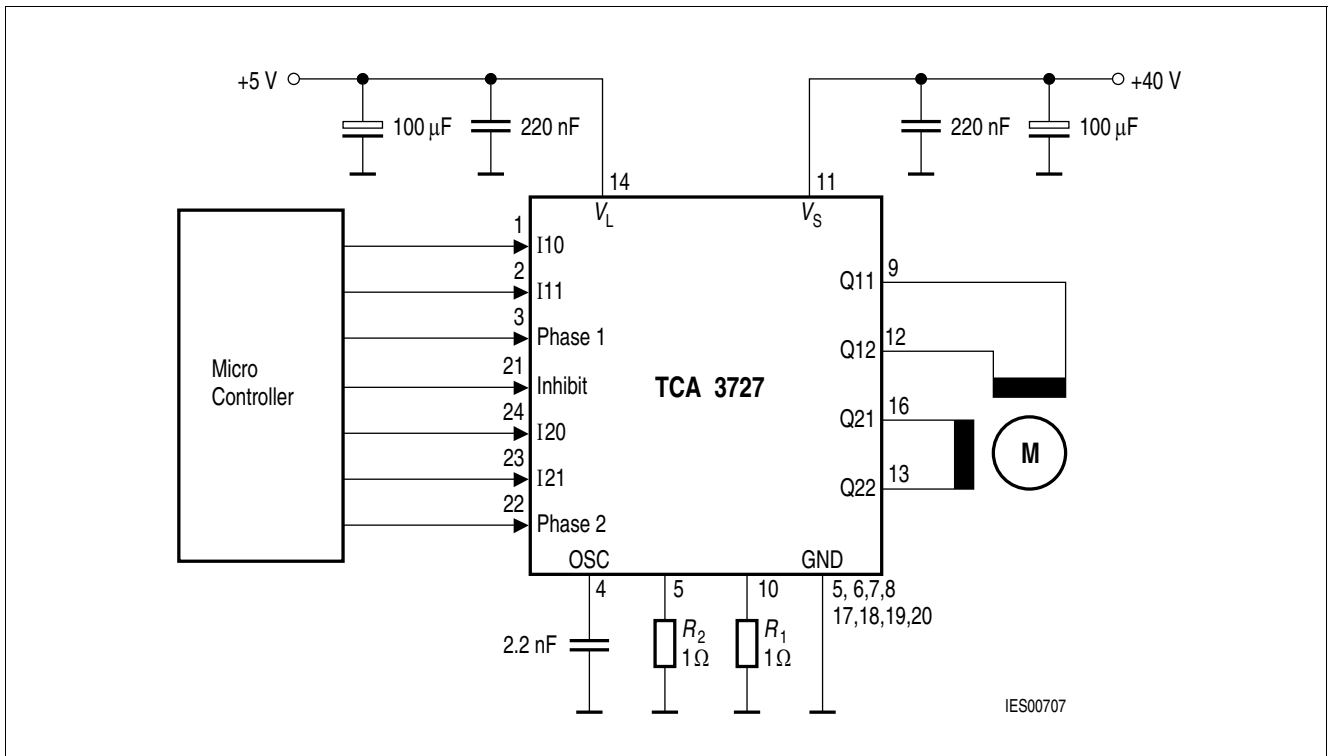

Figure 4 Application Circuit

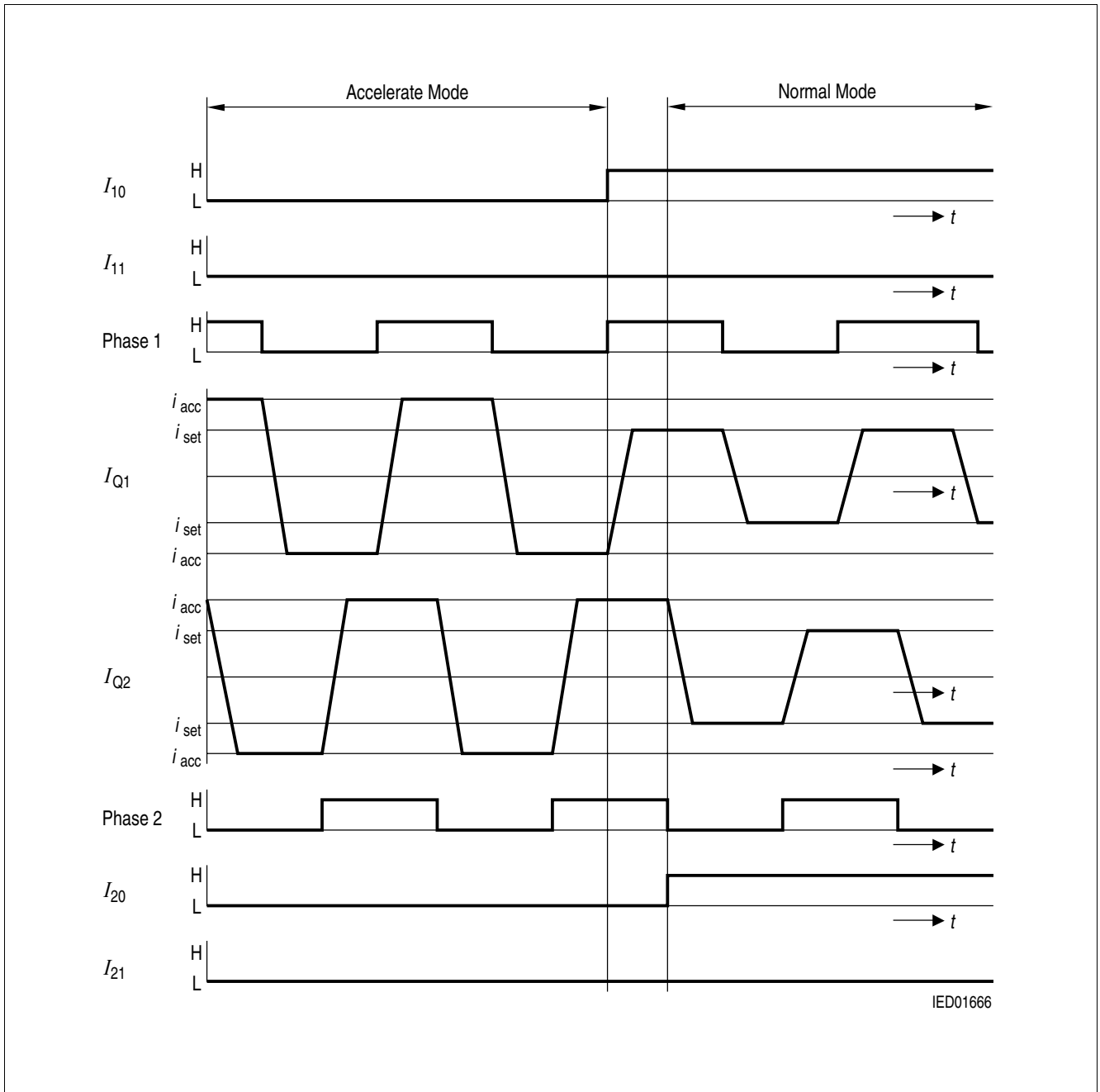

Figure 5 Full-Step Operation

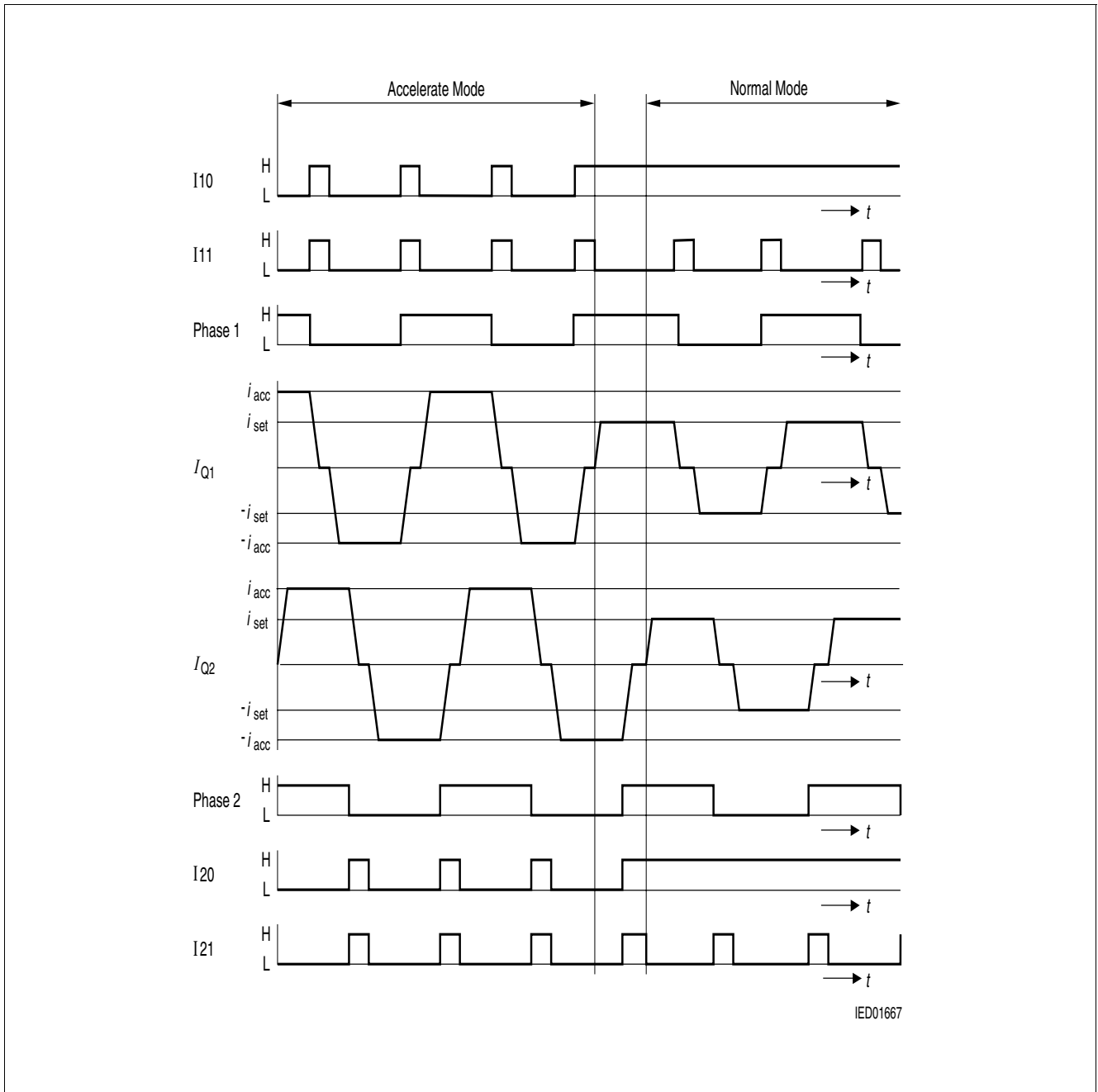
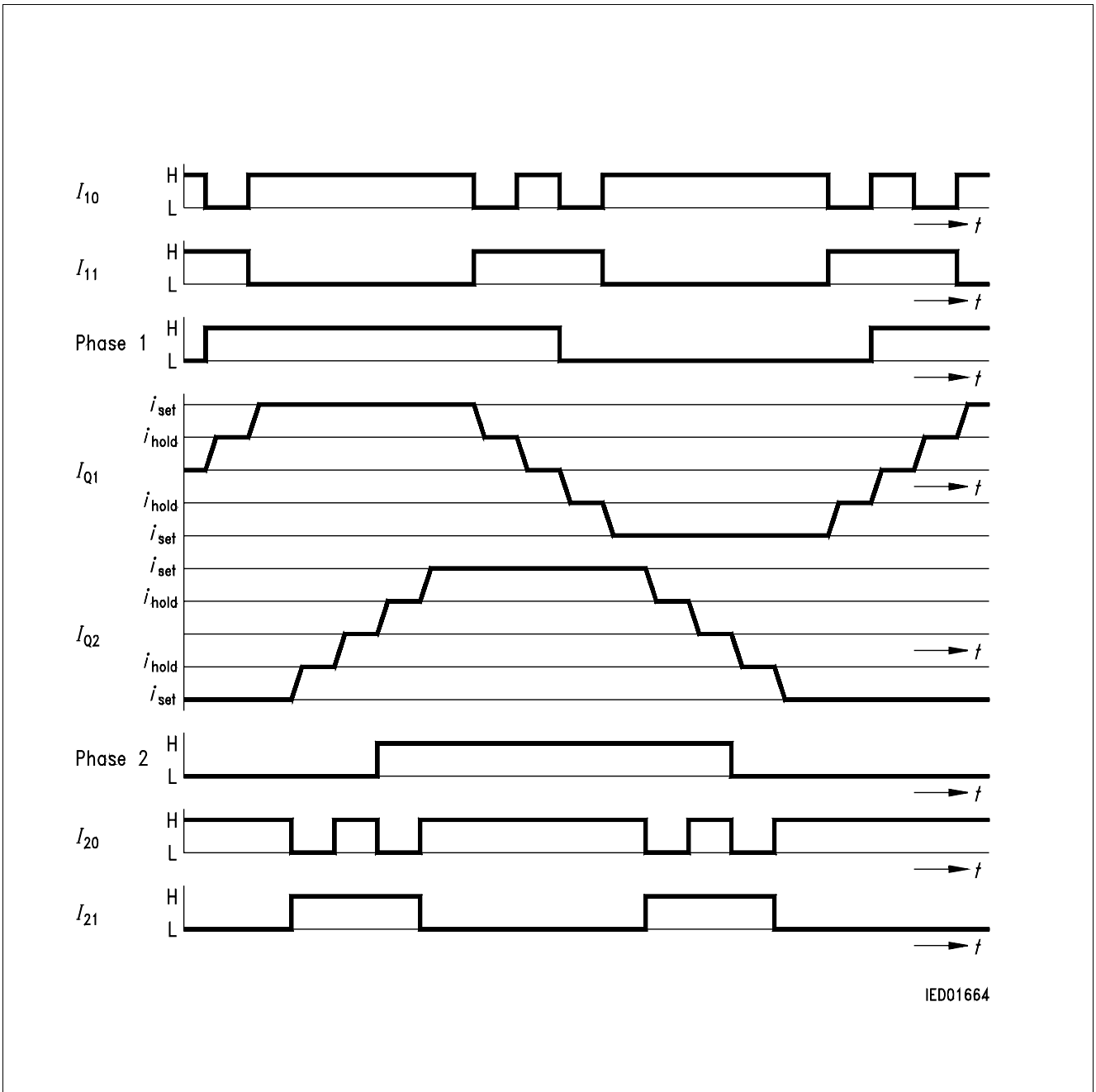

Figure 6 Half-Step Operation



IED01664

Figure 7 Quarter-Step Operation

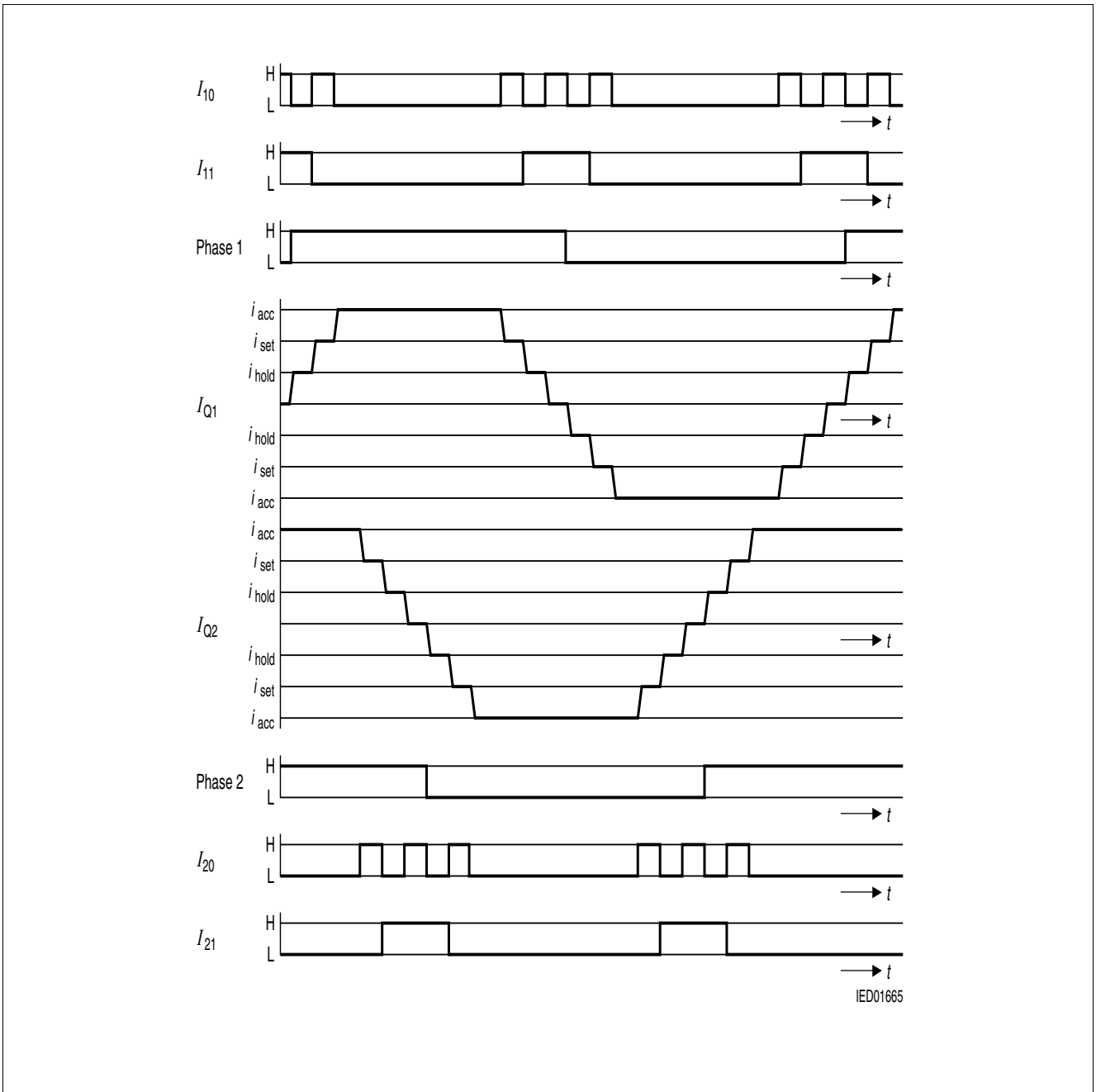

Figure 8 Mini-Step Operation

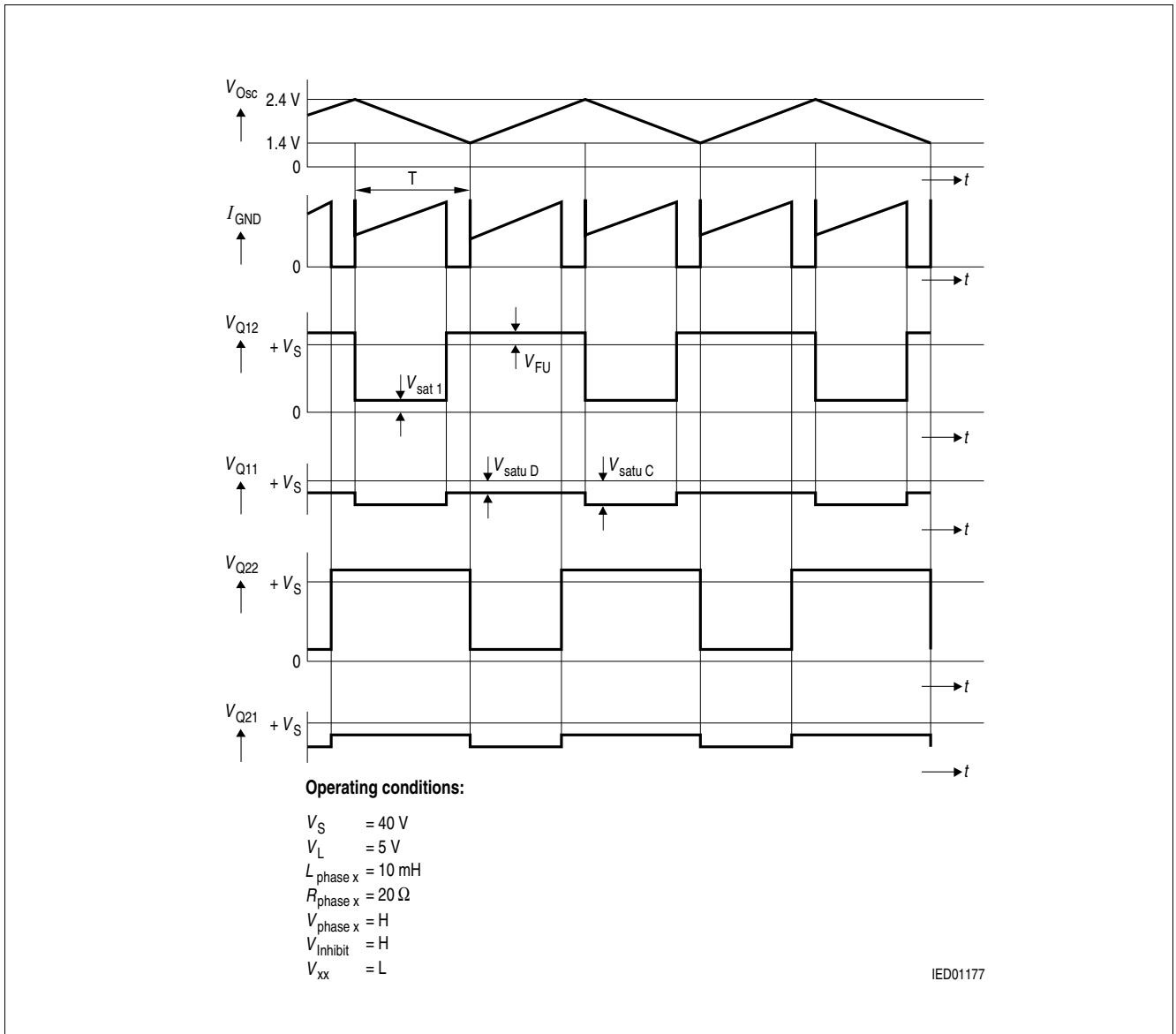

Figure 9 Current Control

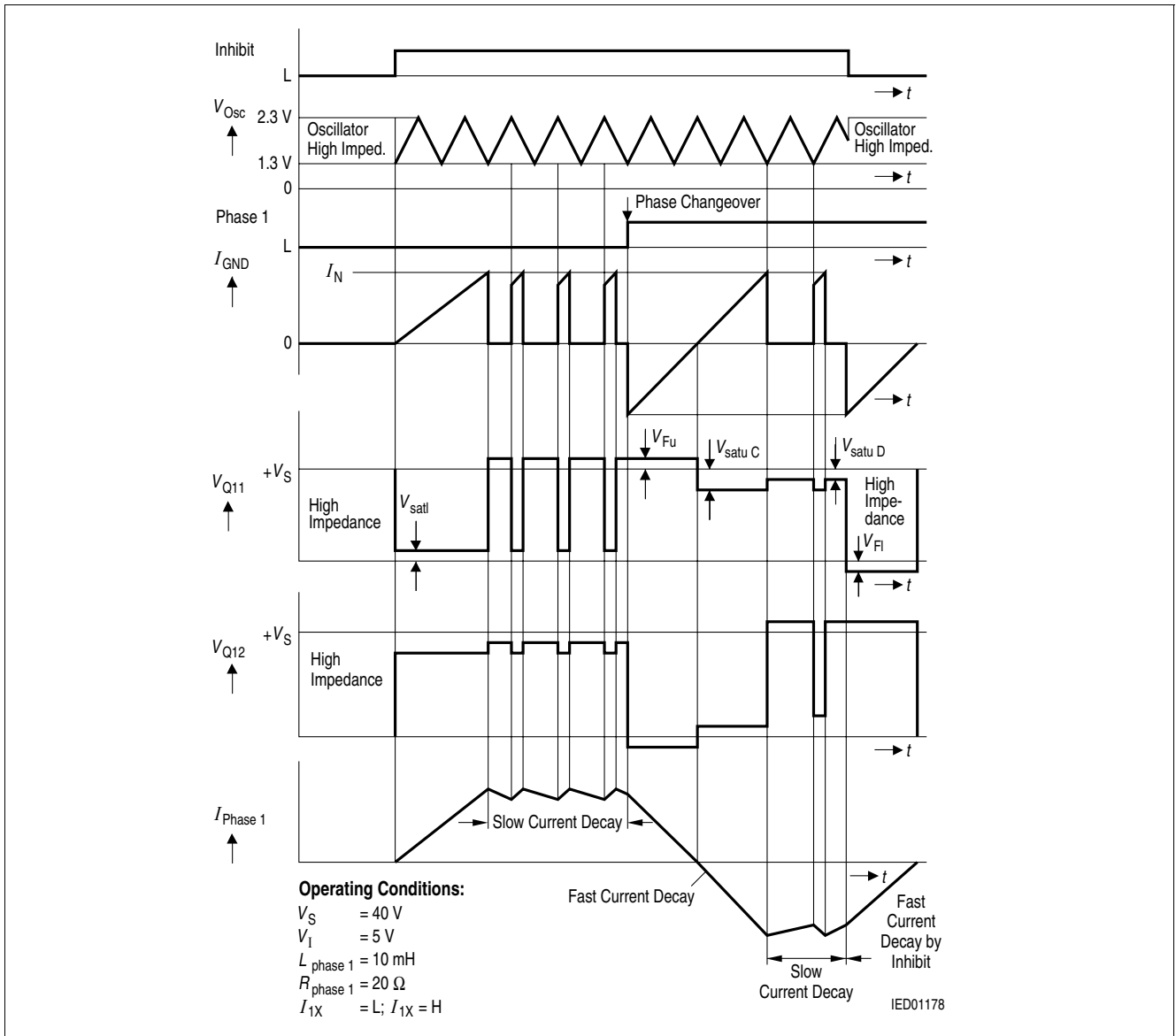

Figure 10 Phase Reversal and Inhibit

Calculation of Power Dissipation

The total power dissipation P_{tot} is made up of

- **saturation losses** P_{sat} (transistor saturation voltage and diode forward voltages),
- **quiescent losses** P_{q} (quiescent current times supply voltage) and
- **switching losses** P_{s} (turn-ON / turn-OFF operations).

The following equations give the power dissipation for chopper operation without phase reversal. This is the worst case, because full current flows for the entire time and switching losses occur in addition.

$$P_{\text{tot}} = 2 \times P_{\text{sat}} + P_{\text{q}} + 2 \times P_{\text{s}} \quad (1)$$

where

- $P_{\text{sat}} \cong I_{\text{N}} \{V_{\text{satI}} \times d + V_{\text{Fu}} (1 - d) + V_{\text{satuC}} \times d + V_{\text{satuD}} (1 - d)\}$
- $P_{\text{q}} = I_{\text{q}} \times V_{\text{S}} + I_{\text{L}} \times V_{\text{L}}$

$$P_{\text{s}} \cong \frac{V_{\text{S}}}{T} \left\{ \frac{i_{\text{D}} \times t_{\text{DON}}}{2} + \frac{i_{\text{D}} + i_{\text{R}} \times t_{\text{ON}}}{4} + \frac{I_{\text{N}}}{2} t_{\text{DOFF}} + t_{\text{OFF}} \right\} \quad (2)$$

- I_{N} = nominal current (mean value)
- I_{q} = quiescent current
- i_{D} = reverse current during turn-on delay
- i_{R} = peak reverse current
- t_{p} = conducting time of chopper transistor
- t_{ON} = turn-ON time
- t_{OFF} = turn-OFF time
- t_{DON} = turn-ON delay
- t_{DOFF} = turn-OFF delay
- T = cycle duration
- d = duty cycle t_{p}/T
- V_{satI} = saturation voltage of sink transistor (T3, T4)
- V_{satuC} = saturation voltage of source transistor (T1, T2) during charge cycle
- V_{satuD} = saturation voltage of source transistor (T1, T2) during discharge cycle
- V_{Fu} = forward voltage of free-wheeling diode (D1, D2)
- V_{S} = supply voltage
- V_{L} = logic supply voltage
- I_{L} = current from logic supply

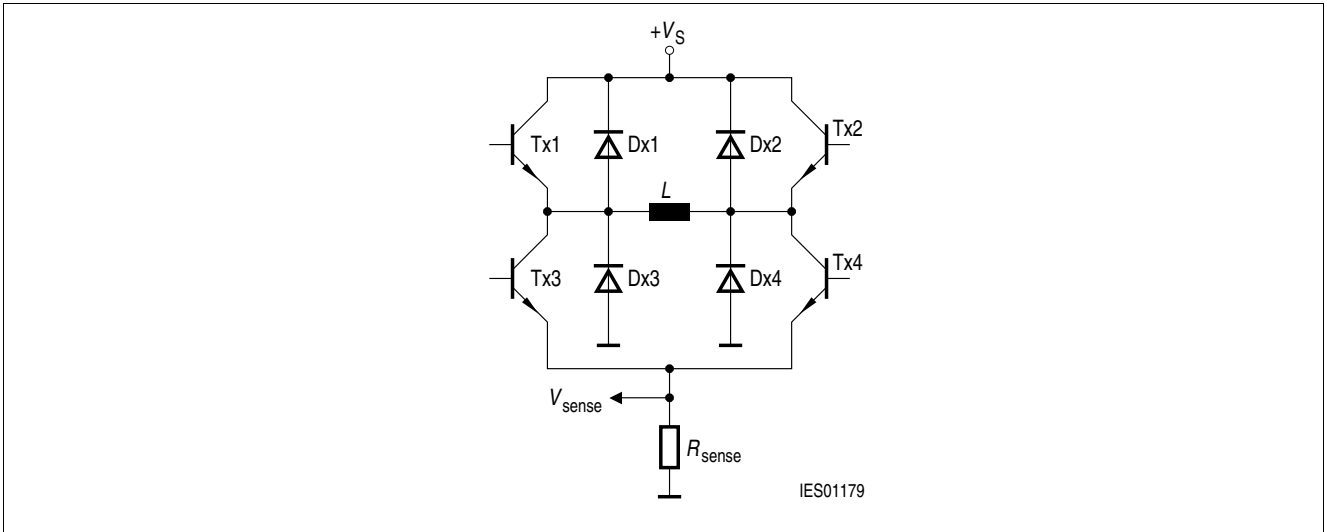

Figure 11

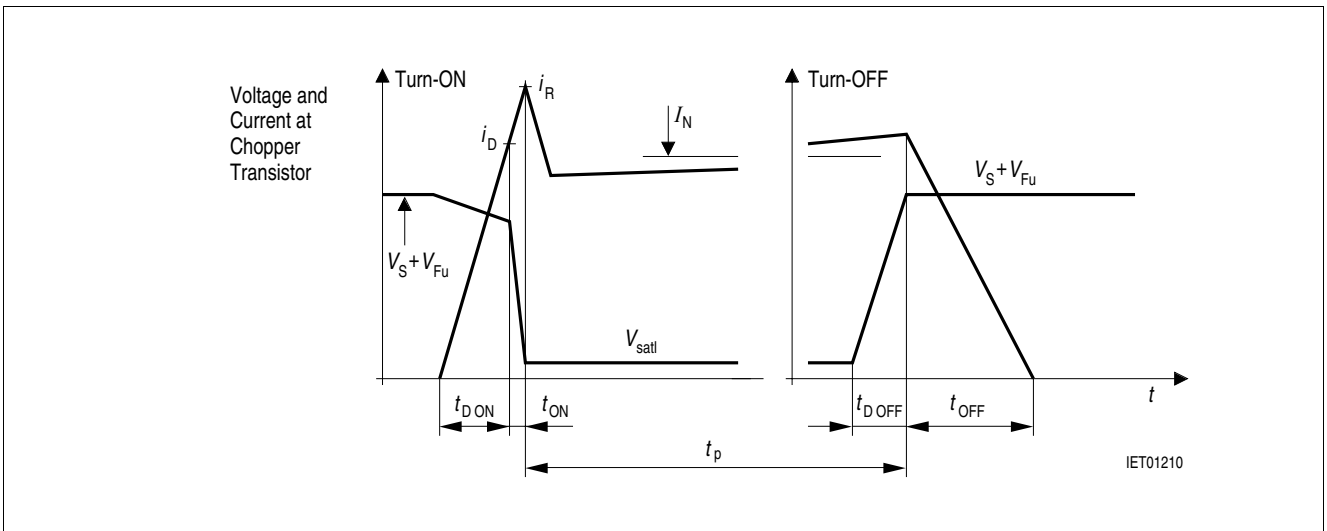

Figure 12

Application Hints

The TCA3727G is intended to drive both phases of a stepper motor. Special care has been taken to provide high efficiency, robustness and to minimize external components.

Power Supply

The TCA3727G will work with supply voltages ranging from 5 V to 50 V at pin V_S . As the circuit operates with chopper regulation of the current, interference generation problems can arise in some applications. Therefore the power supply should be decoupled by a 0.22 μ F ceramic capacitor located near the package. Unstabilized supplies may even afford higher capacities.

Current Sensing

The current in the windings of the stepper motor is sensed by the voltage drop across R_1 and R_2 . Depending on the selected current internal comparators will turn off the sink transistor as soon as the voltage drop reaches certain thresholds (typical 0 V, 0.25 V, 0.5 V and 0.75 V); ($R_1, R_2 = 1 \Omega$). These thresholds are neither affected by variations of V_L nor by variations of V_S .

Due to chopper control fast current rises (up to 10 A/ μ s) will occur at the sensing resistors R_1 and R_2 . To prevent malfunction of the current sensing mechanism R_1 and R_2 should be pure ohmic. The resistors should be wired to GND as directly as possible. Capacitive loads such as long cables (with high wire to wire capacity) to the motor should be avoided for the same reason.

Synchronizing Several Choppers

In some applications synchronous chopping of several stepper motor drivers may be desirable to reduce acoustic interference. This can be done by forcing the oscillator of the TCA3727G by a pulse generator overdriving the oscillator loading currents (approximately $\geq \pm 100 \mu$ A). In these applications low level should be between 0 V and 1 V while high level should be between 2.6 V and V_L .

Optimizing Noise Immunity

Unused inputs should always be wired to proper voltage levels in order to obtain highest possible noise immunity. To prevent crossconduction of the output stages the TCA3727G uses a special break before make timing of the power transistors. This timing circuit can be triggered by short glitches (some hundred nanoseconds) at the Phase inputs causing the output stage to become high resistive during some microseconds. This will lead to a fast current decay during that time. To achieve maximum current accuracy such glitches at the Phase inputs should be avoided by proper control signals.

Thermal Shut Down

To protect the circuit against thermal destruction, thermal shut down has been implemented. To provide a warning in critical applications, the current of the sensing element is wired to input Inhibit. Before thermal shut down occurs Inhibit will start to pull down by some hundred microamperes. This current can be sensed to build a temperature prealarm.

Package Outlines

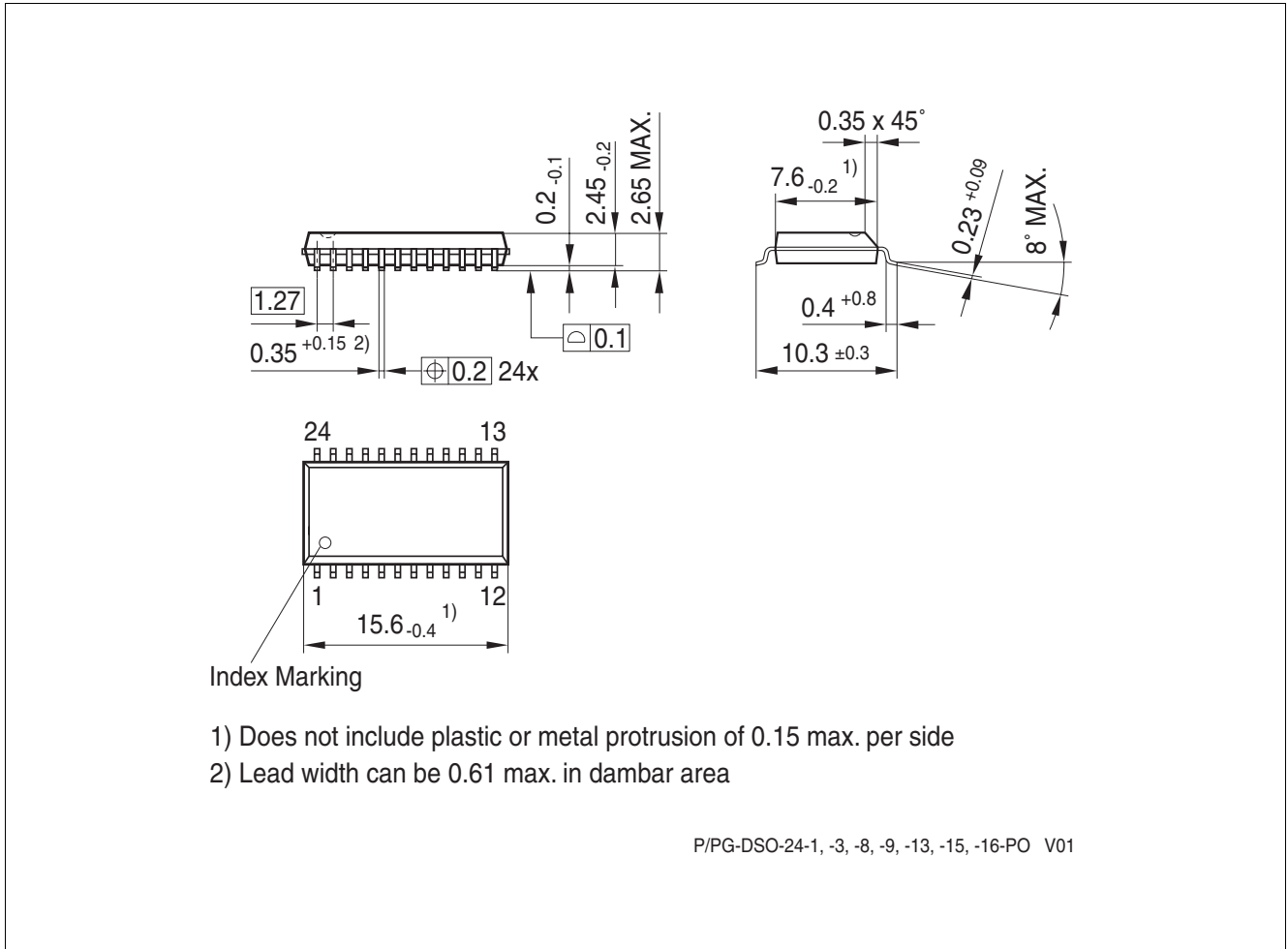

Figure 13 PG-DSO-24-13

Green Product (RoHS compliant)

To meet the world-wide customer requirements for environmentally friendly products and to be compliant with government regulations the device is available as a green product. Green products are RoHS-Compliant (i.e. Pb-free finish on leads and suitable for Pb-free soldering according to IPC/JEDEC J-STD-020).

For further information on alternative packages, please visit our website:
<http://www.infineon.com/packages>.

Dimensions in mm

Revision History

Revision	Date	Changes
2.2	2009-01-22	Final Green Data Sheet version of TCA3727G Page 11 : Removed P-DIP-20 reference in Permissible Power Dissipation vs. Case Temperature curve. Page 13 : Updated Figure 3 and 4 to PG-DSO-24-13 pinout
2.1	2008-12-04	Initial version of RoHS-compliant derivate of TCA3727 Page 1: AEC certified statement added Page 1 and 24: added RoHS compliance statement and Green product feature Page 1 and 24: Package changed to RoHS compliant version Page 25-26: added Revision History, updated Legal Disclaimer
2.0	2007-06-25	Final Data Sheet
1.0	1998-12-16	Initial Release

Edition 2009-01-22

**Published by
Infineon Technologies AG
81726 Munich, Germany**

**© 2009 Infineon Technologies AG
All Rights Reserved.**

Legal Disclaimer

The information given in this document shall in no event be regarded as a guarantee of conditions or characteristics. With respect to any examples or hints given herein, any typical values stated herein and/or any information regarding the application of the device, Infineon Technologies hereby disclaims any and all warranties and liabilities of any kind, including without limitation, warranties of non-infringement of intellectual property rights of any third party.

Information

For further information on technology, delivery terms and conditions and prices, please contact the nearest Infineon Technologies Office (www.infineon.com).

Warnings

Due to technical requirements, components may contain dangerous substances. For information on the types in question, please contact the nearest Infineon Technologies Office.

Infineon Technologies components may be used in life-support devices or systems only with the express written approval of Infineon Technologies, if a failure of such components can reasonably be expected to cause the failure of that life-support device or system or to affect the safety or effectiveness of that device or system. Life support devices or systems are intended to be implanted in the human body or to support and/or maintain and sustain and/or protect human life. If they fail, it is reasonable to assume that the health of the user or other persons may be endangered.

X-ON Electronics

Largest Supplier of Electrical and Electronic Components

Click to view similar products for [Motor/Motion/Ignition Controllers & Drivers](#) category:

Click to view products by [Infineon](#) manufacturer:

Other Similar products are found below :

[FSB50550TB2](#) [FSBF15CH60BTH](#) [MSVCPM2-63-12](#) [MSVGW45-14-2](#) [MSVGW54-14-3](#) [MSVGW54-14-5](#) [NTE7043](#) [LA6565VR-TLM-E](#)
[LB11650-E](#) [LB1837M-TLM-E](#) [LB1845DAZ-XE](#) [LC898300XA-MH](#) [SS30-TE-L-E](#) [26700](#) [LV8281VR-TLM-H](#) [BA5839FP-E2](#) [IRAM236-1067A](#) [LA6584JA-AH](#) [LB11847L-E](#) [NCV70501DW002R2G](#) [AH293-PL-B](#) [STK672-630CN-E](#) [TND315S-TL-2H](#) [FNA23060](#) [FSB50250AB](#)
[FNA41060](#) [MSVB54](#) [MSVBTC50E](#) [MSVCPM3-54-12](#) [MSVCPM3-63-12](#) [MSVCPM4-63-12](#) [MSVTA120](#) [FSB50550AB](#)
[NCV70501DW002G](#) [LC898301XA-MH](#) [LV8413GP-TE-L-E](#) [MSVGW45-14-3](#) [MSVGW45-14-4](#) [MSVGW45-14-5](#) [MSVGW54-14-4](#)
[STK984-091A-E](#) [SLA7026M](#) [MP6519GQ-Z](#) [LB11651-E](#) [IRSM515-025DA4](#) [LV8127T-TLM-H](#) [NCP81382MNTXG](#) [TDA21801](#)
[LB11851FA-BH](#) [NCV70627DQ001R2G](#)