

OPTIREG™ Linear TLE4264-2

5-V low drop fixed voltage regulator



Features

- Output voltage tolerance $\leq \pm 3\%$ ($\pm 2\%$ up to 50 mA)
- 150 mA current capability
- Low-drop voltage
- Very low current consumption: 40 μA
- Overtemperature protection
- Short-circuit proof
- Suitable for use in automotive electronics
- Reverse polarity proof
- Green Product (RoHS compliant)

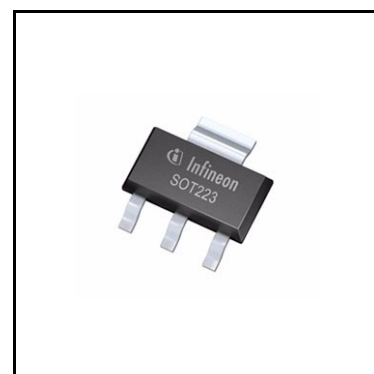

Potential applications

General automotive applications.

Product validation

Qualified for automotive applications. Product validation according to AEC-Q100/101.

Description

The OPTIREG™ Linear TLE4264-2 is a monolithic integrated low-drop fixed voltage regulator which can supply loads up to 150 mA. It is functional compatible to the TLE4264, but has a reduced quiescent current of typ. 40 μA . The TLE4264-2 is especially designed for all applications which require very low quiescent currents. The device is available in the small surface mounted PG-SOT223-4 package. The device is pin compatible to the TLE4264. The regulator is designed to supply microprocessor systems under the severe condition of automotive applications and is therefore equipped with additional protection against overload, short-circuit and overtemperature. Of course the TLE4264-2 can be used in all other applications, wherever a stabilized voltage is required.

An input voltage V_I in the range of $5.5\text{ V} < V_I < 45\text{ V}$ is regulated to $V_{Q, \text{nom}} = 5\text{ V}$ with an accuracy of $\pm 3\%$. An accuracy of $\pm 2\%$ is kept for a load current range up to 50 mA.

The device operates in the temperature range of $T_j = -40^\circ\text{C}$ to 150°C .

Type	Package	Marking
TLE4264-2G	PG-SOT223-4	4264-2

Table of contents

	Features	1
	Potential applications	1
	Product validation	1
	Description	1
	Table of contents	2
1	Block diagram	3
2	Pin configuration	4
3	General product characteristics	5
3.1	Absolute maximum ratings	5
3.2	Electrical characteristics	6
4	Functional description	7
4.1	Application circuit	7
5	Typical performance characteristics	8
6	Package information	10
7	Revision history	11

Block diagram

1 Block diagram

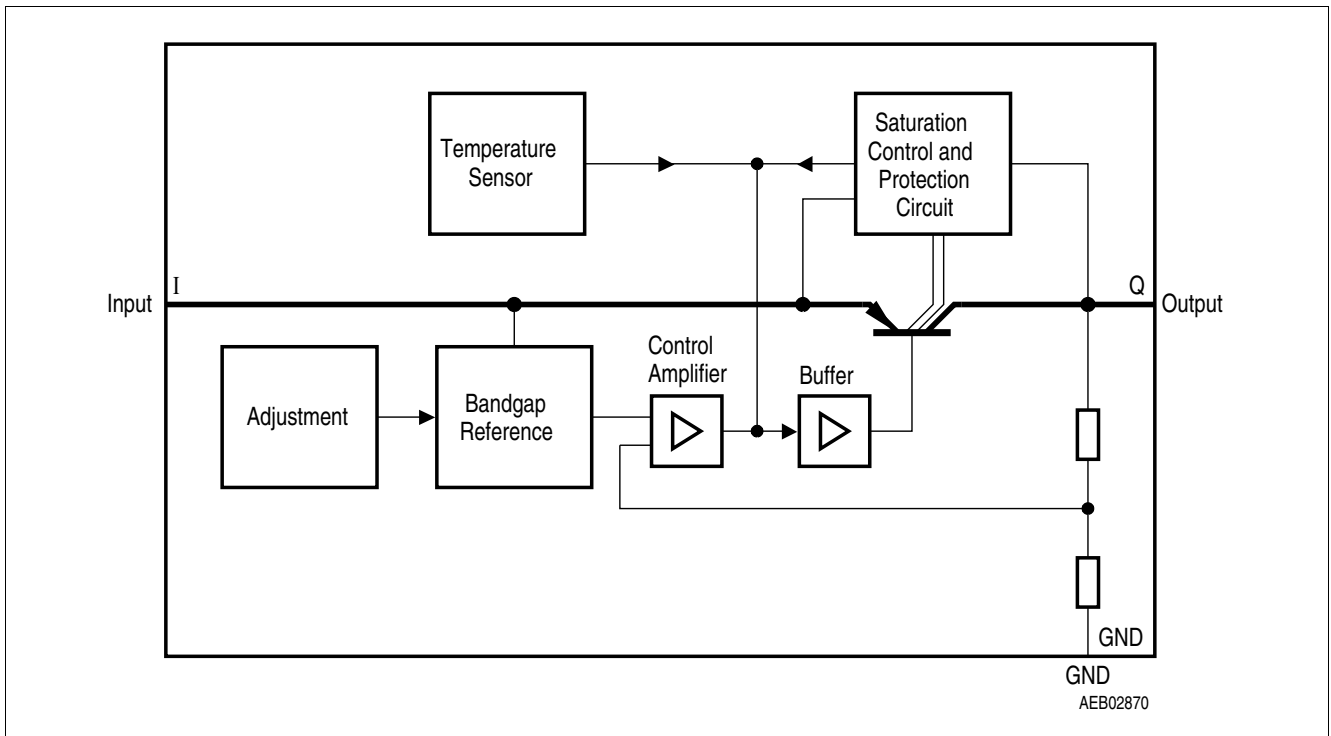

Figure 1 Block diagram

Pin configuration

2 Pin configuration

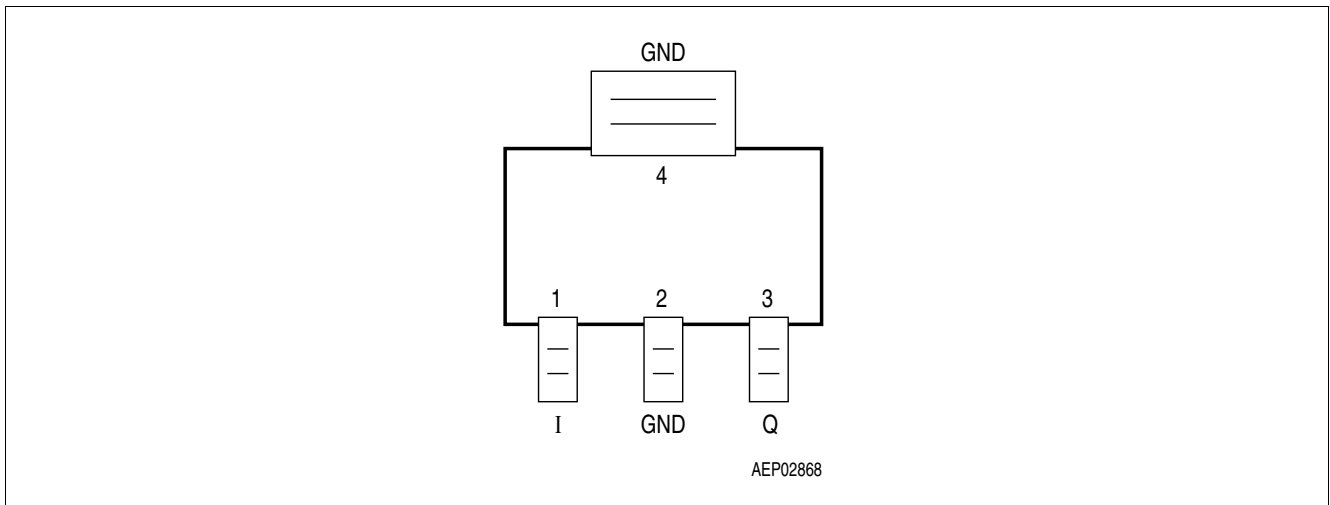

Figure 2 Pin configuration (top view)

Table 1 Pin definitions and functions

Pin	Symbol	Function
1	I	Input voltage Block to ground directly with a ceramic capacitor.
2, 4	GND	Ground
3	Q	5-V output voltage Block to ground with a capacitor $C_Q \geq 10 \mu\text{F}$, $\text{ESR} \leq 4 \Omega$.

General product characteristics

3 General product characteristics

3.1 Absolute maximum ratings

Table 2 Absolute maximum ratings

Parameter	Symbol	Values			Unit	Note or Test Condition
		Min.	Typ.	Max.		
Input I						
Input voltage	V_I	-42	–	45	V	–
Input current	I_I	–	–	–	–	Limited internally
Output Q						
Output voltage	V_Q	-0.3	–	32	V	–
Output current	I_Q	–	–	–	–	Limited internally
Ground GND						
Current	I_{GND}	50	–	–	mA	–
Temperature						
Junction temperature	T_j	–	–	150	°C	–
Storage temperature	T_{stg}	-50	–	150	°C	–
Thermal resistance						
Junction-ambient	R_{thj-a}	–	–	164	K/W	PG-SOT223-4 ¹⁾
	R_{thj-a}	–	–	81	K/W	PG-SOT223-4, 300 mm ² heat sink area
Junction-pin	R_{thj-p}	–	–	17	K/W	PG-SOT223-4 ²⁾
Operating range						
Input voltage	V_I	5.5	–	45	V	–
Junction temperature	T_j	-40	–	150	°C	–

1) Package mounted on PCB 80 × 80 × 1.5mm³; 35 μ Cu; 5 μ Sn; Footprint only; zero airflow.

2) Measured to pin 4.

General product characteristics

3.2 Electrical characteristics

Table 3 Electrical characteristics

$V_1 = 13.5 \text{ V}$; $T_j = -40^\circ\text{C}$ to 125°C , unless specified otherwise

Parameter	Symbol	Values			Unit	Note or Test Condition
		Min.	Typ.	Max.		
Output voltage	V_Q	4.85	5.0	5.15	V	$I_Q = 5 \text{ mA}$ to 100 mA $V_1 = 6 \text{ V}$ to 21 V
Output voltage	V_Q	4.9	5.0	5.1	V	$I_Q = 5 \text{ mA}$ to 50 mA $V_1 = 9 \text{ V}$ to 16 V
Output-current limiting	I_Q	150	200	500	mA	–
Current consumption $I_q = I_1 - I_Q$	I_q	–	40	60	μA	$I_Q = 100 \mu\text{A}$ $T_j \leq 85^\circ\text{C}$
	I_q	–	40	70	μA	$I_Q = 100 \mu\text{A}$
Current consumption $I_q = I_1 - I_Q$	I_q	–	1.7	4	mA	$I_Q = 50 \text{ mA}$
Drop voltage	V_{dr}	–	0.22	0.5	V	$I_Q = 100 \text{ mA}$ ¹⁾
Load regulation	$\Delta V_{Q, lo}$	–	50	90	mV	$I_Q = 1 \text{ mA}$ to 100 mA $V_1 = 13.5 \text{ V}$
Line regulation	$\Delta V_{Q, li}$	–	5	30	mV	$V_1 = 6 \text{ V}$ to 28 V $I_Q = 1 \text{ mA}$
Power supply ripple rejection	$PSRR$	–	68	–	dB	$f_r = 100 \text{ Hz}$ $V_r = 0.5 \text{ Vpp}$
Output capacitor	C_Q	10	–	–	μF	$ESR \leq 4 \Omega$ at 10 kHz

1) Drop voltage = $V_1 - V_Q$ (measured where V_Q has dropped 100 mV from the nominal value obtained at $V_1 = 13.5 \text{ V}$).

Functional description

4 Functional description

4.1 Application circuit

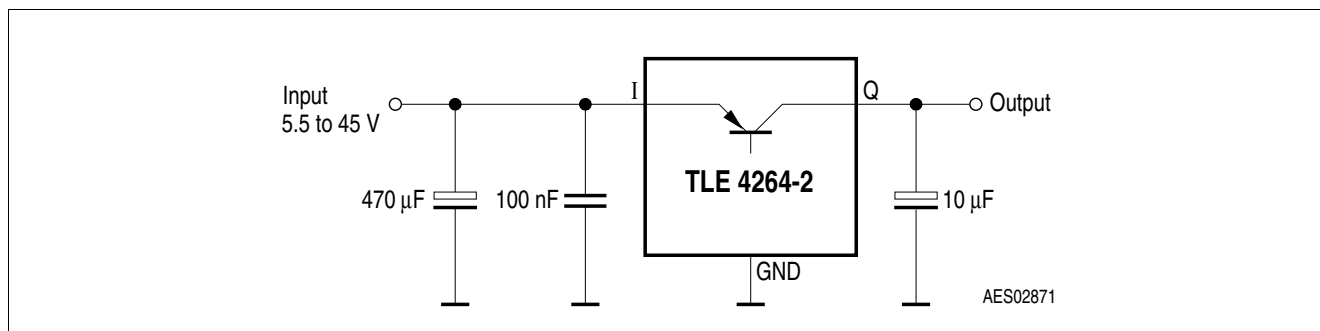

Figure 3 Application circuit

The control amplifier compares a reference voltage, which is kept highly precise by resistance adjustment, to a voltage that is proportional to the output voltage and drives the base of the series transistor via a buffer. Saturation control, working as a function of load current, prevents any over-saturation of the power element. The IC is additionally protected against overload, overtemperature and reverse polarity.

In the TLE4264-2 the output voltage is divided and compared to an internal reference of 2.5 V typical. The regulation loop controls the output to achieve an output voltage of 5 V with an accuracy of $\pm 3\%$ at an input voltage range of $5.5 \text{ V} < V_I < 45 \text{ V}$.

Figure 3 shows a typical application circuit. For stability of the control loop the TLE4264-2 output requires an output capacitor C_O of at least 10 μF with a maximum permissible ESR of 4 Ω . Tantalum as well as multi layer ceramic capacitors are suitable.

At the input of the regulator an input capacitor is necessary for compensating line influences (100 nF ceramic capacitor recommended). A resistor of approx. 1 Ω in series with C_I , can damp any oscillation occurring due the input inductivity and the input capacitor.

In the application circuit shown in **Figure 3** an additional electrolytic input capacitor of 470 μF is added in order to buffer supply line influences. This capacitor is recommended, if the device is sourced via long supply lines of several meters.

The TLE4264-2 can supply up to 150 mA. However for protection for high input voltage above 25 V, the output current is reduced (SOA protection).

Typical performance characteristics

5 Typical performance characteristics

Output voltage V_Q versus junction temperature T_j

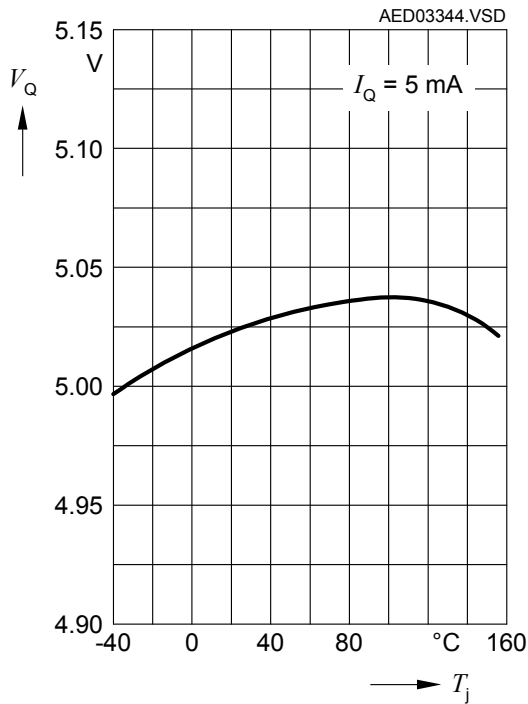

Drop voltage V_{dr} versus output current I_Q

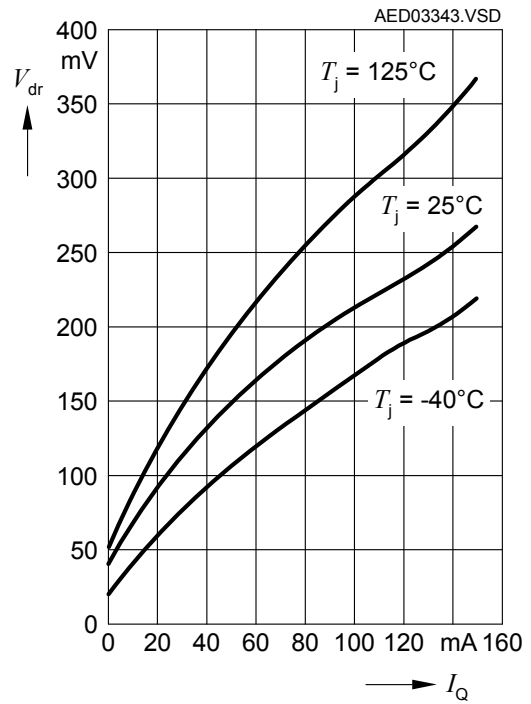

Output voltage V_Q versus input voltage V_I

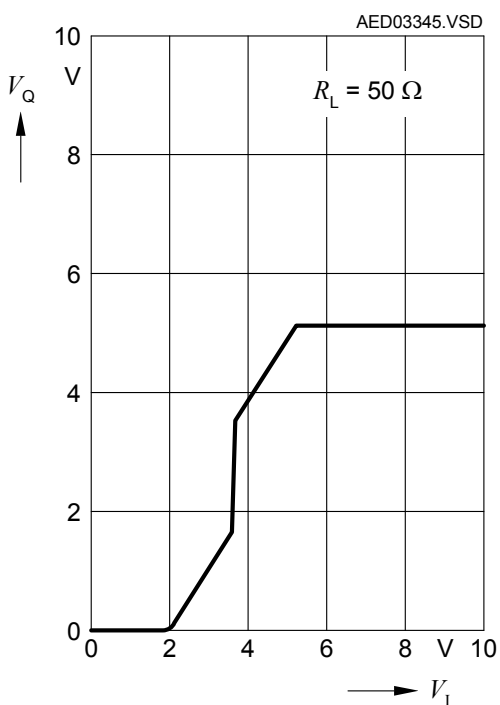

Typical performance characteristics

Current consumption I_q versus output current I_Q

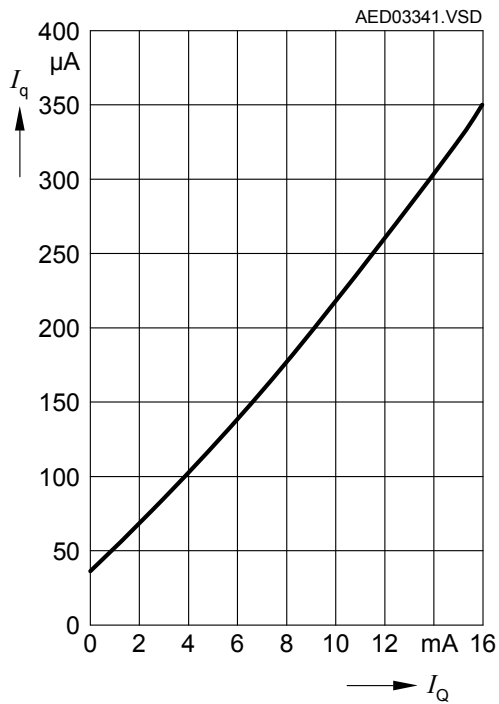

Current consumption I_q versus output current I_Q

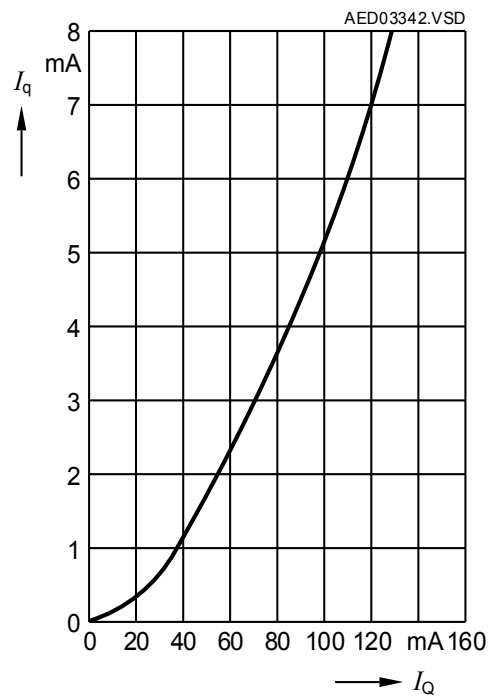

Revision history

7 Revision history

Revision	Date	Changes
2,71	2019-10-29	Editorial change on page 9
2.7	2019-05-22	Updated layout and structure Updated packaged drawing “PG-SOT223” Editorial changes
2.6	2008-03-10	Simplified package name to PG-SOT223-4 No modification of released product
2.5	2007-03-20	Initial version of RoHS-compliant derivate of TLE 4264-2 Page 1: AEC certified statement added Page 1 and Page 10: RoHS compliance statement and Green product feature added Page 1 and Page 10: Package changed to RoHS compliant version Legal Disclaimer updated

Trademarks

All referenced product or service names and trademarks are the property of their respective owners.

Edition 2019-10-29

Published by

Infineon Technologies AG

81726 Munich, Germany

© 2019 Infineon Technologies AG.

All Rights Reserved.

Do you have a question about any aspect of this document?

Email: erratum@infineon.com

Document reference

Z8F55276373

IMPORTANT NOTICE

The information given in this document shall in no event be regarded as a guarantee of conditions or characteristics ("Beschaffheitsgarantie").

With respect to any examples, hints or any typical values stated herein and/or any information regarding the application of the product, Infineon Technologies hereby disclaims any and all warranties and liabilities of any kind, including without limitation warranties of non-infringement of intellectual property rights of any third party.

In addition, any information given in this document is subject to customer's compliance with its obligations stated in this document and any applicable legal requirements, norms and standards concerning customer's products and any use of the product of Infineon Technologies in customer's applications.

The data contained in this document is exclusively intended for technically trained staff. It is the responsibility of customer's technical departments to evaluate the suitability of the product for the intended application and the completeness of the product information given in this document with respect to such application.

For further information on technology, delivery terms and conditions and prices, please contact the nearest Infineon Technologies Office (www.infineon.com).

WARNINGS

Due to technical requirements products may contain dangerous substances. For information on the types in question please contact your nearest Infineon Technologies office.

Except as otherwise explicitly approved by Infineon Technologies in a written document signed by authorized representatives of Infineon Technologies, Infineon Technologies' products may not be used in any applications where a failure of the product or any consequences of the use thereof can reasonably be expected to result in personal injury.

X-ON Electronics

Largest Supplier of Electrical and Electronic Components

Click to view similar products for [LDO Voltage Regulators](#) category:

Click to view products by [Infineon](#) manufacturer:

Other Similar products are found below :

[AP7363-SP-13](#) [L79M05TL-E](#) [PT7M8202B12TA5EX](#) [TCR3DF185,LM\(CT](#) [MP2013GQ-33-Z](#) [059985X](#) [NCP4687DH15T1G](#) [701326R](#)
[TCR2EN28,LF\(S](#) [NCV8170AXV250T2G](#) [TCR2EN18,LF\(S](#) [AP7315-25W5-7](#) [IFX30081LDVGRNXUMA1](#) [NCV47411PAAJR2G](#)
[AP2113KTR-G1](#) [AP2111H-1.2TRG1](#) [ZLDO1117QK50TC](#) [AZ1117IH-1.8TRG1](#) [TCR3DG12,LF](#) [MIC5514-3.3YMT-T5](#) [MIC5512-1.2YMT-](#)
[T5](#) [MIC5317-2.8YM5-T5](#) [SCD7912BTG](#) [NCP154MX180270TAG](#) [SCD33269T-5.0G](#) [NCV8170BMX330TCG](#) [NCV8170AMX120TCG](#)
[NCP706ABMX300TAG](#) [NCP153MX330180TCG](#) [NCP114BMX075TCG](#) [MC33269T-3.5G](#) [CAT6243-ADJCMT5T](#) [TCR3DG33,LF](#)
[AP2127N-1.0TRG1](#) [TCR4DG35,LF](#) [LT1117CST-3.3](#) [LT1117CST-5](#) [TAR5S15U\(TE85L,F\)](#) [TAR5S18U\(TE85L,F\)](#) [TCR3UG19A,LF](#)
[TCR4DG105,LF](#) [NCV8170AMX360TCG](#) [MIC94310-NYMT-T5](#) [TLE4268GSXUMA2](#) [NCV8186BMN175TAG](#) [NCP715SQ15T2G](#)
[MIC5317-3.0YD5-T5](#) [NCV563SQ18T1G](#) [MIC5317-2.8YD5-T5](#) [NCP715MX30TBG](#)