

TLE4946K

High Precision Bipolar Hall-Effect Latch

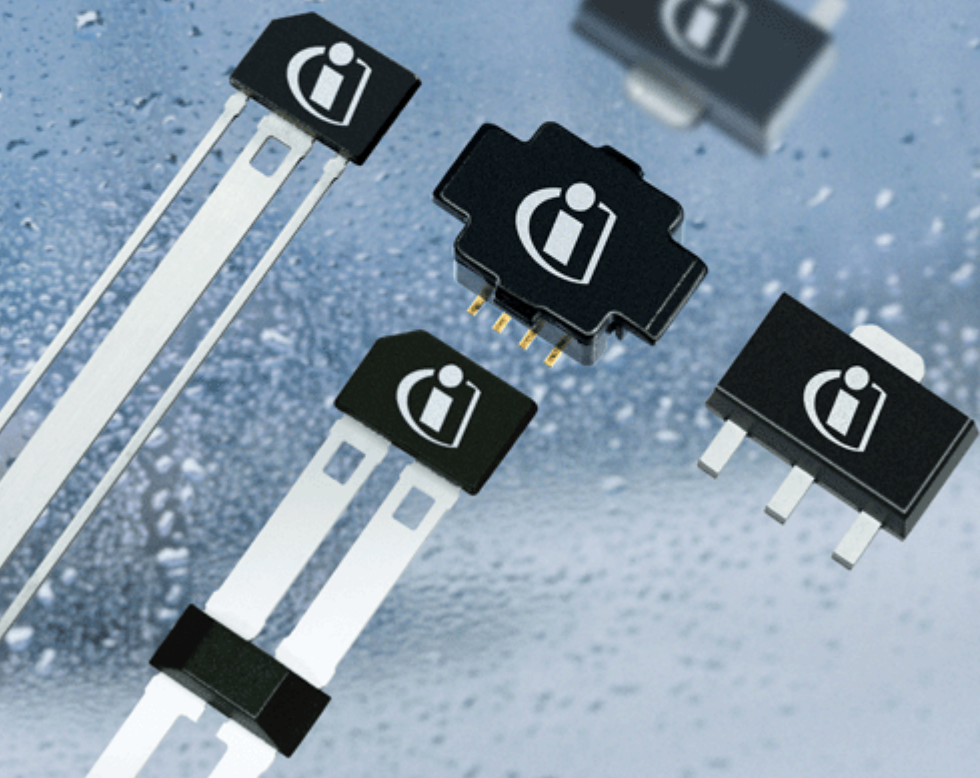

Sensors

Edition 2007-09

**Published by
Infineon Technologies AG
81726 München, Germany
© 2007 Infineon Technologies AG
All Rights Reserved.**

Legal Disclaimer

The information given in this document shall in no event be regarded as a guarantee of conditions or characteristics. With respect to any examples or hints given herein, any typical values stated herein and/or any information regarding the application of the device, Infineon Technologies hereby disclaims any and all warranties and liabilities of any kind, including without limitation, warranties of non-infringement of intellectual property rights of any third party.

Information

For further information on technology, delivery terms and conditions and prices, please contact the nearest Infineon Technologies Office (www.infineon.com).

Warnings

Due to technical requirements, components may contain dangerous substances. For information on the types in question, please contact the nearest Infineon Technologies Office.

Infineon Technologies components may be used in life-support devices or systems only with the express written approval of Infineon Technologies, if a failure of such components can reasonably be expected to cause the failure of that life-support device or system or to affect the safety or effectiveness of that device or system. Life support devices or systems are intended to be implanted in the human body or to support and/or maintain and sustain and/or protect human life. If they fail, it is reasonable to assume that the health of the user or other persons may be endangered.

Previous Version:

| Page | Subjects (major changes since last revision) |
|------|--|
| | |
| | |
| | |
| | |
| | |

We Listen to Your Comments

Any information within this document that you feel is wrong, unclear or missing at all? Your feedback will help us to continuously improve the quality of this document.

Please send your proposal (including a reference to this document) to:

sensors@infineon.com



| | | |
|----------|---|----------|
| 1 | Overview | 1 |
| 1.1 | Features | 1 |
| 1.2 | Functional Description | 1 |
| 1.3 | Pin Configuration (top view) | 2 |
| 2 | General | 3 |
| 2.1 | Block Diagram | 3 |
| 2.2 | Circuit Description | 3 |
| 3 | Maximum Ratings | 4 |
| 4 | Operating Range | 5 |
| 5 | Electrical and Magnetic Parameters | 6 |
| 6 | Timing Diagram | 8 |
| 7 | Package Information | 9 |
| 7.1 | Package Marking | 9 |
| 7.2 | Distance between Chip and Package Surface | 10 |
| 7.3 | Package Outlines | 10 |

1 Overview

1.1 Features

- 2.7 V to 24 V supply voltage operation
- Operation from unregulated power supply
- High sensitivity and high stability of the magnetic switching points
- High resistance to mechanical stress by Active Error Compensation
- Reverse battery protection (– 18 V)
- Superior temperature stability
- Peak temperatures up to 195°C without damage
- Low jitter (typ. 1 μ s)
- High ESD performance (\pm 6 kV HBM)
- Digital output signal
- SMD package SC59 (SOT23 compatible)

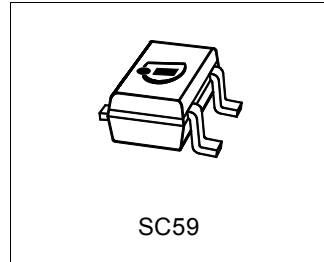

1.2 Functional Description

The TLE4946K is an integrated circuit Hall-effect sensor designed specifically for highly accurate applications.

Precise magnetic switching points and high temperature stability are achieved by active compensation circuits and chopper techniques on chip.

| Type | Package |
|----------|---------|
| TLE4946K | SC59 |

1.3 Pin Configuration (top view)

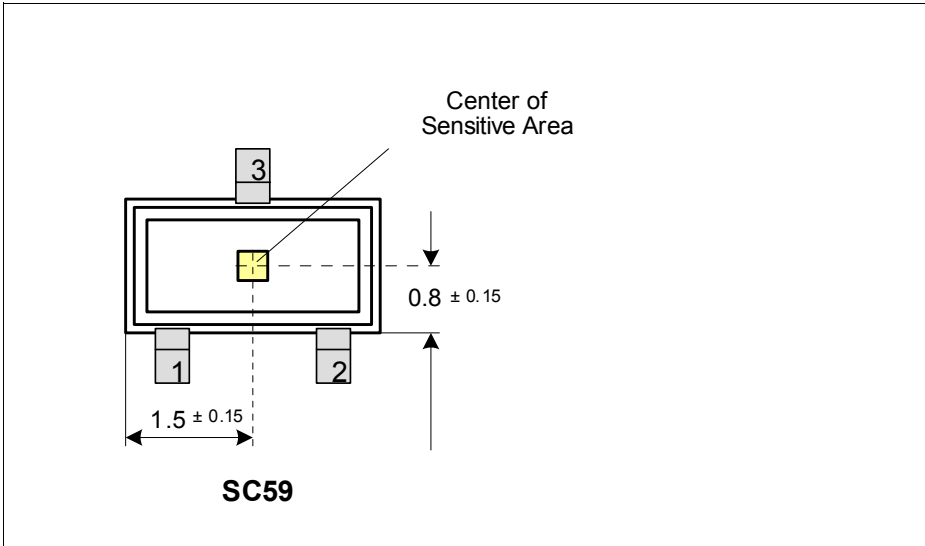

Figure 1 Pin Definition and Center of Sensitive Area

Table 1 Pin Definitions and Functions SC59

| Pin No. | Symbol | Function |
|---------|--------|----------------|
| 1 | V_S | Supply voltage |
| 2 | Q | Output |
| 3 | GND | Ground |

2 General

2.1 Block Diagram

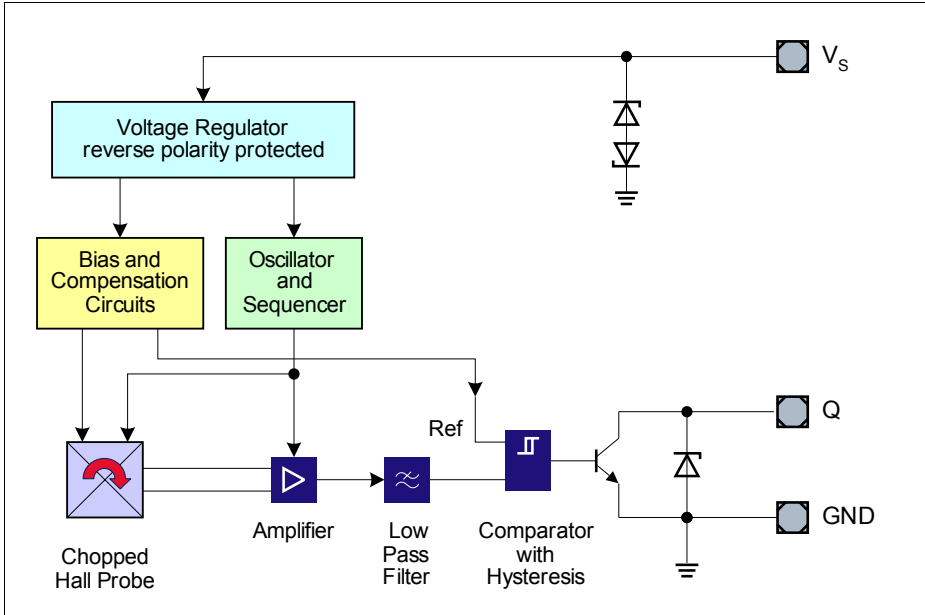

Figure 2 Block Diagram

2.2 Circuit Description

The chopped Hall IC Switch comprises a Hall probe, bias generator, compensation circuits, oscillator, and output transistor.

The bias generator provides currents for the Hall probe and the active circuits. Compensation circuits stabilize the temperature behavior and reduce technology variations.

The Active Error Compensation rejects offsets in signal stages and the influence of mechanical stress to the Hall probe caused by molding and soldering processes and other thermal stresses in the package.

This chopper technique together with the threshold generator and the comparator ensure high accurate magnetic switching points.

Maximum Ratings

3 Maximum Ratings

Table 2 Absolute Maximum Ratings
 $T_j = -40^{\circ}\text{C to } 150^{\circ}\text{C}$

| Parameter | Symbol | Limit Values | | Unit | Conditions |
|--|--------|----------------------|--------------------------|--------------------|--|
| | | min. | max. | | |
| Supply voltage | V_S | - 18 - 18 - 18 | 18 24 26 | V | for 1 h, $R_s \geq 200 \Omega$ for 5 min, $R_s \geq 200 \Omega$ |
| Supply current through protection device | I_S | - 50 | + 50 | mA | |
| Output voltage | V_Q | - 0.7 - 0.7 | 18 26 | V | for 5 min @ 1.2 k Ω pull up |
| Continuous output current | I_Q | - 50 | + 50 | mA | |
| Junction temperature | T_j | - - - - | 155 165 175 195 | $^{\circ}\text{C}$ | for 2000 h (not additive) for 1000 h (not additive) for 168 h (not additive) for 3 x 1 h (additive) |
| Storage temperature | T_S | - 40 | 150 | $^{\circ}\text{C}$ | |
| Magnetic flux density | B | - | unlimited | mT | |

Note: Stresses above those listed here may cause permanent damage to the device. Exposure to absolute maximum rating conditions for extended periods may affect device reliability.

Table 3 ESD Protection ¹⁾

| Parameter | Symbol | Limit Values | | Unit | Notes |
|-------------|------------------|--------------|---------|------|--|
| | | min. | max. | | |
| ESD voltage | V_{ESD} | - | ± 6 | kV | HBM, $R = 1.5 \text{ k}\Omega$, $C = 100 \text{ pF}$ $T_A = 25^{\circ}\text{C}$ |

¹⁾ Human Body Model (HBM) tests according to: EOS/ESD Association Standard S5.1-1993 and Mil. Std. 883D method 3015.7

4 Operating Range

Table 4 Operating Range

| Parameter | Symbol | Limit Values | | | Unit | Conditions |
|----------------------|--------|--------------|------|------|------|------------|
| | | min. | typ. | max. | | |
| Supply voltage | V_S | 2.7 | – | 18 | V | |
| Output voltage | V_Q | – 0.7 | – | 18 | V | |
| Junction temperature | T_j | – 40 | – | 150 | °C | |
| Output current | I_Q | 0 | – | 20 | mA | |

Electrical and Magnetic Parameters
5 Electrical and Magnetic Parameters
Table 5 Electrical Characteristics ¹⁾.

| Parameter | Symbol | Limit Values | | | Unit | Conditions |
|----------------------------------|-------------|--------------|------|------------------|---------------------|---|
| | | min. | typ. | max. | | |
| Supply current | I_S | 2 | 4 | 6 | mA | $V_S = 2.7 \text{ V} \dots 18 \text{ V}$ |
| Reverse current | I_{SR} | 0 | 0.2 | 1 | mA | $V_S = -18 \text{ V}$ |
| Output saturation voltage | V_{QSAT} | – | 0.3 | 0.6 | V | $I_Q = 20 \text{ mA}$ |
| Output leakage current | I_{QLEAK} | – | 0.05 | 10 | μA | for $V_Q = 18 \text{ V}$ |
| Output fall time | t_f | – | 0.02 | 1 | μs | $R_L = 1.2 \text{ k}\Omega$; $C_L = 50 \text{ pF}$ see: Figure 3 “Timing Definition” on Page 9 |
| Output rise time | t_r | – | 0.4 | 1 | μs | |
| Chopper frequency | f_{OSC} | – | 320 | – | kHz | |
| Switching frequency | f_{SW} | 0 | – | 15 ²⁾ | kHz | |
| Delay time ³⁾ | t_d | – | 13 | – | μs | |
| Output jitter ⁴⁾ | t_{QJ} | – | 1 | – | μs_{RMS} | Typical value for square wave signal 1 kHz |
| Power-on time ⁵⁾ | t_{PON} | – | 13 | – | μs | $V_S \geq 2.7 \text{ V}$ |
| Thermal resistance ⁶⁾ | R_{thJA} | – | 100 | – | K/W | SC59 |

1) over operating range, unless otherwise specified. Typical values correspond to $V_S = 12 \text{ V}$ and $T_A = 25^\circ\text{C}$

2) To operate the sensor at the max. switching frequency, the value of the magnetic signal amplitude must be 1.4 times higher than for static fields.

This is due to the -3 dB corner frequency of the low pass filter in the signal path.

3) Systematic delay between magnetic threshold reached and output switching

4) Jitter is the unpredictable deviation of the output switching delay

5) Time from applying $V_S \geq 2.7 \text{ V}$ to the sensor until the output state is valid

6) Thermal resistance from junction to ambient

Calculation of the ambient temperature (SC59 example)

e.g. for $V_S = 12.0 \text{ V}$, $I_{Styp} = 4 \text{ mA}$, $V_{QSATtyp} = 0.3 \text{ V}$ and $I_Q = 20 \text{ mA}$:

Power Dissipation: $P_{DIS} = 54.0 \text{ mW}$.

In $T_A = T_j - (R_{thJA} \times P_{DIS}) = 175^\circ\text{C} - (100 \text{ K/W} \times 0.054 \text{ W})$

Resulting max. ambient temperature: $T_A = 169.6^\circ\text{C}$

Note: Typical characteristics specify mean values expected over the production spread.

Electrical and Magnetic Parameters
Table 6 Magnetic Characteristics TLE4946K ¹⁾

| Parameter | Symbol | T_j [°C] | Limit Values | | | Unit | Notes |
|--|-----------|------------|--------------|--------|--------|---------------|---|
| | | | min. | typ. | max. | | |
| Operate point | B_{OP} | - 40 | 11.8 | 15.8 | 19.2 | mT | |
| | | 25 | 11.0 | 14.0 | 17.0 | | |
| | | 150 | 6.1 | 9.6 | 13.7 | | |
| Release point | B_{RP} | - 40 | - 19.2 | - 15.8 | - 11.8 | mT | |
| | | 25 | - 17.0 | - 14.0 | - 11.0 | | |
| | | 150 | - 13.7 | - 9.6 | - 6.1 | | |
| Hysteresis | B_{HYS} | - 40 | - | - | - | mT | |
| | | 25 | 22.0 | 28.0 | 34.0 | | |
| | | 150 | - | - | - | | |
| Magnetic Offset | B_{OFF} | - 40 | - | - | - | mT | ²⁾ |
| | | 25 | - 3.0 | - | 3.0 | | |
| | | 150 | - | - | - | | |
| Temperature compensation of magn. thresholds | TC | - | - | - 2000 | - | ppm/°C | |
| Repeatability of magnetic thresholds ³⁾ | B_{REP} | | - | 20 | - | μT_{RMS} | Typ. value for $\Delta B / \Delta t > 12$ mT/ms |

1) over operating range, unless otherwise specified. Typical values correspond to $V_S = 12$ V.

2) $B_{OFF} = (B_{OP} + B_{RP}) / 2$

3) B_{REP} is equivalent to the noise constant

Field Direction Definition

Positive magnetic fields related with south pole of magnet to the branded side of package.

6 Timing Diagram

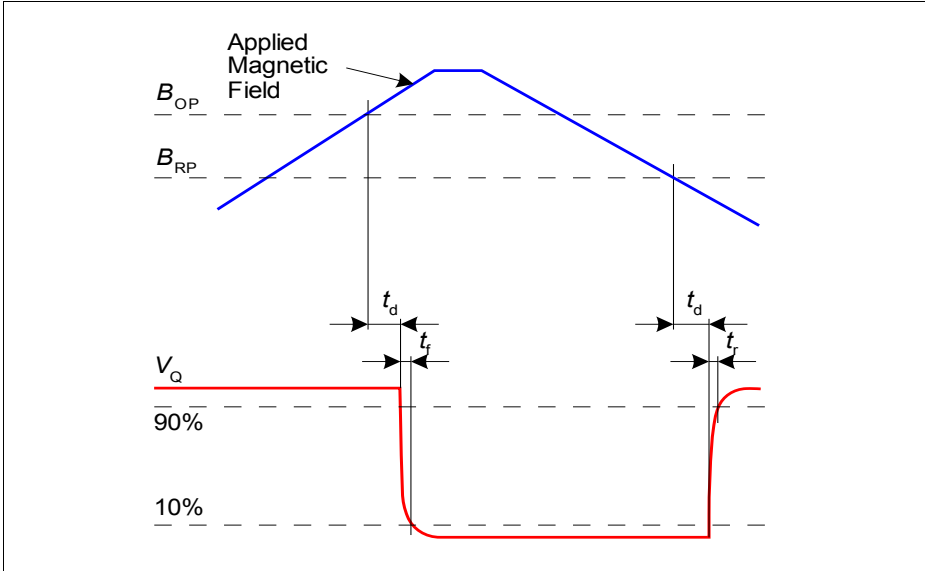

Figure 3 Timing Definition

7 Package Information

7.1 Package Marking

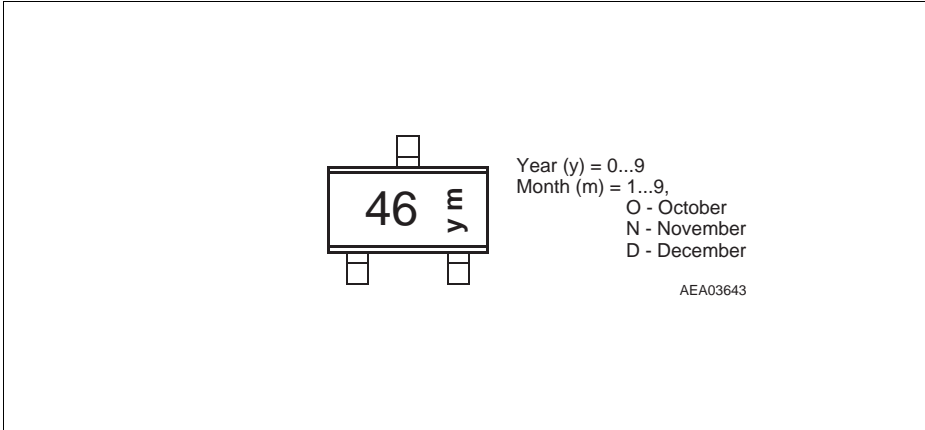

Figure 4 Marking TLE4946K

PCB Footprint for SC59

The following picture shows a recommendation for the PCB layout.

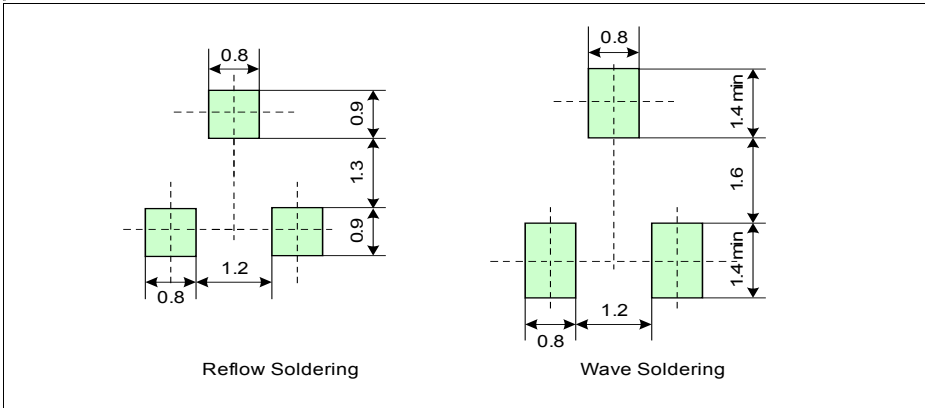

Figure 7 Footprint SC59 (SOT23 compatible)

Note: You can find all of our packages, sorts of packing and others in our Infineon Internet Page "Products": <http://www.infineon.com/products>.

Dimensions in mm

www.infineon.com

Published by Infineon Technologies AG

X-ON Electronics

Largest Supplier of Electrical and Electronic Components

Click to view similar products for [Board Mount Hall Effect/Magnetic Sensors](#) category:

Click to view products by [Infineon](#) manufacturer:

Other Similar products are found below :

[HGPRDT005A](#) [AH1808-P-A](#) [AH277AZ4-AG1](#) [AV-10379](#) [AV-10448](#) [SS41C](#) [AH1894-Z-7](#) [ATS601LSGTN-HT-WU4-T](#) [ATS601LSGTN-LT-WU4-T](#) [TLE4917](#) [50017859-003](#) [TY-13101](#) [SS85CA](#) [AH277AZ4-BG1](#) [TLE49614MXTSA1](#) [AH3382-P-B](#) [AH3377-P-B](#) [AH9250-W-7](#) [AH211Z4-AG1](#) [AH3360-FT4-7](#) [SS460S-100SAMPLE](#) [50065820-03](#) [TLE4941PLUSCB](#) [AH374-P-A](#) [AH1806-P-A](#) [AH374-W-7](#) [SS460P-T2](#) [AH1912-FA-7](#) [SS413F](#) [TLE5046ICAKLRHALA1](#) [TLE49421CHAMA2](#) [TLE4941PLUSCXAMA1](#) [AH1912-W-EVM](#) [AH1903-FA-EVM](#) [AH3774-W-EVM](#) [AH49FNTR-EVM](#) [MMC5633NJL](#) [AH3360-FA-EVM](#) [AH8502-FDC-EVM](#) [AH3366Q-SA-EVM](#) [AH3774-P-EVM](#) [KTH1601SU-ST3](#) [MG910](#) [MG910M](#) [MG911](#) [MG610](#) [MW921](#) [MW922](#) [TLE4998S3XALA1](#) [TLE5011FUMA1](#)