

TLE5x09A16(D)

Analog AMR/GMR Angle Sensors



RoHS



ISO 26262
ready

Features

- Single and dual die sensor with AMR or GMR technology
- Separate supply pins for top and bottom sensor
- Low current consumption and quick start up
- 180°(AMR) and 360°(GMR) contactless angle measurement
- Output amplitude optimized for circuits with 3.3 V or 5 V supply voltage
- Immune to airgap variations due to MR based sensing principle
- Automotive qualified Q100, Grade 1: -40°C to 125°C (ambient temperature)
- Pre-amplified output signals for differential or single-ended applications
- Diverse redundance combination of GMR sensor and AMR sensor in one package possible
- High accuracy typically 0.1° overall angle error for AMR sensor
- Green product (RoHS compliant)

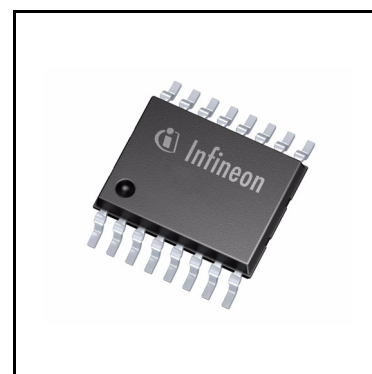

Functional Safety

Safety Manual and Safety Analysis Summary Report available on request.

Product Validation

Developed for automotive applications. Product qualification according to AEC-Q100.

Potential Applications

The TLE5x0916(D) angle sensors are designed for angular position sensing in safety critical automotive and non- automotive applications. Their high accuracy combined with short propagation delay make especially the GMR sensor variants suitable for systems with high speeds and high accuracy demands such as brush-less DC (BLDC) motors for actuators and electric power steering systems (EPS). The AMR sensor variants with their typically accuracy of 0.1° fit for systems with high speeds and high accuracy demands such as pedals, levers or brush-less DC (BLDC) motors with an even number of pole pairs. At the same time their fast start-up time and low overall power consumption enables the device to be employed for low-power turn counting. Extremely low power consumption can be achieved with power cycling, where the advantage of fast power on time reduces the average power consumption. Potential applications are:

- BLDC motors
- Pedals and rotary switches
- Steering angle sensing
- Valve or flap position sensing

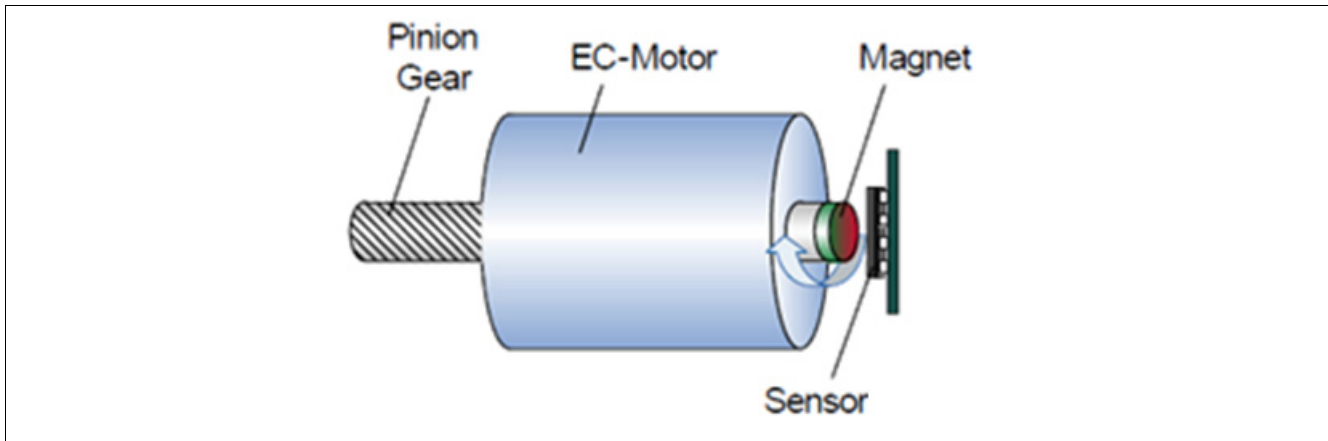

Figure 1 A usual application for TLE5x09A16(D) is the electrically commutated motor

Description

The TLE5x0916(D) are angle sensor with analog outputs. They detect the orientation of a magnetic field by measuring sine and cosine angle components with **Magneto Resistive (MR)** elements. The sensors provide analog sine and cosine output voltages that describe the magnetic angle in a range of 0 to 180° (AMR sensor), and 0 to 360° (GMR sensor), respectively. There are single die and dual die combinations with a **Giant Magneto Resistance (GMR)** sensor for full 360° angle range or also an **Anisotropic Magneto Resistance (AMR)** sensor for high precision in a top-bottom configuration in one package possible. The following derivatives of the TLE5x09A16(D) sensor family are available:

- Single die GMR: TLE5009A16
- Dual die GMR: TLE5009A16D
- Single die AMR: TLE5109A16
- Dual die AMR: TLE5109A16D
- Dual die AMR (bottom) / GMR (top): TLE5309D

The differential MR bridge signals are independent of the magnetic field strength to maintain constant output voltage over a wide temperature and field range. The analog output is designed for differential or single-ended applications and an internal temperature compensation is applied for higher accuracy.

The sensor is available as single die version (TLE5x09A16) and dual die version (TLE5x09A16D) for safety applications that require redundancy. The two versions are pin-compatible for easy scalability. In the dual die TLE5x09A16D, both sensor dies are supplied independently by separate supply and ground pins.

Table 1 TLE5009A16(D) Derivate ordering codes

Product Type	Marking	Ordering Code	Package	Description
TLE5009A16 E1200	09A11200	SP001285624	PG-TDSO-16	3.3 V, single die, without TCO ¹⁾
TLE5009A16 E1210	09A11210	SP001296110	PG-TDSO-16	3.3 V, single die, with TCO ¹⁾
TLE5009A16 E2200	09A12200	SP001296118	PG-TDSO-16	5.0 V, single die, without TCO ¹⁾
TLE5009A16 E2210	09A12210	SP001296114	PG-TDSO-16	5.0 V, single die, with TCO ¹⁾
TLE5009A16D E1200	09A21200	SP001285628	PG-TDSO-16	3.3 V, dual die, without TCO ¹⁾
TLE5009A16D E1210	09A21210	SP001296122	PG-TDSO-16	3.3 V, dual die, with TCO ¹⁾

Table 1 TLE5009A16(D) Derivate ordering codes (cont'd)

Product Type	Marking	Ordering Code	Package	Description
TLE5009A16D E2200	09A22200	SP001296126	PG-TDSO-16	5.0 V, dual die, without TCO ¹⁾
TLE5009A16D E2210	09A22210	SP001296130	PG-TDSO-16	5.0 V, dual die, with TCO ¹⁾

1) Temperature Compensation Offset.

Table 2 TLE5109A16(D) Derivate ordering codes

Product Type	Marking	Ordering Code	Package	Description
TLE5109A16 E1210	10911210	SP000956970	PG-TDSO-16	3.3 V, single die, with TCO ¹⁾
TLE5109A16 E2210	10912210	SP000956966	PG-TDSO-16	5.0 V, single die, with TCO ¹⁾
TLE5109A16D E1210	10921210	SP001496434	PG-TDSO-16	3.3 V, dual die, with TCO ¹⁾
TLE5109A16D E2210	10922210	SP001044230	PG-TDSO-16	5.0 V, dual die, with TCO ¹⁾

1) Temperature Compensation Offset.

Table 3 TLE5309D Derivate ordering codes

Product Type	Marking	Ordering Code	Package	Description
TLE5309D E1211	309D1211	SP001227880	PG-TDSO-16	3.3 V, dual die, AMR (bottom) and GMR (top), with TCO ¹⁾
TLE5309D E2211	309D2211	SP001227888	PG-TDSO-16	5.0 V, dual die, AMR(bottom) and GMR (top), with TCO ¹⁾
TLE5309D E5201	309D5201	SP001227884	PG-TDSO-16	5.0 V AMR (bottom), 3.3 V GMR (top), dual die, without TCO ¹⁾

1) Temperature Compensation Offset.

Table of Contents

	Features	1
	Functional Safety	1
	Product Validation	1
	Potential Applications	1
	Description	2
	Table of Contents	4
1	Functional description	5
1.1	General	5
1.2	Pin configuration	8
1.3	Pin description	8
1.4	Block diagram	9
1.5	Dual die angle output	10
2	Specification	12
2.1	Application circuit	12
2.2	Absolute maximum ratings	16
2.3	Sensor specification	17
2.3.1	Operating range	17
2.3.2	Electrical parameters	18
2.3.3	Output parameters	18
2.4	Error diagnosis	23
2.5	Angle performance	23
2.6	Electrostatic discharge protection	26
2.7	Electro magnetic compatibility (EMC)	26
3	Package information	27
3.1	Package parameters	27
3.2	Package outlines	27
3.3	Footprint	29
3.4	Packing	29
3.5	Marking	30
4	Revision history	31

Functional description

1 Functional description

1.1 General

The Magneto Resistive (MR) sensors are implemented using vertical integration. This means that the MR sensitive areas are integrated above the analog portion of the ICs. These MR elements change their resistance depending on the direction of the magnetic field.

On each sensor, four individual MR elements are connected in a Wheatstone bridge arrangement. Each MR element senses one of two components of the applied magnetic field:

- X component, V_x (cosine) or the
- Y component, V_y (sine)

The advantage of a full-bridge structure is that the amplitude of the MR signal is doubled and temperature effects cancel out.

GMR Sensor

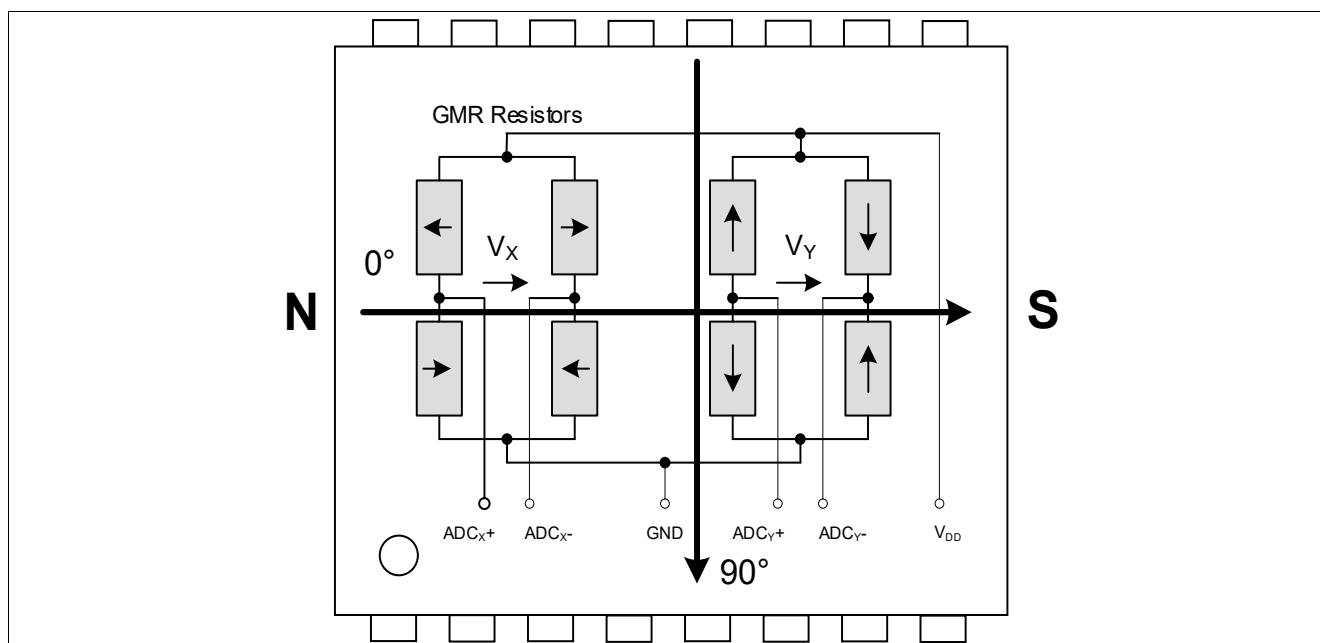

Figure 2 Sensitive bridges of the GMR sensor

Note: In **Figure 2**, the arrows in the resistors symbolize the direction of the reference layer. The size of the sensitive areas is greatly exaggerated for better visualization.

With the trigonometric function ARCTAN2, the true 360° angle value that is represented by the relation of X and Y signals can be calculated according to **Equation (1)**.

$$\alpha = \arctan2(V_x, V_y) \tag{1}$$

The ARCTAN2 function is a microcontroller library function which resolves an angle within 360° using the x and y coordinates on a unit circle.

Functional description

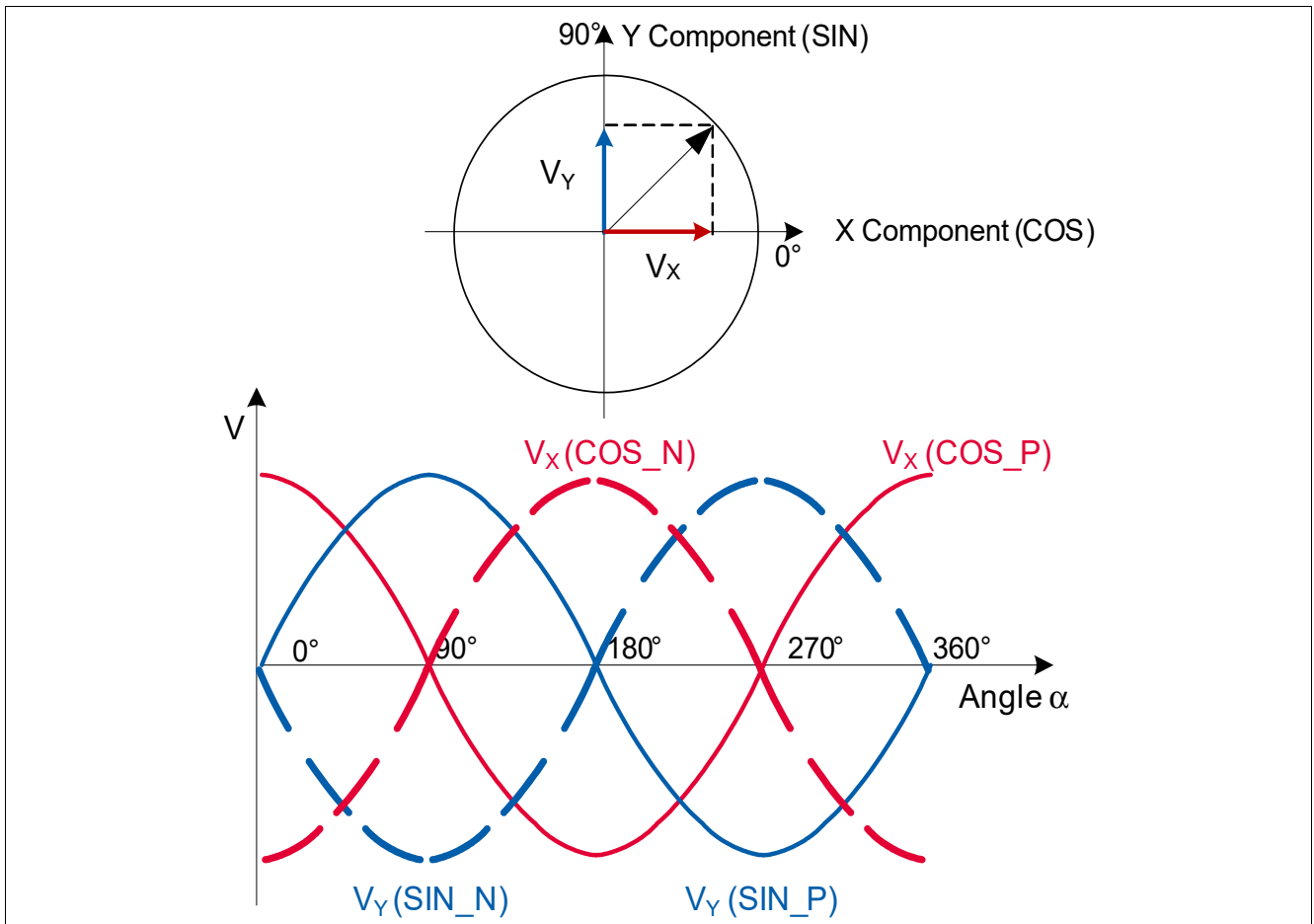

Figure 3 Ideal output of the GMR sensor bridges

Functional description

AMR sensor

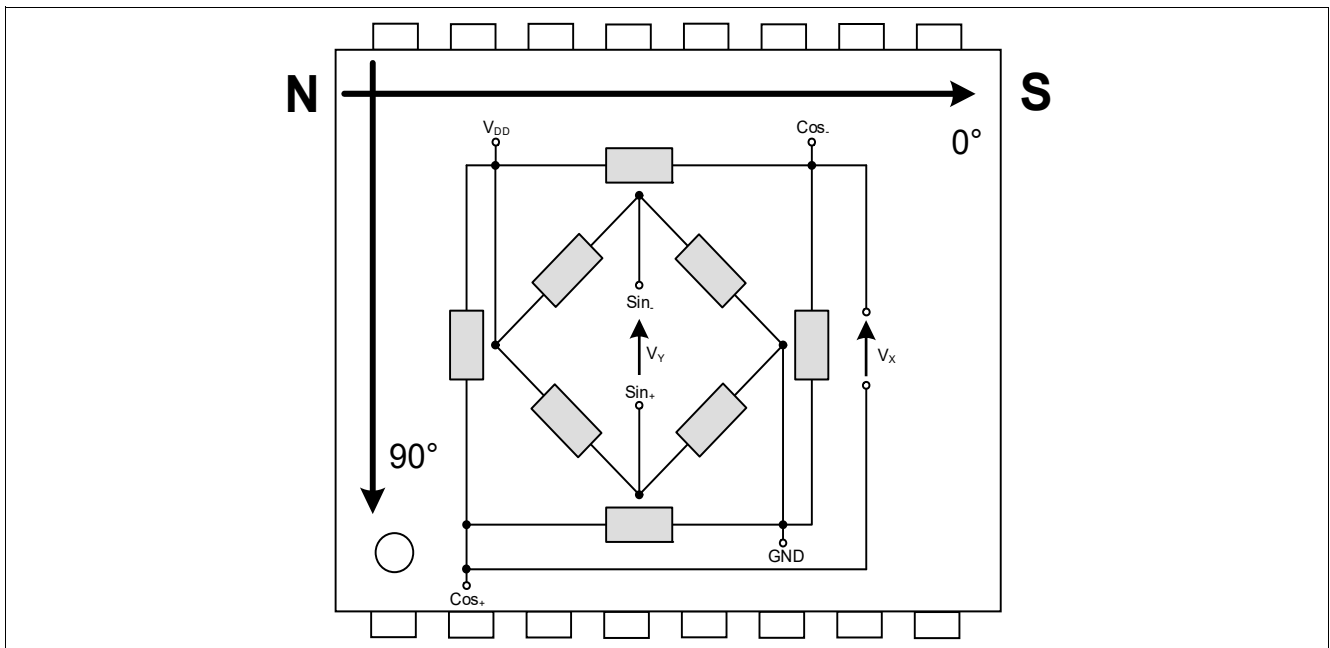

Figure 4 Sensitive bridges of the AMR sensor

Note: In Figure 4, the size of the sensitive areas is greatly exaggerated for better visualization.

With the trigonometric function ARCTAN2, the true 180° angle value that is represented by the relation of X and Y signals can be calculated according to Equation (2). The AMR sensing element internally measures the double angle, so the result has to be divided by 2. At external magnetic angles α between 180° and 360°, the angle measured by the sensor is $\alpha - 180^\circ$.

$$\alpha = \arctan2(V_x, V_y) / 2 \tag{2}$$

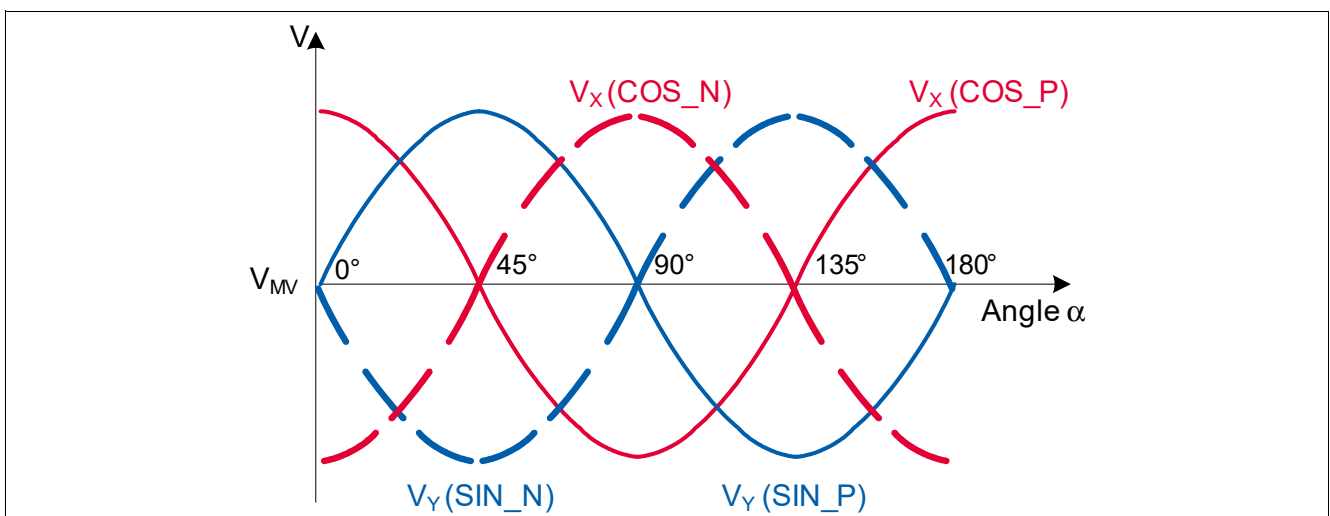

Figure 5 Ideal output of the AMR sensor bridges

Functional description

1.2 Pin configuration

The sensitive area is located at the center of the chip.

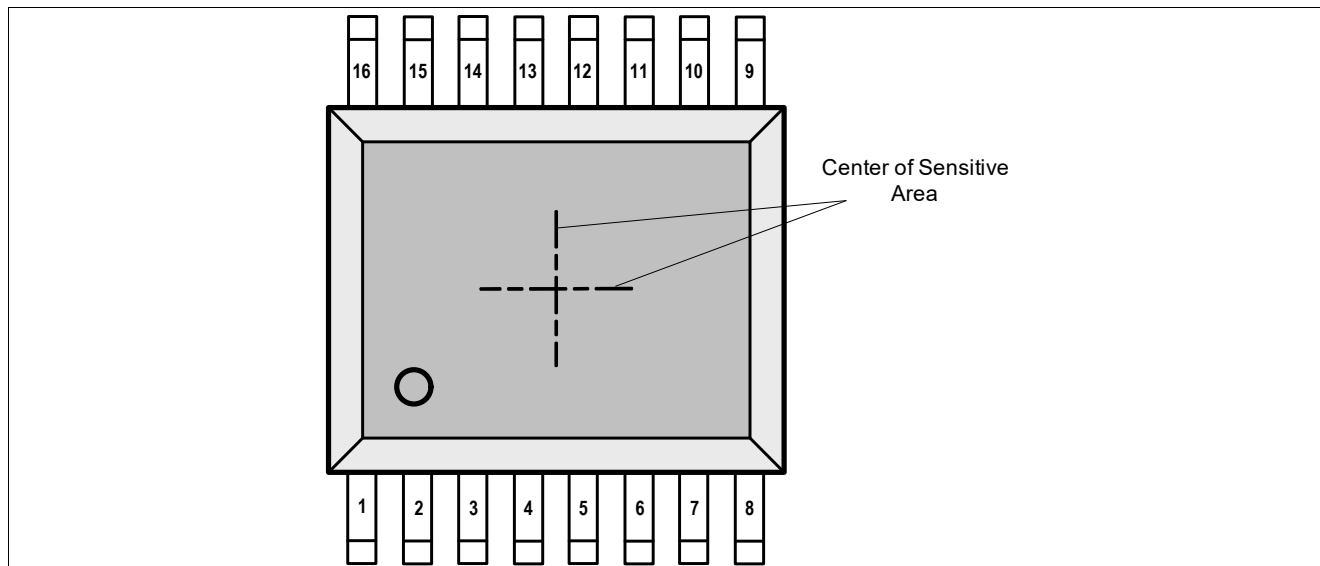

Figure 6 Pin configuration (top view)

1.3 Pin description

The top die is defined as die 1 and the bottom die as die 2. Single die sensors use the top die only.

Table 4 Pin description

Pin No.	Pin Name	In/Out	TLE5x09A16 - Function	TLE5x09A16D - Function
1	V _{DIAG1}	O	Die 1 bridge voltage proportional to temperature. Diagnostic function	Die 1 bridge voltage proportional to temperature. Diagnostic function
2	V _{DD1}		Die 1 Supply voltage	Die 1 Supply voltage
3	SIN_N1	O	Die 1 Analog negative sine output	Die 1 Analog negative sine output
4	SIN_P1	O	Die 1 Analog positive sine output	Die 1 Analog positive sine output
5	SIN_P2	O	Not connected	Die 2 Analog positive sine output
6	SIN_N2	O	Not connected	Die 2 Analog negative sine output
7	V _{DD2}		Not connected	Die 2 Supply voltage
8	V _{DIAG2}	O	Not connected	Die 2 bridge voltage proportional to temperature. Diagnostic function
9	GND2		Not connected	Die 2 Ground
10	GND2		Not connected	Die 2 Ground
11	COS_N2	O	Not connected	Die 2 Analog negative cosine output
12	COS_P2	O	Not connected	Die 2 Analog positive cosine output
13	COS_P1	O	Die 1 Analog positive cosine output	Die 1 Analog positive cosine output
14	COS_N1	O	Die 1 Analog negative cosine output	Die 1 Analog negative cosine output
15	GND1		Die 1 Ground	Die 1 Ground
16	GND1		Die 1 Ground	Die 1 Ground

Functional description

1.4 Block diagram

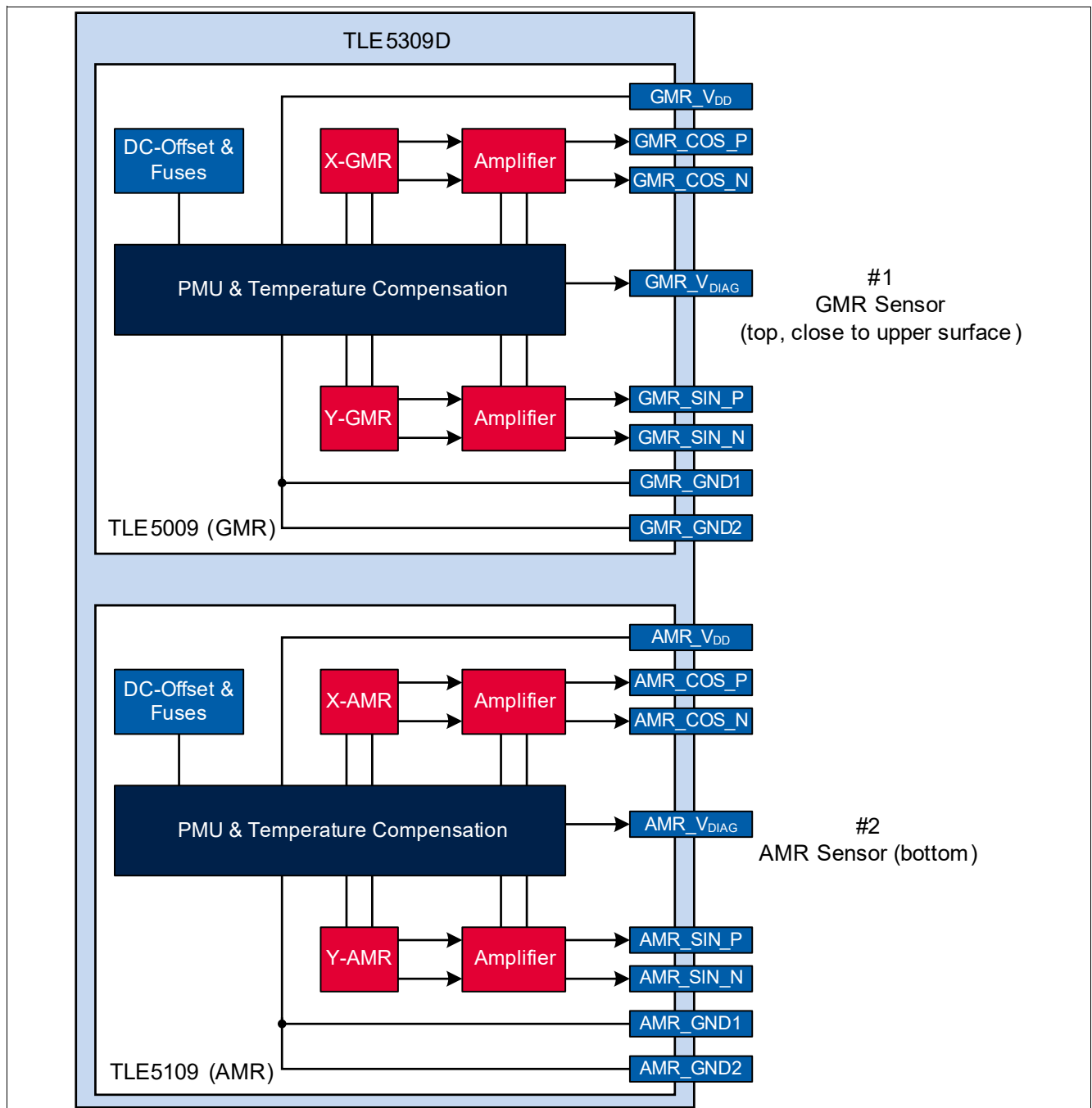

Figure 7 TLE5x09A16(D) block diagram example: TLE5309D sensor with die 1 GMR- and die 2 AMR-sensing technology

Functional description

1.5 Dual die angle output

The TLE5x09A16(D) comprises one MR-based angle sensor IC mounted on the top and one MR-based angle sensor IC mounted on the bottom of a package lead frame in a flipped configuration, so the positions of the sensitive elements in the package-plane coincide. This mounting technique ensures a minimum deviation of the magnetic field orientation sensed by the two chips.

Due to the flipped mounting, the two GMR ICs for the TLE5009A16D sense opposite rotation directions. This behavior is illustrated in **Figure 8**, which shows the angle calculated from the output of the two dies, respectively, for a given external magnetic field orientation.

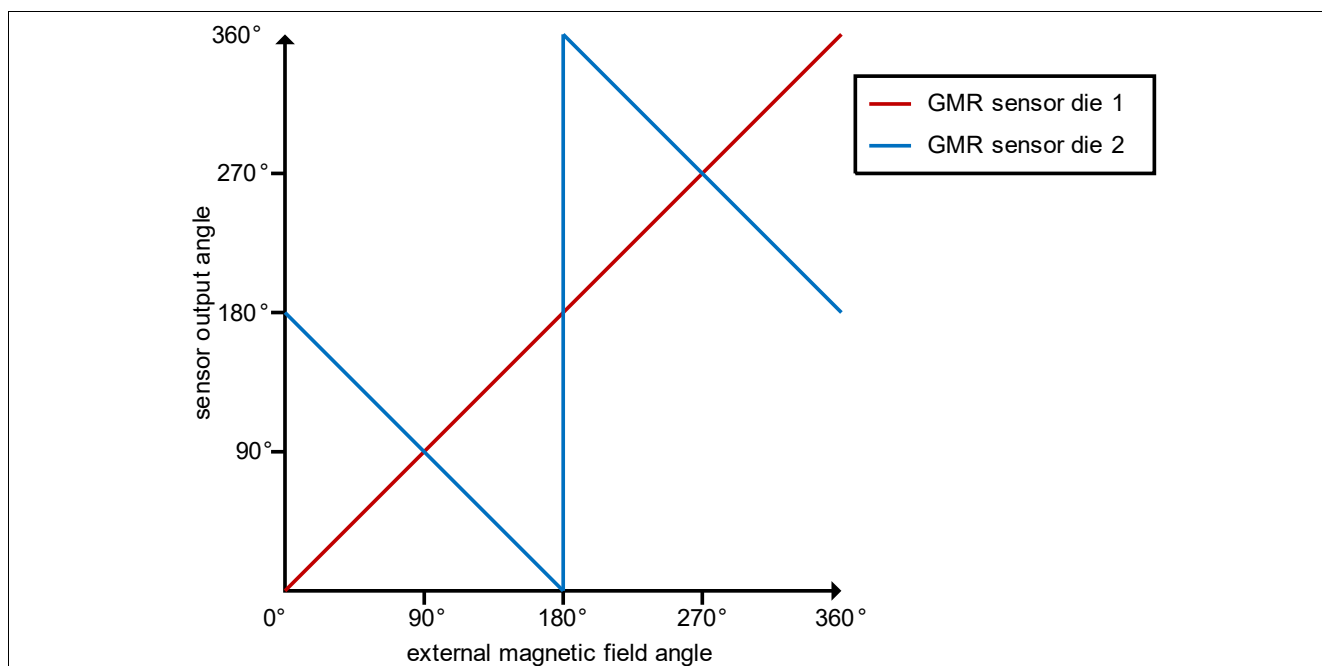

Figure 8 TLE5009A16D Dual die angle output

The TLE5109A16D consists of two AMR ICs sense opposite rotation directions. This behavior is illustrated in **Figure 9**, which shows the angle calculated from the output of the two dies, respectively, for a given external magnetic field orientation.

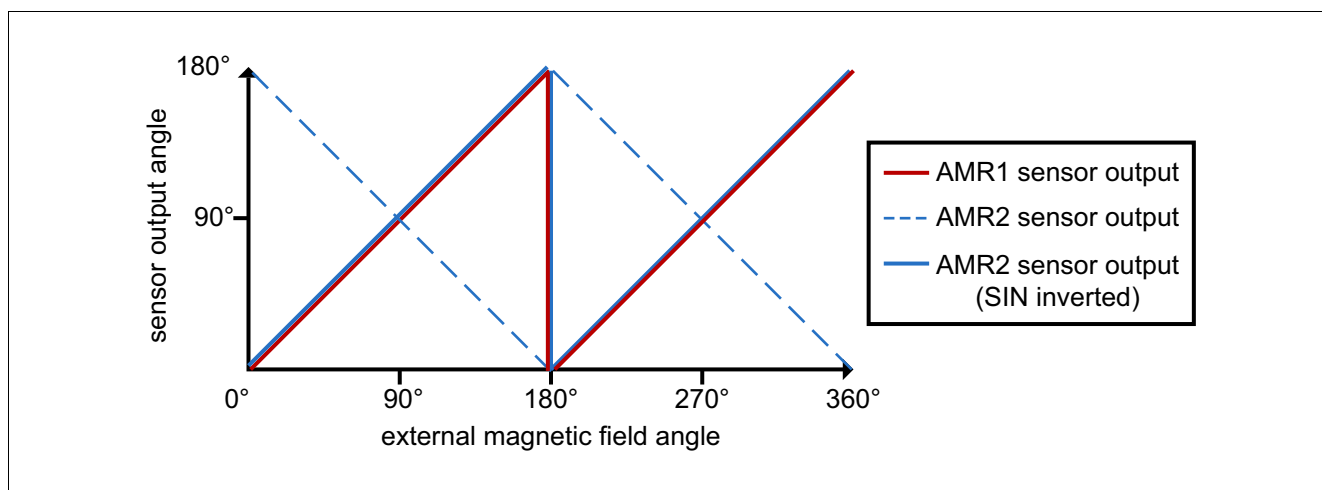

Figure 9 TLE5109A16D Dual die angle output

Functional description

The bottom sensor element of the TLE5309D is an AMR sensor, the signal of which is only unambiguous over 180°. Therefore, in the angle range of 180° to 360° of the GMR sensor, the AMR sensor output signal will be in a range of 0° to 180° again. This behavior is illustrated in **Figure 10**, which shows the angle calculated according to **Equation (1)** and **Equation (2)** from the output of the GMR and AMR sensors, respectively, for a given external magnetic field orientation.

If in an application a different output of the two sensors is desired, the connections to the SIN_N and SIN_P or COS_N and COS_P pins on the printed circuit board can be interchanged. The consequence of this change of connections is that either the differential sine or the cosine signal are inverted, which corresponds to a change of rotation direction (see dashed line in **Figure 9** and **Figure 10**).

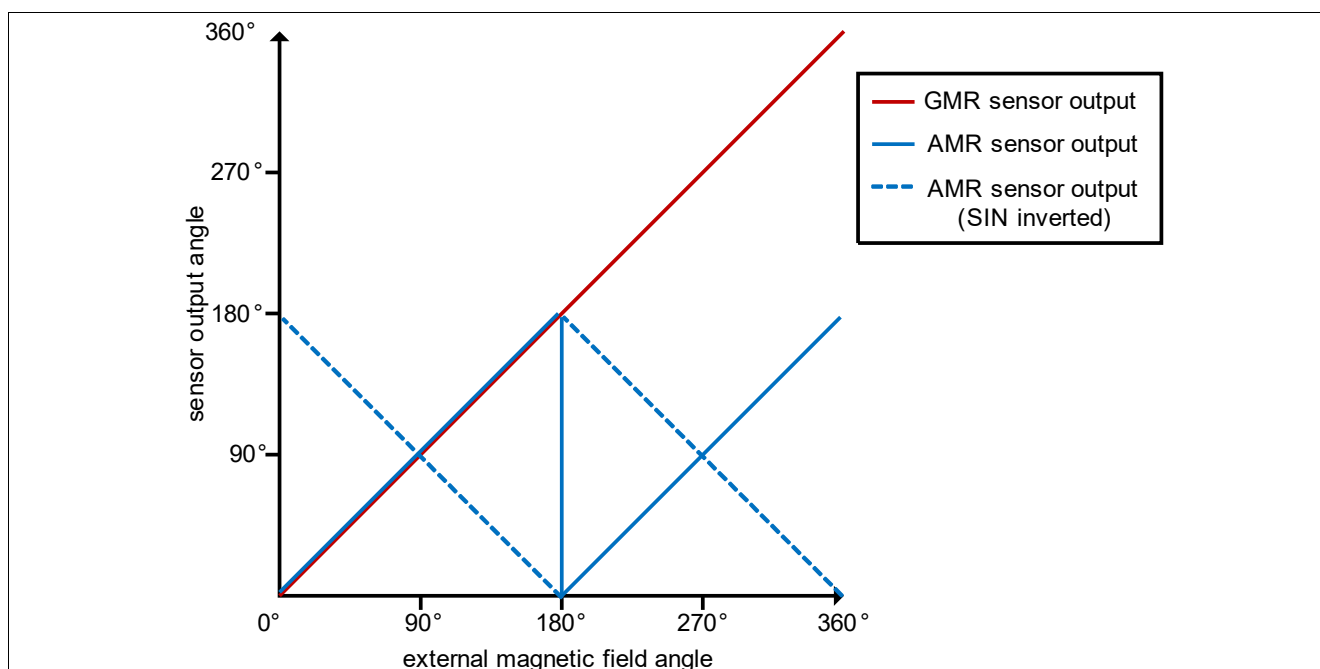

Figure 10 TLE5309D Dual die angle output

Attention: *The positioning accuracy of each sensor IC in the package is $\pm 3^\circ$. In addition, the sensor technology dependent offset of the magnetization must be considered in the overall angle offset. With a GMR sensor the non-orthogonality error can be in worst case $\pm 12^\circ$ according to specification for each die. For AMR this effect is negligible. The non-orthogonality error means the deviation of the 90°-phase correlation from X- and Y-phase. The resulting angle error offsets for AMR and GMR dies are listed in **Table 5**. Both effects can be compensated by an end-of-line calibration including the definition of the zero-phase or X-reference direction. The angle error offsets are not included in the angular accuracy in **Table 11** and **Table 12**.*

Table 5 Angle error offset without end-of-line calibration

	AMR	GMR
Rotational displacement die to package	$\pm 3^\circ$	$\pm 3^\circ$
Magnetization error on die	$\pm 0^\circ$	$\pm 12^\circ$
Overall error	$\pm 3^\circ$	$\pm 15^\circ$

Specification

2 Specification

2.1 Application circuit

The TLE5x09A16(D) sensor can be used in single-ended or differential output mode. **Figure 11** shows a typical application circuit for the TLE5x09A16(D) in single-ended output mode using the positive output channels. For single-ended operation the positive or negative output channels can be used. Unused single-ended output pins should preferably be floating or connected to GND with a high-ohmic resistance (> 100 kΩ). The TLE5x09A16(D) has separate supply pins for the GMR sensor and the AMR sensor. The microcontroller comprises up to 10 A/D inputs used to receive the sensor output signals in differential output mode, illustrated in **Figure 12**. For reasons of EMC and output filtering, the following RC low pass arrangement is recommended. The RC low pass has to be adapted according to the applied rotation speed. ¹⁾

Attention: Unused output pins should not be connected.

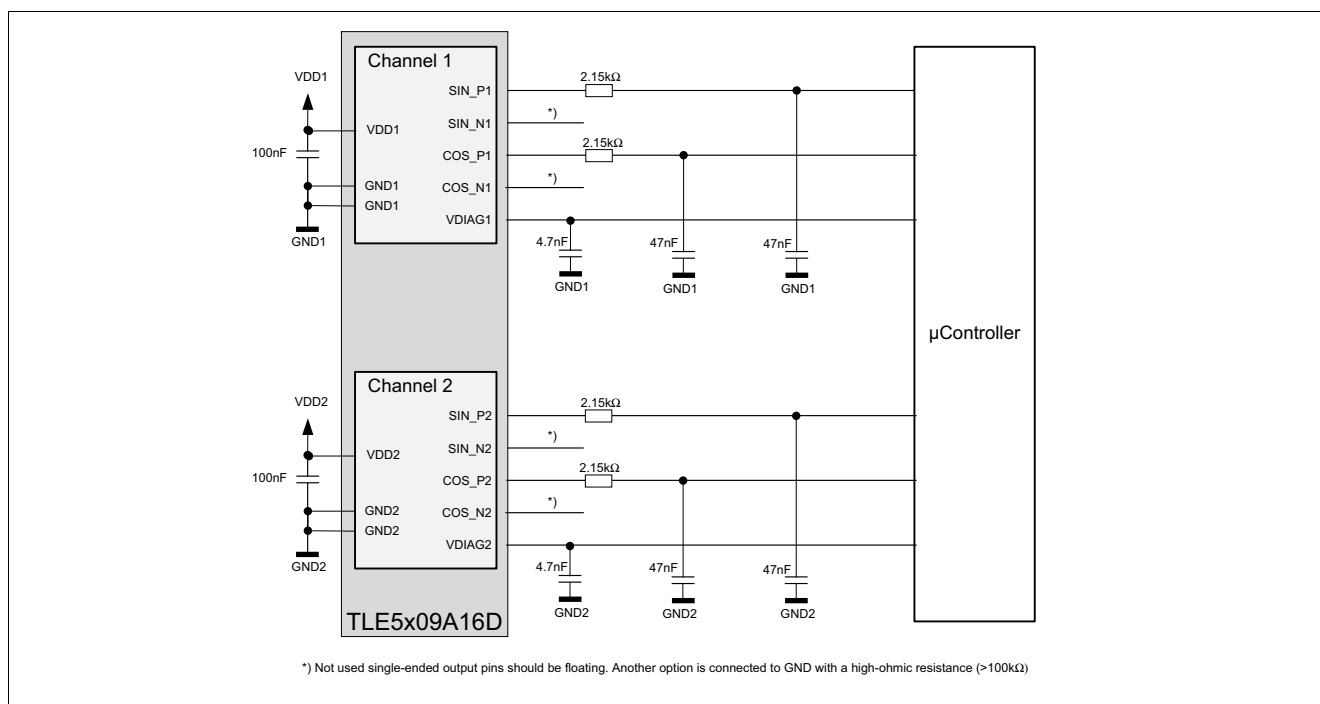

Figure 11 Application circuit for the TLE5x09A16(D) in single-ended output mode; positive output channels used

1) E. g. the RC low pass with R=2.15kΩ and C=47nF is appropriate for a rotation speed up to 10,000 rpm.

Specification

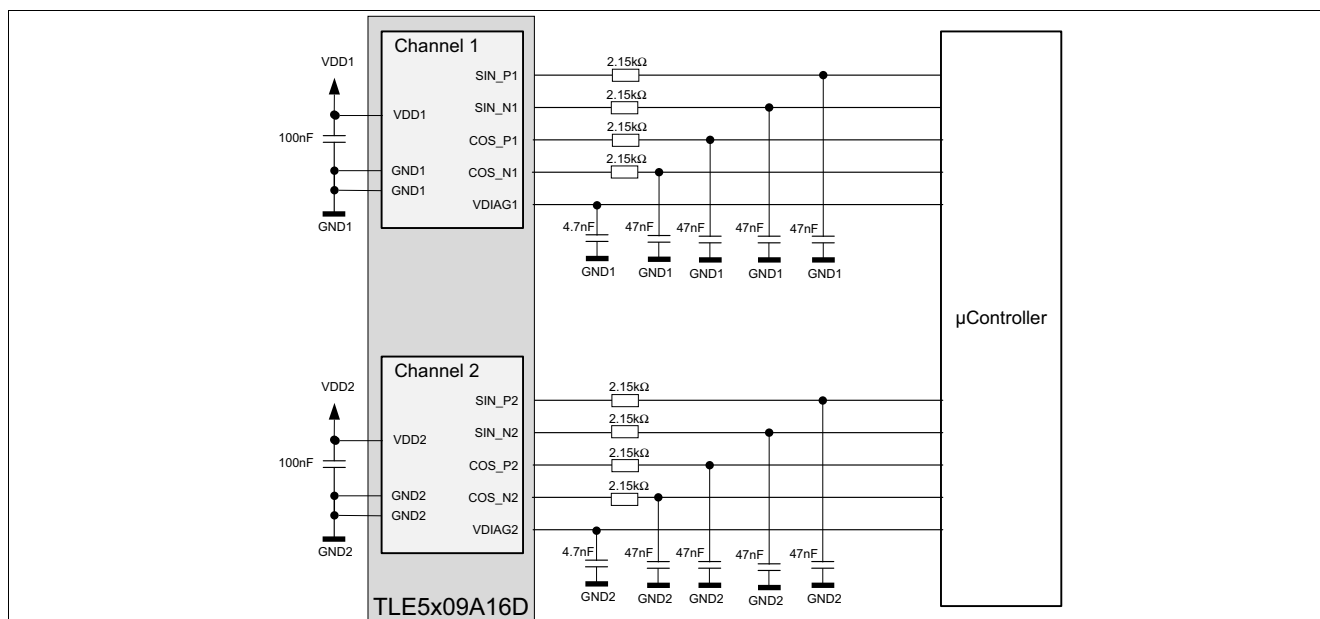

Figure 12 Application circuit for the TLE5x09A16(D) in differential output mode

Application circuit for low-power consumption (e.g. turn counter)

Applications that use electric motors and actuators may require a turn counter function. A turn counter function allows to keep track of the electric motor or actuator position with low-power consumption. During operation the sensor is powered on, therefore the angle information is constantly available and, if necessary, stored. But when the system is not in operation the sensor is powered off to save power consumption, therefore rotational movements are not detected. To avoid missing the position the sensor can be awaked periodically to obtain the angle information. The minimum length of the awake time must cover the TLE5x09A16(D) power-up time (described in [Table 8](#)) and the required time to transmit the data, which is also dependent on the application circuit.

An optimal TLE5309D application circuit for systems with turn counter function is shown in [Figure 13](#) for single-ended output respectively in [Figure 14](#) for differential output. The AMR sensor is used for high precise angle measurement in normal operation and the GMR sensor for turn counter function. With a lower resistor and capacitor design the low-pass filter time constant can be adapted for high speed applications. Therefore, the time needed to supply the TLE5309D with power in order to read the output signal is considerably reduced.

Specification

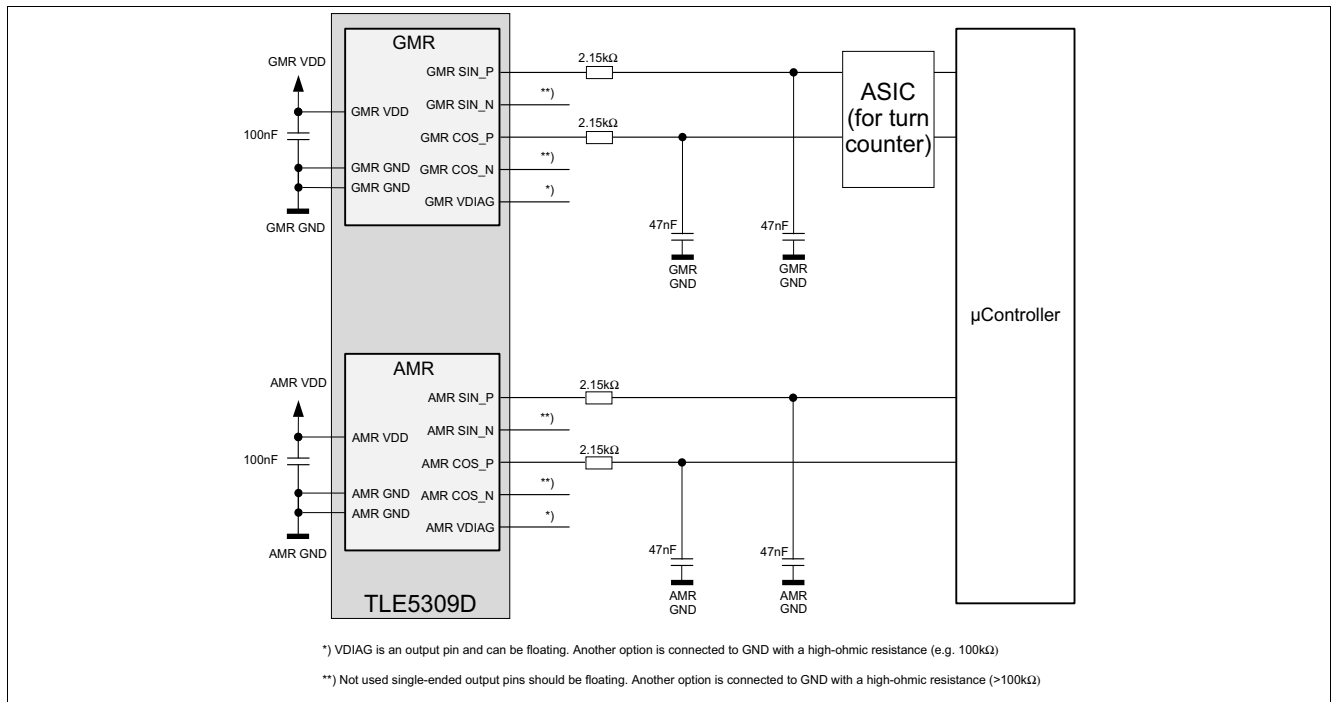

Figure 13 Application circuit for the TLE5309D in low-power applications in single-ended output mode (e.g. turn counter); positive output channels used

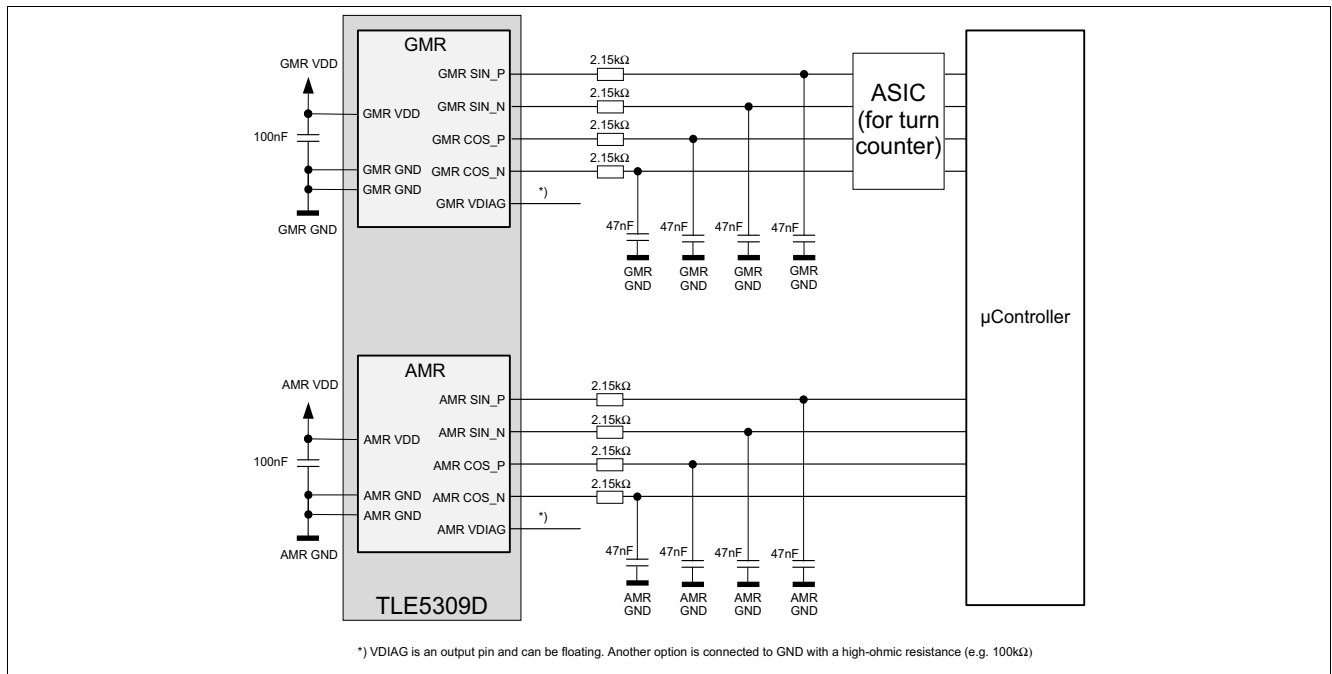

Figure 14 Application circuit for the TLE5309D in low-power applications in differential output mode (e.g. turn counter)

Pull-down resistors for partial diagnostics

It is also possible to use pull-down resistors to get partial diagnostics. With this setting it is not required to use the V_{DIAG} pin. The application circuit with pull-down resistors is shown in [Figure 15](#) for single-ended output respectively in [Figure 16](#) for differential output. For further details please refer to the [Safety Manual](#).

Specification

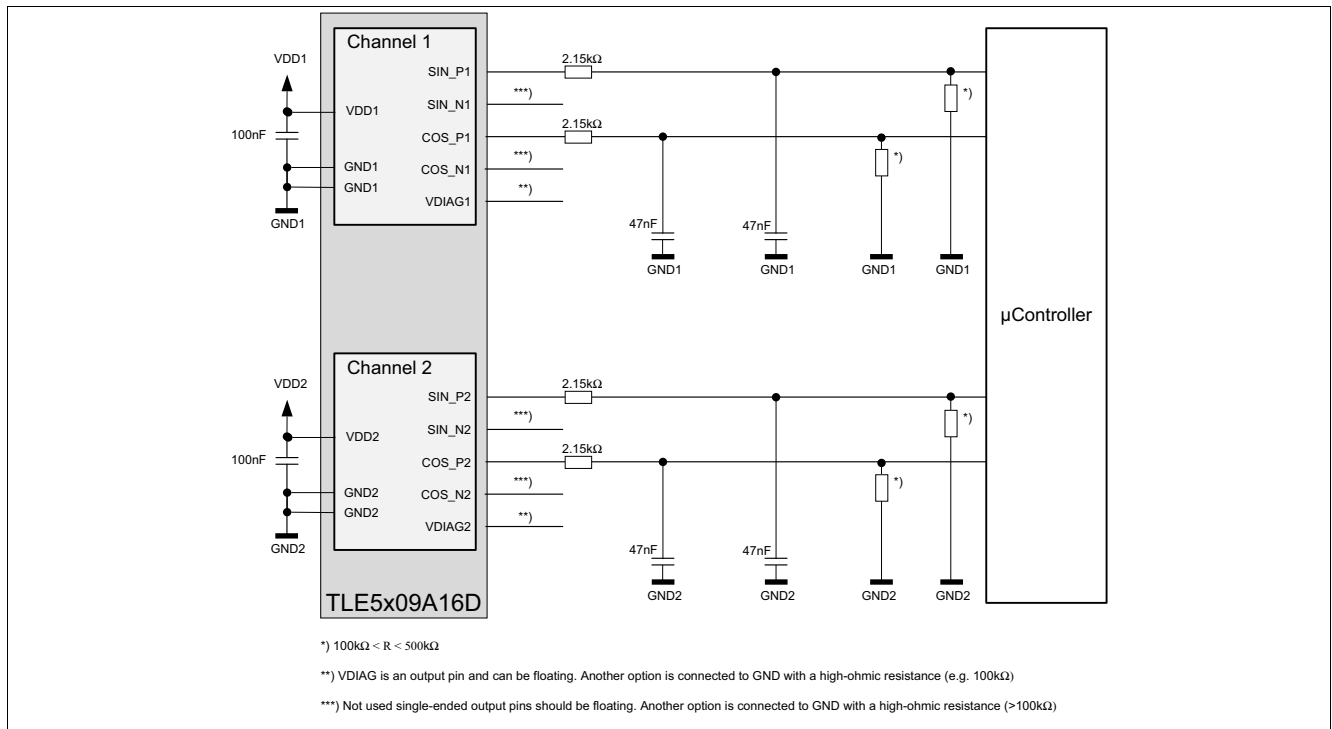

Figure 15 Application circuit for the TLE5x09A16(D) for partial diagnostics with pull-down resistors in single-ended output mode; positive output channels used

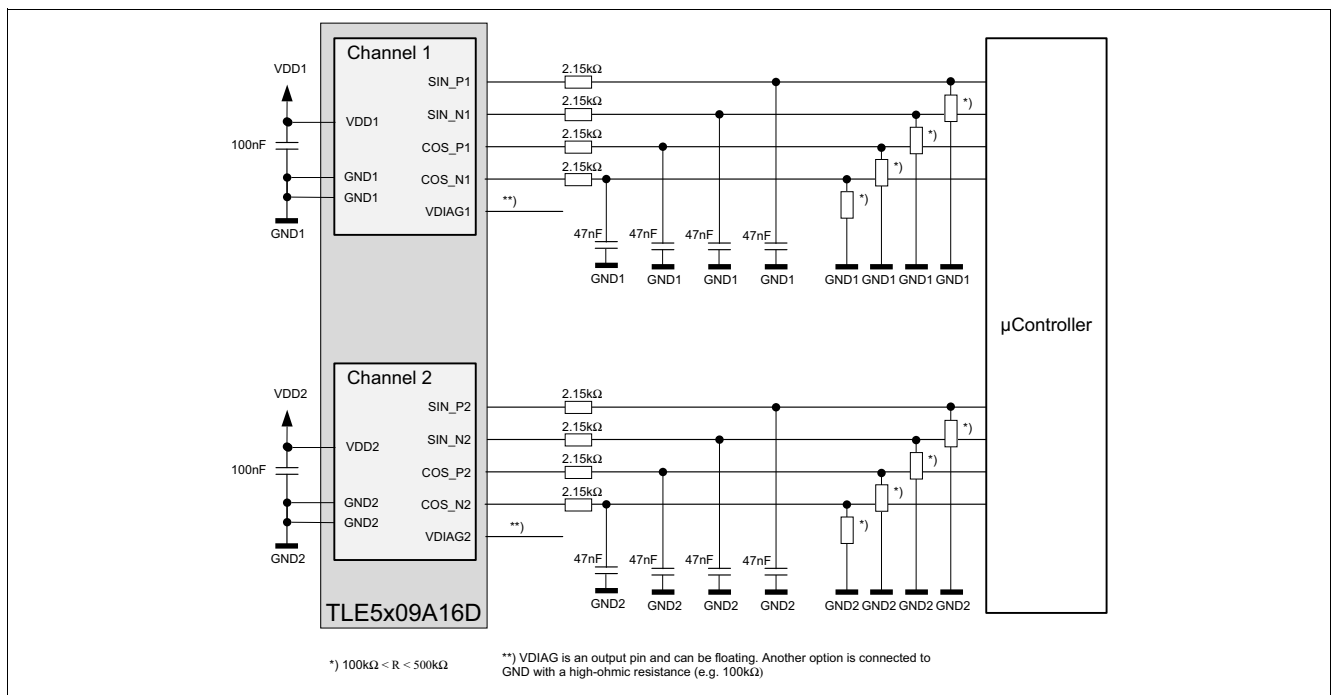

Figure 16 Application circuit for the TLE5x09A16(D) for partial diagnostics with pull-down resistors in differential output mode

Specification

2.2 Absolute maximum ratings

Table 6 Absolute maximum ratings

Parameter	Symbol	Values			Unit	Note or Test Condition
		Min.	Typ.	Max.		
Supply voltage	V_{DD}	-0.5		6.5	V	Max. 40 h over lifetime
Ambient temperature ¹⁾	T_A	-40		140	°C	
Magnetic field induction	B			200	mT	Max. 5 min. at $T_A = 25^\circ\text{C}$
				150	mT	Max. 5 h at $T_A = 25^\circ\text{C}$

1) Assuming a thermal resistance of the sensor assembly in the application of 150 K/W or less.

Attention: *Stresses above the max. values listed here may cause permanent damage to the device. Exposure to absolute maximum rating conditions for extended periods may affect device reliability. Maximum ratings are absolute ratings; exceeding only one of these values may cause irreversible damage to the device.*

Specification

2.3 Sensor specification

The following operating conditions must not be exceeded in order to ensure correct operation of the TLE5x09A16(D).

All parameters specified in the following sections refer to these operating conditions, unless otherwise noted. **Table 7** is valid for $-40^{\circ}\text{C} < T_A < 125^{\circ}\text{C}$ and through the TLE5x09A16(D) lifetime. Parameters are valid for AMR and GMR sensor, unless otherwise noted.

2.3.1 Operating range

Table 7 Operating range

Parameter	Symbol	Values			Unit	Note or Test Condition
		Min.	Typ.	Max.		
Ambient temperature ¹⁾	T_A	-40		125	$^{\circ}\text{C}$	
Supply voltage GMR ²⁾	$V_{DD, GMR}$	3.0	3.3	3.6	V	E1200, E1210, E1211, E5201
		4.5	5	5.5	V	E2200, E2210, E2211
Supply voltage AMR ²⁾	$V_{DD, AMR}$	3.0	3.3	3.6	V	E1210, E1211
		4.5	5	5.5	V	E2210, E2211, E5201
Output current ³⁾⁴⁾	I_Q	0		0.5	mA	COS_N; COS_P; SIN_N; SIN_P
		0		0.1	mA	V_{DIAG}
Load capacitance ³⁾⁵⁾	C_L	0		4.7	nF	All output pins - without series resistor
Magnetic induction GMR ¹⁾³⁾⁶⁾⁷⁾	B_{XY}	24		60	mT	In X/Y direction, at $T_A = 25^{\circ}\text{C}$
		26		100	mT	In X/Y direction, at $T_A = -40^{\circ}\text{C}$
		21		50	mT	In X/Y direction, at $T_A = 125^{\circ}\text{C}$
Magnetic induction AMR ³⁾⁶⁾	B_{XY}	20			mT	in X/Y direction, tested up to 500 mT quasi-static
Angle range	α	0		360	$^{\circ}$	(AMR is 180°-periodic, see Chapter 1.5)
Rotation speed ³⁾⁸⁾	n			30,000	rpm	
				150,000	rpm	No signal degradation observed in lab

- 1) Assuming a thermal resistance of the sensor assembly in the application of 150 K/W or less.
- 2) Supply voltage V_{DD} buffered with 100 nF ceramic capacitor in close proximity to the sensor.
- 3) Not subject to production test - verified by design/characterization.
- 4) Assuming a symmetrical load.
- 5) Directly connected to the pin.
- 6) Values refer to a homogenous magnetic field (B_{XY}) without vertical magnetic induction ($B_Z = 0$ mT).
- 7) Min/Max values for magnetic field for intermediate temperatures can be obtained by linear interpolation.
- 8) Typical angle propagation delay error is 1.62° at 30,000 rpm.

Specification

2.3.2 Electrical parameters

The indicated electrical parameters apply to the full operating range, unless otherwise specified. The typical values correspond to the specified supply voltage range and 25°C, unless individually specified. All other values correspond to $-40^{\circ}\text{C} < T_A < 125^{\circ}\text{C}$ and through the TLE5x09A16(D) lifetime.

Table 8 Electrical parameters

Parameter	Symbol	Values			Unit	Note or Test Condition
		Min.	Typ.	Max.		
Supply current GMR	I_{DD}		7	10.5	mA	Without load on output pins
Supply current AMR			6	9.5	mA	Without load on output pins
POR level	V_{POR}	2.3	2.65	2.97	V	Power-On Reset
POR hysteresis ¹⁾	V_{PORhy}		50		mV	
Power-On time ²⁾	t_{PON}		40	70	μs	Settling time to 90% of full output voltages
Temperature reference voltage	V_{DIAG}	0.5	1.05	2.0	V	Temperature proportional output voltage; available on pin V_{DIAG}
Diagnostic function	V_{DIAG}	0		0.39	V	Diagnostic for internal errors; available on pin V_{DIAG}
Temperature coefficient of V_{DIAG} ¹⁾	$TC_{V_{DIAG}}$		0.4		%/K	

1) Not subject to production test - verified by design/characterization.

2) Time measured at chip output pins.

2.3.3 Output parameters

All parameters apply over the full operating range, unless otherwise specified. The parameters in **Table 9** refer to single pin output and **Table 10** to differential output. For variable names please refer to **Figure 17 “GMR sensor single-ended output signals” on Page 20** and **Figure 19 “GMR differential output of ideal cosine” on Page 21**.

The following equations describe various types of errors that combine to the overall angle error.

The maximum and zero-crossing of the SIN and COS signals do not occur at the precise angle of 90°. The difference between the X and Y phases is called the **orthogonality** error. In **Equation (3)** the angle at zero crossing of the **X** COS output is subtracted from the angle at the maximum of the **Y** SIN output, which describes the orthogonality of X and Y.

$$\varphi = \alpha[Y_{max}] - \alpha[X_0] \tag{3}$$

The amplitudes of SIN and COS signals are not equal to each other. The amplitude mismatch is defined as **synchronism**, shown in **Equation (4)**. This value could also be described as amplitude ratio mismatch.

$$k = 100 * \frac{A_x}{A_y} \tag{4}$$

Specification

The sensor outputs 4 single-ended signals SIN_N, SIN_P, COS_N, and COS_P, which are centered at the voltage offset $0.5 \cdot V_{DD}$. The **differential signals** are calculated from the single-ended signals. The differential voltages for X or Y are defined in [Equation \(5\)](#).

$$\begin{aligned} V_{Xdiff} &= V_{COSP} - V_{COSN} \\ V_{Ydiff} &= V_{SINP} - V_{SINN} \end{aligned} \tag{5}$$

The maximum amplitudes for the differential signals are centered at 0 V and defined for X or Y as given in [Equation \(6\)](#):

$$\begin{aligned} A_{Xdiff} &= \frac{(X_{diff_MAX} - X_{diff_MIN})}{2} \\ A_{Ydiff} &= \frac{(Y_{diff_MAX} - Y_{diff_MIN})}{2} \end{aligned} \tag{6}$$

Differential offset of X or Y is defined in [Equation \(7\)](#).

$$\begin{aligned} O_{Xdiff} &= \frac{(X_{diff_MAX} + X_{diff_MIN})}{2} \\ O_{Ydiff} &= \frac{(Y_{diff_MAX} + Y_{diff_MIN})}{2} \end{aligned} \tag{7}$$

In **single-ended mode** the offset is defined as the mean output voltage and equals typically $0.5 \cdot V_{DD}$. For further details please refer to the application note [“TLE5xxx\(D\) Calibration”](#).

Table 9 Single-ended output parameters over temperature and lifetime

Parameter	Symbol	Values			Unit	Note or Test Condition
		Min.	Typ.	Max.		
X, Y amplitude	A_X, A_Y	0.7		1.3	V	Sensors with 3.3 V supply
		1.2		1.95	V	Sensors with 5.0 V supply
X, Y synchronism	k	94	100	106	%	GMR
		94	100	106	%	AMR
X, Y orthogonality error	ϕ	-12		12	°	GMR (AMR negligible)
Mean output voltage	V_{MVX}, V_{MVG}	$0.47 \cdot V_{DD}$	$0.5 \cdot V_{DD}$	$0.53 \cdot V_{DD}$	V	$V_{MV} = (V_{max} + V_{min}) / 2$ ¹⁾
X, Y cut off frequency ²⁾	f_c		30		kHz	-3 dB attenuation
X, Y delay time ²⁾³⁾	t_{adel}		9		µs	
Output noise ²⁾	V_{Noise}		5		mV	RMS

1) V_{max} and V_{min} correspond to the voltage levels at X_{max} or Y_{max} and X_{min} or Y_{min} respectively as shown in [Figure 17](#), [Figure 18](#).

2) Not subject to production test - verified by design/characterization

3) Time measured at chip output pins.

Specification

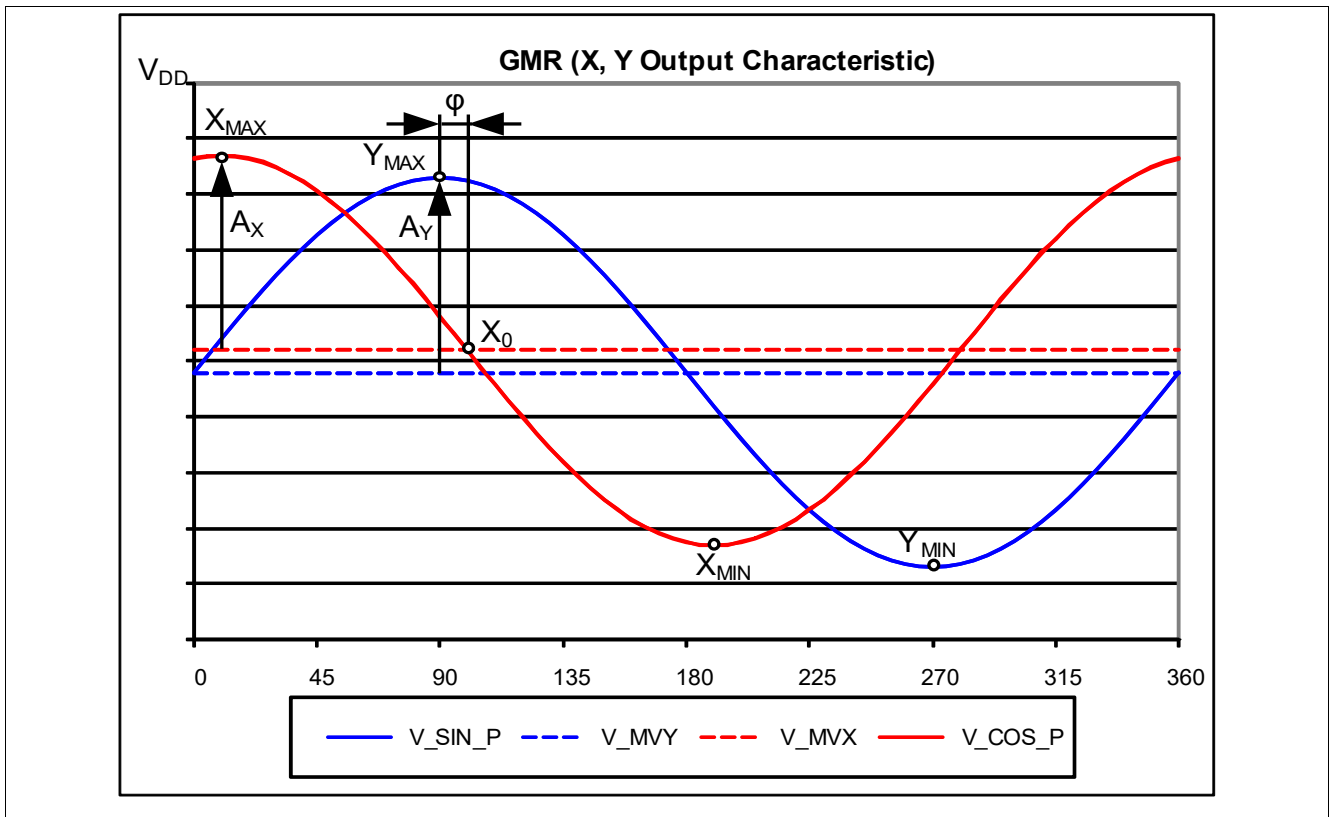

Figure 17 GMR sensor single-ended output signals

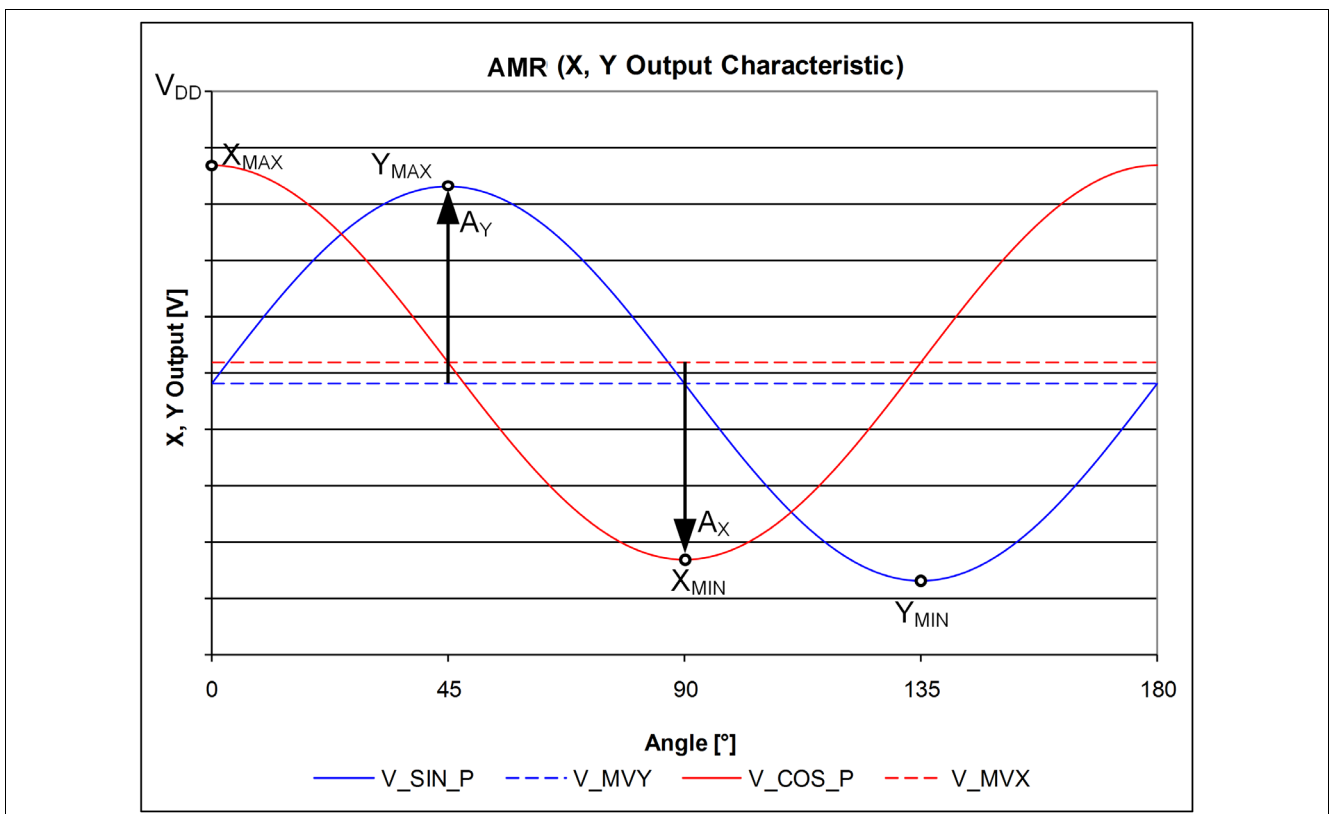

Figure 18 AMR sensor single-ended output signals

Specification

Table 10 Differential output parameters over temperature and lifetime

Parameter	Symbol	Values			Unit	Note or Test Condition
		Min.	Typ.	Max.		
X, Y amplitude	A_{Xdiff}, A_{Ydiff}	1.4		2.6	V	Sensors with 3.3 V supply
		2.4		3.9	V	Sensors with 5.0 V supply
X, Y synchronism	k	94	100	106	%	GMR
		94	100	106	%	AMR
X, Y orthogonality error	ϕ	-12		12	°	GMR (AMR negligible)
X, Y offset	O_{Xdiff}, O_{Ydiff}	-100	0	100	mV	GMR
		-200	0	200	mV	AMR
X, Y cut-off frequency ¹⁾	f_c		30		kHz	-3 dB attenuation
X, Y delay time ¹⁾²⁾	t_{adel}		9		µs	
Output noise ¹⁾	V_{Noise}		5		mV	RMS

1) Not subject to production test - verified by design/characterization.

2) Time measured at chip output pins.

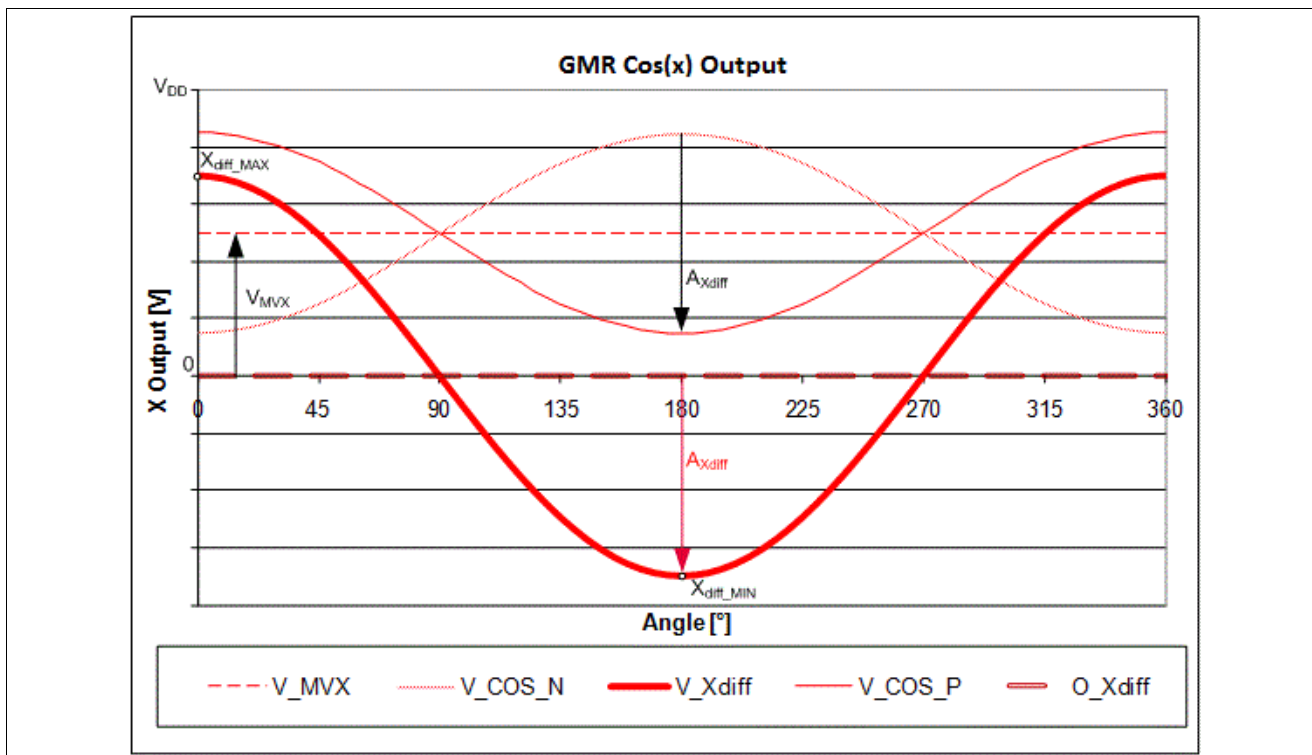

Figure 19 GMR differential output of ideal cosine

Specification

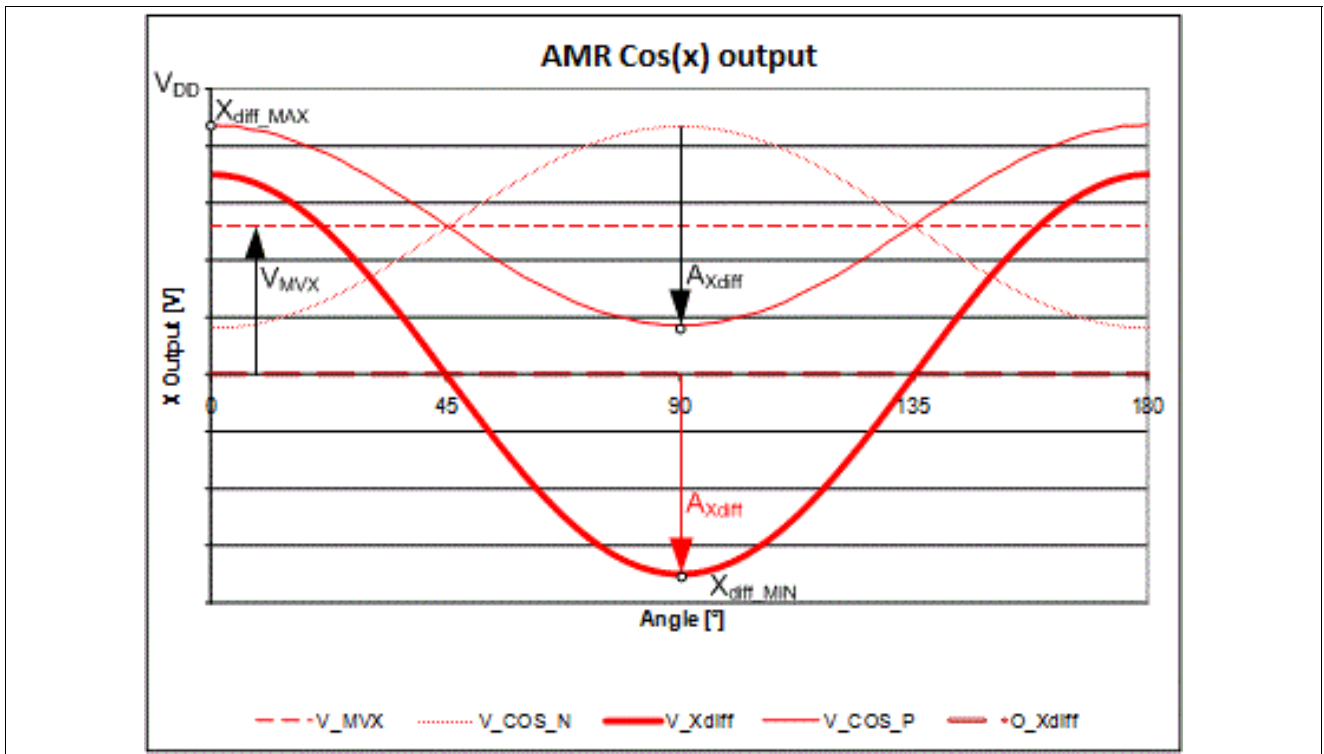

Figure 20 AMR differential output of ideal cosine

Attention: The misalignment of the magnetization depends on the sensing technology. With a GMR sensor the non-orthogonality error can be in worst case +/-12° according to specification for each die. For AMR this effect is negligible. The non-orthogonality error, which means the deviation of the 90°-phase correlation from X- and Y-phase, can be compensated through an end-of-line calibration including the definition of the zero-phase or X-reference direction. This applies to each sensor die and has to be taken into account during operation of the TLE5x09A16(D).

Specification

2.4 Error diagnosis

Each sensor provides two functions at its V_{DIAG} pin. During normal operation the voltage measured at this pin is temperature dependent. The typical voltage at room temperature and the temperature coefficient are given in **Table 8**. The temperature accuracy is not part of the sensor qualification.

The second purpose of pin V_{DIAG} is the diagnosis functionality. In case the device detects an internal error, the pin is driven to a low level. Another option for obtaining partial diagnostic functions is the alternative configuration with pull-down resistors described in **Figure 16**. With this setting, it is not required to use the V_{DIAG} pin, but internal error detection is also reduced. For further details please refer to the **Safety Manual**.

2.5 Angle performance

The overall angle error represents the relative angular error. This error describes the deviation from the reference line after zero angle definition. The typical value corresponds to an ambient temperature of 25°C. All other values correspond to the operating ambient temperature range $-40^{\circ}\text{C} < T_A < 125^{\circ}\text{C}$ and through the TLE5x09A16(D) lifetime.

Fully compensated performance

Using the algorithm described in the application note “**TLE5xxx(D) Calibration**”, it is possible to implement an ongoing automatic calibration on the microcontroller to greatly improve the performance of the TLE5x09A16(D), as temperature and lifetime drifts are better compensated. This is only possible in applications where a rotor is turning continuously.

Table 11 Residual angle error over temperature and lifetime¹⁾

Parameter	Symbol	Values			Unit	Note or Test Condition
		Min.	Typ.	Max.		
Overall angle error AMR sensor (single-ended) ²⁾³⁾	$\alpha_{ERR,C}$		0.1	0.5	°	4)
Overall angle error AMR sensor (differential) ²⁾	$\alpha_{ERR,C}$		0.1	0.5	°	4)
Overall angle error GMR sensor (single-ended) ²⁾³⁾	$\alpha_{ERR,C}$		< 0.6	0.9	°	
Overall angle error GMR sensor (differential) ²⁾	$\alpha_{ERR,C}$		< 0.6	0.9	°	

- 1) After perfect compensation of offset, amplitude synchronicity mismatch and orthogonality error.
- 2) Including hysteresis error.
- 3) Assuming a symmetrical load.
- 4) For AMR sensor only: an additional angle error of 0.2° applies to operation in the magnetic field $10\text{ mT} < B < 20\text{ mT}$

With this auto calibration algorithm, it is possible to reach an angular accuracy as good as the residual error of the sensing elements, which means the remaining error after perfect compensation of offset and amplitude synchronicity mismatch for both the AMR and the GMR sensors and perfect compensation of orthogonality error for the GMR sensor. A typical behavior of a fully compensated angle error with this ongoing calibration is shown in **Figure 21** for the GMR sensor and **Figure 22** for the AMR sensor for different ambient temperatures. The accuracy of the fully compensated angle is listed in **Table 11**, which is divided into single-ended and differential output of the sensor.

Specification

Angle performance with one-time calibration

To achieve the overall angle error specified, both sensor ICs in the TLE5x09A16(D) have to be calibrated for offset and amplitude synchronism at 25°C. Additionally, the GMR sensor has to be calibrated for orthogonality. The compensation parameters have to be stored and applied on the microcontroller. For the detailed calibration procedure refer to the application note “**TLE5xxx(D) Calibration**”. **Table 12** characterizes the accuracy of the angle, which is calculated from the single-ended output respectively the differential output of the sensor and the compensation parameters acquired in the end-of-line calibration.

Table 12 One-time calibrated angle error over temperature and lifetime

Parameter	Symbol	Values			Unit	Note or Test Condition
		Min.	Typ.	Max.		
Overall angle error AMR sensor (single-ended) ¹⁾²⁾	α_{ERR}			1.7	°	E1210, E1211, E2210, E2211, with TCO ³⁾ ; ⁴⁾
				2.9	°	E5201, without TCO ³⁾ ; ⁴⁾
Overall angle error AMR sensor (differential) ¹⁾	α_{ERR}			1.7	°	E1210, E1211, E2210, E2211, with TCO ³⁾ ; ⁴⁾
				2.9	°	E5201, without TCO ³⁾ ; ⁴⁾
Overall angle error GMR sensor (single-ended) ¹⁾²⁾	α_{ERR}			4.0	°	E1210, E1211, E2210, E2211, with TCO ³⁾
				4.8	°	E1200, E2200, E5201, without TCO ³⁾
Overall angle error GMR sensor (differential) ¹⁾	α_{ERR}			3.0	°	E1210, E1211, E2210, E2211, with TCO ³⁾
				3.8	°	E1200, E2200, E5201, without TCO ³⁾

- 1) Including hysteresis error.
- 2) Assuming a symmetrical load.
- 3) Temperature Compensation Offset.
- 4) For AMR sensor only: an additional angle error of 0.2° applies to operation in the magnetic field 10 mT < B < 20 mT.

Typical behaviour of angle error compensation

The angle accuracy performance for ideal compensation and one-time compensation is listed in **Table 11** respectively in **Table 12**. **Figure 21** shows for the GMR sensor and **Figure 22** for the AMR sensor the typical behavior of the residual angle error with ongoing respectively one-time calibration at different ambient temperatures. The comparison of this compensation algorithms demonstrates the superior performance of the full compensation method over lifetime and temperature with an average residual error below 0.6° for the GMR sensor and 0.1° for the AMR sensor operating in the specified magnetic field. With one-time compensation an additional residual angle error occurs due to the temperature dependency of the sensor.

Specification

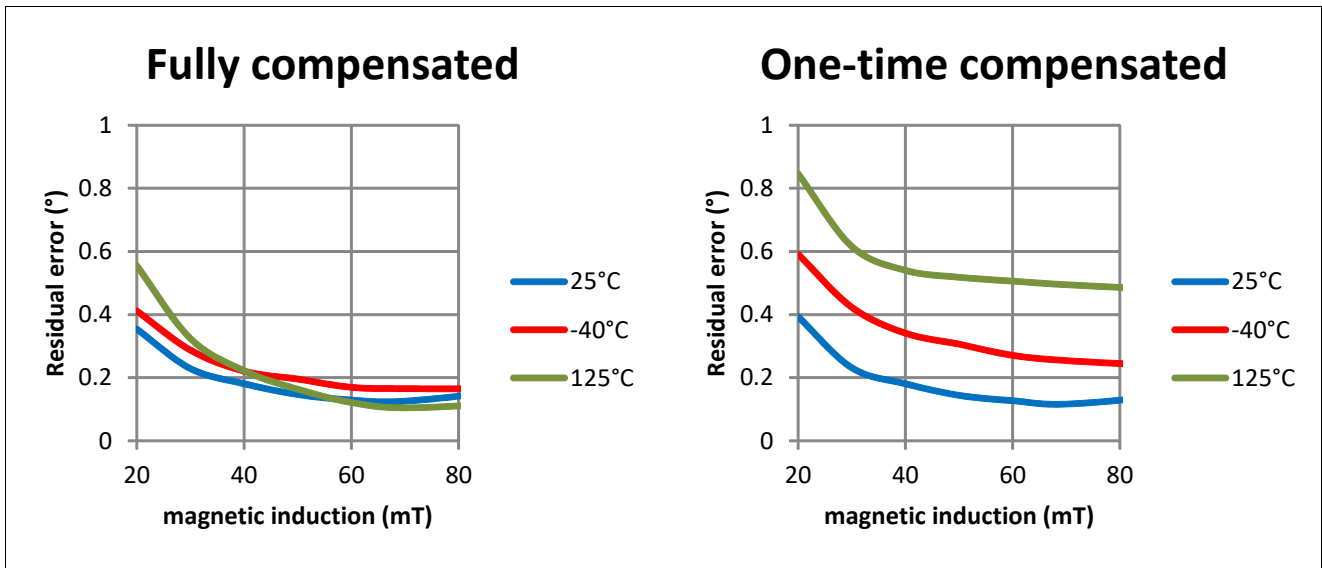

Figure 21 Typical residual angle error of fully and one-time compensated GMR sensor for differential output at different temperatures (measured at 0 h); one-time compensation is calibrated at $T = 25^{\circ}\text{C}$ and $B = 40\text{ mT}$; TLE5309D derivative with $\text{TCO}^{1)}$ and 3.3 V supply voltage is used

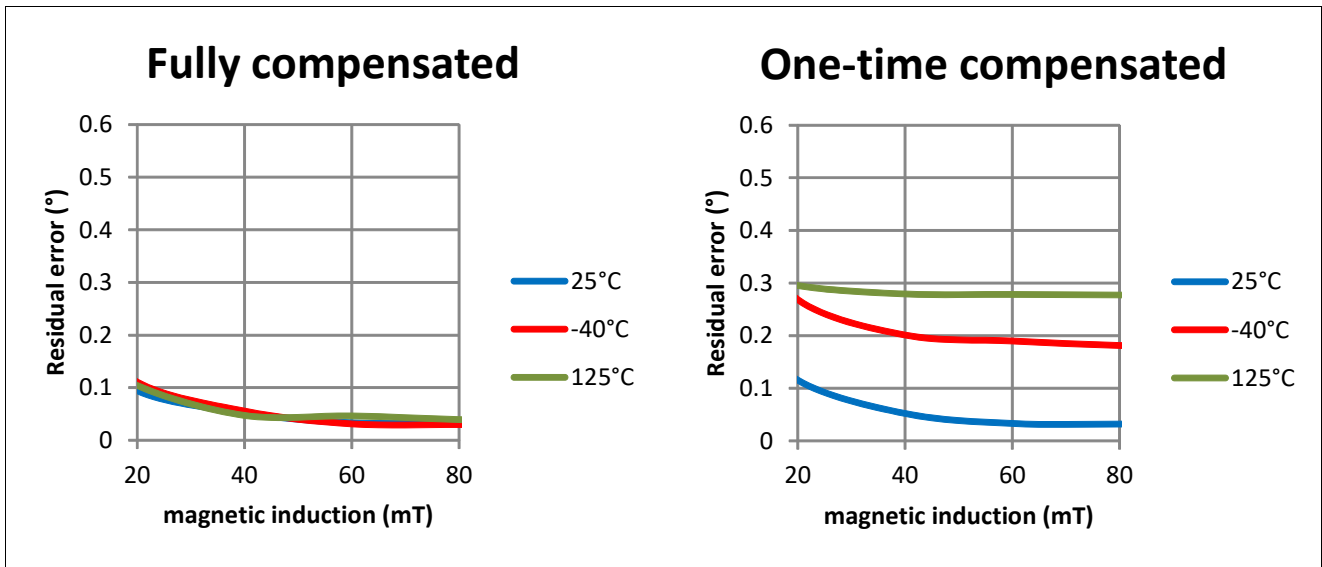

Figure 22 Typical residual angle error of fully and one-time compensated AMR sensor for differential output at different temperatures (measured at 0 h); one-time compensation is calibrated at $T = 25^{\circ}\text{C}$ and $B = 40\text{ mT}$; TLE5309D derivative with $\text{TCO}^{1)}$ and 3.3 V supply voltage is used

1) Temperature Compensation Offset

Specification

2.6 Electrostatic discharge protection

Table 13 ESD protection for single die

Parameter	Symbol	Values		Unit	Notes
		min.	max.		
ESD voltage	V_{HBM}		±4.0	kV	¹⁾
	V_{CDM}		±0.5	kV	²⁾
			±0.75	kV	²⁾ for corner pins

1) Human Body Model (HBM) according to: ANSI/ESDA/JEDEC JS-001.

2) Charged Device Model (CDM) according to: JESD22-C101.

Table 14 ESD protection for dual die

Parameter	Symbol	Values		Unit	Notes
		min.	max.		
ESD voltage	V_{HBM}		±4.0	kV	¹⁾ Ground pins connected.
			±2.0	kV	¹⁾
	V_{CDM}		±0.5	kV	²⁾
			±0.75	kV	²⁾ For corner pins.

1) Human Body Model (HBM) according to ANSI/ESDA/JEDEC JS-001.

2) Charged Device Model (CDM) according to JESD22-C101.

2.7 Electro magnetic compatibility (EMC)

The TLE5x09A16(D) is characterized according to the EMC requirements described in the “Generic IC EMC Test Specification” Version 1.2 from November 15, 2007. The classification of the TLE5x09A16(D) is done for local pins.

Package information

3 Package information

The TLE5x09A16(D) is delivered in a green SMD package with lead-free plating, the same **PG-TDSO-16** is used for the single die and the dual die derivatives.

3.1 Package parameters

Table 15 Package parameters

Parameter	Symbol	Limit Values			Unit	Notes
		min.	typ.	max.		
Thermal Resistance	R_{thJA}		130	150	K/W	Junction-to-Air ¹⁾
	R_{thJC}			35	K/W	Junction-to-Case
	R_{thJL}			70	K/W	Junction-to-Lead
Moisture Sensitivity Level	MSL 3					260°C
Lead Frame	Cu					
Plating	Sn 100%					> 7 μm

1) According to Jeduc JESD51-7

3.2 Package outlines

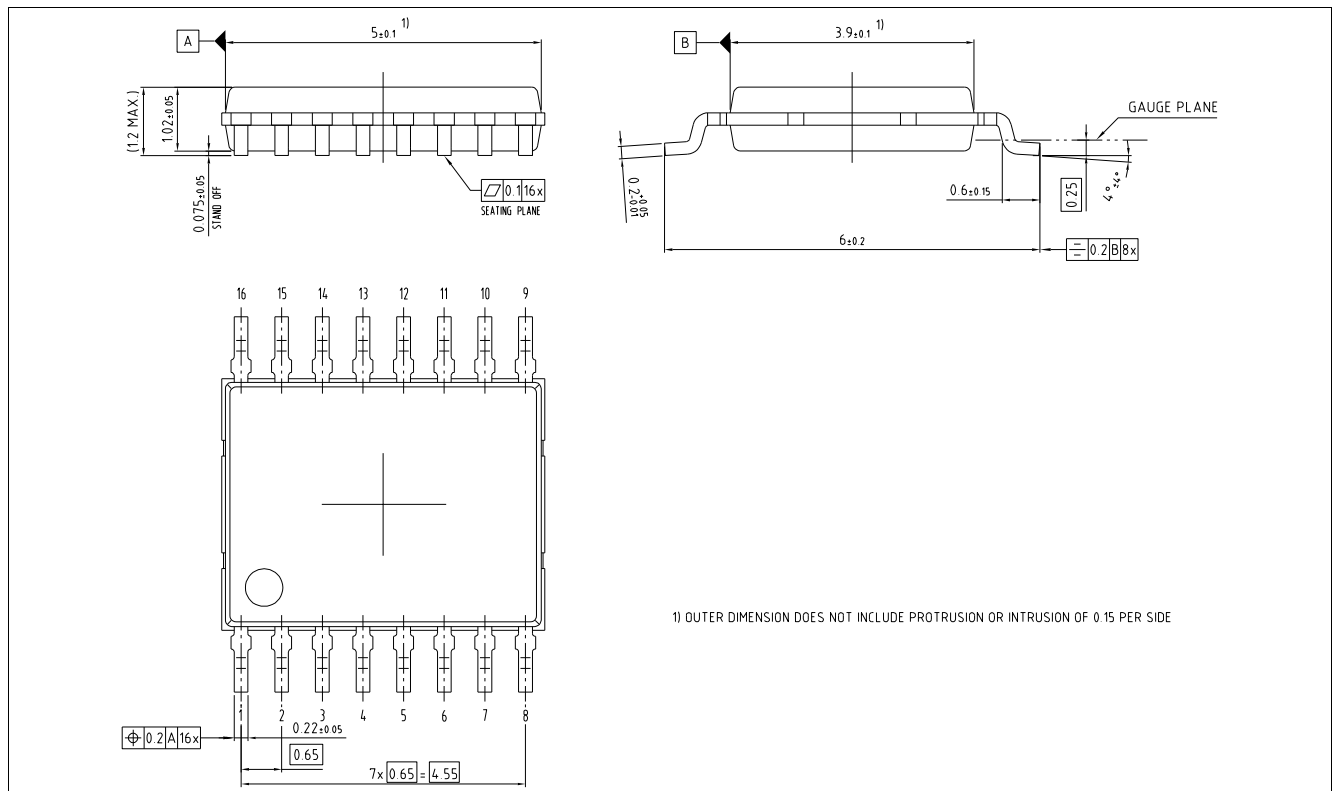

Figure 23 Package dimensions

Package information

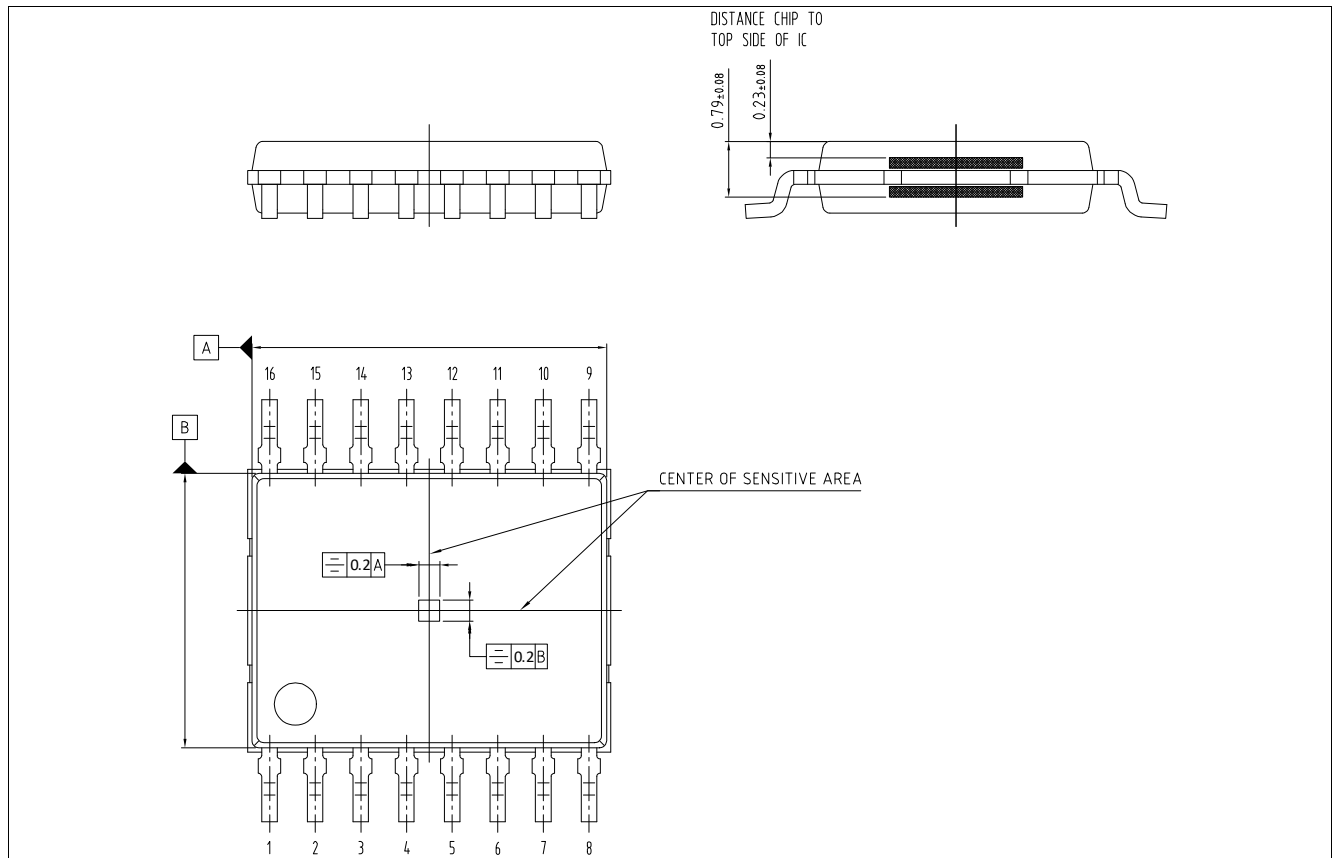

Figure 24 Position of sensing element

Note: **Figure 24** shows the positioning of the two sensor dies in the TLE5x09A16D. In the TLE5x09A16, only the top die is mounted.

Table 16 Sensor IC placement tolerances in package

Parameter	Values		Unit	Notes
	Min.	Max.		
Position eccentricity	-100	100	µm	In X- and Y-direction
Rotation	-3	3	°	Affects zero position offset of sensor
Tilt	-3	3	°	

Attention: The positioning accuracy of each sensor IC in the package is $\pm 3^\circ$. Thus, the relative rotation of the two sensor ICs can be up to 6° , resulting in a constant offset of the angle output of up to 6° . Additionally, the misalignment due to magnetization resulting in the orthogonality error (listed in [Table 9](#) and [Table 10](#)) has to be added to the overall angle offset, listed in [Table 5](#). With a GMR sensor the orthogonality error can be in worst case $\pm 12^\circ$ according to specification for each die. For AMR this effect is negligible. These effects have to be measured in an end-of-line calibration and taken into account during operation of the TLE5x09A16(D).

Package information

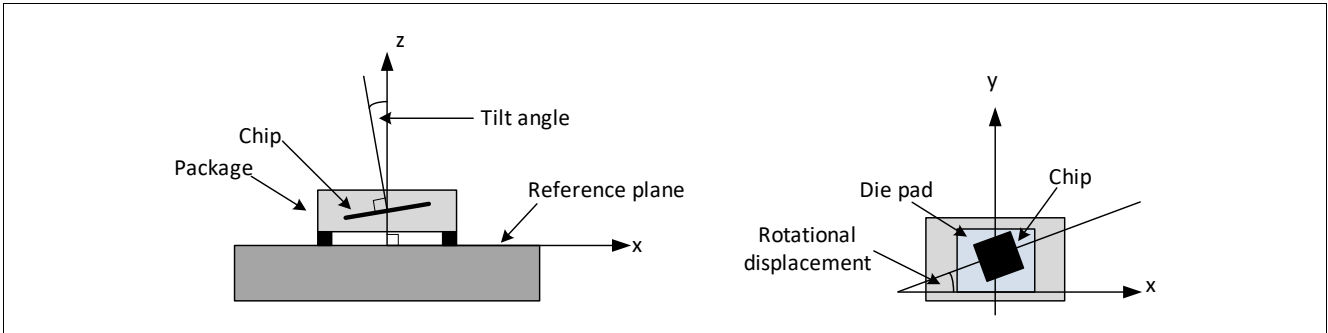

Figure 25 Tolerance of the die in the package

3.3 Footprint

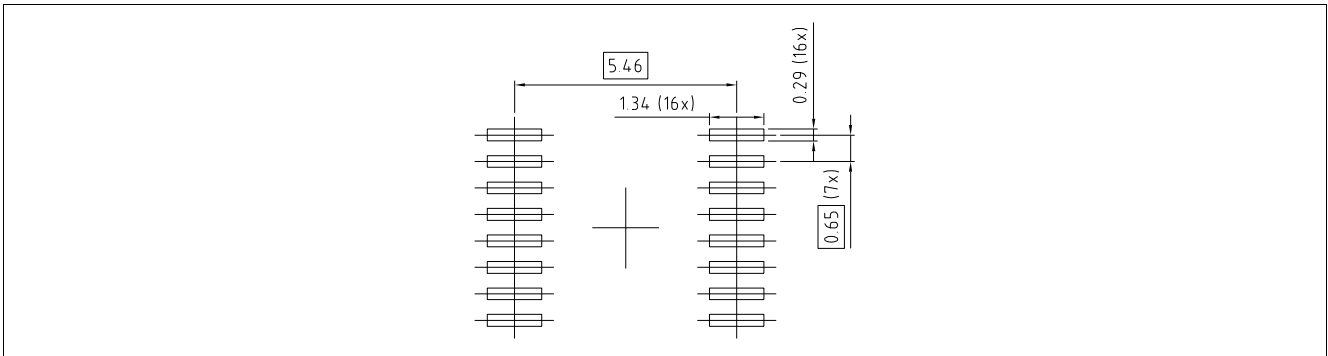

Figure 26 Footprint

3.4 Packing

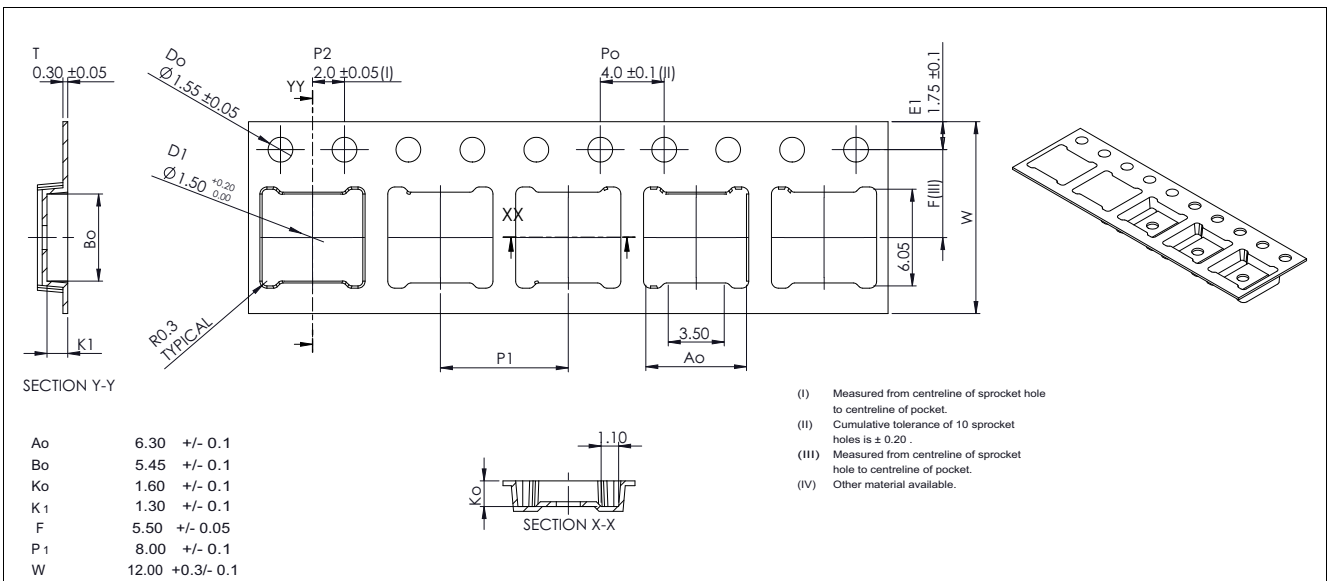

Figure 27 Tape and reel

Package information

3.5 Marking

The device is marked on the frontside with a date code, the device type and a lot code. On the backside there is a 8 x 18 data matrix code and an OCR-A code.

Position	Marking	Description
1st Line	Gxxxx	G = green, 4-digit = date code
2nd Line	309Dxxxx	Type (8 digits), see ordering Table 3
3rd Line	xxx	Lot code (3 digits)

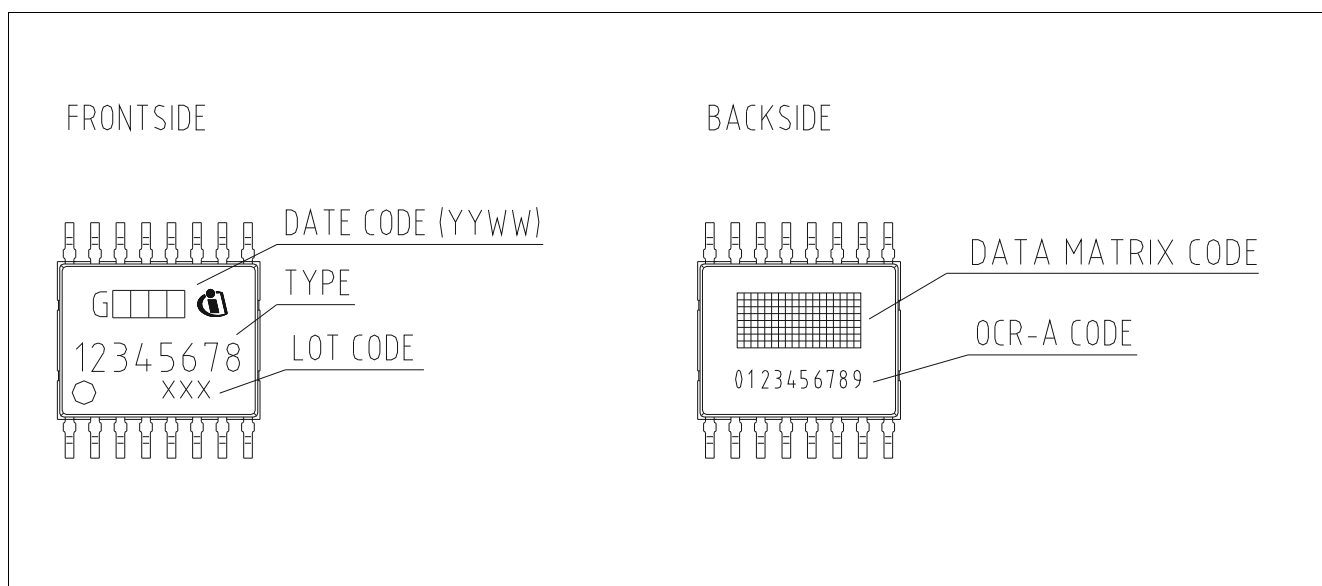

Figure 28 Marking

Revision history

4 Revision history

Revision	Date	Changes
1.0	2016-01	TLE5309D Initial release
1.0	2016-06	TLE5009A16D Initial release
1.1	2017-04	TLE5009A16(D) Table 1: single die types added. Table 2: single die pin description added. Chapter 3: Table 6 splitted in single-ended and differential output parameters, type description replaced by VDD value. Figure 8 added (Single-ended output signals). Table 8: single-ended fully compensated angle error added. Table 9: single-ended angle error added. Chapter 3: Typical behavior of angle error compensation added. Figure 13: Typical residual angle error for full and one-time compensation added. Chapter 3: ESD protection splitted in single and dual die. Figure 15 added (Marking). Layout changed.
1.2	2017-10	TLE5009A16(D) Chapter References removed. Table 2: Pin description changed. Figure 7: Application circuit in single-ended output mode added. Figure 9: Application circuit for partial diagnostics with pull-down resistors in single-ended output mode added. Figure 10: Application circuit for partial diagnostics with pull-down resistors in differential output mode added. Table 6: single-ended output noise changed.

Revision history

Revision	Date	Changes
1.1	2017-10	<p>TLE5309D</p> <p>Layout changed.</p> <p>Table 8: single-ended angle error added.</p> <p>Table 9: single-ended angle error added.</p> <p>Figure 19: Typical residual angle error for full and one-time compensation GMR sensor added.</p> <p>Figure 20: Typical residual angle error for full and one-time compensation AMR sensor added.</p> <p>Chapter References removed.</p> <p>Pin description: Symbol changed to Pin Name.</p> <p>Figure 9: Application circuit in single-ended output mode added.</p> <p>Figure 11: Application circuit in low-power applications in single-ended output mode added.</p> <p>Figure 13: Application circuit for partial diagnostics with pull-down resistors in single-ended output mode added.</p>
2.0	2018-12	<p>TLE5x09A16(D) family sensor datasheet released</p> <p>Changes TLE5009A16(D) rev. 1.2 to TLE5x09A16(D) rev. 2.0: Chapter 2.4 Error diagnosis: internal detectable errors removed. Table 9 differential mode: vector length removed. Figure 25: die displacement added.</p> <p>TLE5109A16(D) - initial release in TLE5x09A16(D) rev. 2.0</p> <p>Changes TLE5309D rev. 1.1 to TLE5x09A16(D) rev. 2.0: Table 6: Magnetic induction AMR added. Chapter 2.4 Error diagnosis: internal detectable errors removed. Table 8 single-ended: AMR synchronism to +/- 6 % changed. Table 9 differential mode: AMR synchronism to +/- 6 % changed. Table 9 differential mode: vector length removed. Table 10: footnote angle error adder at low magnetic field for AMR added. Table 11: footnote angle error adder at low magnetic field for AMR added. Table 11: AMR single-ended one-time calibrated angle error improved. Figure 25: die displacement added.</p>

Trademarks of Infineon Technologies AG

μ HVIC™, μ IPM™, μ PFC™, AU-ConvertIR™, AURIX™, C166™, CanPAK™, CIPOS™, CIPURSE™, CoolDP™, CoolGaN™, COOLiR™, CoolMOS™, CoolSET™, CoolSiC™, DAVE™, DI-POL™, DirectFET™, DrBlade™, EasyPIM™, EconoBRIDGE™, EconoDUAL™, EconoPACK™, EconoPIM™, EiceDRIVER™, eupec™, FCOS™, GaNpowIR™, HEXFET™, HITFET™, HybridPACK™, iMOTION™, IRAM™, ISOFACE™, IsoPACK™, LEDriviR™, LITIX™, MIPAQ™, ModSTACK™, my-d™, NovalithIC™, OPTIGA™, OptiMOS™, ORIGA™, PowIRaudio™, PowIRstage™, PrimePACK™, PrimeSTACK™, PROFET™, PRO-SIL™, RASIC™, REAL3™, SmartLEWIS™, SOLID FLASH™, SPOC™, StrongIRFET™, SupIRBuck™, TEMPFET™, TRENCHSTOP™, TriCore™, UHVIC™, XHP™, XMC™.

Trademarks updated November 2015

Other Trademarks

All referenced product or service names and trademarks are the property of their respective owners.

Edition 2018-12

Published by

Infineon Technologies AG

81726 Munich, Germany

© 2018 Infineon Technologies AG.

All Rights Reserved.

Do you have a question about any aspect of this document?

Email: erratum@infineon.com

IMPORTANT NOTICE

The information given in this document shall in no event be regarded as a guarantee of conditions or characteristics ("Beschaffheitsgarantie").

With respect to any examples, hints or any typical values stated herein and/or any information regarding the application of the product, Infineon Technologies hereby disclaims any and all warranties and liabilities of any kind, including without limitation warranties of non-infringement of intellectual property rights of any third party.

In addition, any information given in this document is subject to customer's compliance with its obligations stated in this document and any applicable legal requirements, norms and standards concerning customer's products and any use of the product of Infineon Technologies in customer's applications.

The data contained in this document is exclusively intended for technically trained staff. It is the responsibility of customer's technical departments to evaluate the suitability of the product for the intended application and the completeness of the product information given in this document with respect to such application.

For further information on technology, delivery terms and conditions and prices, please contact the nearest Infineon Technologies Office (www.infineon.com).

WARNINGS

Due to technical requirements products may contain dangerous substances. For information on the types in question please contact your nearest Infineon Technologies office.

Except as otherwise explicitly approved by Infineon Technologies in a written document signed by authorized representatives of Infineon Technologies, Infineon Technologies' products may not be used in any applications where a failure of the product or any consequences of the use thereof can reasonably be expected to result in personal injury.

X-ON Electronics

Largest Supplier of Electrical and Electronic Components

Click to view similar products for [Board Mount Hall Effect/Magnetic Sensors](#) category:

Click to view products by [Infineon](#) manufacturer:

Other Similar products are found below :

[HGPRDT005A](#) [AH277AZ4-AG1](#) [AV-10448](#) [HMC1041Z-TR](#) [SS41C](#) [TLE4917](#) [TLE4946-1L](#) [50017859-003](#) [TY-13101](#) [TLE4976L](#)
[SS85CA](#) [BU52002GUL-E2](#) [BU52003GUL-E2](#) [AH277AZ4-BG1](#) [TLE49614MXTSA1](#) [AH3376-P-B](#) [TLE4941](#) [AH211Z4-AG1](#) [AH3360-](#)
[FT4-7](#) [TLE4941-1](#) [SS460S-100SAMPLE](#) [AH374-P-A](#) [SS460P-T2](#) [AH1913-W-7](#) [AH3373-P-B](#) [TLE9852QXXUMA1](#) [MA732GQ-Z](#)
[MA330GQ-Z](#) [S-57K1NBL2A-M3T2U](#) [S-57P1NBL9S-M3T4U](#) [S-576ZNL2B-L3T2U](#) [S-576ZNL2B-A6T8U](#) [S-57P1NBL0S-M3T4U](#) [S-](#)
[57A1NSL1A-M3T2U](#) [S-57K1RBL1A-M3T2U](#) [S-57P1NBH9S-M3T4U](#) [S-57P1NBH0S-M3T4U](#) [S-57A1NSH1A-M3T2U](#) [S-57A1NSH2A-](#)
[M3T2U](#) [S-57K1NBH1A-M3T2U](#) [S-57A1NNL1A-M3T2U](#) [S-5701BC10B-L3T2U5](#) [S-5701BC11B-L3T2U5](#) [S-57GNNL3S-A6T8U](#) [S-](#)
[57TZ1L1S-A6T8U](#) [S-57GSNL3S-A6T8U](#) [S-5716ANDH0-I4T1U](#) [S-57GSNL5S-L3T2U](#) [S-57GDNL3S-L3T2U](#) [S-57GNNL3S-L3T2U](#)