

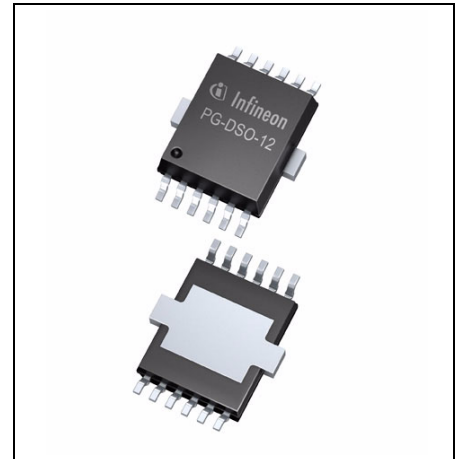

Features

- Dual output
5 V ($\pm 2\%$), 215mA and 2.6 V¹⁾ ($\pm 4\%$), 200mA or
5 V ($\pm 2\%$), 215mA and 3.3 V ($\pm 3\%$), 200mA
- Ultra low quiescent current consumption < 55 μ A
- Inhibit function
- Very low dropout voltage
- Reset with power-on delay
- Early Warning comparator
- Window watchdog
- Power sequencing for dual voltage μ C
- Output protected against short circuit
- Wide operation range: up to 45 V
- Wide temperature range: -40 °C to 150 °C
- Overtemperature protection
- Overload protection
- Green Product (RoHS compliant)
- AEC Qualified



Functional Description

The TLE 7469 is a monolithic integrated voltage regulator with two voltage outputs specially designed to supply microcontrollers with dual supply voltage: 2.6 V¹⁾ or 3.3 V core and 5 V I/O voltage like the Infineon XC164 and XC161.

1) 2.5 V nominal specification range of most μ Cs is compatible with the 2.6 V output voltage range of the TLE 7469.

Type	Package
TLE 7469 GV52	PG-DSO-12
TLE 7469 GV53	PG-DSO-12

The voltage regulator features an integrated reset circuitry which monitors the 2.6 V/ 3.3 V supply voltage. At power on the reset checks both supply voltages and performs the power-on reset with an adjustable delay time. The voltage difference is kept in the range $-0.5 \text{ V} < (V_{Q1} - V_{Q2}) < 3.0 \text{ V}$ even during power-on and power-down time enabling save μC operation without external clamping. Using the integrated early warning comparator an external voltage can be supervised. An integrated output sink current circuitry keeps the voltage at the Q1 pin below 5.5 V even when reverse currents are applied. Thus connected devices are protected from overvoltage damage. The regulator can be shut down via the Inhibit input causing the current consumption to drop below $9 \mu\text{A}$.

The TLE 7469 is designed for use under the severe conditions of automotive applications, and is therefore equipped with protection functions against overload, short circuit and overtemperature. It operates in the wide junction temperature range from $-40 \text{ }^\circ\text{C}$ to $150 \text{ }^\circ\text{C}$ and offers the low quiescent current consumption required for body applications.

For applications requiring extremely low noise levels the Infineon voltage regulator family TLE 42XY and TLE 44XY is more suited than the TLE 7469. A mV-range output noise on the TLE 7469 caused by the charge pump operation is unavoidable due to the ultra low quiescent current concept.

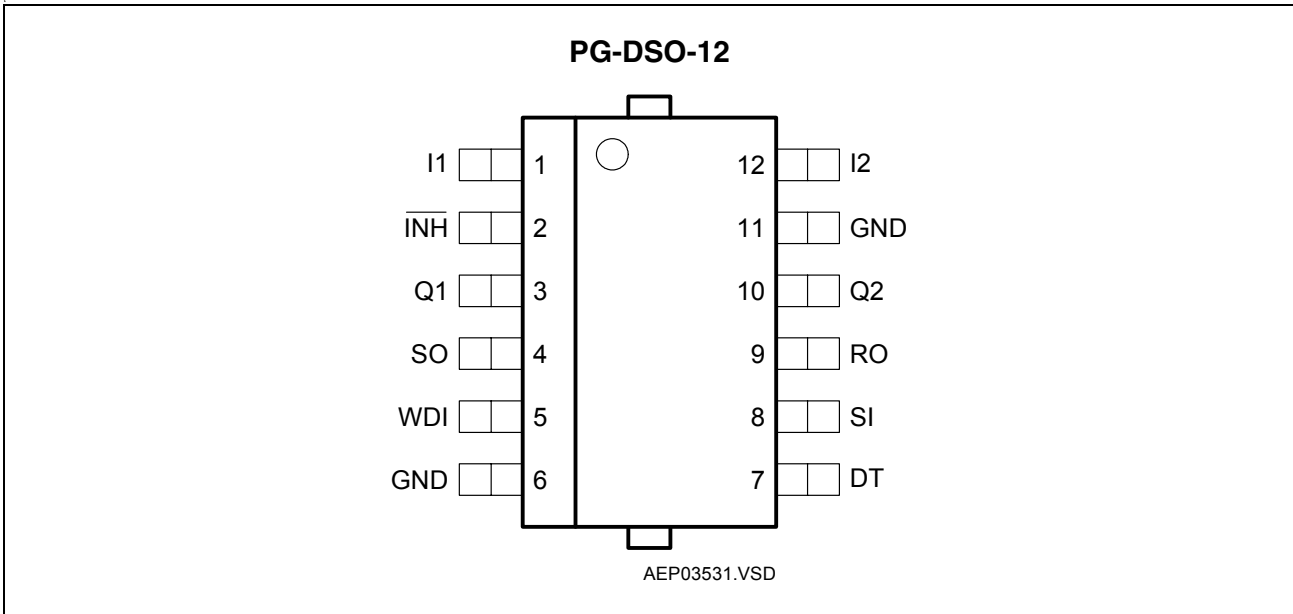

Figure 2 Pin Configuration (top view)

Table 1 Pin Definitions and Functions

Pin No.	Symb.	Function
1	I1	Input voltage 1 ; block to ground directly at the IC with a 100 nF ceramic capacitor
2	$\overline{\text{INH}}$	Inhibit Input ; low level disables the IC. Integrated pull-down resistor
3	Q1	Output voltage 1 ; 5.0 V, block to GND with a capacitor $C_{Q1} \geq 1 \mu\text{F}$, ESR < 6 Ω at 10 kHz
4	SO	Sense output ; Output of Early Warning Comparator, open collector output
5	WDI	Watchdog Input ; Trigger Input for Watchdog pulses
6, 11	GND	Ground ; Pin 6, 11 and heat slug must be connected to GND
7	DT	DT Delay timing ; connect to GND, Q1 or Q2 to select Reset and Watchdog timing
8	SI	Sense input ; Input for Early Warning comparator
9	RO	Reset output ; open collector output with integrated 20 k Ω pull-up resistor
10	Q2	Output voltage 2 ; 2.6 V (TLE 7469 GV52), 3.3 V (TLE 7469 GV53); block to GND with a capacitor $C_{Q2} \geq 1 \mu\text{F}$, ESR < 6 Ω at 10 kHz
12	I2	Input voltage 2 ; block to ground directly at the IC with a 100 nF ceramic capacitor

Table 2 Absolute Maximum Ratings
 $-40\text{ °C} < T_j < 150\text{ °C}$

Parameter	Symbol	Limit Values		Unit	Remarks
		Min.	Max.		
Input I1					
Voltage	V_{I1}	-0.3	45	V	–
Current	I_{I1}	–	–	mA	Internally limited
Input I2					
Voltage	V_{I2}	-0.3	45	V	–
Current	I_{I2}	–	–	mA	Internally limited
Output Q1					
Voltage	V_{Q1}	-0.3	5.5	V	Permanent
Voltage	V_{Q1}	-0.3	6.2	V	$t < 10\text{ s}^1)$
Current	I_{Q1}	–	2	mA	Internally limited
Output Q2					
Voltage	V_{Q2}	-0.3	5.5	V	Permanent
Voltage	V_{Q2}	-0.3	6.2	V	$t < 10\text{ s}^1)$
Current	I_{Q2}	–	–	mA	Internally limited
Inhibit Input $\overline{\text{INH}}$					
Voltage	$V_{\overline{\text{INH}}}$	-0.3	45	V	Observe current limit $I_{\overline{\text{INHmax}}}^2)$
Current	$I_{\overline{\text{INH}}}$	-1	1	mA	–
Reset Output RO					
Voltage	V_{RO}	-0.3	5.5	V	Permanent
Voltage	V_{RO}	-0.3	6.2	V	$t < 10\text{ s}^1)$
Current	I_{RO}	–	–	mA	internally limited
Delay Timing DT					
Voltage	V_{DT}	-0.3	5.5	V	Permanent
Voltage	V_{DT}	-0.3	6.2	V	$t < 10\text{ s}^1)$
Current	I_{DT}	-5	5	mA	–

Table 2 Absolute Maximum Ratings (cont'd)
 $-40\text{ °C} < T_j < 150\text{ °C}$

Parameter	Symbol	Limit Values		Unit	Remarks
		Min.	Max.		
Watchdog Input WDI					
Voltage	V_{WDI}	-0.3	5.5	V	Permanent
Voltage	V_{WDI}	-0.3	6.2	V	$t < 10\text{ s}^{1)}$
Current	I_{WDI}	–	–	mA	internally limited
Sense Input SI					
Voltage	V_{SI}	-0.3	45	V	Observe current limit $I_{\text{SImax}}^{2)}$
Current	I_{SI}	-1	1	mA	–
Sense Output SO					
Voltage	V_{SO}	-0.3	5.5	V	Permanent
Voltage	V_{SO}	-0.3	6.2	V	$t < 10\text{ s}^{1)}$
Current	I_{SO}	–	–	mA	internally limited
Temperatures					
Junction temperature	T_j	–	150	°C	–
Storage temperature	T_{stg}	-50	150	°C	–

1) Exposure to these absolute maximum ratings for extended periods ($t > 10\text{ s}$) may affect device reliability.

2) External resistor required to keep current below absolute maximum rating when voltages $\geq 5.5\text{ V}$ are applied.

Note: Maximum ratings are absolute ratings; exceeding any one of these values may cause irreversible damage to the integrated circuit. Integrated protection functions are designed to prevent IC destruction under fault conditions. Fault conditions are considered as outside normal operating range. Protections functions are not designed for continuous repetitive operation.

Table 3 Operating Range

Parameter	Symbol	Limit Values		Unit	Remarks
		Min.	Max.		
Input voltage	V_{I1}	5.6	45	V	–
Input voltage	V_{I2}	6.0	45	V	$V_{I1} > 8V$
Input voltage	V_{I2}	4.2	45	V	$V_{I1} < 8V$
Junction temperature	T_j	-40	150	°C	–

Thermal Resistances PG-DSO-12

Junction case	R_{thjc}	–	4.4	K/W	–
Junction ambient	R_{thj-a}	–	107	K/W	PCB, only Footprint ¹⁾
Junction ambient	R_{thj-a}	–	58	K/W	PCB Heat Sink Area 300 mm ² ¹⁾
Junction ambient	R_{thj-a}	–	48	K/W	PCB Heat Sink Area 600 mm ² ¹⁾

1) Package mounted on PCB 80 × 80 × 1.5 mm³; 35μ Cu; 5μ Sn; zero airflow; 85 °C ambient temperature.

Note: In the operating range the functions given in the circuit description are fulfilled.

Table 4 Electrical Characteristics
 $V_{I1} = 13.5 \text{ V}; V_{I2} = 13.5 \text{ V}; -40 \text{ }^\circ\text{C} < T_j < 150 \text{ }^\circ\text{C};$ unless otherwise specified

Parameter	Symbol	Limit Values			Unit	Test Condition
		Min.	Typ.	Max.		
Output Q1						
Output voltage	V_{Q1}	4.90	5.0	5.10	V	$1 \text{ mA} < I_{Q1} < 215 \text{ mA},$ $6 \text{ V} < V_{I1} < 16 \text{ V}$
Output current limitation	I_{Q1}	320	–	700	mA	$V_{Q1} = 4.0 \text{ V}$
Output drop voltage; $V_{DRQ1} = V_{I1} - V_{Q1}$	V_{DRQ1}	–	300	600	mV	$I_{Q1} = 215 \text{ mA}^{1)}$
Load regulation	$\Delta V_{Q1,Lo}$	–	25	60	mV	$1 \text{ mA} < I_{Q1} < 215 \text{ mA}$
Line regulation	$\Delta V_{Q1,Li}$	–	20	50	mV	$I_{Q1} = 1 \text{ mA},$ $10 \text{ V} < V_I < 28 \text{ V}$
Power Supply Ripple Rejection	$PSRR$	–	60	–	dB	$f_r = 100 \text{ Hz},$ $V_r = 1 \text{ Vpp}$
Reverse Output Current Protection	$V_{Q,REV}$	–	–	5.5	V	$I_{Q,REV} = 1 \text{ mA},$ $V_{INH} = 0 \text{ V}$
Output Q2						
Output voltage	V_{Q2}	2.50	2.60	2.70	V	$1 \text{ mA} < I_{Q2} < 200 \text{ mA},$ $6 \text{ V} < V_{I2} < 16 \text{ V},$ TLE 7469 GV52
Output voltage	V_{Q2}	3.20	3.30	3.40	V	$1 \text{ mA} < I_{Q2} < 200 \text{ mA},$ $6 \text{ V} < V_{I2} < 16 \text{ V},$ TLE 7469 GV53
Absolute differential voltage	$V_{Q1} - V_{Q2}$	-0.5	–	3.0	V	$V_{Q1}, V_{Q2} > 1 \text{ V}$
Output current limitation	I_{Q2}	300	–	550	mA	$V_{Q2} = 2.0 \text{ V}$
Load regulation	$\Delta V_{Q2,Lo}$	–	25	60	mV	$1 \text{ mA} < I_{Q2} < 200 \text{ mA}$
Line regulation	$\Delta V_{Q2,Li}$	–	20	50	mV	$I_{Q2} = 1 \text{ mA},$ $10 \text{ V} < V_I < 28 \text{ V}$
Power Supply Ripple Rejection	$PSRR$	–	60	–	dB	$f_r = 100 \text{ Hz},$ $V_r = 1 \text{ Vpp}$

Table 4 Electrical Characteristics (cont'd)
 $V_{I1} = 13.5 \text{ V}; V_{I2} = 13.5 \text{ V}; -40 \text{ }^\circ\text{C} < T_j < 150 \text{ }^\circ\text{C};$ unless otherwise specified

Parameter	Symbol	Limit Values			Unit	Test Condition
		Min.	Typ.	Max.		
Current Consumption						
Quiescent current; $I_q = I_{I1} + I_{I2} - I_{Q1} - I_{Q2}$	I_q	–	–	55	μA	$I_{Q2} = I_{Q1} = 100 \mu\text{A},$ $T_j < 80 \text{ }^\circ\text{C}$
Quiescent current; inhibited	I_q	–	5	9	μA	$V_{\overline{\text{INH}}} = 0 \text{ V},$ $T_j < 80 \text{ }^\circ\text{C}$
Inhibit Input $\overline{\text{INH}}$						
Turn-on Voltage	$V_{\overline{\text{INH ON}}}$	–	–	3.1	V	$V_{Q1} \text{ \& } V_{Q2} \text{ on}$
Turn-off Voltage	$V_{\overline{\text{INH OFF}}}$	0.8	–	–	V	$V_{Q1} \text{ \& } V_{Q2} \text{ off}$
H-input current	$I_{\overline{\text{INH ON}}}$	–	3	4	μA	$V_{\overline{\text{INH}}} = 5 \text{ V}$
L-input current	$I_{\overline{\text{INH OFF}}}$	–	0.5	1	μA	$V_{\overline{\text{INH}}} = 0 \text{ V}, T_j < 80 \text{ }^\circ\text{C}$
Delay Timing DT						
Threshold Fast Timing Select	$V_{\text{DT,FAST}}$	4.5	–	–	V	–
Threshold Slow Timing Select	$V_{\text{DT,SLOW}}$	2.3	–	3.3	V	TLE 7469 GV52
Threshold Slow Timing Select	$V_{\text{DT,SLOW}}$	2.3	–	3.6	V	TLE 7469 GV53
Threshold Watchdog Turn Off ²⁾	$V_{\text{DT,OFF}}$	–	–	0.8	V	–
Watchdog Input WDI						
H-input voltage threshold	V_{WDIH}	–	–	3.0	V	–
L-input voltage threshold	V_{WDIL}	–	–	0.8	V	–
Watchdog sampling time	t_{sam}	0.20	0.25	0.30	ms	Fast Timing
		0.80	1.00	1.20	ms	Slow Timing
Ignore window time	t_{OW}	25.6	32.0	38.4	ms	Fast Timing
		102	128	154	ms	Slow Timing
Open window time	t_{OW}	25.6	32.0	38.4	ms	Fast Timing
		102	128	154	ms	Slow Timing

Table 4 Electrical Characteristics (cont'd)
 $V_{I1} = 13.5 \text{ V}; V_{I2} = 13.5 \text{ V}; -40 \text{ }^\circ\text{C} < T_j < 150 \text{ }^\circ\text{C};$ unless otherwise specified

Parameter	Symbol	Limit Values			Unit	Test Condition
		Min.	Typ.	Max.		
Closed window time	t_{CW}	25.6	32.0	38.4	ms	Fast Timing
		102	128	154	ms	Slow Timing
Window watchdog trigger time	t_{WD}	39.0	44.8	50.6	ms	Fast Timing
		156	179	202	ms	Slow Timing

Reset Output RO

Reset switching threshold 2	V_{RT2}	2.35	2.38	2.48	V	TLE 7469 GV52, V_{Q2} decreasing
Reset Headroom 2	V_{RH2}	130	190		mV	TLE 7469 GV52
Reset switching threshold 2	V_{RT2}	3.00	3.07	3.15	V	TLE 7469 GV53, V_{Q2} decreasing
Reset Headroom 2	V_{RH2}	165	240		mV	TLE 7469 GV53
Reset hysteresis 2	V_{RH2}	–	45	–	mV	TLE 7469 GV52 ³⁾
		–	60	–	mV	TLE 7469 GV53 ⁴⁾
Reset switching threshold 1	V_{RT1}	4.50	4.65	4.80	V	V_{Q1} decreasing
Reset hysteresis 1	V_{RH1}	–	90	–	mV	–
Reset sink current	I_{RO}	–	–	1	mA	$V_Q = 5 \text{ V}, V_{RO} = 0.5 \text{ V}$
Reset output low voltage	V_{ROL}	–	0.15	0.25	V	$V_{Q2} \geq 1 \text{ V}$
Reset high voltage	V_{ROH}	4.5	–	–	V	–
Integrated reset pull-up resistor	R_{RO}	10	20	40	k Ω	Internally connected to Q1
Power-up Reset delay time	T_{RD}	6.0	8.0	10.0	ms	Fast Timing ($V_{DT} \geq 4.5 \text{ V}$)
		24.0	32.0	40	ms	Slow Timing ($V_{DT} \leq 3.3 \text{ V}$)
Reset Reaction Time	T_{RR}	–	10	26	μs	–

Table 4 Electrical Characteristics (cont'd)
 $V_{I1} = 13.5 \text{ V}; V_{I2} = 13.5 \text{ V}; -40 \text{ }^\circ\text{C} < T_j < 150 \text{ }^\circ\text{C};$ unless otherwise specified

Parameter	Symbol	Limit Values			Unit	Test Condition
		Min.	Typ.	Max.		
Input Voltage Sense						
Sense threshold high	V_{SIH}	1.10	1.16	1.22	V	V_{SI} increasing (see Figure 4)
Sense threshold low	V_{SIL}	1.06	1.12	1.18	V	V_{SI} decreasing (see Figure 4)
Sense output low voltage	V_{SOL}	–	0.1	0.4	V	$V_{SI} < 1.01 \text{ V};$ $V_{I1} > 4.20 \text{ V};$ $I_{SO} = 0.5 \text{ mA}$
External SO pull-up resistor	$R_{SO \text{ ext}}$	9.2	–	–	k Ω	$V_{Q1} = 5\text{V}$
Sense input current	I_{SI}	-1	0.1	1	μA	$V_{SI} = 5 \text{ V}$
Sense high reaction time	$t_{pd \text{ SO LH}}$	–	4.0	–	μs	–
Sense low reaction time	$t_{pd \text{ SO HL}}$	–	4.0	–	μs	–

1) Measured when the output voltage has dropped 100 mV from the nominal Value obtained at $V_{I1} = 13.5 \text{ V}, V_{I2} = 13.5 \text{ V}.$

2) Watchdog off, Reset in slow mode.

3) Specified by design, not subject of production test.

4) Specified by design, not subject of production test.

Application Information

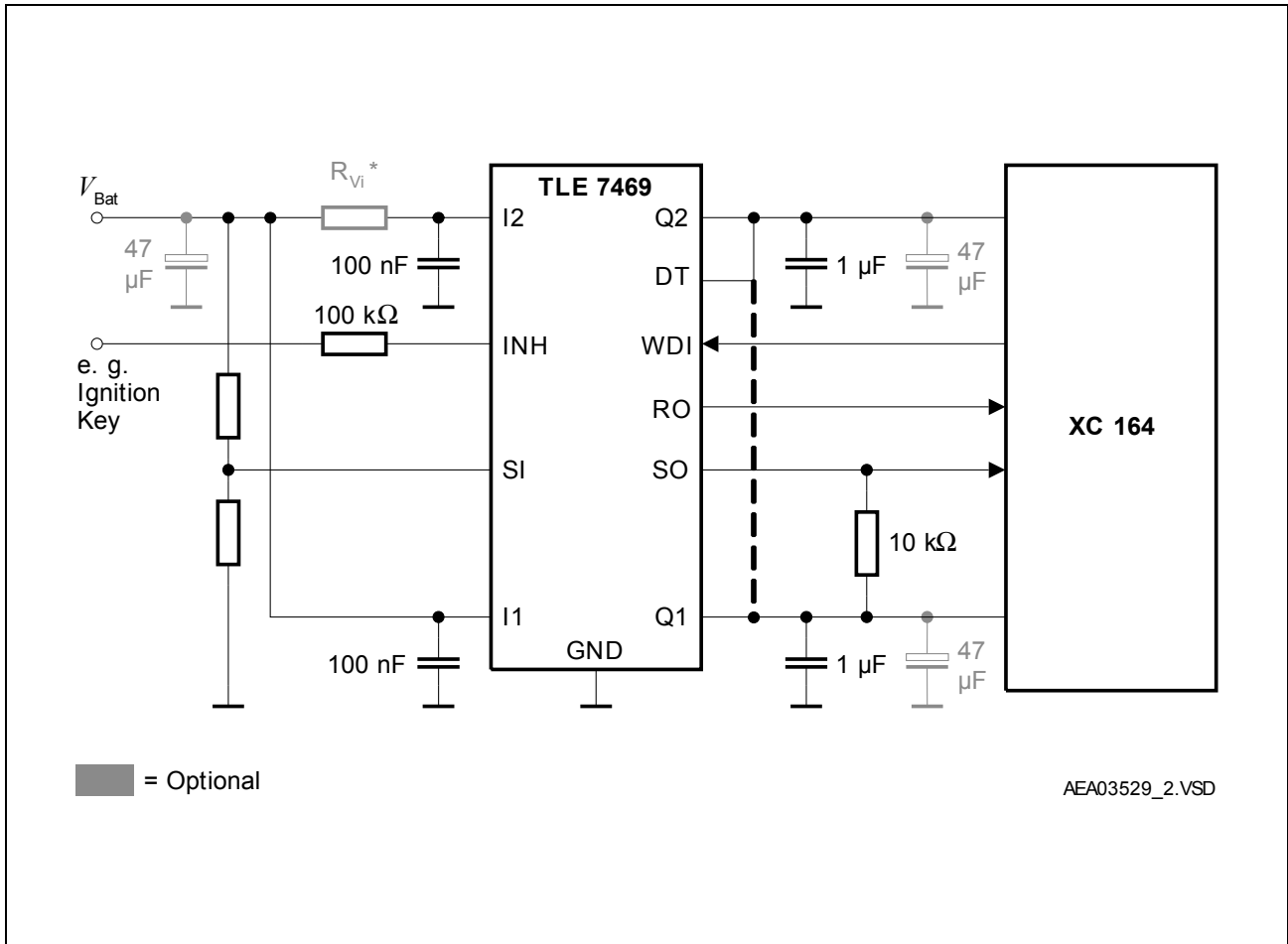

Figure 3 Application Diagram with Typical External Components

A typical application of the TLE 7469 is shown in [Figure 3](#). To prevent the regulation loop from oscillating a ceramic capacitor of $C_{Q1/2} \geq 1 \mu\text{F}$ is required at each of the outputs Q1 and Q2. In contrast to most low drop voltage regulators the TLE 7469 only needs moderate capacitance at the outputs and tolerates ceramic capacitors to keep the stability. This offers more design flexibility to the circuit designer enabling the IC also to operate without tantalum capacitors.

Additionally a buffer capacitor C_B of $> 10\mu\text{F}$ should be used for each output Q1 and Q2 to suppress influences from load surges to the voltage levels. This one can either be an aluminum electrolytic capacitor or a tantalum capacitor following the application requirements.

A general recommendation is to keep the drop over the equivalent serial resistor (ESR) together with the discharge of the blocking capacitor below the Reset Headroom (e.g. min. 130mV for the 2.6V Output).

Since the regulator output current roughly rises linearly with time the discharge of the capacitor can be calculated as follows:

$$dV_{C_B} = dI_Q * dt / C_B$$

The drop across the ESR calculates as:

$$dV_{ESR} = dI * ESR$$

To prevent a reset the following relationship must be fulfilled:

$$dV_C + dV_{ESR} < V_{RH2} = 130mV$$

Example: Assuming a load current step of $dI_Q = 50mA$, a blocking capacitor of $C_Q = 22\mu F$ and a typical regulator reaction time under normal operating conditions of $dt \sim 25\mu s$ and for special dynamic load conditions, such as load step from very low base load, a reaction time of $dt \sim 75\mu s$.

$$dV_C = dI_Q * dt / C_B = 50mA * 25\mu s / 22\mu F = 54mV$$

So for the ESR we can allow

$$dV_{ESR} = V_{RH2} - dV_C = 130mV - 54mV = 76mV$$

The permissible ESR becomes:

$$ESR = dV_{ESR} / dI_Q = 76mV / 50mA = 1.52\Omega$$

During design-in of the TLE7469 product family, special care needs to be taken with regards to the regulators reaction time to sudden load current changes starting from very low pre-load as well as cyclic load changes. The application note "*TLE7x Voltage Regulators - Application Note about Transient Response at ultra low quiescent current Voltage Regulators*" (see 3_cip05405.pdf) gives important hints for successful design-in of the Voltage Regulators of the TLE7x family.

As a dual regulator the TLE 7469 for correct operation should be always supplied at both input pins I1 and I2 out of one voltage supply. The dual voltage regulator with both inputs accessible, offers the possibility to reduce the power dissipation in the package. This can be achieved by two different input voltages or a Drop Resistor* R_{Vi} (see [Figure 3](#)) at the input pin I2 for the 2.6V output. If one of this options is chosen, care should be taken, to apply the device as described under "Table 3: Operating Range".

The reset output RO features an integrated pull-up resistor. Thus it can be directly coupled to the microcontroller reset input.

The sense comparator output SO is an open collector. An appropriate external pull-up resistor is typ. 5.6 kΩ ... 47 kΩ, the minimum value of 5.6 kΩ being defined by the max. sink current capability of the SO output transistor. If the sense comparator is not used the pull-up resistor can be spared. In this case the SI pin should be directly connected to Q1 in order to keep the comparator inactive.

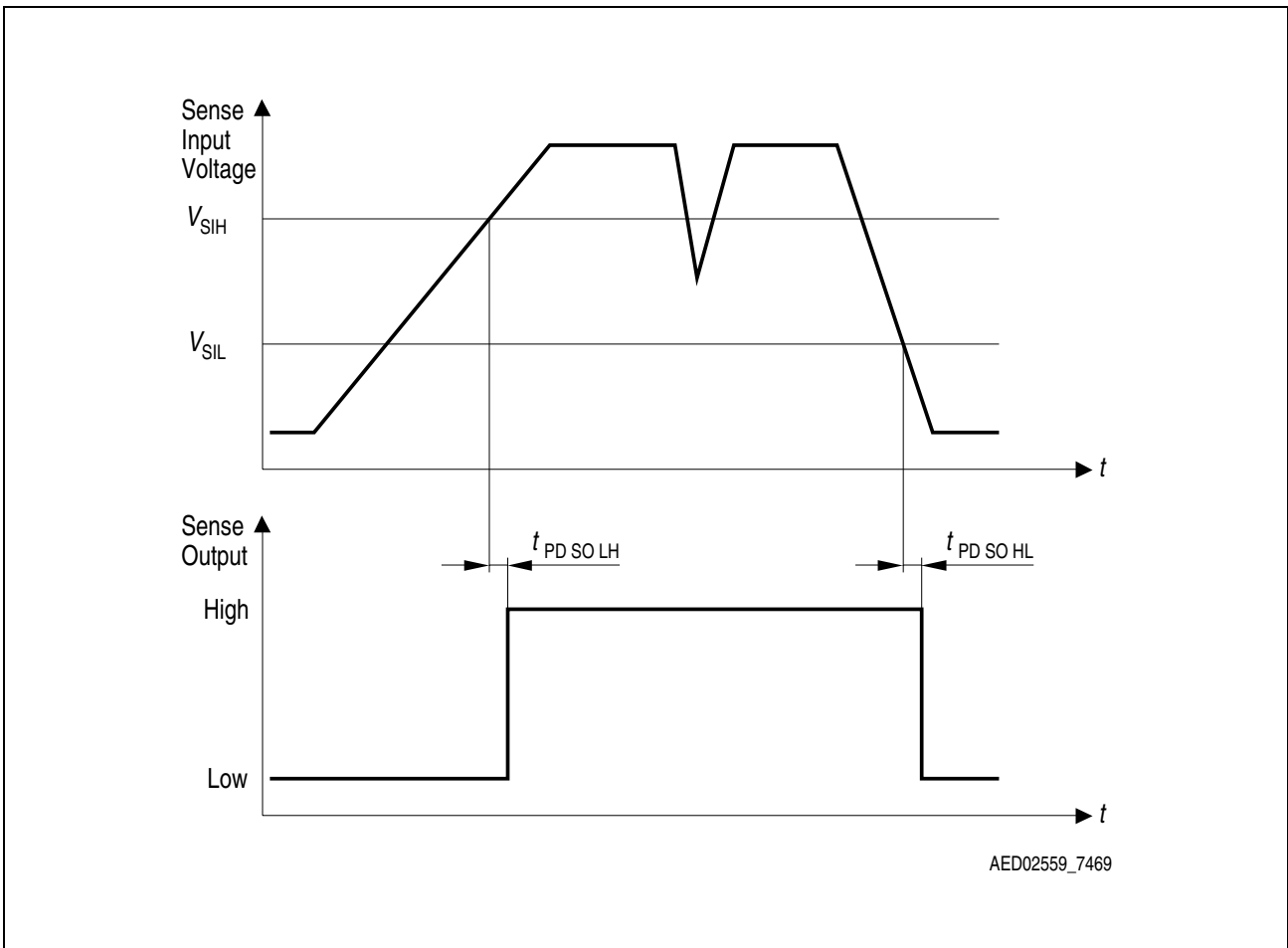

Figure 4 Sense Timing Diagram

Circuit Description

Power On Reset

In order to avoid any system failure, a sequence of several conditions has to be passed. When the level of V_{Q2} reaches the reset threshold V_{RT} , the signal at RO remains LOW for the Power-up reset delay time T_{RD} . Then a second comparator checks whether $V_{Q1} \geq V_{RT1}$ and only if this test is passed the reset output is switched to HIGH. The Reset output is only released (set to High level) if both output voltages have passed their specific reset threshold $V_{RT1/2}$. The reset function and timing is illustrated in [Figure 5](#).

The reset reaction time T_{RR} avoids wrong triggering caused by short “glitches” on the V_{Q2} -line. For power-fail, in case of V_{Q2} or V_{Q1} power down ($V_{Q2} < V_{RT2}$ or $V_{Q1} < V_{RT1}$ for $t > T_{RR}$) a logic LOW signal is generated at the pin RO to reset an external microcontroller.

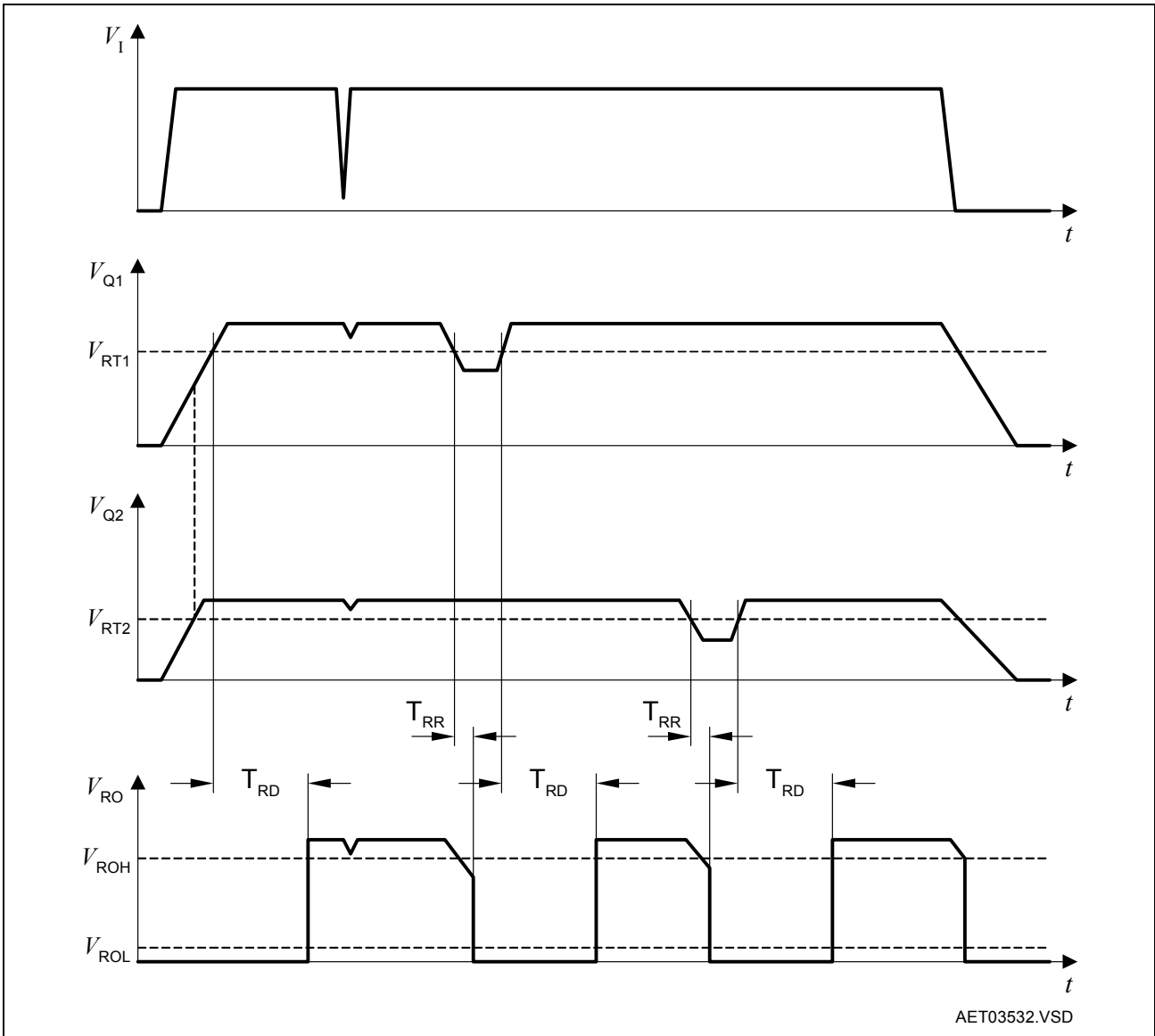

Figure 5 Reset Function and Timing Diagram

Watchdog Operation

The watchdog uses a fraction of the charge pump oscillator's clock signal as timebase. Connecting the DT pin to Q1 or to Q2 the watchdog timebase can be adjusted. The watchdog can be turned off by a low level ($V_{DT} \leq 0.8 \text{ V}$) applied to the DT pin. The timing values used in this text refer to typ. values with DT connected to Q1 (fast timing).

Figure 6 shows the state diagram of the window watchdog (WWD). After power-on, the reset output signal at the RO pin (microcontroller reset) is kept LOW for the reset delay time T_{RD} of typ. 8 ms. With the LOW to HIGH transition of the signal at RO the device starts the ignore window time t_{CW} (32 ms). During this window the signal at the WDI pin is ignored. Next the WWD starts the open window. When a valid trigger signal is detected during the open window a closed window is initialized immediately. A trigger signal within

the closed window is interpreted as a pretrigger failure and results in a reset. After the closed window the open window with the duration t_{OW} is started again. The open window lasts at minimum until the trigger process has occurred, at maximum t_{OW} is 32 ms (typ. value with fast timing).

A HIGH to LOW transition of the watchdog trigger signal on pin WDI is taken as a trigger. To avoid wrong triggering due to parasitic glitches two HIGH samples followed by two LOW samples (sample period t_{sam} typ. 0.25 ms) are decoded as a valid trigger (see [Figure 8](#)). A reset is generated (RO goes LOW) if there is no trigger pulse during the open window or if a pretrigger occurs during the closed window. The triggering is correct also, if the first three samples (two HIGH one LOW) of the trigger pulse at pin WDI are inside the closed window and only the fourth sample (the second LOW sample) is taken in the open window.

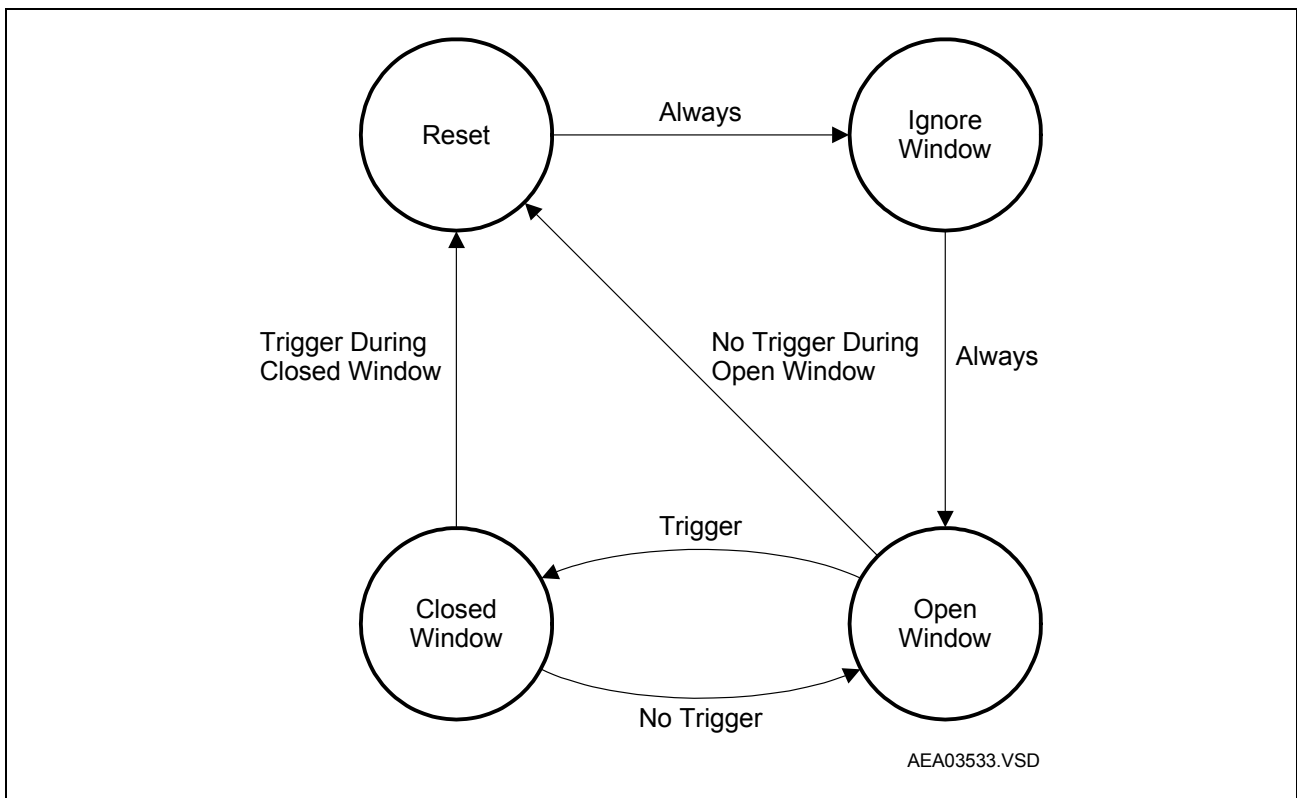

Figure 6 Window Watchdog State Diagram

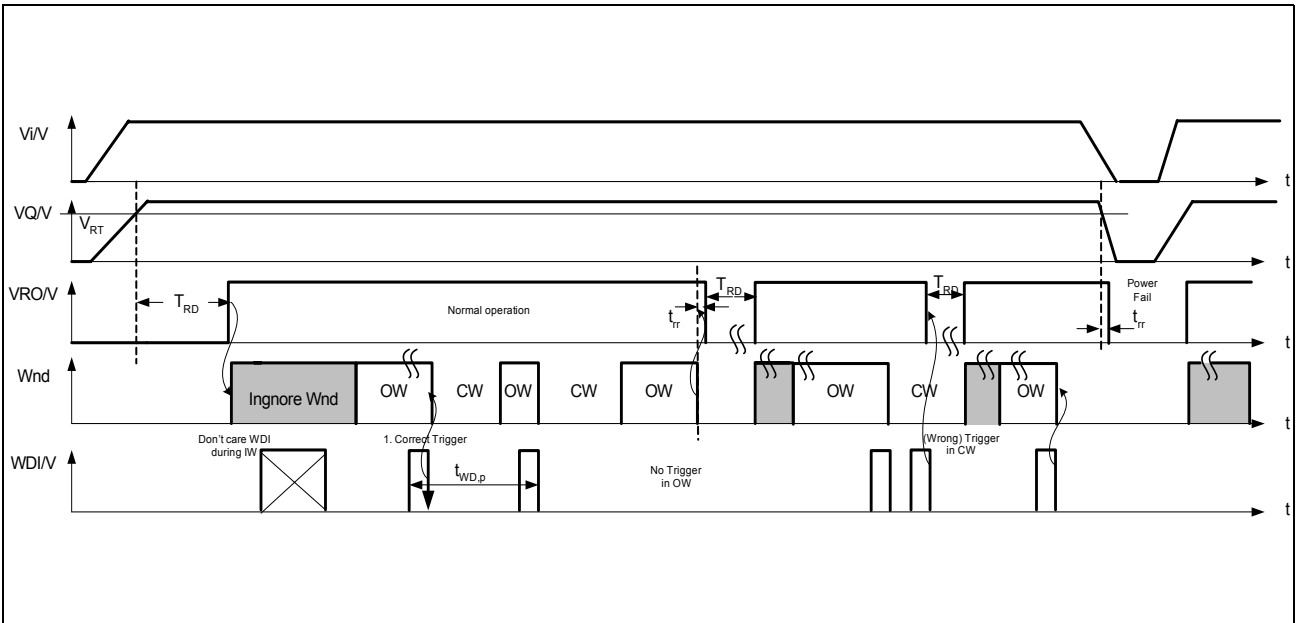

Figure 7 Window Watchdog Signal Flow

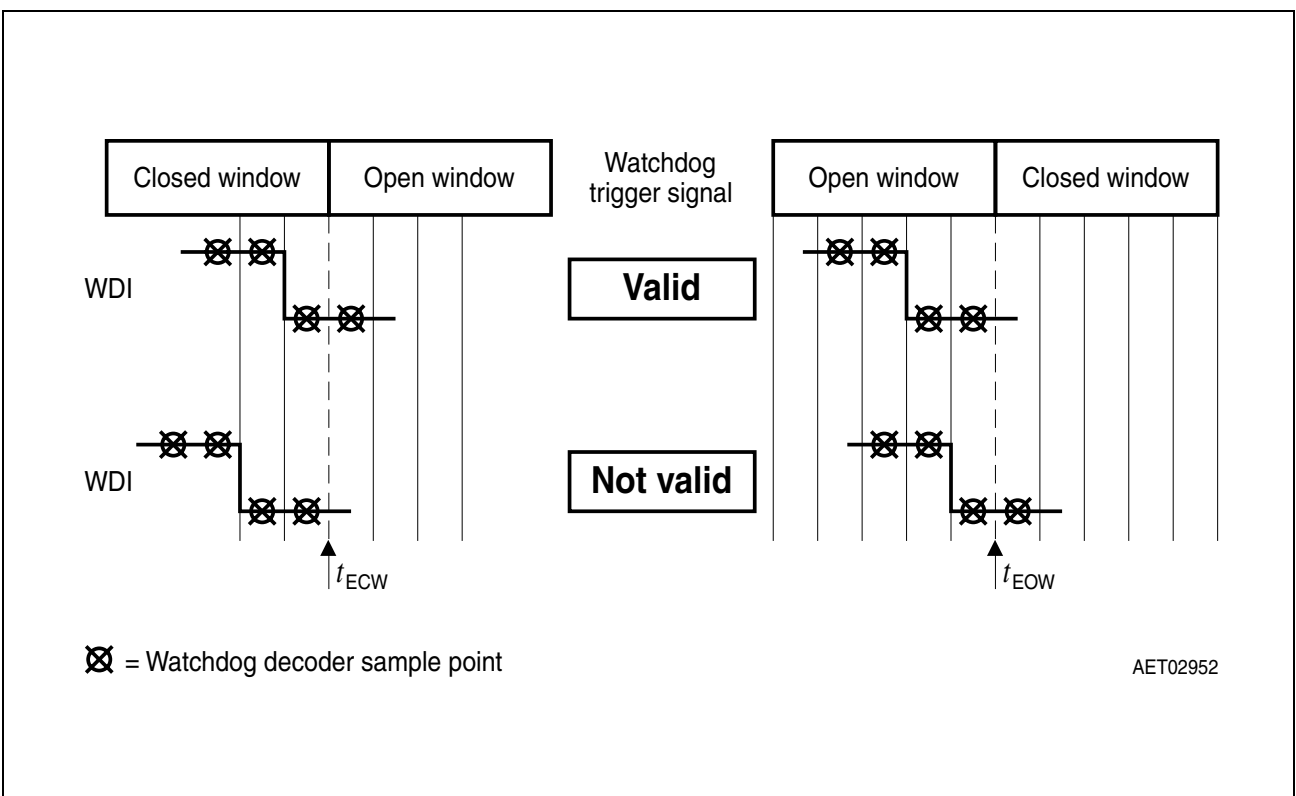

Figure 8 Window Watchdog Definitions

Revision History

Version	Date	Changes
Rev. 1.6	2008-01-22	Initial version of RoHS-compliant derivate of TLE 7469 Page 1 : AEC certified statement added. Page 1 and Page 19 : RoHS compliance statement and Green product feature added. Page 1 and Page 19 : Package changed to RoHS compliant version.
Rev. 1.5	2007-05-07	Modifications according to PCN No. 2007-070-A <ul style="list-style-type: none">• Page 8: Parameter “Output current limitation I_{Q2}” : Max. Value modified from 500mA to 550mA.• Page 3, Fig. 1 modified: RO pullup to Q1 instead to Q2.• Legal disclaimer updated.
Rev. 1.4	2005-07-15	Final Datasheet

Edition 2008-01-22

**Published by
Infineon Technologies AG
81726 Munich, Germany**

**© 2008 Infineon Technologies AG
All Rights Reserved.**

Legal Disclaimer

The information given in this document shall in no event be regarded as a guarantee of conditions or characteristics. With respect to any examples or hints given herein, any typical values stated herein and/or any information regarding the application of the device, Infineon Technologies hereby disclaims any and all warranties and liabilities of any kind, including without limitation, warranties of non-infringement of intellectual property rights of any third party.

Information

For further information on technology, delivery terms and conditions and prices, please contact the nearest Infineon Technologies Office (www.infineon.com).

Warnings

Due to technical requirements, components may contain dangerous substances. For information on the types in question, please contact the nearest Infineon Technologies Office.

Infineon Technologies components may be used in life-support devices or systems only with the express written approval of Infineon Technologies, if a failure of such components can reasonably be expected to cause the failure of that life-support device or system or to affect the safety or effectiveness of that device or system. Life support devices or systems are intended to be implanted in the human body or to support and/or maintain and sustain and/or protect human life. If they fail, it is reasonable to assume that the health of the user or other persons may be endangered.

X-ON Electronics

Largest Supplier of Electrical and Electronic Components

Click to view similar products for [LDO Voltage Regulators](#) category:

Click to view products by [Infineon](#) manufacturer:

Other Similar products are found below :

[AP7363-SP-13](#) [L79M05TL-E](#) [AP7362-HA-7](#) [PT7M8202B12TA5EX](#) [TCR3DF185,LM\(CT](#) [TCR3DF45,LM\(CT](#) [TLE4473G V52](#)
[NCP4687DH15T1G](#) [701326R](#) [AP7315-25W5-7](#) [AP2111H-1.2TRG1](#) [ZLDO1117QK50TC](#) [AZ1117ID-ADJTRG1](#) [TCR3DG12,LF](#) [MIC5514-](#)
[3.3YMT-T5](#) [SCD7912BTG](#) [NCP154MX180270TAG](#) [SCD33269T-5.0G](#) [NCP706ABMX300TAG](#) [NCP114BMX075TCG](#) [MC33269T-3.5G](#)
[TCR3DG33,LF](#) [TLE4471GXT](#) [TCR4DG35,LF](#) [TAR5S15U\(TE85L,F\)](#) [TCR3UG19A,LF](#) [TCR4DG105,LF](#) [MPQ2013AGG-5-P](#) [AP7315-](#)
[33SA-7](#) [TLE4268GSXUMA2](#) [NCP715SQ15T2G](#) [MIC5317-3.0YD5-T5](#) [NCV563SQ18T1G](#) [NCP715MX30TBG](#) [NCV8702MX25TCG](#)
[MIC5317-1.2YD5-T5](#) [AP2213D-3.3TRG1](#) [MIC5514-1.2YMT-T5](#) [NCV8170BMX280TCG](#) [AP2202K-2.6TRE1](#) [NCV8170AXV120T2G](#)
[NCV8170BMX300TCG](#) [NCV8152MX300180TCG](#) [NCP700CMT45TBG](#) [AP7315-33W5-7](#) [NCP154MX180300TAG](#) [TCR2DG13,LF](#)
[AP2113AMTR-G1](#) [TCR15AG12,LF](#) [TAR5S16U\(TE85L,F\)](#)