

TLE8881-2

Alternator Control IC with LIN Interface



Features

- Single-chip alternator control IC
- High-side n-channel DMOS output stage with $R_{\text{DS(on)}}$ of 60 m Ω typ. (at 25°C) / 110 m Ω max.
- Excitation PWM duty cycle range from 0% up to 100%
- Full digital and fast PI regulator
- EEPROM for customization to the target application
- Compliant to both communication standard specifications LIN 2.1 (on physical layer and data link layer) and LIN 1.3 (on data link layer) with baudrate up to 19200 bit/s - selectable via EEPROM
- Compatible to several OEM specification variants
- Digital temperature setpoint compensation
- Excitation current limitation depending on LIN commands
- Extensive voltage measurement range of 8 V up to 24 V
- Very low stand-by current of less than 80 μA @ 25°C
- High ESD resistivity of 8 kV on all lines (ESD HBM)
- High temperature range of -40°C up to 175°C
- Green product (RoHS-compliant)

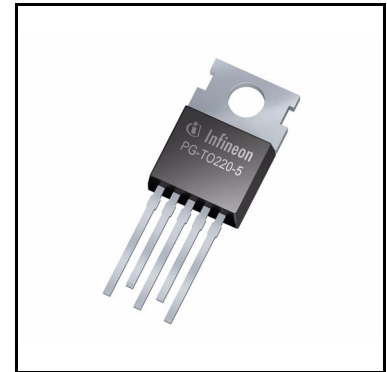

Potential applications

- Voltage regulator for externally excited alternator/generator machine

Product validation

Qualified for automotive applications. Product validation according to AEC-Q100.

Table 1 Product Variants

Type	Sales code	Package	Marking
TLE8881-2-CH	TLE8881-2-CH	Bare Die	n.a.
TLE8881-2-TN	TLE8881-2-TN	PG-TO-220-5-12 Straight Leads	TLE8881-2

Description

The device is based on Infineon's power technology SPT which allows bipolar and CMOS control circuitry to be integrated with DMOS power devices on the same monolithic circuitry.

The battery voltage is regulated at a precise value between 10.6 V and 16 V. In case of communication loss, the regulator is able to proceed with the voltage regulation by using adjustable default values. A fixed frequency PWM voltage is set at an output pin to excite the excitation coil of the alternator.

The TLE8881-2 is equipped with special protection circuitry as well as circuitry to control the excitation voltage slew rate to reduce EMI. Therefore the device meets the specific ESD and EMC requirement of the harsh automotive environment.

The following main features are implemented:

Closed loop voltage control

By controlling the excitation PWM duty cycle of the excitation output stage, the TLE8881-2 regulates the output voltage to an internal default voltage setpoint or to a voltage setpoint controlled by the engine management or energy management ECU via the LIN interface. The regulation is processed in a full digital and fast PI regulator.

Load Response Control (LRC)

The load response control (LRC) prevents engine speed hunting and vibration due to electrical loads which cause abrupt torque loading of the engine at low speeds.

Self start detection

The TLE8881-2 automatically wakes up the state machine if the frequency and amplitude of the phase signal is above a specific threshold. This allows the alternator to function in spite of interrupted or broken LIN communication.

Pre-excitation

The excitation coil is pre-energized with a small fixed excitation PWM duty cycle coming from the excitation output stage of the TLE8881-2 to provide a stable phase voltage input signal.

Phase Signal Boost (PSB)

The phase signal boost system of the TLE8881-2 maintains a proper phase signal for rotor speed measurement.

Low Voltage Excitation Switch On (LEO)

At very low battery voltage loading is immediately induced by increasing the current in the excitation coil until a minimal defined voltage is achieved.

High Voltage Excitation Switch Off (HEO)

At very high boardnet voltage, the excitation is immediately switched off in order to stop generating power.

Excitation current measurement

The measurement of the excitation current inside the rotor is used by the ECU to calculate and monitor the torque on the engine.

Excitation current limitation

The current limitation is used to set a boundary on the excitation current (meaning on the torque) via the LIN interface.

Frequency-dependent Excitation Current Limitation (FEXLIM)

The current limitation is used to set a boundary on the current (meaning on the torque) and is dependent on rotation speed.

Temperature measurement

The TLE8881-2 is able to send its own measured junction temperature to the ECU via the LIN interface.

Temperature setpoint compensation

The voltage setpoint is gradually compensated depending on the measured temperature.

Voltage measurement

The TLE8881-2 is able to send the measured voltage at VBA input via the LIN interface.

Speed measurement

The TLE8881-2 is able to send the measured rotor speed to the ECU via the LIN interface.

Speed-dependent Ki-Kp parameter sets (KiKp)

TLE8881-2 allows to use different regulation KiKp parameter sets for the regulation of the EXC duty cycle dependent on the rotation speed n_R of the alternator. The device provides 4 different but fixed KiKp parameter sets which can be selected.

F-para switching

The PI controller's parameter sets can be adjusted during operation. This function offers the possibility to adjust the parameters depending on the pre-programmed parameter set and the activation via a LIN frame.

Voltage-dependent KiKp function (VoKiKp function)

In order to avoid a slow reaction of the IC on relatively high VBA voltages compared to V_{SET} , especially if slow KiKp parameter sets are chosen, the TLE8881-2 offers a voltage dependent KiKp function (VoKiKp).

Speed-dependent Lowering of the HEO limit (LowHEO function)

In order to optimize the reaction to high VBA voltages in case of a low rotation speed, the TLE8881-2 offers a function to lower the HEO limit in order to assure a fast reaction to high VBA voltages.

LIN interface

In addition to the classical functions of voltage regulation, this regulator offers a bi-directional serial data interface which is fully compliant to the standard specification LIN 2.1 (on the physical layer and the data link layer) and LIN 1.3 (on the data link layer) for communication with the engine management or energy management ECU. A dedicated EEPROM switch provides the possibility to change between LIN 1.3 or LIN 2.1 on the data link layer.

This communication link offers the following functions:

- Control of the voltage setpoint as regulation input
- Control of the LRC parameters

- Control of the excitation current limitation
- Control of what regulation loop parameter set is used for optimized behavior with and without battery
- Control of the temperature voltage compensation offset
- Different frame configurations for VDA-A, VDA-B, OEM1, OEM2
- Transmission of the excitation PWM duty cycle value at excitation output stage to ECU
- Transmission of the excitation current value (determined by excitation current measurement) to ECU
- Transmission of the voltage at VBA (determined by voltage measurement) to ECU
- Transmission of the chip junction temperature to ECU
- Transmission of the rotation speed (using speed measurement) to ECU
- Transmission of the alternator's system supplier code to ECU
- Transmission of the alternator's class code to ECU
- Transmission of the regulator identification code to ECU
- Transmission of diagnosis (defects detection) to ECU: high temperature (F-HT), rotor failure (F-ROT), electrical failure (F-EL, debounced)
- Transmission of the LIN diagnosis: communication error failure (F-CEF), communication time-out (F-CTO)

Table of Contents

1	Block diagram	8
2	Pin and pad configuration	10
2.1	Pin assignment for PG-TO-220-5-12 package	10
3	General product characteristics	11
3.1	Absolute maximum ratings	11
3.2	Functional range	12
3.3	Thermal resistance	13
3.4	Reduced operating range	13
4	Main control block	14
4.1	State diagram	14
4.2	Rotational speed events	15
4.3	LIN communication events	16
4.4	State description	16
4.4.1	Feature priorities	16
4.4.2	“Stand-by”	17
4.4.3	State “ComActive”	18
4.4.4	State “pre-excitation”	19
4.4.5	State “normal operation”	19
4.4.6	State “excitation off”	20
4.4.7	State “default operation”	21
4.4.8	State “overtemperature”	21
4.5	Diagnostic flags	22
4.5.1	High-temperature diagnostic flag	23
4.5.2	Mechanical error flag	23
4.5.3	Electrical error flag	23
5	Regulation functions	26
5.1	Control system	26
5.2	Excitation output driver	27
5.3	Excitation current measurement	28
5.4	Limitation of Excitation Current (CLIM)	29
5.5	Temperature measurement	29
5.6	Temperature Setpoint Compensation (TSC)	30
5.7	Voltage measurement	31
5.8	Speed measurement	32
5.9	Low Voltage Excitation On (LEO)	32
5.10	High Voltage Excitation Off (HEO)	34
5.11	Phase Signal Boost (PSB)	36
5.12	Load Response Control (LRC)	36
5.13	Frequency-dependent Excitation Current Limitation (FEXLIM)	38
5.13.1	Parameters and limitation areas	39
5.13.2	Function activation/deactivation	39
5.13.3	FEXLIM vs. RCLIM register value	39
5.13.4	Transition behaviors	40
5.13.5	Function characteristics	40
5.13.6	Behavior with restore state function	41

5.14	Regulation parameters control via LIN (F-Para function)	42
5.15	Speed-dependent KiKp parameter sets (KiKp function)	42
5.16	Voltage-dependent KiKp function (VoKiKp function)	44
5.17	Speed-dependent lowering of the HEO limit (LowHEO function)	46
6	LIN interface	47
6.1	Bus topology	47
6.2	Signal specification (physical layer)	48
6.3	Message frames (data link layer)	51
6.3.1	LIN frame structure	52
6.3.2	LIN frame identifier recommendations	53
6.3.3	LIN RX frame	55
6.3.4	LIN TX1 frame	56
6.3.5	LIN TX2 frame	56
6.3.6	LIN TX3 frame	57
6.4	LIN registers	58
6.4.1	Register RVSET (voltage setpoint)	58
6.4.2	RVSET reporting via LIN	59
6.4.3	Registers LRC (load response control)	59
6.4.4	Register RCLIM (excitation current limitation)	62
6.4.5	Register RFPARA (F-Para function)	64
6.4.6	Register RHT (adjustment of high temperature threshold)	65
6.4.7	Register RDI (response data indicator)	65
6.4.8	Register RDC (excitation PWM duty cycle)	66
6.4.9	Register RMC (measured excitation current)	66
6.4.10	Register RMT (measured temperature on chip)	66
6.4.11	Register RMV (measured voltage at VBA terminal)	67
6.4.12	Register RMS (measured speed)	68
6.4.13	Register RSUPP and RCLASS	75
6.5	Default register content	75
6.6	Register output filters	77
6.6.1	Filter for excitation PWM duty cycle (RDC filter)	77
6.6.2	Filter for voltage measurement (RMV Filter)	78
6.6.3	Excitation current filter (RMC filter)	79
6.7	LIN 2.1 diagnostic frames	80
6.7.1	Node configuration / identification	80
6.7.2	NAD, supplier ID, function ID and variant	80
6.7.3	Assign frame ID range (LIN 2.1 service)	81
6.7.4	Read by identifier (LIN 2.1 service)	82
6.8	Programming Mode	82
6.9	Internal LIN timers	83
7	Phase monitoring block	84
7.1	Block diagram	84
7.2	Self-start wake-up	84
7.3	Speed detection	85
7.4	Phase monitoring	85
8	Core functions	86

8.1	Voltage reference	86
8.2	Internal supply reference	86
8.3	Oscillator	86
8.4	Charge pump	86
8.5	Restore state function	87
8.5.1	Supply micro-cut	87
8.5.2	Restore state event	88
9	Non-Volatile Memory (NVM)	89
9.1	NVM characteristics	89
9.2	NVM register description	90
9.2.1	List overview	90
9.2.2	Detailed description	94
10	Application information	112
10.1	EMC and ESD	113
10.2	Further application information	113
11	Package information	114
12	Revision history	115

Block diagram

1 Block diagram

The Alternator Control IC TLE8881-2 has a communication line to the ECU (LIN), 2 external alternator lines (VBA and GND) and 2 pins for the alternator-internal connections (EXC and PH). The device consists of several blocks to provide relating functions.

The device consists of 6 main function blocks as shown in **Figure 1**.

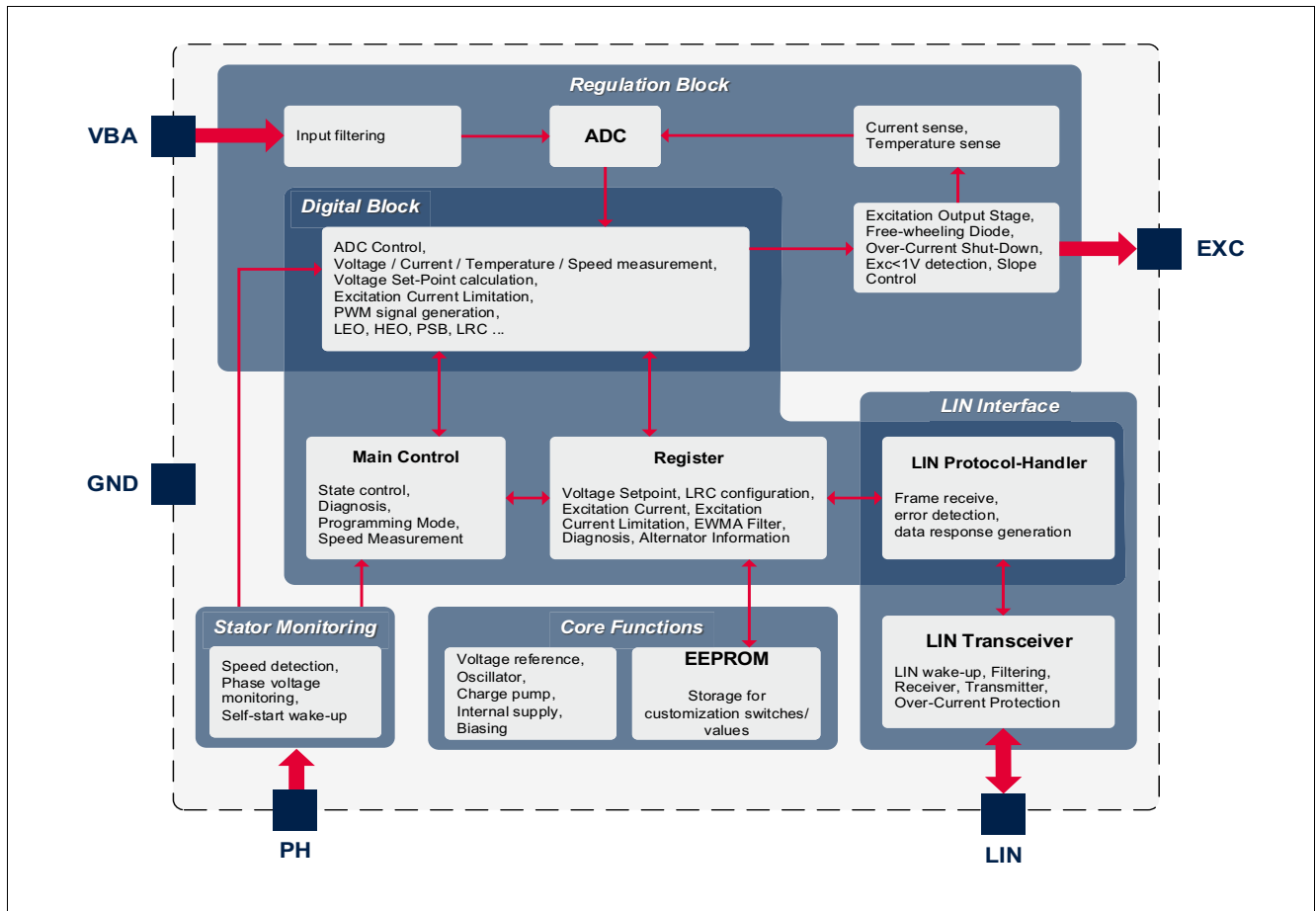

Figure 1 Block diagram

LIN interface

The TLE8881-2 is controlled and monitored by a communication master device using the standard LIN interface. Therefore, TLE8881-2 always behaves as a LIN slave device. All the information exchange with the ECU is done via the bi-directional one-wire LIN connection.

The LIN interface block is divided into two functional blocks: 1) the LIN transceiver which is used to handle the physical layer, and 2) the LIN protocol handler which is responsible for the data link layer processing. The LIN transceiver is also able to detect a LIN wake-up condition on the physical layer.

Stator monitoring

In the stator monitoring block, the frequency measurement for rotor speed information, phase wake-up, self start mechanism and the phase voltage measurement of the generator stator are processed.

Main control

The main control is the central logic of the system. Based on several parameters, this block determines in which state the system operates. Furthermore, this block is responsible for the system diagnosis.

Block diagram

Register

The TLE8881-2 configuration and monitoring information are stored in a set of internal registers. These registers can be set or read out via the LIN interface. Writable registers can be loaded either via LIN communication or via values stored in the EEPROM. In case of missing communication, a default setting is used by the TLE8881-2. Readable registers are loaded internally with its default values.

Regulation block

The excitation current in the rotor coil of the alternator which is adjusted by regulating the Excitation PWM Duty Cycle at the excitation output stage determines the field strength. The output voltage to the battery depends on the magnetic field strength and the rotor speed.

The battery voltage at the alternator (terminal VBA) is filtered and converted to a digital value. Also, the excitation current and the junction temperature are filtered and converted to a digital value. These digital values feed the digital regulator which is responsible for the voltage regulation, current limitation and LRC (load response control). The generated digital duty cycle value (0 to 100%) can be modified by the LEO and HEO functions to avoid low or high voltage conditions on the board net. The phase signal boost (PSB) function triggers high-side DMOS to quickly re-generate the phase signal output if the amplitude of the phase signal is not high enough. The excitation current limitation (CLIM) can apply a limitation of the excitation current. The frequency-dependent excitation current limitation (FEXLIM) can apply a limitation of the excitation current depending on the measured rotor speed.

An overcurrent detection and an overtemperature detection circuit switches the DMOS off to avoid destruction in case of an excitation pin shorted to ground or thermal overload.

Core functions and EEPROM

The core functions block consists of supporting circuitry such as the internal references, an oscillator, internal voltage supply, a charge pump for the high-side DMOS and the EEPROM (electrically erasable programmable read-only memory). The voltage reference for the output voltage regulation is generated within this block as well.

Pin and pad configuration

2 Pin and pad configuration

The Alternator Control IC TLE8881-2 is provided in industry standard PG-TO-220-5-12 Straight Leads package.

2.1 Pin assignment for PG-TO-220-5-12 package

Figure 2 shows the pin assignment for the PG-TO-220-5-12 Straight Leads package.

The related dimensions are provided in **Chapter 11**.

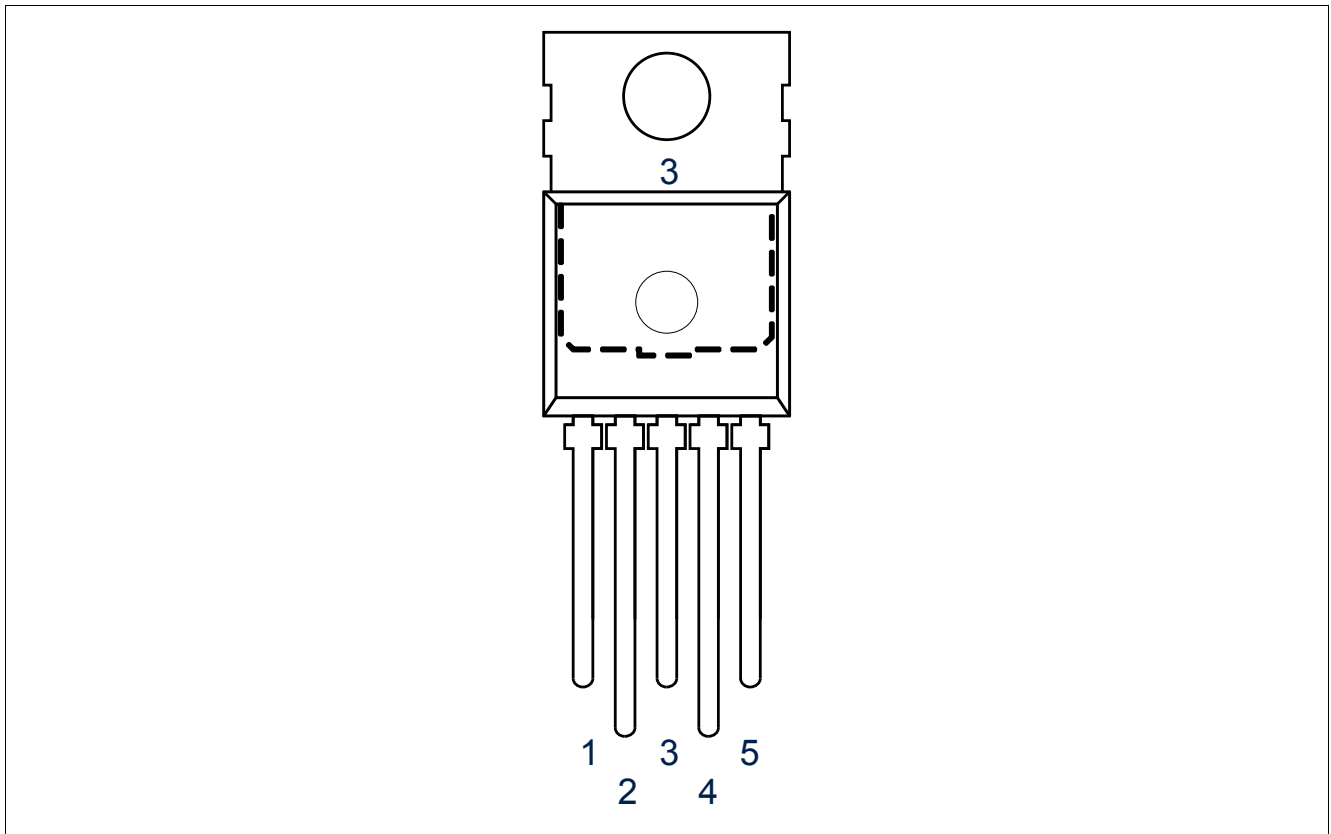

Figure 2 Pin configuration for PG-TO-220-5-12 Straight Leads

Table 2 Pin definitions and functions for PG-TO-220-5-12 Straight Leads

Pin	Symbol	Function
1	EXC	Excitation output; output to be connected with the excitation coil of the generator.
2	VBA	Supply voltage; connected to the battery
3	GND	Ground; signal ground
4	LIN	LIN; terminal of the LIN interface
5	PH	Phase input; to be connected with one of the phases of the generator
Cooling Tab	GND	Cooling tab; Internally connected to GND

General product characteristics

3 General product characteristics

3.1 Absolute maximum ratings

Table 3 Absolute maximum ratings¹⁾

All parameters are valid for: $-40^{\circ}\text{C} < T_J < 150^{\circ}\text{C}$; all voltages with respect to ground, positive current flowing into pin (unless otherwise specified):

Parameter	Symbol	Values			Unit	Note or Test Condition	Number
		Min.	Typ.	Max.			
Voltages							
Supply input voltage (battery and alternator voltage)	V_{BA}	-0.3	–	40	V	static	P_3.1.0.1
Supply input voltage (battery and alternator voltage)	V_{BA}	–	–	50	V	dynamic: pulse ISO 2 (ISO7637-2: 2004), clipped to 50 V;	P_3.1.0.2
Supply input voltage (battery and alternator voltage)	V_{BA}	-2.7	–	–	V	10 s; $T_J = 25^{\circ}\text{C}$; $R_{thJA} < 4 \text{ K/W}$	P_3.1.0.3
Phase input voltage	V_{PH}	-7.5	–	35	V	–	P_3.1.0.4
Voltage on excitation pin	V_{EXC}	-2.2	–	40	V	–	P_3.1.0.5
Voltage difference VBA - LIN pin	V_{LIN}	-40	–	40	V	–	P_3.1.0.6
Temperature							
Junction temperature	T_J	-40	–	175	$^{\circ}\text{C}$	–	P_3.1.0.7
Storage temperature	$T_{STORAGE}$	-45	–	150	$^{\circ}\text{C}$	–	P_3.1.0.8
ESD susceptibility							
ESD resistivity pin to GND	V_{ESD}	-8	–	8	kV	HBM according to ANSI/ESDA/JEDEC JS-001	P_3.1.0.9
ESD resistivity all pins	V_{ESD}	-2	–	2	kV	HBM according to ANSI/ESDA/JEDEC JS-001	P_3.1.0.10

1) Not subject to production test.

Notes

1. Stresses above the ones listed here may cause permanent damage to the device. Exposure to absolute maximum rating conditions for extended periods may affect device reliability.
2. Integrated protection functions are designed to prevent IC destruction under fault conditions described in the data sheet. Fault conditions are considered as “outside” normal operating range. Protection functions are not designed for continuous repetitive operation.

General product characteristics

3.2 Functional range

Table 4 Functional range

All parameters are valid for: $-40^{\circ}\text{C} < T_J < 150^{\circ}\text{C}$; $V_{BA} = 14.5\text{ V}$, unless otherwise specified:

Parameter	Symbol	Values			Unit	Note or Test Condition	Number
		Min.	Typ.	Max.			
Supply voltage for full operation	V_{BA}	6	–	18	V	For full operation; V_{BA} decreasing	P_3.2.0.1
Supply voltage for operation without LIN Communication	V_{BA}	5.5	–	18	V	V_{BA} decreasing	P_3.2.0.2
Supply voltage for jumpstart	V_{BA}	–	–	27	V	¹⁾ ; $T_J = 25^{\circ}\text{C}$	P_3.2.0.3
Supply voltage for reduced operation	V_{BA}	3.8	–	5.5	V	see Chapter 3.4 ¹⁾	P_3.2.0.4
Stand-by current	$I_{BA,standby}$	–	60	80	μA	$T_J = 25^{\circ}\text{C}$; $V_{BA} = 12.5\text{ V}$; $V_{PH} = 0\text{ V}$; EXC open circuit; $V_{LIN} = V_{BA}$	P_3.2.0.5
Current consumption in state “COM active”	I_{BA}	–	18	24	mA	$V_{BA} = 12.5\text{ V}$; $V_{PH} = 0\text{ V}$; EXC open circuit; $V_{LIN} = V_{BA}$ or LIN open circuit	P_3.2.0.6
Current consumption in state “normal operation”	I_{BA}	–	–	25	mA	$V_{BA} = 12.5\text{ V}$; EXC open circuit; $V_{LIN} = V_{BA}$ or LIN open circuit	P_3.2.0.7
Operation temperature	T_J	-40	–	150	$^{\circ}\text{C}$	–	P_3.2.0.8
Operation temperature	T_J	150	–	T_{SD}	$^{\circ}\text{C}$	¹⁾ ; fully functional. parameter deviations permissible.	P_3.2.0.9
Overtemperature shut-down threshold	T_{SD}	165	–	185	$^{\circ}\text{C}$	–	P_3.2.0.10
Time to initialize the system after power-up	$t_{power-up}$	–	–	10	ms	¹⁾	P_3.2.0.11

General product characteristics

Table 4 Functional range (cont'd)

All parameters are valid for: $-40^{\circ}\text{C} < T_J < 150^{\circ}\text{C}$; $V_{BA} = 14.5\text{ V}$, unless otherwise specified:

Parameter	Symbol	Values			Unit	Note or Test Condition	Number
		Min.	Typ.	Max.			
Time to exit mode "stand-by"	$t_{\text{exit-stby}}$	–	–	200	μs	¹⁾	P_3.2.0.12
High-battery voltage threshold margin to the typ. V_{SETmax}	V_{HIGHMAR}	0.4	–	–	V	¹⁾ ; margin to the maximum set voltage VSET of 16.0 V	P_3.2.0.14

1) Not subject to production test.

3.3 Thermal resistance

This thermal data was generated in accordance with JEDEC JESD51 standards.

For more information, go to www.jedec.org.

Table 5 Thermal resistance

Parameter	Symbol	Values			Unit	Note or Test Condition	Number
		Min.	Typ.	Max.			
Junction to case	R_{thJC}	–	–	1.9	K/W	¹⁾ ; $T_A = 125^{\circ}\text{C}$; $P_V = 7\text{ W}$; only for packaged device	P_3.3.0.1

1) Not subject to production test.

3.4 Reduced operating range

If the voltage drops into the reduced operation range, all functions except the LIN communication of the TLE8881-2 are ensured, but parameters may be out of limit.

The LIN communication voltage range is defined in [Table 54](#).

If coming from stand-by mode, a voltage above the reduced operation range must be reached to ensure that internal voltage is activated and the TLE8881-2 will safely wake up from stand-by mode.

Main control block

4 Main control block

4.1 State diagram

The functional behavior of the TLE8881-2 is described in the state diagram in **Figure 3**.

The number in front of the state-change condition represents its priority in case multiple conditions are valid simultaneously (the lower number has higher priority).

TLE8881-2 allows the following operating states:

- Stand-by
- ComActive
- Pre-excitation
- Normal operation
- Default operation
- Excitation-off
- Overtemperature

Please refer to **Figure 3** and the following chapters for state transitions and detailed state descriptions. The related rotation parameters and the respective rotational speed events are shown in **Table 6** and **Table 7**.

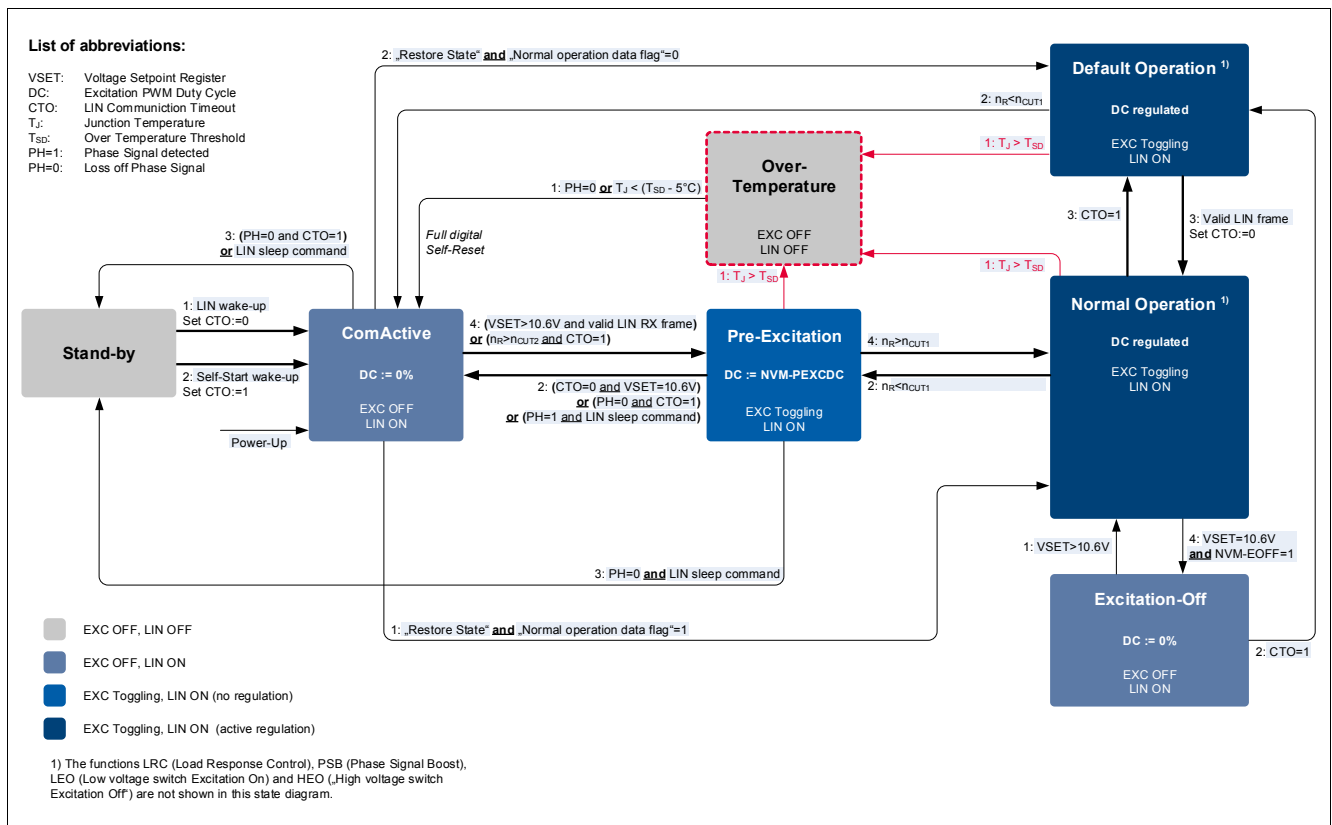

Figure 3 State diagram

Main control block

4.2 Rotational speed events

The rotational speed n_R is determined by measuring the frequency of the phase input. The phase frequency depends on the rotor speed as well as on the alternator pole pairs. The alternator pole pairs are configurable via **NVM-PP**. The self-start speed can be configured in the NVM field **NVM-SSS**.

The parameters as shown in **Table 6** influence the rotational speed events.

Table 6 Parameter rotor speed measurement

All parameters are valid for: $-40^{\circ}\text{C} < T_J < 150^{\circ}\text{C}$; $V_{BA}=14.5\text{ V}$ unless otherwise specified:

Parameter	Symbol	Values			Unit	Note or Test Condition	Number
		Min.	Typ.	Max.			
Cut-in rotor speed 1 (cranking speed threshold)	n_{CUT1}	500	560	610	rpm	¹⁾	P_5.2.0.1
Cut-in rotor speed 2 (self start detection threshold)	n_{CUT2}	Typ. value - 10%	Typ. value	Typ. value +10%	rpm	¹⁾ ; typ. value adjustable via NVM-SSS	P_5.2.0.2
LRC disable rotor speed	n_{LRCDIS}	Typ. value - 10%	Typ. value	Typ. value +10%	rpm	¹⁾ ; typ. value adjustable via RLRCDIS register (Chapter 6.4.3), or via NVM-LRCDIS	P_5.2.0.3

1) Not subject to production test.

The rotational speed n_R influences several state-transition events. Such events are detected according to the conditions in **Table 7**.

Table 7 Rotational speed events and conditions

Event	Description	Set condition (event is generated)	Clear condition (event is cleared)
“nCUT1” event	Necessary event for normal operation; If the event is detected, TLE8881-2 changes from pre-excitation to the normal operation state)	8 consecutive measurements with $n_R > n_{\text{CUT1}}$	3 consecutive measurements with $n_R < n_{\text{CUT1}}$
“nCUT2” event	Related to self-start speed (emergency start-up); If the event is detected, TLE8881-2 changes from stand-by to the pre-excitation state without waiting for the command of $V_{\text{SET}} > 10.6\text{ V}$	5 consecutive measurements with $n_R > n_{\text{CUT2}}$	1 measurement with $n_R < n_{\text{CUT2}}$ ¹⁾
“LRC disable” event	Used by the LRC function, refer to Chapter 5.11	5 consecutive measurements with $n_R > n_{\text{LRCDIS}}$	3 consecutive measurements with $n_R < n_{\text{LRCDIS}}$

1) No state transition associated.

Main control block

4.3 LIN communication events

The “CTO” event in the state diagram indicates the state of the LIN communication time-out flag:

- CTO = 1: The LIN communication timer expired, no valid LIN frame received within t_{CTO} time frame, or wake-up via phase signal detected
- CTO = 0: Valid LIN frame received or transmitted - LIN communication OK

Valid LIN frames contain LIN IDs such as 0x3C and 0x3D as well as the related IDs for a LIN RX/TX1/TX2/TX3 frame.

Table 8 Parameters for internal LIN timers

All parameters are valid for: $-40^{\circ}\text{C} < T_J < 150^{\circ}\text{C}$; $V_{BA} = 14.5\text{ V}$ unless otherwise specified:

Parameter	Symbol	Values			Unit	Note or Test Condition	Number
		Min.	Typ.	Max.			
LIN Communication time-out	t_{CTO}	2.7	3	3.3	s	¹⁾ ; If time is expired, then CTO := 1, else CTO := 0	P_5.3.0.1

1) Not subject to production test.

4.4 State description

TLE8881-2 includes the following functions which are available in each state according to **Table 9**:

- Current Limitation (CLIM), refer to **Chapter 5.4**
- Low Excitation On (LEO), refer to **Chapter 5.9**
- High-Voltage Excitation Off (HEO), refer to **Chapter 5.9**
- Phase Signal Boost (PSB), refer to **Chapter 5.11**
- Load Response Control (LRC), refer to **Chapter 5.12**
- Frequency-dependent Excitation Current Limitation (FEXLIM), refer to **Chapter 5.13**
- Regulation Parameters Control via LIN (F-Para), refer to **Chapter 5.14**
- Speed-dependent KiKp parameter sets (KiKp function), refer to **Chapter 5.15**
- Voltage-dependent KiKp function (VoKiKp), refer to **Chapter 5.16**
- Speed-dependent lowering of the HEO limit (LowHEO), refer to **Chapter 5.17**

4.4.1 Feature priorities

The availability of these mentioned features in the states of the state machine is shown in **Table 9**. Occasionally, some features can be enabled/disabled or adjusted via NVM fields. In addition to the information in **Table 9**, some features can be tuned using NVM fields.

Table 9 also includes a column to represent the related priority, if more than the features' conditions are fulfilled at the same time. Lower priority numbers have higher priorities.

As an example: While the TLE8881-2 state machine is in normal operation mode and the conditions are fulfilled for high-voltage excitation off ($V_{BA} > 16.5\text{ V}$) and phase signal boost ($V_{PH} < 7\text{ V}$), only the high-voltage excitation off will be activated. This means that the excitation driver stage will be switched off completely (DC := 0%).

Main control block

Table 9 Available features in state machine

Feature	Priority	States of state machine					
		Com active	Pre-excitation	Normal operation	Default operation	Excitation-off	Overtemperature
HEO / LowHEO	1	–	✓	✓	✓	–	–
PSB	2	–	–	✓	✓	–	–
LEO	3	–	–	✓	✓	–	–
CLIM	4 ¹⁾	–	–	✓	–	–	–
FEXLIM	5	–	–	✓	✓	–	–
LRC	5 ¹⁾²⁾	–	–	✓	✓	–	–

- 1) LRC and CLIM have the same priority. Excitation PWM duty cycle is limited by the lower limiting value.
- 2) If LRC and CLIM/FEXLIM are active at the same time, the excitation PWM duty cycle is limited by the lower limiting value.

Note: Load Response Control (LRC) may control the rising gradient of the excitation PWM duty cycle and can be overridden by the immediate switch-on of the excitation output stage if the conditions for LEO are fulfilled ($V_{BA} < NVM-LEO$ voltage).

4.4.2 “Stand-by”

The TLE8881-2 is generally in stand-by mode when the engine of the vehicle is off. No voltage is induced into the stator because the rotor is standing still. The LIN communication is off. To avoid draining the battery, the stand-by mode current is defined to be very low. The only active circuits are “LIN wake-up” and “self-start detection”.

There are three ways to wake-up and to transfer from state “stand-by” to state “ComActive”:

- On the communication line of the LIN interface, pulses are detected which are longer than the specified bus dominant time for LIN wake-up, t_{LINWK} (refer to [Table 54](#)).
- The amplitude of the AC signal at the phase input surpasses the self-start wake-up threshold.
- Power-up at supply (from un-powered state).

The TLE8881-2 will return to stand-by from the ComActive state if no valid communication is received for a certain period of time (CTO = 1) and if the signal at the phase input is below the self-start wake-up threshold, or a LIN sleep command has been received.

For detailed definitions of all registers refer to [Chapter 6.4](#).

Table 10 State “stand-by” entry conditions

Entry from state	State entry condition
ComActive	(PH = 0 (loss of phase signal) AND CTO = 1 (no valid LIN frame received for t_{CTO})) OR LIN sleep command
Pre-excitation	PH = 0 (loss of phase signal) AND LIN sleep command

Table 11 State “stand-by” exit conditions

Exit to state	State exit condition
ComActive	LIN activity (set CTO := 0)

Main control block

Table 11 State “stand-by” exit conditions (cont’d)

Exit to state	State exit condition
ComActive	Self-start wake-up (set CTO := 1)
ComActive	Power-up

Table 12 State “stand-by” behaviors

Function	Behavior mode
Excitation PWM duty cycle	0%
LIN bus communication	Only wake-up detection
Restore state function	Disabled

4.4.3 State “ComActive”

While in ComActive state, the device is ready for communication, but the rotor coil of the alternator is not yet energized through the excitation output stage.

Table 13 State “ComActive” entry conditions

Entry from state	State entry condition
-	Power-up
Every state	Logic reset
Stand-by	LIN activity (set CTO = 0)
Stand-by	Self-start wake-up (set CTO = 1)
Default operation	$n_R < n_{CUT1}$
Overtemperature	PH = 0 (loss of phase signal) OR no overtemperature detected ($T_J < (T_{SD} - 5^\circ\text{C})$)
Pre-excitation	(CTO = 1 (no valid LIN frame received for t_{CTO}) AND PH = 0 (loss of phase signal)) OR (VSET = 10.6 V AND CTO = 1 (valid LIN frame received)) OR (LIN sleep command AND PH = 1 (phase signal detected))

Table 14 State “ComActive” exit conditions

Exit to state	State exit condition
Normal operation ¹⁾	Restore state information is valid AND “normal operation data bit flag” = 1 (Chapter 8.5)
Stand-by	(PH = 0 (loss of phase signal) AND (CTO = 1 (no valid LIN frame received for t_{CTO}))) OR LIN sleep command)
Pre-excitation	(Valid LIN RX frame received AND VSET > 10.6 V) OR ($n_R > n_{CUT2}$ AND CTO = 1 (no valid LIN frame received for t_{CTO}))
Default operation ¹⁾	Restore state information is valid AND “normal operation data bit flag” = 0

1) In case of an inadvertent logic reset

Main control block

Table 15 State “ComActive” behaviors

Function	Behavior mode
Excitation PWM duty cycle	0%
LIN bus communication	Fully functional
Restore state function	Inactive (register data not updated)

4.4.4 State “pre-excitation”

Pre-excitation state is the entering state for normal and/or default operation state. The pre-excitation state is designed to energize the rotor coil of the alternator during the engine cranking phase. In this state, the alternator should generate almost no power to the output, but enough energy to have a proper phase signal. The pre-excitation state provides a fixed excitation PWM duty cycle at the excitation output stage which can be adjusted via [NVM-PEXCDC](#).

Table 16 State “pre-excitation” entry conditions

Entry from state	State entry condition
ComActive	(Valid LIN RX frame received AND VSET > 10.6 V) OR $(n_R > n_{CUT2}$ AND CTO = 1 (no valid LIN frame received for t_{CTO}))
Normal operation	$n_R < n_{CUT1}$

Table 17 State “pre-excitation” exit conditions

Exit to state	State exit condition
ComActive	Logic reset
Overtemperature	Overtemperature detected ($T_J > T_{SD}$)
Normal operation	$n_R \geq n_{CUT1}$
ComActive	(CTO = 1 (no valid LIN frame received for t_{CTO}) AND PH = 0 (loss of phase signal)) OR (VSET = 10.6 V AND CTO = 0 (valid LIN frame received)) OR (LIN sleep command AND PH = 1 (phase signal detected))
IC in stand-by	PH = 0 (loss of phase signal) AND (LIN sleep command)

Table 18 State “pre-excitation” behaviors

Function	Behavior mode
Excitation PWM duty cycle	Fixed - adjustable in EEPROM
LIN bus communication	Fully functional
Restore state function	Inactive (register data not updated)

4.4.5 State “normal operation”

The normal operation state is used to deliver power to the board net with control of the ECU. The entry and exit conditions are shown in the following tables.

Main control block

Table 19 “Normal operation” entry conditions

Entry from state	State entry condition
ComActive	Restore state information is valid AND “normal operation data bit flag” = 1 (Chapter 8.5)
Pre-excitation	$n_R \geq n_{CUT1}$
Default operation	Valid LIN frame received (CTO := 0)
Excitation off	VSET > 10.6 V, if NVM-EOFF = 1 _B

Table 20 State “normal operation” exit conditions

Exit to state	State exit condition
ComActive	Logic reset
Overtemperature	Overtemperature detected ($T_J > T_{SD}$)
Pre-excitation	$n_R < n_{CUT1}$
Default operation	CTO = 1 (no valid LIN frame received for t_{CTO})
Excitation off	VSET = 10.6 V, if NVM-EOFF = 1 _B

Table 21 State “normal operation” behaviors

Function	Behavior mode
Excitation PWM duty cycle	According to control characteristics (Table 36)
LIN bus communication	Fully functional
Restore state function	Active AND “normal operation data bit flag” = 1; (some register data is updated)

4.4.6 State “excitation off”

The excitation-off state is used to quickly switch off the EXC output, setting the internal register VSET to 10.6 V via the LIN communication. This state is only available, if **NVM-EOFF** = 1_B.

Table 22 State “excitation off” entry conditions

Entry from state	State entry condition
Normal operation	VSET = 10.6 V, when NVM-EOFF = 1

Table 23 State “excitation off” exit conditions

Exit to state	State exit condition
ComActive	Logic reset
Normal operation	VSET > 10.6 V, if NVM-EOFF = 1 _B
Default operation	CTO = 1 (no valid LIN frame received for t_{CTO})

Main control block

Table 24 State “excitation off” behaviors

Function	Behavior mode
Excitation PWM duty cycle	0%
LIN bus communication	Fully functional
Restore state function	Inactive (register data not updated)

4.4.7 State “default operation“

The default operation state is defined for the case that no LIN communication and rotating alternator are available.

The state machine will enter the default operation state if the LIN communication is not functional for more than t_{CTO} . For this reason, while entering this state TLE8881-2 will reset the internal LIN RX registers to their default configuration.

The TLE8881-2 will apply the default register values upon entry (see [Chapter 6.5](#)). As soon as a valid LIN frame is received, the TLE8881-2 will leave default operation and enter the normal operation state.

Table 25 State “default operation” entry conditions

Entry from state	State entry condition
Normal operation	CTO = 1 (no valid LIN frame received for t_{CTO})
Excitation off	CTO = 1 (no valid LIN frame received for t_{CTO})
ComActive	Restore state information is valid AND “normal operation data bit flag” = 0 (Chapter 8.5)

Table 26 State “default operation” exit conditions

Exit to state	State exit condition
ComActive	Logic reset
Overtemperature	Overtemperature detected ($T_J > T_{SD}$)
ComActive	$n_R < n_{CUT1}$
Normal operation	Valid LIN frame received

Table 27 State “default operation” behaviors

Function	Behavior mode
Excitation PWM duty cycle	According to control characteristics (Table 36)
LIN bus communication	Available, but communication is timed out (CTO = 1)
Restore state function	Active AND “normal operation data bit flag” = 0; (some register data is updated)

4.4.8 State “overtemperature”

If the TLE8881-2 detects an overtemperature, a critical condition is generally assumed and all outputs are switched off and the internal power consumption is reduced to a minimum. After returning from an overtemperature state (hysteresis avoids toggling around T_{SD} value), a self-reset is triggered and the default values are set.

Main control block

Table 28 State “overtemperature” entry conditions

Entry from state	State entry condition
Pre-excitation	Overtemperature detected ($T_J > T_{SD}$)
Normal operation	
Default operation	

Table 29 State “overtemperature” exit conditions

Exit to state	State exit condition
ComActive	Logic reset
ComActive ¹⁾	PH = 0 (loss of phase signal) OR no overtemperature detected ($T_J < (T_{SD} - 5^{\circ}\text{C})$)

1) Additional action: Logic reset, all internal registers will be initialized (see Table 5)

Table 30 State “overtemperature” behaviors

Function	Behavior mode
Excitation PWM duty cycle	0%
LIN bus communication	Not available
Restore state function	Inactive (register data not updated)

4.5 Diagnostic flags

The TLE8881-2 supplies a set of status-, abnormality- and LIN communication error flags readable via the LIN interface. These error flags generally have specific root causes.

The following diagnosis flags are available:

F-HT, F-ROT, F-EL, F-CTO, F-CEF

The LIN communication error flags are stated in [Table 31](#). The LIN communication error flags such as F-CTO and F-CEF are cleared by a logic reset or by a LIN read-out via TX1 or TX3.

Table 31 Diagnosis table for LIN communication error flags

Abnormality	Conditions	Action
LIN communication time-out detected	No valid LIN frame detection for more than t_{CTO}	F-CTO := 1
LIN 1.3 error detected	At least one of these errors is detected: <ul style="list-style-type: none"> Parity error Sync field error Checksum error Bit error Frame error 	F-CEF := 1
LIN 2.1 error detected	At least one of these errors is detected: <ul style="list-style-type: none"> Checksum error Bit error Frame error 	F-CEF := 1

Main control block

4.5.1 High-temperature diagnostic flag

The high-temperature diagnostic flag F-HT is set when the junction temperature of the chip reaches the T_{COMP} threshold. The F-HT flag is communicated without debouncing (refer to [Chapter 5.6](#) for detailed information).

Table 32 Error table: F-HT flag

Failure case	Conditions	States			
		ComActive	Pre-excitation	Normal operation	Excitation-off
No abnormality	Normal conditions	0	0	0	0
High temperature	$T_J > T_{COMP}$	-	-	1	-

Note: In some states the condition cannot be detected or it does not influence the value of the flag (indicated with “-”).

4.5.2 Mechanical error flag

The mechanical error flag F-ROT can be configured in EEPROM via [NVM-FROT_SEL](#), see [Table 33](#).

Table 33 Error table: F-ROT flag

Failure case	Conditions	NVM settings	States				
			ComActive	Pre-excitation	Normal operation	Excitation-off	
No abnormality ¹⁾	Normal conditions	NVM-FROT_SEL = 00 _B (VDA)	0	1	1	0	0
		NVM-FROT_SEL = 01 _B	1	1	1	0	1

1) F-ROT flag is a state indicator and can be configured by [NVM-FROT_SEL](#). A mechanical error is indicated by an unexpected state transition which can be detected with the F-ROT flag.

4.5.3 Electrical error flag

The electrical error flag F-EL is debounced as specified in [Table 35](#).

The electrical error flag F-EL is set if one of the conditions described in [Table 34](#) is detected for longer than the deglitch filter time $t_{F-EL,Set}$ (see [Table 35](#)).

If none of the condition is detected for longer than the deglitch filter time $t_{F-EL,Reset}$ (see [Table 35](#)), the flag returns to the initial value described by the “normal conditions” row.

All analogue protection functions (analogue HEO, over-current protection, over-temperature protection, watchdog monitoring) will trigger the conditions for “field voltage too low” or “loading error”. Thus, F-EL will be set according to these failure cases.

Main control block

Table 34 Error table: F-EL flag

Failure case	Conditions	NVM settings/ speed	States			
			ComActive	Pre-excitation	Normal operation	Excitation off
No abnormality	Normal conditions	–	0	0	0	0
Broken drive belt, phase circuit broken, EXC system broken, stalled alternator	Phase signal error; $V_{PH,max} < 7\text{ V}$ or $V_{PH,min} > 1\text{ V}$ for 1 PSB period (Chapter 5.11)	$n_R < n_{CUT1}$	–	–	–	–
		$n_R > n_{CUT1}$	–	–	1	–
EXC terminal short to B+, excitation output stage in short circuit	Continuous full field; $V_{EXC} > 1\text{ V}$ during low-time of EXC PWM ¹⁾	–	1	–	1	1
EXC terminal short to GND, free-wheeling diode in short circuit ²⁾	Field voltage too low; $V_{EXC} < 1\text{ V}$ during high-time of EXC PWM ³⁾	–	–	–	1	–
Excitation coil broken	Loading error; DC = 100% and <i>four measurements with</i> $I_{EXC} < I_{EXC,100}$ ⁴⁾	–	–	–	1	–
Double battery, battery charger, broken regulator EXC control	VBA too high; $V_{HIGH} < V_{BA}$ (Chapter 5.10) or $V_{LowHEO} < V_{BA}$ if LowHEO is active (Chapter 5.17)	NVM-HEO_ERR_EN = 0 _B	–	–	–	–
		NVM-HEO_ERR_EN = 1 _B	1	1	1	1
Overloading, broken rectifier system of alternator, broken stator system	VBA too low; $V_{LOW} > V_{BA}$ ⁵⁾ , (Chapter 5.9)	NVM-LEO_ERR_EN = 0 _B	–	–	–	–
		NVM-LEO_ERR_EN = 1 _B	1	–	1	1

- 1) No detection of short to B+ if DC > 85%
- 2) The same error reporting can be caused by internal error conditions like e.g. OT of excitation output stage or over current protection of excitation output stage.
- 3) No detection of short to GND if DC < 15%
- 4) Refer to [Chapter 5.3](#) for information on the sample update rates.
- 5) If the LEO function is activated. Refer to [Chapter 5.9](#) for more details.

Main control block

Note: In some states the condition cannot be detected or it does not influence the value of the flag (indicated with “-”).

The F-EL debounce filter is active according to the selection in **NVM-T_EL_ERR**. The filter time is specified in **Table 35**.

Table 35 Parameters for diagnostic flag delays

All parameters are valid for: $-40^{\circ}\text{C} < T_J < 150^{\circ}\text{C}$; $V_{BA} = 14.5\text{ V}$ unless otherwise specified:

Parameter	Symbol	Values			Unit	Note or Test Condition	Number
		Min.	Typ.	Max.			
Delay time to set diagnostic flag F-EL	$t_{F-EL,Set}$	150	250	350	ms	1); NVM-T_EL_ERR = 0 _B	P_5.5.3.1
Delay time to set diagnostic flag F-EL	$t_{F-EL,Set}$	900	1000	1100	ms	1); NVM-T_EL_ERR = 1 _B	P_5.5.3.3
Delay time to reset diagnostic flag F-EL	$t_{F-EL,Reset}$	20	62.5	100	ms	1);	P_5.5.3.2

1) Not subject to production test.

Regulation functions

5 Regulation functions

5.1 Control system

Table 36 Parameter control system

All parameters are valid for: $-40^{\circ}\text{C} < T_J < 150^{\circ}\text{C}$; $V_{\text{BA}} = 14.5\text{ V}$ unless otherwise specified:

Parameter	Symbol	Values			Unit	Note or Test Condition	Number
		Min.	Typ.	Max.			
Control accuracy of output voltage	V_{BA}	VSET - 0.2	–	VSET + 0.2	V	1) 2) 3) Closed loop operation; TSC function not limiting VSET;	P_6.2.0.1
Control accuracy at load variations	V_{BA}	-150	–	150	mV	1) 3); Relative to static value Test condition: $5\text{ A} < I_{\text{ALT}} < 0.9 * I_{\text{ALTMAX}}$; $n_{\text{ROT}} = 6000\text{ rpm}$	P_6.2.0.2
Control accuracy at speed variations	V_{BA}	-50	–	150	mV	1) 3); Relative to static value Test condition: $I_{\text{ALT}} = 5\text{ A}$, $T_J = +25^{\circ}\text{C}$ $2500 \leq n_{\text{ROT}} < 18000\text{ rpm}$	P_6.2.0.3
Excitation PWM frequency	f_{EXC}	–	220	–	Hz	In state “normal operation” and “default operation”. In state “pre-excitation”, if NVM- PREEXC_27HZ5_DIS = 1 _B See oscillator tolerance (Chapter 8.3)	P_6.2.0.4
Excitation PWM frequency	f_{EXC}	–	27	–	Hz	In state “pre-excitation”, if NVM- PREEXC_27HZ5_DIS = 0 _B See oscillator tolerance (Chapter 8.3)	P_6.2.0.5
Average excitation PWM duty cycle	DC	0%	–	99.8%	–	1) 4) 8 bits resolution (= 0.39%) ⁵⁾	P_6.2.0.6
Excitation PWM duty cycle accuracy in state normal operation	DC _{acc}	- 10	–	+ 10	%	1); $L_{\text{Load}} = 5\text{ mH}$; $R_{\text{Load}} = 10\ \Omega$; $T_J = 25^{\circ}\text{C}$;	P_6.2.0.8
Excitation PWM duty cycle in state pre-excitation	DC	Typ. value - 10%	Typ. value	Typ. value + 10%	–	6) Typ. value adjustable by NVM field NVM-PEXCDC	P_6.2.0.7

1) Not subject to production test.

Regulation functions

- 2) Test condition: $I_{ALT} = 5\text{ A}$, $n_R = 6000\text{ rpm}$, $V_{SET} = 14.3\text{ V}$
- 3) V_{BA} measured between BA terminal and GND terminal.
- 4) Maximum average PWM duty cycle of 99.8% may not be completely applied to the excitation output stage because the current measurement function requires a periodic switch-off at the excitation pin which results in a reduced average PWM duty cycle (refer to [Chapter 5.3](#)).
- 5) This value represents the internal accuracy of the digital circuit. Externally the duty-cycle accuracy is dependent on the applied load and may vary.
- 6) The excitation PWM duty cycle in pre-excitation state should be adjusted in a way that the alternator provides an appropriate phase signal.

5.2 Excitation output driver

The excitation output stage is protected with a dedicated overtemperature sensor and a dedicated overcurrent protection. The characteristics related to the excitation output stage are stated in [Table 37](#).

The excitation MOSFET is driven with a curve shaping technique in order to improve the EMC behavior. Depending on [NVM-CSHT](#), the curve shaping can be deactivated at temperatures above 135°C.

Table 37 Parameter “excitation output driver”

All parameters are valid for: $-40^\circ\text{C} < T_J < 150^\circ\text{C}$; $V_{BA} = 14.5\text{ V}$ unless otherwise specified:

Parameter	Symbol	Values			Unit	Note or Test Condition	Number
		Min.	Typ.	Max.			
On resistance on die level	$R_{DSON,DIE}$	–	53	65	mΩ	$I_{EXC} = 1\text{ A}$; $T_J = 25^\circ\text{C}$	P_6.3.0.1
On resistance on die level	$R_{DSON,DIE}$	–	95	110	mΩ	$I_{EXC} = 1\text{ A}$	P_6.3.0.2
On resistance in package	$R_{DSON,PCK}$	–	60	–	mΩ	$I_{EXC} = 1\text{ A}$; $T_J = 25^\circ\text{C}$	P_6.3.0.3
On resistance in package	$R_{DSON,PCK}$	–	95	110	mΩ	$I_{EXC} = 1\text{ A}$	P_6.3.0.4
Switch on slew rate	SL_{ON}	0.8	–	3	V/μs	Test condition: Resistive load only	P_6.3.0.5
Switch off slew rate	SL_{OFF}	0.8	–	3	V/μs	Test condition: Resistive load only ¹⁾	P_6.3.0.6
DMOS overcurrent protection threshold	I_{EXC}	–	–	typ. NVM-CLIM +1.5A	A	$T_J = -40^\circ\text{C}$ NVM field NVM-CLIM	P_6.3.0.7
DMOS overcurrent protection threshold	I_{EXC}	–	typ. NVM-CLIM	–	A	$T_J = 25^\circ\text{C}$ NVM field NVM-CLIM	P_6.3.0.8
DMOS overcurrent protection threshold	I_{EXC}	typ. NVM-CLIM - 1.0A	–	–	A	$T_J = 150^\circ\text{C}$ NVM field NVM-CLIM	P_6.3.0.9
Excitation free wheeling voltage	V_{EXC}	-2.0	-1.7	–	V	$I_{EXC} = 8\text{ A}$; $T_J = 25^\circ\text{C}$, measured between EXC terminal and GND terminal	P_6.3.0.11

1) Not subject to production test.

Regulation functions

5.3 Excitation current measurement

The excitation current flowing through the free-wheeling path is measured while the excitation DMOS is switched off by using a dedicated shunt resistor. The sampled excitation current is averaged over several excitation PWM duty cycle periods.

The excitation current measurement functionality forces a single measurement cycle of the excitation current at least every 32 PWM periods. This single measurement cycle results in a maximum ON-time of the excitation PWM duty cycle of 93% and a minimum OFF-time of the excitation PWM duty cycle of 7% for one single PWM period.

The TLE8881-2 attempts to achieve a good balance between the maximum average excitation PWM duty cycle and a good sample rate of the excitation current. For all target duty cycle values below 93%, a sampling of the excitation current will be performed in every excitation PWM cycle. Achieving higher duty cycle values is managed by decreasing the sampling rate of the excitation current measurement. In such cases, the measurement is executed at frequencies up to $f_{EXC}/32$.

If the excitation current limitation function ([Chapter 5.4](#)) as well as the LIN Filters ([Chapter 6.6](#)) are active, the excitation DMOS is forced off with a higher frequency (up to the nominal excitation PWM frequency f_{EXC}) to perform new measurements more often.

Table 38 Parameter excitation current measurement

All parameters are valid for: $-40^{\circ}\text{C} < T_J < 150^{\circ}\text{C}$; $V_{BA} = 14.5\text{ V}$, unless otherwise specified:

Parameter	Symbol	Values			Unit	Note or Test Condition	Number
		Min.	Typ.	Max.			
Excitation current update rate	f_{CUPD}	$f_{EXC}/32$	–	f_{EXC}	Hz	–	P_6.4.0.1
Accuracy of the excitation current measurement	I_{EXCACC}	–	250	–	mA	$I_{EXC} \leq 5\text{ A}$; resistive or inductive load for 0 A (no open EXC)	P_6.4.0.2
Accuracy of the excitation current measurement	I_{EXCACC}	–	5%	–	–	$5\text{ A} < I_{EXC} \leq 8\text{ A}$	P_6.4.0.3
Accuracy of the excitation current measurement	I_{EXCACC}	–	10%	–	–	$I_{EXC} > 8\text{ A}$	P_6.4.0.4
Maximum average excitation PWM duty cycle	$DC_{MAX,avg}$	–	–	99.8%	–	Current limitation disabled; current measurement performed at minimum frequency of $f_{EXC}/32$ (higher values possible)	P_6.4.0.5

Regulation functions

Table 38 Parameter excitation current measurement (cont'd)

All parameters are valid for: $-40^{\circ}\text{C} < T_J < 150^{\circ}\text{C}$; $V_{\text{BA}} = 14.5\text{ V}$, unless otherwise specified:

Parameter	Symbol	Values			Unit	Note or Test Condition	Number
		Min.	Typ.	Max.			
Maximum average excitation PWM duty cycle	$DC_{\text{MAX,avg}}$	–	–	99.125%	–	Active filter for excitation Current (RMC Filter), Chapter 6.6.3 ; current measurement performed at minimum frequency of $f_{\text{EXC}}/8$ (higher values possible)	P_6.4.0.6
Maximum average excitation PWM duty cycle	$DC_{\text{MAX,avg}}$	–	–	99.6%	–	Enabled excitation current limitation function (both CLIM or FEXLIM); current measurement performed at minimum frequency of $f_{\text{EXC}}/16$ (higher values possible)	P_6.4.0.7

5.4 Limitation of Excitation Current (CLIM)

The Excitation Current Limitation (short: *CLIM*) limits the average output current of the excitation output stage to an adjusted upper current threshold.

CLIM can be active only in the normal and default operation states. The current thresholds are set differently according to the operation states in which TLE8881-2 is functioning, both via NVM or LIN fields. When changing the state from normal or excitation off mode to default mode, the excitation current limit (CLIM) is ramped to the new setting with 0.375A/s.

In case multiple thresholds for the same function are active simultaneously, TLE8881-2 shall use the more restrictive one. Basically, the limitation value (parameter CLIM) can be configured via the LIN interface (TLE8881-2 register “RCLIM”). For the limitation values, refer to **Chapter 6.4.4**. Beside the LIN-controlled limitation value, the FEXLIM function can adjust a specific limitation value (refer to **Chapter 5.13**).

If the excitation current limitation is activated, the configured voltage setpoint (VSET) may not be achieved, since the voltage regulator might require a higher excitation current.

5.5 Temperature measurement

The junction temperature, T_J , is measured every 4.5 ms.

A change of the temperature value is limited by the rise/fall gradient, TF_{RF} , while in the normal and default operation states only. For other operation states, changes of the temperature values are immediately applied (no usage of rise/fall gradient, TF_{RF})

The temperature value, which is driven by TF_{RF} , is used for:

- F-HT diagnosis flag, or
- Temperature compensation of the voltage setpoint (VSET) in case of $T_J > T_{\text{HT}}$
- Frequency dependent excitation current limitation (FEXLIM)

The detection of overtemperature, T_{SD} , is always derived from the non-limited temperature value (no usage of rise/fall gradient, TF_{RF}).

Regulation functions

Table 39 Parameter temperature measurements

All parameters are valid for: $-40^{\circ}\text{C} < T_J < 150^{\circ}\text{C}$; $V_{\text{BA}} = 14.5\text{ V}$, unless otherwise specified:

Parameter	Symbol	Values			Unit	Note or Test Condition	Number
		Min.	Typ.	Max.			
Temperature rise/fall gradient	T_{RF}	–	28	–	K/s	Used in normal operation, default operation	P_6.6.0.1
Junction temperature measurement tolerance	ΔT_J	-10	–	+10	K	–	P_6.6.0.2
Junction temperature measurement tolerance	ΔT_J	-5	–	+5	K	Device in “ComActive” at 25°C ambient temperature ¹⁾	P_6.6.0.3

1) Only wafer test

5.6 Temperature Setpoint Compensation (TSC)

The temperature compensation gradually decreases the voltage setpoint (VSET) based on the measured junction temperature of the device. To compensate the produced energy at the excitation output stage, VSET is decreased at higher temperatures.

The behavior of the temperature compensation in normal operation can be adjusted via EEPROM and LIN frames. **Figure 4** shows the behavior including the influence factors of the two parameters T_{HT} and the high-temperature gradient HTG.

T_{HT} is the high-temperature threshold from where the temperature compensation would be activated if the voltage setpoint is set to 16 V. T_{HT} can be adjusted in EEPROM via NVM field **NVM-THT** and via HTADJ (modifiable via RHT register in LIN RX frame). The adjustment via EEPROM is an absolute threshold value, whereas the adjustment via LIN adds a relative offset (positive or negative) to the EEPROM adjustment of the absolute threshold value. **NVM-HTG** defines the gradient of the temperature compensation phase for the voltage setpoint of 16 V.

The temperature compensation is activated as soon as the actual VSET intersects with the gradient HTG - intersection point is called T_{COMP} . Calculation of T_{COMP} (as shown in **Figure 4**), is stated in **Equation (5.1)**

(5.1)

$$T_{\text{Comp}} = \text{“NVM-THT”} + \text{HTADJ} + \frac{\text{VSET} - 16\text{ V}}{\text{“NVM-HTG”}}$$

The lower the HTG gradient, the later the compensation will be activated. The higher the actual voltage setpoint, the earlier the compensation will be activated.

As soon as $T_J > T_{\text{COMP}}$, the high-temperature diagnostic flag (F-HT) is set to 1.

Regulation functions

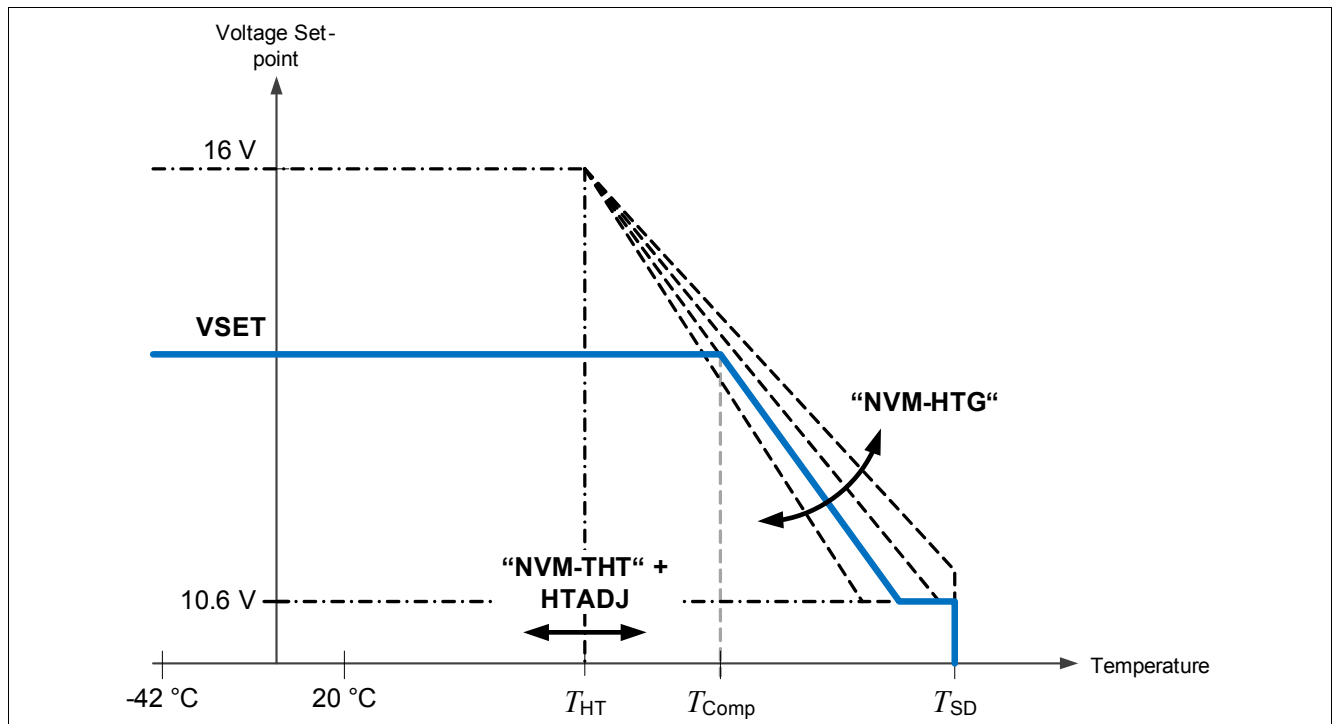

Figure 4 Temperature compensation example for specific values

5.7 Voltage measurement

The voltage measurement is performed at the VBA terminal with reference to the GND (ground) terminal.

TLE8881-2 has two different voltage measurement ranges:

- Measurement path with higher accuracy for the regulation range (10.6 V to 16 V).
- Measurement path with lower accuracy covering voltages outside the regulation range (8 V to 10.6 V and 16 V to 24 V).

The voltage measurement at the VBA terminal relative to the GND terminal is based on the accuracy as stated in [Table 40](#).

The overall voltage measurement is in the range between 8 V and 24 V.

Table 40 Parameter voltage measurement

All parameters are valid for: $-40^{\circ}\text{C} < T_J < 150^{\circ}\text{C}$; $V_{BA} = 14.5\text{ V}$ unless otherwise specified:

Parameter	Symbol	Values			Unit	Note or Test Condition	Number
		Min.	Typ.	Max.			
Accuracy of voltage measurement	V_{BATACC}	–	–	500	mV	$V_{\text{BA}} < 8.75\text{ V}$	P_6.8.0.1
Accuracy of voltage measurement	V_{BATACC}	–	–	400	mV	$8.75\text{ V} \leq V_{\text{BA}} < 9.5\text{ V}$	P_6.8.0.2
Accuracy of voltage measurement	V_{BATACC}	–	–	300	mV	$9.5\text{ V} \leq V_{\text{BA}} < 10.0\text{ V}$	P_6.8.0.3

Regulation functions

Table 40 Parameter voltage measurement (cont'd)

All parameters are valid for: $-40^{\circ}\text{C} < T_J < 150^{\circ}\text{C}$; $V_{BA} = 14.5\text{ V}$ unless otherwise specified:

Parameter	Symbol	Values			Unit	Note or Test Condition	Number
		Min.	Typ.	Max.			
Accuracy of voltage measurement	V_{BATACC}	–	–	250	mV	$10.0\text{ V} \leq V_{\text{BA}} < 10.5\text{ V}$	P_6.8.0.4
Accuracy of voltage measurement	V_{BATACC}	–	–	200	mV	$10.5\text{ V} \leq V_{\text{BA}} < 16.0\text{ V}$	P_6.8.0.5
Accuracy of voltage measurement	V_{BATACC}	–	–	400	mV	$16\text{ V} \leq V_{\text{BA}} \leq 16.5\text{ V}$	P_6.8.0.6
Accuracy of voltage measurement	V_{BATACC}	–	–	700	mV	$16.5\text{ V} < V_{\text{BA}} \leq 24\text{ V}$	P_6.8.0.7

5.8 Speed measurement

The measurable speed is limited in the range from 500 rpm to 25500 rpm. The determination of the speed is done by measuring the frequency of the signal at the phase terminal and normalizing to the alternator pole pairs (NVM field **NVM-PP**).

The speed measurement is only available in the normal operation state.

The representation of the speed measurement value is based on the accuracy as stated in **Table 41** and on the register resolution (capability of lowest significant bits).

Table 41 Parameter speed measurement

All parameters are valid for: $-40^{\circ}\text{C} < T_J < 150^{\circ}\text{C}$; $V_{BA} = 14.5\text{ V}$ unless otherwise specified:

Parameter	Symbol	Values			Unit	Note or Test Condition	Number
		Min.	Typ.	Max.			
Accuracy of speed measurement	W_{measACC}	–	10	–	%	1)	P_6.9.0.1

1) Not subject to production test.

5.9 Low Voltage Excitation On (LEO)

At a very low battery voltage, loading of the excitation coil is immediately induced by providing the maximum excitation current (excitation PWM duty cycle set to 100%) at the excitation output stage, until a defined threshold (V_{LOW}) is achieved. This feature is called Low-Voltage Excitation On (LEO).

The enabling of the LEO function in normal mode depends on the **NVM-LEOTIMERdis**.

If the **NVM-LEOTIMERdis** = 1_B , the LEO function is enabled immediately after the Normal Operation is entered.

If the LEO function gets activated, the excitation PWM duty cycle is set to 100%.

If the **NVM-LEOTIMERdis** = 0_B , a timer is started when V_{BA} exceeds V_{LOW} .

If V_{BA} falls below V_{LOW} while the timer is running, the timer is reset and starts to run as soon as V_{BA} exceeds V_{LOW} again.

Regulation functions

If V_{BA} stays above V_{LOW} during the runtime of the timer, the LEO function is enabled when the timer expires after t_{LEODEL} .

While LEO function is activated, the F-EL will be set with the respective debounce time, if NVM field **NVM-LEO_ERR_EN** set to 1_B .

While the LEO function is enabled, the regulation loop as well as any LRC ramp (Load Response Control specified in **Chapter 5.12**) continue their regular operation in the background.

The behavior after deactivating the LEO function ($V_{BA} > V_{LOW}$) can be selected via **NVM-LEOLRC**. The TLE8881-2 will set the LRC value to 100% DC, if **NVM-LEOLRC** = 0_B , or stays at the actual value if **NVM-LEOLRC** = 1_B .

LEO is not available for all states (refer to **Table 9**). For longer LEO periods the DC can be reduced for one PWM period in order to conduct a current measurement as mentioned in **Chapter 5.3**.

Table 42 Parameter low-voltage excitation on

All parameters are valid for: $-40^{\circ}\text{C} < T_J < 150^{\circ}\text{C}$; unless otherwise specified:

Parameter	Symbol	Values			Unit	Note or Test Condition	Number
		Min.	Typ.	Max.			
LEO threshold	V_{LOW}	8.25	8.75	9.15	V	¹⁾ ; NVM field NVM-LEO = 000_B ;	P_6.10.0.1
LEO threshold	V_{LOW}	8.6	9	9.4	V	¹⁾ ; NVM field NVM-LEO = 001_B	P_6.10.0.2
LEO threshold	V_{LOW}	8.85	9.25	9.65	V	¹⁾ ; NVM field NVM-LEO = 010_B	P_6.10.0.3
LEO threshold	V_{LOW}	9.2	9.5	9.8	V	¹⁾ ; NVM field NVM-LEO = 011_B	P_6.10.0.4
LEO threshold	V_{LOW}	9.45	9.75	10.05	V	¹⁾ ; NVM field NVM-LEO = 100_B	P_6.10.0.5
LEO threshold	V_{LOW}	9.75	10.0	10.25	V	¹⁾ ; NVM field NVM-LEO = 101_B	P_6.10.0.6
LEO threshold	V_{LOW}	10	10.25	10.5	V	¹⁾ ; NVM field NVM-LEO = 110_B	P_6.10.0.7

Regulation functions

Table 42 Parameter low-voltage excitation on (cont'd)

All parameters are valid for: $-40^{\circ}\text{C} < T_J < 150^{\circ}\text{C}$; unless otherwise specified:

Parameter	Symbol	Values			Unit	Note or Test Condition	Number
		Min.	Typ.	Max.			
LEO threshold	V_{LOW}	10.3	10.5	10.7	V	1); NVM field NVM-LEO = 111 _B	P_6.10.0.8
LEO enable timer ($V_{\text{BA}} > V_{\text{LOW}}$)	t_{LEODEL}	425	475	525	ms	1); If NVM-LEOTIMERdis = 0 _B ; Timer initiated after transition from Pre-Excitation to Normal Operation state	P_6.10.0.1 0

1) Not subject to production test, specified by design and functional test.

5.10 High Voltage Excitation Off (HEO)

At overshooting above a very high on-board power supply voltage level (V_{HIGH}), the excitation output stage is immediately disabled (lock to DMOS switch-off). As soon as the voltage level is below this threshold, the DMOS lock is released (DMOS can switch-on and switch-off as requested by regulation loop). This feature is called High-Voltage Excitation Off (HEO).

HEO is a safety feature to switch-off the excitation output stage at dangerous high voltage levels (e.g. caused by load dump in the on-board power supply). This feature has the highest priority above all other functions and is not available in all operation states (refer to [Table 9](#)).

The HEO threshold, V_{HIGH} , is stated in [Table 43](#).

The analogue HEO function can be activated/deactivated by **NVM-HEO_ANDis**. It is working independently parallel to the regular HEO function. It is not displayed with a LIN flag.

Table 43 Parameter High Voltage Excitation OFF

All parameters are valid for: $-40^{\circ}\text{C} < T_J < 150^{\circ}\text{C}$; $V_{\text{BA}}=14.5\text{ V}$ unless otherwise specified:

Parameter	Symbol	Values			Unit	Note or Test Condition	Number
		Min.	Typ.	Max.			
High-battery voltage threshold	V_{HIGH}	16.1	16.5	16.9	V	1)	P_6.11.0.1

Regulation functions

Table 43 Parameter High Voltage Excitation OFF (cont'd)

All parameters are valid for: $-40^{\circ}\text{C} < T_J < 150^{\circ}\text{C}$; $V_{BA}=14.5\text{ V}$ unless otherwise specified:

Parameter	Symbol	Values			Unit	Note or Test Condition	Number
		Min.	Typ.	Max.			
Analogue HEO activation voltage threshold	$V_{\text{HIGHan,en}}$	16.4	17.4	18.7	V	Operating in parallel to digitally implemented Over-Voltage Excitationoff if NVM-HEO_ANDis = 0 _B	P_6.11.0.2
Analogue HEO deactivation voltage threshold	$V_{\text{HIGHan,dis}}$	16.3	17.4	18.6	V	Operating in parallel to digitally implemented Over-Voltage Excitationoff if NVM-HEO_ANDis = 0 _B	P_5.11.0.1

1) Not subject to production test.

Regulation functions

5.11 Phase Signal Boost (PSB)

Phase Signal Boost (PSB) is an essential function to maintain a proper phase signal detection.

Conditions and behavior

The PSB is activated by default within the respective states (see [Table 9](#)). Deactivation will happen beyond those states. Enabling and disabling conditions as well as the behavior of the PSB function is described in the following.

The PSB function is activated if the upper peak voltage of V_{PH} is below the upper deactivation level or the lower peak voltage of V_{PH} is above the lower deactivation level.

The PSB function is deactivated if the upper peak voltage of V_{PH} is above the upper deactivation level and the lower peak voltage of V_{PH} is below the lower deactivation level.

If the PSB Function is activated the EXC output is set to 100% duty cycle for the PSB ON-time.

If the PSB Function is activated the EXC output is set to 0% duty cycle during the PSB OFF-time.

If the PSB function is active for longer than $t_{PSB,ON} + t_{PSB,OFF}$, a “PSB error” event (Trigger condition: PSB enabled for longer than 1 PSB period) is emitted and an F-EL event is triggered (see [Chapter 4.5](#)).

For the prioritization of different functions and their availability in different states see [Table 9](#).

Table 44 Parameter phase signal boost timer

All parameters are valid for: $-40^{\circ}\text{C} < T_J < 150^{\circ}\text{C}$; $V_{BA} = 14.5\text{ V}$ unless otherwise specified:

Parameter	Symbol	Values			Unit	Note or Test Condition	Number
		Min.	Typ.	Max.			
Minimum required phase voltage level for PSB activation	$V_{PSB,on,min}$	0.4	1	1.3	V	PSB is enabled as soon as phase voltage level (V_{PH}) goes below the specified voltage level	P_6.12.0.1
Maximum required phase voltage level for PSB activation	$V_{PSB,on,max}$	6.1	7	7.6	V	PSB is enabled as soon as phase voltage level (V_{PH}) overshoots the specified voltage level	P_6.12.0.2
ON time for PSB	$t_{PSB,ON}$	Typical value - 10%	Typ. value	Typical value + 10%	ms	¹⁾ ; Typ. value depends on NVM register NVM-T_PSB_ON_MAX	P_6.12.0.3
OFF time for PSB	$t_{PSB,OFF}$	253	282	311	ms	¹⁾	P_6.12.0.4

1) Not subject to production test.

5.12 Load Response Control (LRC)

Load Response Control (LRC) prevents engine speed hunting and vibration due to electrical loads which cause abrupt torque loading of the engine at lower speeds. This prevention is achieved by limiting the rise gradient of the excitation PWM duty cycle at the output stage.

Regulation functions

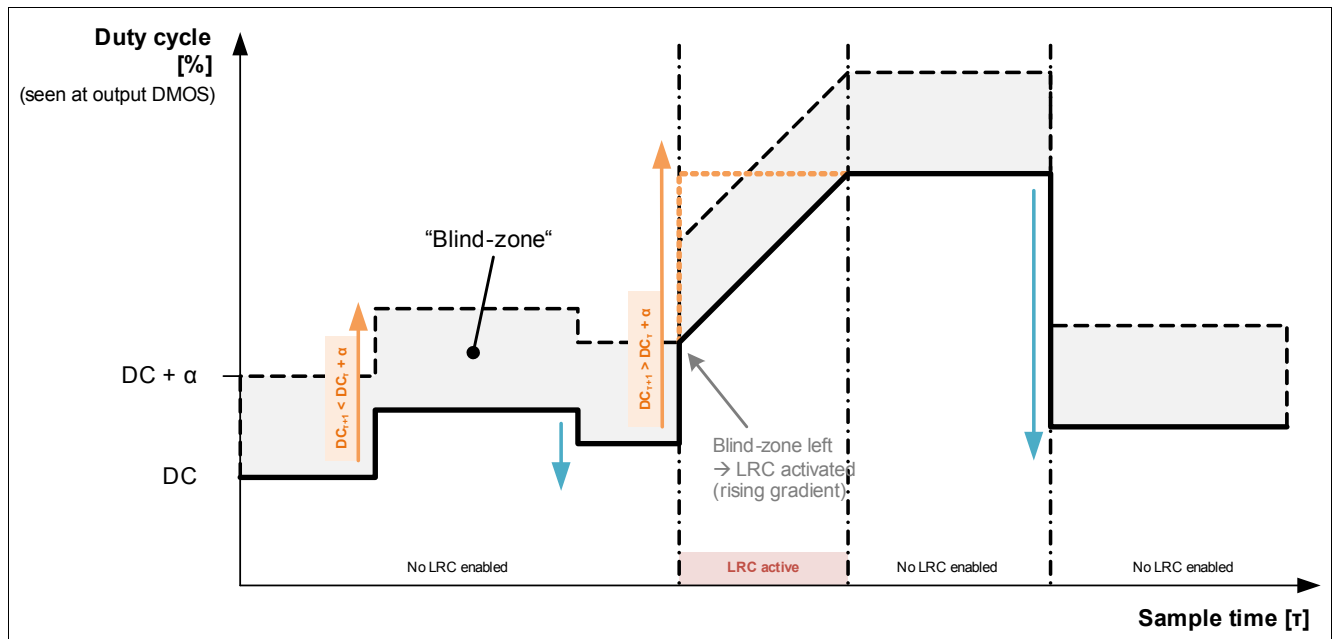

Figure 5 Principle of load response control

If the LRC function is disabled, the targeted Duty Cycle (DC) will be directly set to the regulator output value. If the LRC function is enabled and the targeted DC of the internal regulator is higher than the sum of current DC and LRC blind-zone value, the LRC function applies a rising gradient to the duty cycle of the excitation Output Stage.

The LRC blind-zone restrains the application of the LRC function for a defined range of DC changes. This prevents a continuous applied rise gradient of the DC especially for small DC changes and assures a better dynamic behavior.

If the LRC function is enabled and the targeted DC of the internal regulator is lower than the subtraction of current DC and LRC blind-zone value, the LRC function internally calculates a falling gradient which is not applied to the excitation Output Stage and therefore not seen at the excitation DMOS. This internally calculated falling gradient is used as the starting point for next re-application of a LRC rising gradient (e.g. the targeted DC is higher than the sum of the current DC and the LRC blind-zone value). This assures a better dynamic behavior.

Behavior of the LRC function after special conditions:

- If the state of the IC is restored to normal operation after an inadvertent reset, the LRC value is set to 100%.
- The behavior of the LRC function after an LEO event can be programmed by **NVM-LEOLRC**.
 Once LEO is deactivated, the LRC value is set to 100% if **NVM-LEOLRC** = 0_B or stays at the actual value if **NVM-LEOLRC** = 1_B

The principle of LRC and the LRC blind-zone is shown in **Figure 5**.

LRC rise-time (LRCRT)

The rising gradient is given by the LRC rise time (parameter LRCRT). This parameter can be configured via LIN RX frames (RB in Data Byte 2, refer to **Chapter 6.3.3**) and in NVM via **NVM-LRCRT** for default operation. The LRC rise-time is defined as the ramp-up time to go from 0% to 100% DC value, while the LRC function is activated ($n_R < n_{LRCDIS}$ and the positive DC change exceeds LRC blind-zone).

Regulation functions

LRC fall-time (LRCFT)

The falling gradient is given by the LRC fall time (parameter LRCFT). In contrast to LRCRT, this parameter can only be configured in NVM via **NVM-LRCFT**. It is defined as the ramp down time to go from 100% to 0% DC value, while the LRC function is activated ($n_R < n_{LRCDIS}$).

LRC blind-zone (LRCBZ)

The blind-zone is defined as the DC range, where the LRC function will not be activated. In case of a DC change which is higher than the blind-zone value (in percent of current DC), the LRC function will be activated for this DC change. This parameter can be configured via **NVM-LRCBZ** and **NVM-LRCBZ_0_SEL**.

Table 45 Parameter Load Response Control (LRC)

Parameter	Symbol	Values			Unit	Note or Test Condition	Number
		Min.	Typ.	Max.			
Blind zone	$BZ_{digital}$	3%	3%	4%	-	1); NVM-LRCBZ = 0 _B and NVM-LRCBZ_0_SEL = 0 _B	P_6.13.0.1
Blind zone	$BZ_{digital}$	6.25%	6.25%	8%	-	1); NVM-LRCBZ = 0 _B and NVM-LRCBZ_0_SEL = 1 _B	P_6.13.0.2
Blind zone	$BZ_{digital}$	12%	12%	14%	-	1); NVM-LRCBZ = 1 _B	P_6.13.0.3

1) Not subject to production test. BZ is digitally implemented, so that the typical value can be targeted by design. Tolerances are related to DC changes on the middle of the PWM on-time.

LRC disable speed (LRCDIS)

If the measured rotor speed is high, the applied engine torque can be strong enough to overcome speed-hunting and vibration due to a DC change. Therefore, the LRC disable speed can deactivate the LRC depending on the rotor speed, if $n_R > n_{LRCDIS}$.

This parameter can be configured via LIN RX frames (RC in Data Byte 2) and for the default mode in NVM via **NVM-LRCDIS**.

In summary, the LRC function is disabled in one or more of the following cases:

- $n_R > n_{LRCDIS}$ and TLE8881-2 register RLRCDIS is not 1111_B.
- TLE8881-2 register RLRCRT = 0000_B.

If the LRC is enabled by change of the registers LRCRT or LRCDIS, the limitation value starts on the actual excitation duty cycle value.

5.13 Frequency-dependent Excitation Current Limitation (FEXLIM)

Preventing higher torque loads especially for low temperature ranges as well as preventing heat-up due to high current flow is an important protection feature. The Frequency-dependent Excitation Current Limitation (FEXLIM) feature provides the possibility to adjust the limit of the excitation current depending on the measured rotation speed of the alternator pulley.

The FEXLIM feature limits the excitation current by adjusting the permanent current limitation (PCLIM) values. FEXLIM can operate in parallel to the excitation current limitation via LIN (**Chapter 5.4**), which limits the excitation current by adjusting the RCLIM values (RCLIM register).

Regulation functions

By using the NVM bit field **NVM-FEXLIM_EN** in the EEPROM, the FEXLIM function can be enabled/disabled, see **Table 47**.

FEXLIM feature is available for all device configurations (VDA-A, VDA-B, OEM2 and OEM1).

5.13.1 Parameters and limitation areas

The frequency dependent current limitation (FEXLIM) has 2 limitation areas separated by a speed-dependent threshold. This threshold is stated in **Table 48**.

Table 46 Excitation current limitation values within the different limitation areas

Limitation area	Conditions	PCLIM value
Area 1	$n_R < \text{SLM}$	PCLIM1
Area 4	$\text{SLM} < n_R$	PCLIM2

Figure 6 shows an overview of the limitation areas and the adjustment options.

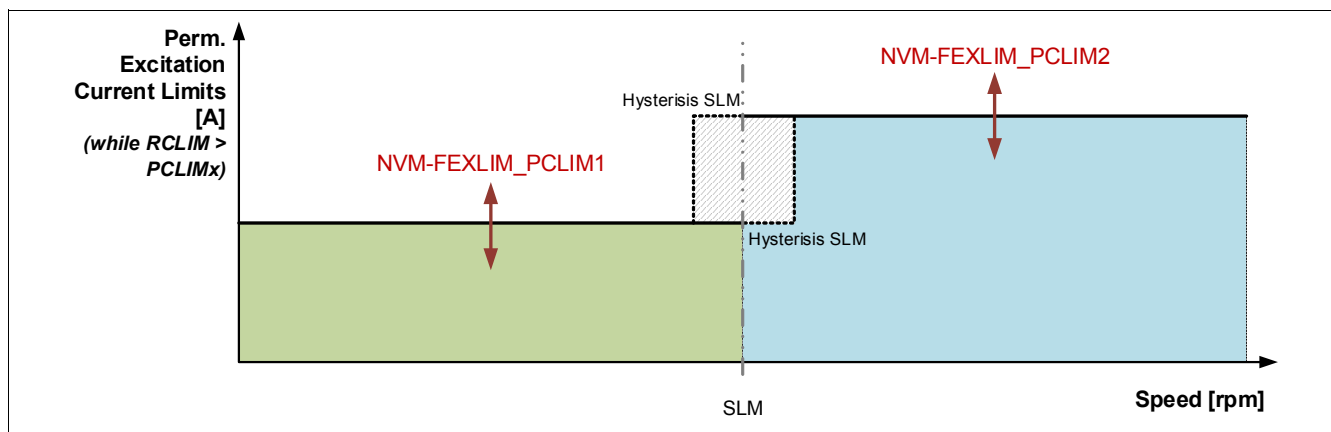

Figure 6 Principle of frequency-dependent current limitation overview of FEXLIM limitation areas and adjustment options (adjustments are red-highlighted, fixed values are black-contrasting)

5.13.2 Function activation/deactivation

A dedicated switch in the NVM is provided to activate/deactivate the FEXLIM function, **NVM-FEXLIM_EN**.

Table 47 Activation/deactivation switch for FEXLIM function

Activation/deactivation switch	Description	Behavior
NVM-FEXLIM_EN = 0 _B	Deactivate FEXLIM function	CLIM (Excitation Current Limitation) is defined by the RCLIM register value via LIN only.
NVM-FEXLIM_EN = 1 _B	Activate FEXLIM function	CLIM (Excitation Current Limitation) is defined by the RCLIM register value via LIN and by PCLIM via the FEXLIM feature.

5.13.3 FEXLIM vs. RCLIM register value

Beside the FEXLIM limitation values (as specified in **Table 46** and **Table 48**), LIN commands can limit the excitation current.

Regulation functions

The LIN RX frame rewrites the RCLIM register value. The RCLIM register is used for applying the CLIM (Excitation Current Limitation) within the normal operation state (refer to [Chapter 5.4](#)). While in parallel operation with FEXLIM, priorities have to be defined which actual limitation values will be used for CLIM.

Depending on the case, the following value for CLIM will be applied while RCLIM ($\neq 0$) is provided:

- If FEXLIM is enabled and $RCLIM < PCLIM$ (as defined in [Table 48](#)), then CLIM is applied by RCLIM.
- If FEXLIM is enabled and $RCLIM > PCLIM$, then CLIM is applied by PCLIM (as defined in [Table 48](#)).

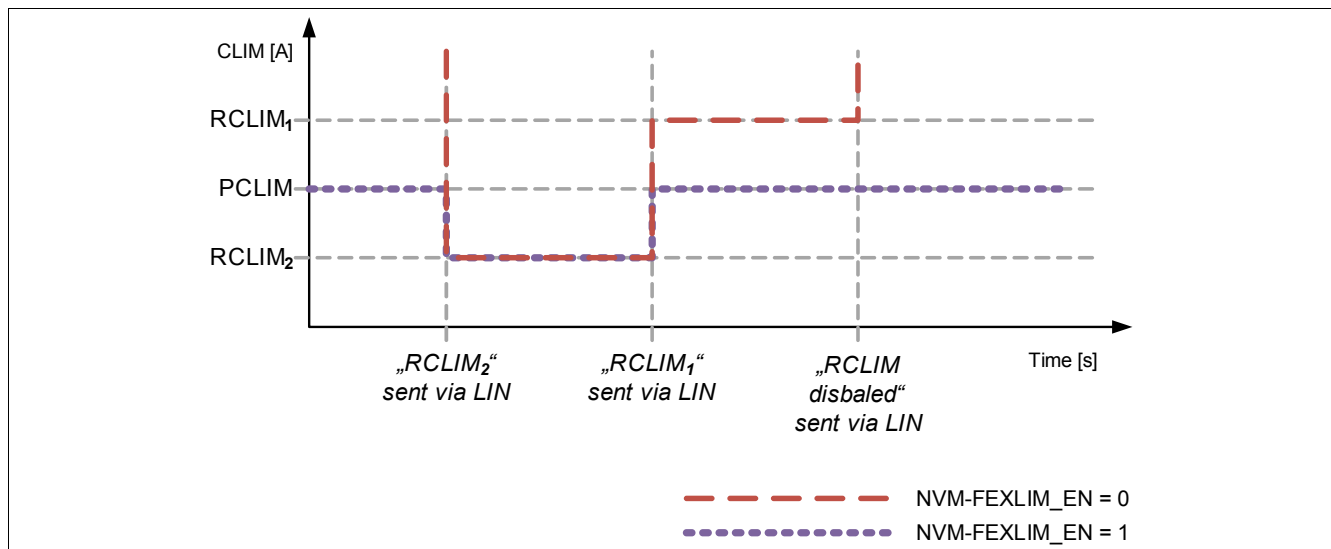

Figure 7 Priorities between FEXLIM and RCLIM

5.13.4 Transition behaviors

Smooth transition ramps between different PCLIM values or RCLIM values avoid hunting or vibration due to torque changes.

Any change of the PCLIM value over a speed threshold (e.g. PCLIM₁ to PCLIM₂ due to SLM threshold) will be handled by a smooth transition ramp, dt_{FSLOPE} (static value of 0.375 A/s, refer to [Table 48](#)).

Receiving of a RCLIM value which is different to the previous set RCLIM value can interrupt the transition ramp:

- Positive transition slopes (transition from a lower to a higher limitation value) are interrupted if a new RCLIM value is received. The new CLIM value to be adjusted for current limitation is defined by the static condition as described in [Chapter 5.13.3](#) (The CLIM value is defined by the RCLIM value, if $RCLIM < PCLIM$, or the CLIM value is defined by PCLIM, if $RCLIM > PCLIM$).
- Negative transition slopes (transition from a higher to a lower limitation value) are interrupted if a new RCLIM value is received which is lower than the transient PCLIM value (current value on the transition ramp). The new CLIM value is defined by the received RCLIM value.

Note: “New RCLIM” refers to a RCLIM value received via an RX LIN-Frame which is different to the RCLIM value received by an earlier RX LIN-Frame.

If the state machine transfers from the normal to the default operation state and $NVM-FEXLIM_EN = 0_B$ (FEXLIM function deactivated), a smooth transition ramp, dt_{FSLOPE} , from the last CLIM value to “no current limitation” (CLIM disabled) will be applied.

5.13.5 Function characteristics

[Table 48](#) provides all related characteristics of the FEXLIM function.

Regulation functions

Table 48 FEXLIM characteristics

All parameters are valid for: $-40^{\circ}\text{C} < T_J < 150^{\circ}\text{C}$; $V_{\text{BA}} = 14.5\text{ V}$, unless otherwise specified.
 All parameter are not subject to production tests.

Parameter	Symbol	Values			Unit	Note or Test Condition	Number
		Min.	Typ.	Max.			
Excitation current limitation for lower speed range	PCLIM1	-	NVM-FEXLIM_PCLIM1	-	A	-	P_6.14.5.3
Excitation current limitation for higher speed range	PCLIM2	-	NVM-FEXLIM_PCLIM2	-	A	-	P_6.14.5.4
Speed threshold SLM	SLM	-	3400	-	rpm	Dependent on hysteresis. Actual value is $\text{SLM} \pm \Delta\text{SLM}$	P_6.14.5.7
Hysteresis SLM	ΔSLM	-	150	-	rpm		P_6.14.5.10
Transition ramp	dt_{FSLOPE}	-	0.375	-	A/s	Slope between PCLIM1, PCLIM2. VDA-A / VDA-B / OEM1 / OEM2 variants.	P_6.14.5.12

5.13.6 Behavior with restore state function

In case of a restore state event (occurred due to micro-cut), the last PCLIM value can be restored. However, if micro-cuts occur during the drive of a transition slope, the targeted PCLIM value will be restored by the restore state function. An exemplary behavior is represented in **Figure 8**.

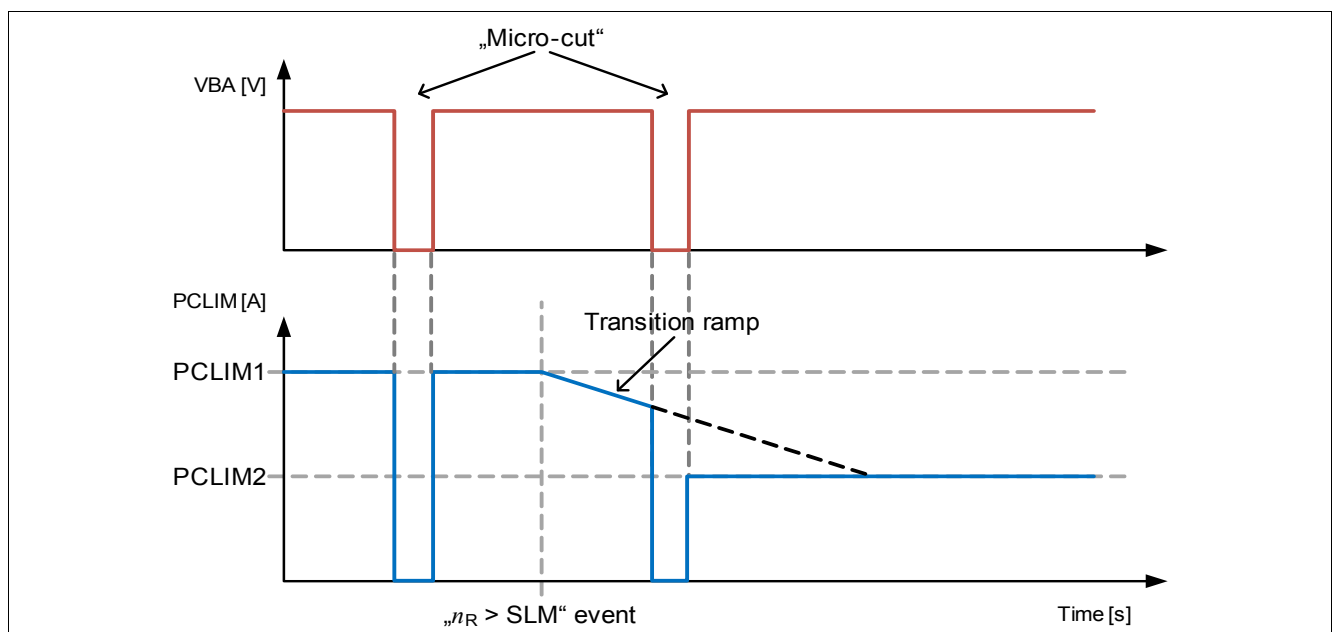

Figure 8 Example of the behavior of FEXLIM on restore state event

Regulation functions

5.14 Regulation parameters control via LIN (F-Para function)

The TLE8881-2 makes use of a full digital PI regulator to control the excitation output stage. Both the K_i and the K_p parameter are significant factors for the regulation dynamic.

Since the regulation dynamic may change depending on the application circumstances, the TLE8881-2 offers functionalities to change the set of regulation parameters.

The TLE8881-2 offers the F-Para functionality for switching from the normal K_iK_p setting to a previously selected regulation parameter set by setting a dedicated bit in the LIN RX frame. As long as that LIN bit is set, the PI regulator uses that pre-selected set of K_i and K_p factors. As soon as the LIN bit is reset, the default K_i and K_p factors are used again. The pre-selection is adjusted by the NVM field **NVM-RPARA_SEL**.

The pre-selection offers the possibility to either adjust a lower regulation dynamic or to not change the regulation dynamic.

The pre-selected regulation parameter can be activated by the ECU via LIN data field RH in the LIN RX frame (**Chapter 6.3.3**).

5.15 Speed-dependent K_iK_p parameter sets (K_iK_p function)

The TLE8881-2 allows to use different regulation K_iK_p parameter sets for the regulation of the EXC duty cycle dependent on the rotation speed n_R of the alternator.

The device provides 4 different K_iK_p parameter sets fixed which can be selected:

- “Normal” (default parameter)
- “slow”
- “slower”
- “slowest”

The name of the parameter sets is derived from the reaction speed of the regulation.

The behavior of the function is configured by the parameter **NVM-KiKp**. This is shown in **Table 49**.

Table 49 Configuration of K_iK_p function

Configuration switch	Description
NVM-KiKp= 00 _B	K_iK_p function disabled
NVM-KiKp = 01 _B	Simple K_iK_p function with K_iK_p set to “slowest”
NVM-KiKp = 10 _B	Simple K_iK_p function with K_iK_p set to “slower”
NVM-KiKp = 11 _B	3-stage K_iK_p function

The function can be operated as a simple K_iK_p function or a 3-stage K_iK_p described in **Figure 9** and **Figure 10**

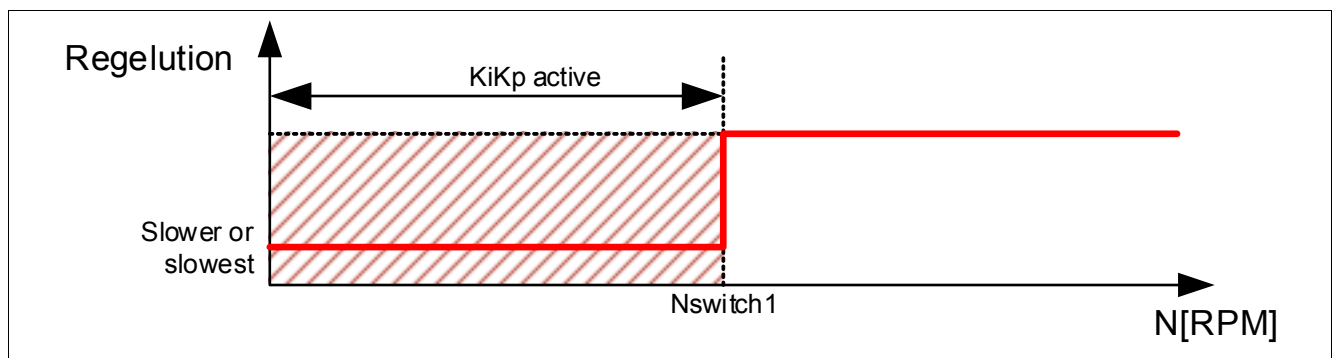

Figure 9 Simple K_iK_p function

Regulation functions

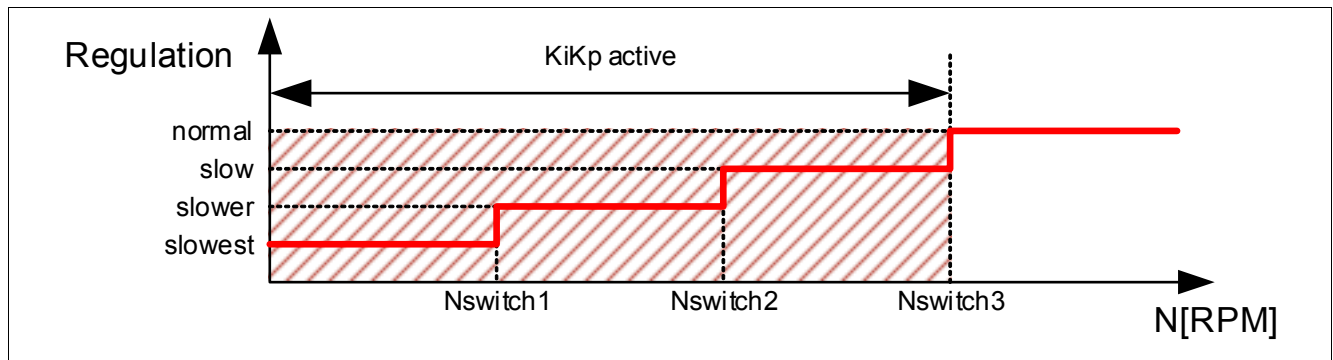

Figure 10 3-stage KiKp function

The selection of the different KiKp parameter sets is done based on the rotation speed n_R . The function allows up to 3 different speed thresholds $N_{switch1} \dots N_{switch3}$.

These thresholds can be selected by the parameter **NVM-Speed_TH**(see [Table 50](#)). The table shows the upper threshold and the lower threshold for the implemented hysteresis.

The change of the used KiKp parameter set is triggered by a KiKp Nswitch event. The criteria for this event are shown in [Table 51](#).

Table 50 Selection of Nswitch speed thresholds¹⁾

NVM-Speed_TH	Nswitch1 [rpm]	Nswitch2 [rpm]	Nswitch3 [rpm]
000 _B	2000 / 1800	2400 / 2200	2800 / 2600
001 _B	2200 / 2000	2600 / 2400	3000 / 2800
010 _B	2400 / 2200	2800 / 2600	3200 / 3000
011 _B	2600 / 2400	3000 / 2800	3400 / 3200
100 _B	2800 / 2600	3200 / 3000	3600 / 3400
101 _B	3000 / 2800	3400 / 3200	3800 / 3600
110 _B	3200 / 3000	3600 / 3400	4000 / 3800
111 _B	3400 / 3200	3800 / 3600	4200 / 4000

1) 2000 / 1800 rpm represent the upper and lower value of the hysteresis

Table 51 KiKp Nswitch events and conditions

Event	Description	Set condition (event is generated)	Clear condition (event is cleared)
“KiKp Nswitch” event	Event used to trigger the selection of the KiKp parameter sets	3 consecutive measurements with $n_R > N_{switch}$ (upper threshold of hysteresis)	3 consecutive measurements with $n_R < N_{switch}$ (lower threshold of hysteresis)

If the F-Para function is not active (set to 0 in the LIN-RX frame) and the KiKp function is activated in **NVM-KiKp**, the KiKp parameters requested by the KiKp function are applied.

Regulation functions

If the F-Para function is not active (set to 0 in the LIN-RX frame) and the KiKp function is not activated, the normal regulation parameters are applied.

If the F-Para function is active (set to 1 in the LIN-RX frame), the parameters requested by the F-Para function are applied.

5.16 Voltage-dependent KiKp function (VoKiKp function)

In order to avoid slow reaction of the IC on relatively high VBA voltages compared to V_{SET} , especially if slow KiKp parameter sets are chosen, the TLE8881-2 offers a voltage-dependent KiKp function (VoKiKp).

The function and its parameters can be selected by the NVM parameter **NVM-VoKiKp** shown in **Table 52**

Table 52 Configuration of VoKiKp function

NVM-VoKiKp	VoKiKp up threshold	VoKiKp down threshold
000 _B	VoKiKp disabled	
001 _B	0.35 V	0.25 V
010 _B	0.5 V	0.4 V
011 _B	0.65 V	0.55 V
100 _B	0.8 V	0.7 V
101 _B	+/- 0.5 V	+/- 0.4 V
110 _B	+/- 0.75 V	+/- 0.65 V
111 _B	+/- 1 V	+/- 0.9 V

If the VoKiKp function is active, it overrules the KiKp parameter set selection performed by the F-Para function or the KiKp function and forces the IC to use the KiKp parameter set “Normal”.

The activation and deactivation of the function is shown in **Figure 11**.

The function is activated if V_{BA} is higher than $V_{SET} + \text{VoKiKp up threshold}$ and deactivated if V_{BA} is lower than $V_{SET} + \text{VoKiKp down threshold}$. For the values 101_B, 110_B and 111_B the function is also activated if V_{BA} is lower than $V_{SET} - \text{VoKiKp up threshold}$ and deactivated if V_{BA} is higher than $V_{SET} - \text{VoKiKp down threshold}$.

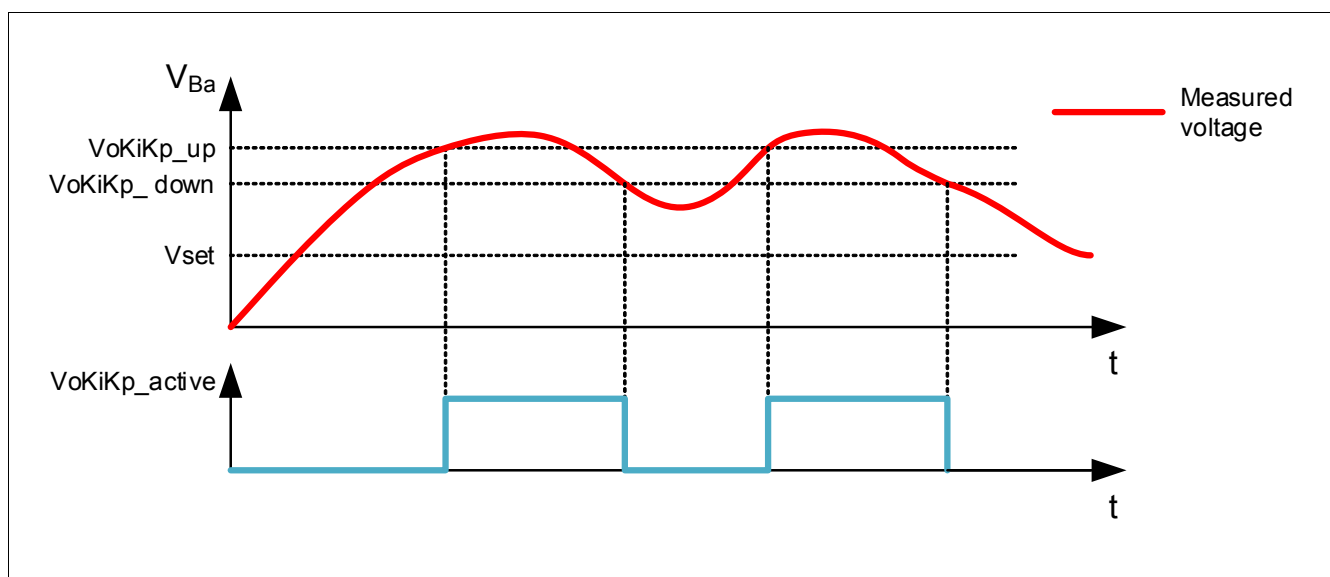

Figure 11 Voltage-dependent activation and deactivation of the VoKiKp function.

Regulation functions

The VoKiKp function is deactivated as well if the rotation speed is high. The deactivation threshold depends on the KiKp configuration (**Table 49**).

If the simple KiKp function is used or if the KiKp function is disabled, the VoKiKp function is deactivated if $n_R > N_{switch1}$.

If the three stage KiKp function is used the VoKiKp function is deactivated if $n_R > N_{switch3}$.

The speed dependence of the VoKiKp function can be activated/deactivated by the NVM parameter **NVM-VoKiKp_low_HEO_speed**.

Regulation functions

5.17 Speed-dependent lowering of the HEO limit (LowHEO function)

In order to optimize the reaction to high V_{BA} voltages in case of a low rotation speed, the TLE8881-2 offers a function to lower the HEO limit. This function is called LowHEO function.

The function and its parameters can be selected by the NVM parameter **NVM-LOW_HEO** shown in **Table 53**

Table 53 Configuration of the lowHEO function

NVM-LOW_HEO	LowHEO voltage V_{LowHEO}
00 _B	15.5 V
01 _B	15.65 V
10 _B	15.75 V
11 _B	LowHEO function disabled (default HEO 16.5 V used)

If the rotation speed n_R is lower than Nswitch1, the HEO limit is reduced to the preconfigured value set in the NVM parameter **NVM-LOW_HEO**.

In this situation, the V_{SET} voltage is limited to the lower HEO limit -500 mV.

The LowHEO function will trigger the F-EL diagnostic flag if $n_R < Nswitch1$ and the battery voltage is higher than the LowHEO voltage.

The speed dependence of the LowHEO function can be activated/deactivated by the NVM parameter **NVM-VoKiKp_low_HEO_speed**. If the speed dependence is disabled, **NVM-LOW_HEO** is applied for all rotation speeds.

For example, if the lower HEO limit is set to 15.5 V, the V_{SET} voltage is limited to 15 V.

This function is shown in **Figure 12**.

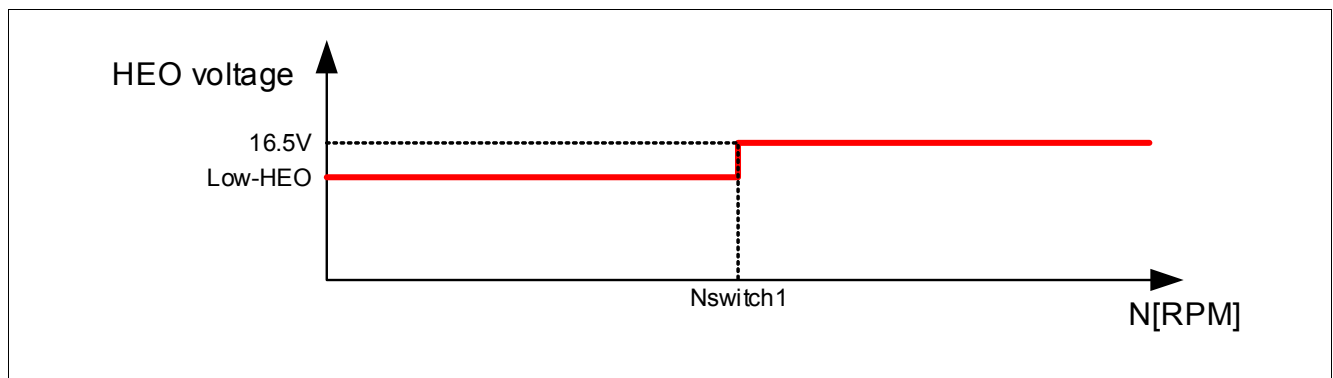

Figure 12 Speed-dependent lowering of the HEO limit

LIN interface

6 LIN interface

The protocol of the TLE8881-2 communication interface is implemented as LIN bus according to the LIN (Local Interconnect Network) specification. The physical layer is implemented according to the standard LIN 2.1 specification. The physical layer specification LIN 2.1 is a super set of previous LIN specifications, such as versions of LIN 2.0 or LIN 1.3.

The TLE8881-2 is qualified according to LIN 2.1 on the physical layer. Conformance test results are available on request.

The data link layer is implemented according to LIN 1.3 as well as LIN 2.1 specification (selectable via **NVM-LIN**).

The data exchange via the serial bi-directional LIN bus line follows the master-slave-principle, where the engine management ECU or the energy management ECU is arranged as master (LIN 1.3, or LIN 2.1) and the TLE8881-2 is designed as a slave node.

6.1 Bus topology

The LIN bus line is connected to the LIN terminal of the TLE8881-2 and to any driver/receiver of the bus connection. V_{SUP} is an internal voltage and supplies the pull-up resistor of the LIN bus line. This voltage is used for the definition of the voltage thresholds. A polarity protection diode between V_{SUP} and V_{BA} is described in the LIN standard and may be implemented in the LIN master. The TLE8881-2 uses an active polarity protection diode which is shorted in operational mode. Therefore, V_{SUP} is more or less equal to V_{BA} .

While in stand-by mode a wake-up circuitry detects signal pulses on the LIN bus line. If a pulse fulfills the wake-up pulse requirement, the TLE8881-2 will leave the stand-by mode and changes to ComActive state.

The LIN terminal of the TLE8881-2 is protected against short circuit to the GND terminal or VBA terminal. The LIN driver is protected against overload.

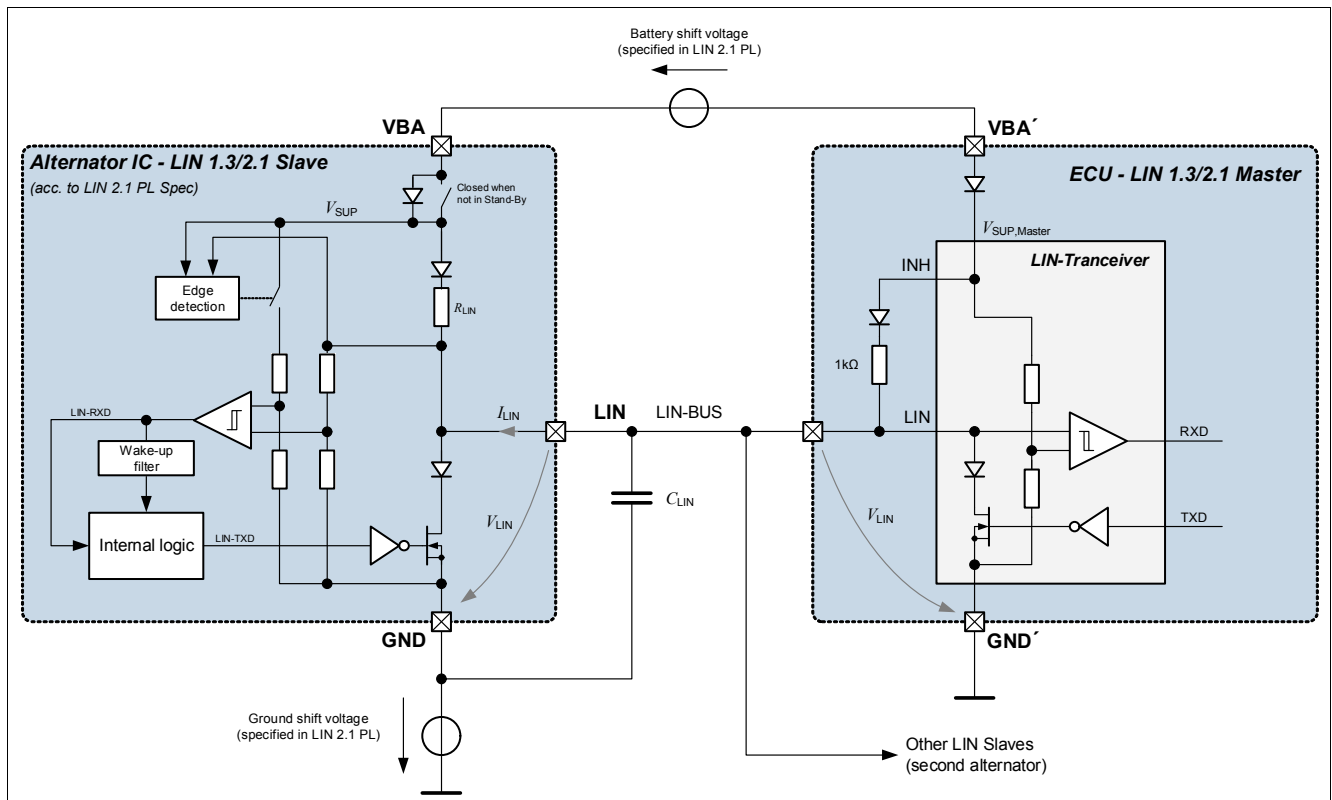

Figure 13 LIN bus configuration

LIN interface

6.2 Signal specification (physical layer)

The transferred data bits are encoded with the value ‘0’ (dominant level, bus line is clamped to GND) or ‘1’ (recessive, bus voltage is near to V_{BA}). For a correct transmission of a bit the bus voltage must be on the respective voltage level (dominant or recessive) at the bit sampling time of the receiver. Propagation delays as well as slew rates according the LIN specification have to be considered (refer to **Figure 14**).

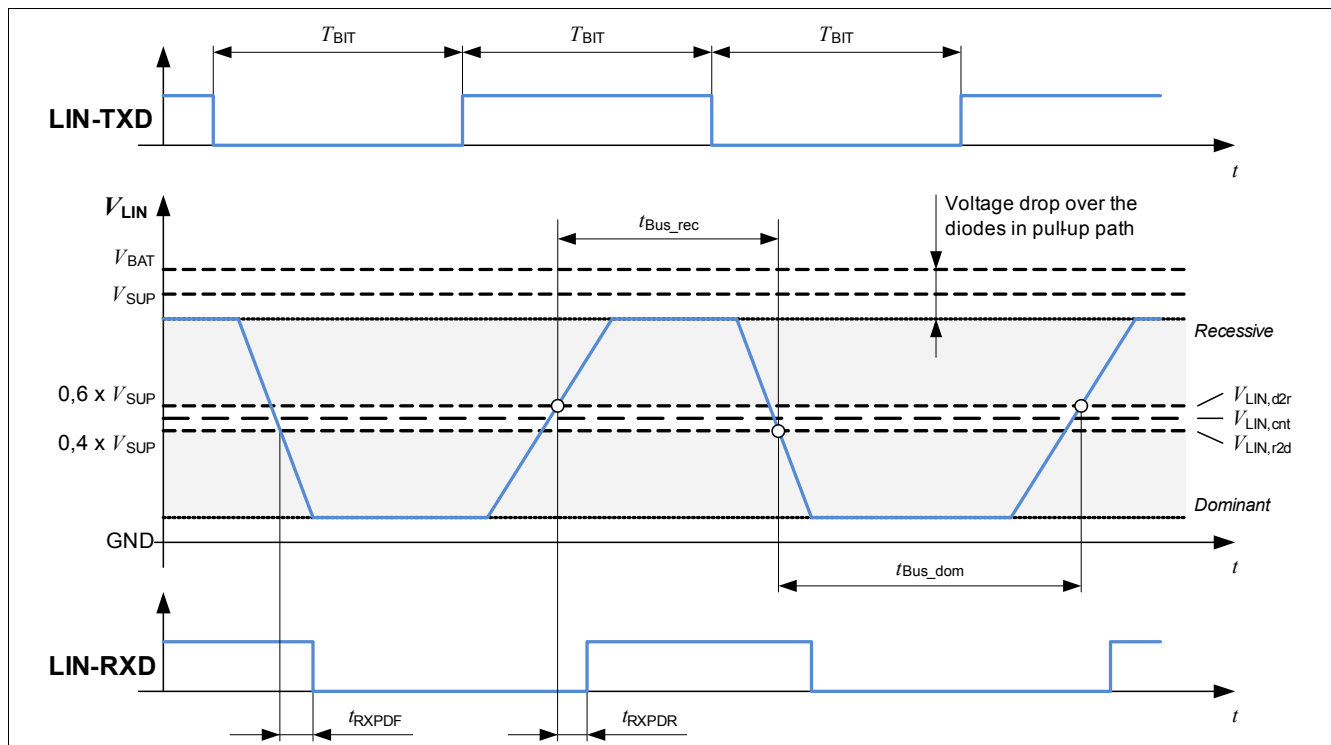

Figure 14 LIN signal specification

The LIN bus communication speed (within the specified limits) is automatically detected by the receiver using the Synch Byte of the header (for LIN 1.3 and for LIN 2.1). In addition to the associated start bit and stop bit, the Synch Byte is coded as 55_H (refer to **Figure 15**).

The falling curve of the bus voltage V_{LIN} (bit change from recessive to dominant) is mainly dependent on the driver implementation, while the rising curve of the bus voltage (bit change dominant to recessive) depends on the bus time constant $t_{LIN} = R_{LIN} \times C_{LIN}$. The bus time constant, t_{LIN} , has to be between 1 μ s and 5 μ s.

R_{LIN} is the overall network impedance and its value is depending on the number of bus nodes. Because the number of nodes should not exceed a maximum of 16, the minimum value is never below $R_{LIN} = 500 \Omega$. C_{LIN} is the overall network capacitance and must not exceed 10 nF.

C_{LIN} is the overall network capacity and consists of the master capacity, slave node capacities as well as bus wire length.

For more details concerning the bus line timing and characteristics, refer to the LIN 2.1 specification.

LIN interface

Table 54 Parameter LIN signal characteristics

All parameters are valid for: $-40^{\circ}\text{C} < T_J < 150^{\circ}\text{C}$; $V_{BA} = 14.5\text{ V}$, unless otherwise specified:

Parameter	Symbol	Values			Unit	Note or Test Condition	Number
		Min.	Typ.	Max.			
Receiver input voltage for proper communication	V_{LIN}	-3	–	40	V	Negative voltages could occur in case of ground shift between master and slave ¹⁾	P_7.2.0.1
Bit period	T_{BIT}	51	–	423	μs	For LIN master: communication speed between 2400 bit/s and 19200 bit/s (master clock tolerance $\pm 0.5\%$)	P_7.2.0.2
Bit period	T_{BIT}	50	–	432	μs	For TLE8881-2 slave node: maximum clock tolerance for communication between master and slave after synchronization is $\pm 2\%$	P_7.2.0.3
Interbyte delay in response	t_{BDEL}	–	0	–	μs	TLE8881-2 is sending the response immediately	P_7.2.0.4
Bus dominant time for the synch-break	t_{SYNBRK}	$13 \times T_{BIT}$	–	–	μs	T_{BIT} is the bit time ascertained in the synch-byte. Only whole-numbered (integer) multiples of T_{BIT} are applicable.	P_7.2.0.5
Bus idle time-out	$t_{LINIDLE}$	–	1300	–	ms	$t_{LINIDLE}$ ($25k \times T_{BIT}$ @ 19200 bit/s) only used for LIN 2.1 conformance test	P_7.2.0.6
Internal voltage for bus pull-up resistor supply	V_{SUP}	$V_{BA} - 1\text{ V}$	–	V_{BA}	V	¹⁾ ; maximum voltage drop (current dependent) on internal polarity protection diode is 1 V	P_7.2.0.7
Receiver voltage threshold for bit recessive to bit dominant detection	$V_{LIN,r2d}$	$0.4 \times V_{SUP}$	–	–	V	LIN 2.1 Param 17 (Figure 6.2)	P_7.2.0.8
Receiver voltage threshold for bit dominant to bit recessive detection	$V_{LIN,d2r}$	–	–	$0.6 \times V_{SUP}$	V	LIN 2.1 Param 18 (Figure 6.2)	P_7.2.0.9
Receiver center voltage	$V_{LIN,cnt}$	$0.475 \times V_{SUP}$	$0.5 \times V_{SUP}$	$0.525 \times V_{SUP}$	V	LIN 2.1 Param 19 (Figure 6.2)	P_7.2.0.10
Receiver hysteresis	$V_{LIN,hys}$	$0.07 \times V_{SUP}$	$0.1 \times V_{SUP}$	$0.175 \times V_{SUP}$	V	$V_{LIN,hys} = V_{LIN,d2r} - V_{LIN,r2d}$ LIN 2.1 Param 20	P_7.2.0.11
LIN wake-up threshold voltage	V_{LINWK}	$0.4 \times V_{SUP}$	–	$0.6 \times V_{SUP}$	V	–	P_7.2.0.12
Bus dominant time for LIN wake-up	t_{LINWK}	30	–	150	μs	–	P_7.2.0.13

LIN interface

Table 54 Parameter LIN signal characteristics (cont'd)

All parameters are valid for: $-40^{\circ}\text{C} < T_J < 150^{\circ}\text{C}$; $V_{BA} = 14.5\text{ V}$, unless otherwise specified:

Parameter	Symbol	Values			Unit	Note or Test Condition	Number
		Min.	Typ.	Max.			
Bus current limitation for dominant stat	I_{LINMAX}	40	–	200	mA	In full V_{BA} range; LIN 2.1 Param 12	P_7.2.0.14
Bus leakage current	$I_{LINLEAK}$	-1	–	–	mA	LIN-TXD = 1 (pull-down driver off), $V_{LIN} = 0\text{ V}$, $V_{BA} = 12\text{ V}$ LIN 2.1 Param 13	P_7.2.0.15
Bus leakage current (loss of ground)	$I_{LINLEAK}$	-1	–	1	mA	$V_{LIN} = -18\text{ V}$ to 0 V GND open on TLE8881-2; LIN 2.1 Param 15	P_7.2.0.16
Bus leakage current (loss of battery)	$I_{LINLEAK}$	–	–	20	μA	$V_{LIN} = 0\text{ V}$ to 18 V VBA open on TLE8881-2; LIN 2.1 Param 16	P_7.2.0.17
Bus leakage current (driver off)	$I_{LINLEAK}$	–	–	20	μA	$V_{LIN} = 8\text{ V}$ to 18 V $V_{BA} = 8\text{ V}$ to 18 V $V_{LIN} > V_{BA}$ LIN 2.1 Param 14	P_7.2.0.18
Voltage drop on serial diode in pull up resistor path	V_{LINDPU}	0.4	–	1	V	$V_{BA} = 6\text{ V}$ to 18 V , $V_{LIN} = 2\text{ V}$	P_7.2.0.19
Pull-up resistor for LIN slave node	$R_{LIN,Slave}$	20	30	60	k Ω	LIN 2.1 Param 26	P_7.2.0.20
Internal capacity for LIN slave node	$C_{LIN,Slave}$	10	–	80	pF	¹⁾ LIN 2.1 Param 37	P_7.2.0.21
LIN bus duty cycle D1 for 20 kbit/s	DC_{LIN}	0.396	–	–	–	^{1) 2) 3)} LIN 2.1 Param 27	P_7.2.0.22
LIN bus duty cycle D2 for 20 kbit/s	DC_{LIN}	–	–	0.581	–	^{1) 2) 4)} LIN 2.1 Param 28	P_7.2.0.23
LIN bus duty cycle D3 for 10.4 kbit/s	DC_{LIN}	0.417	–	–	–	^{1) 2) 5)} LIN 2.1 Param 29	P_7.2.0.24
LIN bus duty cycle D4 for 10.4 kbit/s	DC_{LIN}	–	–	0.590	–	^{1) 2) 6)} LIN 2.1 Param 30	P_7.2.0.25
Rising receiver propagation delay	t_{RXPDR}	–	–	6	μs	⁷⁾ LIN 2.1 Param 31	P_7.2.0.26
Falling receiver propagation delay	t_{RXPDF}	–	–	6	μs	⁷⁾ LIN 2.1 Param 31	P_7.2.0.27
Receiver propagation delay symmetry (rising edge versus falling edge)	dt_{RXPD}	-2	–	2	μs	⁷⁾ LIN 2.1 Param 32	P_7.2.0.28

LIN interface

- 1) Not subject to production test.
- 2) Bus loading conditions ($C_{LIN}; R_{LIN}$) = (1 nF; 1 k Ω), (6.8 nF; 660 Ω) and (10 nF; 500 Ω). For signal specification, refer to **Figure 14 “LIN signal specification” on Page 48**.
- 3) $V_{LIN,d2r} = 0.744 \times V_{SUP}$, $V_{LIN,r2d} = 0.581 \times V_{SUP}$, $V_{SUP} = 7 \text{ V to } 18 \text{ V}$, $T_{BIT} = 50 \mu\text{s}$
- 4) $V_{LIN,d2r} = 0.284 \times V_{SUP}$, $V_{LIN,r2d} = 0.422 \times V_{SUP}$, $V_{SUP} = 7.6 \text{ V to } 18 \text{ V}$, $T_{BIT} = 50 \mu\text{s}$
- 5) $V_{LIN,d2r} = 0.778 \times V_{SUP}$, $V_{LIN,r2d} = 0.616 \times V_{SUP}$, $V_{SUP} = 7 \text{ V to } 18 \text{ V}$, $T_{BIT} = 96 \mu\text{s}$
- 6) $V_{LIN,d2r} = 0.389 \times V_{SUP}$, $V_{LIN,r2d} = 0.251 \times V_{SUP}$, $V_{SUP} = 7 \text{ V to } 18 \text{ V}$, $T_{BIT} = 96 \mu\text{s}$
- 7) Wafer Test only

6.3 Message frames (data link layer)

The TLE8881-2 can communicate with both a LIN 2.1 and a LIN 1.3 master. This is realized by implementing calculations for both a classic checksum and an enhanced checksum. The selection of the supported LIN protocol can be adjusted via **NVM-LIN**.

Note: For backward compatibility reasons, a LIN 2.1 master is able to communicate with a LIN 1.3 slave but not vice versa. This backward compatibility is assured by the fact that the TLE8881-2 is designed according to LIN 2.1 on the physical layer, as recommended by the LIN consortium. Thus, and due to the NVM field switch, the TLE8881-2 can communicate with a master specified according to both LIN 2.1 as well as LIN 1.3.

Every data transfer is initiated from the master by sending a header. This header contains a synch-break field, a synch byte and a frame identifier byte (ID Byte, or labeled as Protected Identifier in the LIN 2.1 specification). The frame identifier byte defines the response which is sent by the master or the slave immediately after the LIN frame header. The response contains 1 to 8 data bytes as well as one checksum byte at the end of the LIN frame. In the communication protocol of the TLE8881-2 only 2, 4 and 8 data bytes are defined as valid responses.

Except for the synch-break field, LIN frames are byte-oriented so that the LIN specification allows a delay between bytes (interbyte delay). Every byte in a single LIN frame is composed of a start bit, 8 data bits and one stop bit. The bits are encoded with the value ‘0’ (dominant) or ‘1’ (recessive). In a bit stream of one data byte, the least significant bit (lsb) is indicated as the first arriving bit on the LIN bus, whereas the most significant bit (msb) is the last bit, respectively.

Figure 15 shows a complete LIN frame for an identifier using 4 data bytes in the response field. The synch-break field re-initializes the receiver and marks the start of a new LIN frame in any case.

LIN interface

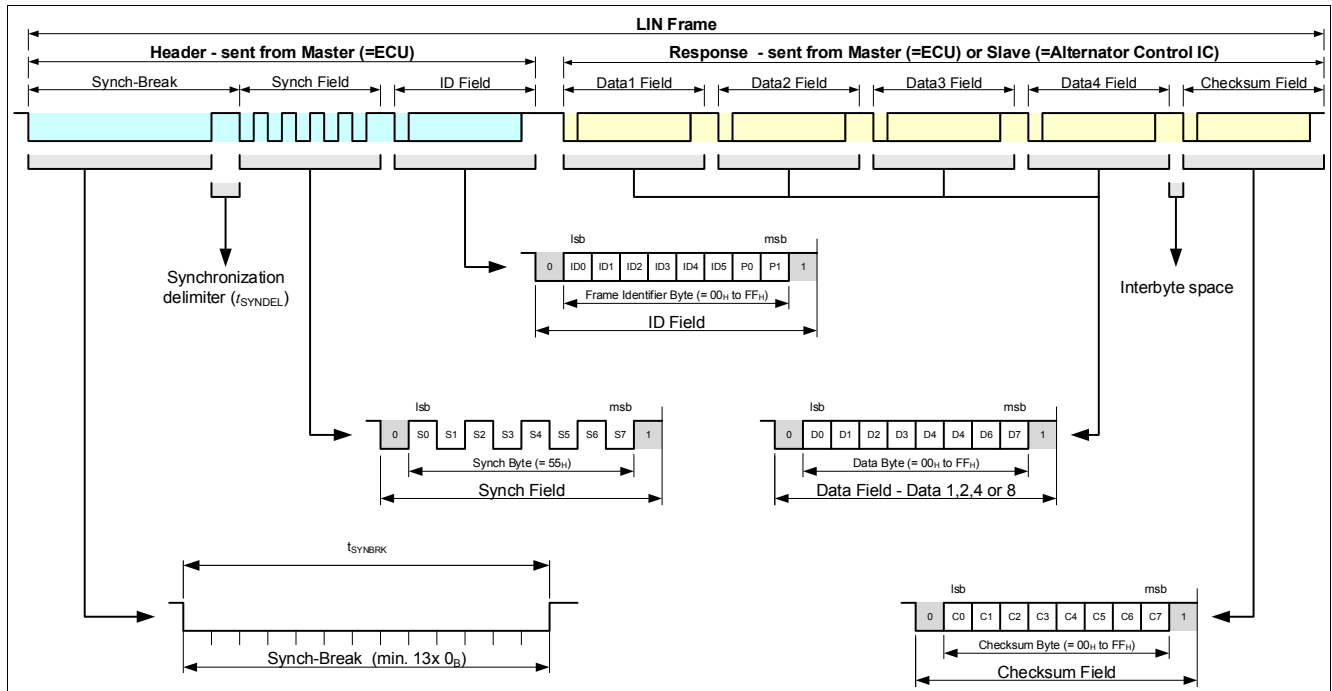

Figure 15 LIN frame

If the bus is idle (recessive) for more than $t_{LINIDLE}$, the receiver is re-initialized. That means that the synchronization delimiter or any interbyte space must not exceed $t_{LINIDLE}$ of 25.000 bit times of 19200 baud, which is 1300 ms. Otherwise the frame is lost.

The TLE8881-2 sends its response immediately after the identifier and it will not generate any delay between bytes in the response field (which results in no interbyte space).

6.3.1 LIN frame structure

Frame identifier byte / protected identifier

On principle, the LIN frame identifier byte (also know as the frame identifier field, or ID field) consists of 6 identifier bits plus 2 parity bits. The coverage of having no pattern with all bits recessive or dominant can be guaranteed by the 2 parity bits inside the frame identifier field (ID field). The first parity bit is calculated by the XOR-concatenation between ID bits as indicated in [Equation \(6.1\)](#).

(6.1)

$$P0 = ID0 \oplus ID1 \oplus ID2 \oplus ID4$$

The second parity bit is computed by the inverse XOR-concatenation between ID bits as indicated in [Equation \(6.2\)](#).

(6.2)

$$P1 = ID1 \oplus ID3 \oplus ID4 \oplus ID5$$

Thus, the frame identifier byte never consists of 0's or 1's only and can be distinguished easily from the synchronizer break.

LIN interface

Checksum byte

For the LIN 1.3 data link layer (EEPROM field **NVM-LIN** = 1_B), a classic checksum calculation is used which means inverting the sum of modulo 256 (with carry) of all data bytes. An eight bit sum with carry is equivalent to the sum of all values from which 255 is subtracted every time the sum is greater, or equal to 256.

For the LIN 2.1 data link layer (EEPROM field **NVM-LIN** = 0_B), an enhanced checksum calculation is used which additionally includes the Protected Identifier Field (Identifier Byte including parity bits) in the sum of all data bytes.

According to the LIN specification, if the ID field is 3C_H or 3D_H, the classic checksum calculation will always be used.

Examples for checksum calculation are given in the respective LIN specification documents.

Data byte

Every LIN frame is named with a unique symbol, starting with “R” for received frames (from the LIN master, also called request frames) and starting with “T” for transmitted frames (from the LIN master, also called response frames). The “P” indicates fields or frames only used if test mode is active.

TLE8881-2 supports the following data byte structures which can be chosen in NVM via **NVM-CFG**:

- VDA-A variant
- VDA-B variant
- OEM1 variant
- OEM2 variant

6.3.2 LIN frame identifier recommendations

The TLE8881-2 supports the flexible configuration of the LIN Frame Identifiers. The identifiers can be configured via an EEPROM configuration of the fields **NVM-LINRX**, **NVM-LINTX1**, **NVM-LINTX2**, **NVM-LINTX3** (refer to **Chapter 9.2.1**). **Table 55** provides recommended examples of the EEPROM configuration for reference purposes. Since the parity can be calculated via **Equation (6.1)** and **Equation (6.2)**, the EEPROM configuration excludes the parity bits from the resulting byte.

The LIN identifier for diagnostic frames is ignored for LIN 1.3 (**NVM-LIN** = 1_B) if **NVM-3Ddis** = 1_B. If the TLE8881-2 is configured for LIN 2.1 (**NVM-LIN**=0_B), it will send the specified response (see **Chapter 6.7**).

The frames **NVM-LINTX1**, **NVM-LINTX2** and **NVM-LINTX3** can be deactivated by programming the frame ID in the NVM to 0x3C. The TLE8881-2 will not answer to the TX frames and respond to 0x3C with the 0x3C diagnostic frame.

Table 55 LIN frame identifier

TLE8881-2 configuration	Symbol / comment	Identifier byte									Data bytes			
		Byte	Identifier bits							Parity		Result byte	Length	Sent by
			Bit 0	Bit 1	Bit 2	Bit 3	Bit 4	Bit 5	P0	P1				
All ¹⁾	Diagnostic frame (sleep command / programming)	3C _H	0	0	1	1	1	1	0	0	3C _H	8	Master	
All	Diagnostic frame ²⁾	3D _H	1	0	1	1	1	1	1	0	7D _H	8	TLE8881-2	

LIN interface

Table 55 LIN frame identifier (cont'd)

TLE8881-2 config- uration	Symbol / comment	Identifier byte										Data bytes		
		Identifier bits								Parity		Result byte	Length	Sent by
		Byte	Bit 0	Bit 1	Bit 2	Bit 3	Bit 4	Bit 5	P0	P1				
VDA-A config for regulator #1	RX ³⁾	29_H	1	0	0	1	0	1	1	1	E9_H	4	Master	
	TX1	11_H	1	0	0	0	1	0	0	0	11_H	2	TLE8881-2	
	TX2	12_H	0	1	0	0	1	0	0	1	92_H	2	TLE8881-2	
	TX3 ³⁾	15_H	1	0	1	0	1	0	1	0	55_H	4	TLE8881-2	
VDA-A config for regulator #2 ⁴⁾	RX ³⁾	2A_H	0	1	0	1	0	1	1	0	6A_H	4	Master	
	TX1	13_H	1	1	0	0	1	0	1	1	D3_H	2	TLE8881-2	
	TX2	14_H	0	0	1	0	1	0	0	0	14_H	2	TLE8881-2	
	TX3 ³⁾	16_H	0	1	1	0	1	0	1	1	D6_H	4	TLE8881-2	
OEM1 / VDA-B config for regulator #1	RX ³⁾	29_H	1	0	0	1	0	1	1	1	E9_H	4	Master	
	TX1	-	-	-	-	-	-	-	-	-	-		-	
	TX2	12_H	0	1	0	0	1	0	0	1	92_H	2	TLE8881-2	
	TX3 ³⁾	15_H	1	0	1	0	1	0	1	0	55_H	4	TLE8881-2	
OEM1 / VDA-B config for regulator #2 ⁴⁾	RX ³⁾	2A_H	0	1	0	1	0	1	1	0	6A_H	4	Master	
	TX1	-	-	-	-	-	-	-	-	-	-		-	
	TX2	14_H	0	0	1	0	1	0	0	0	14_H	2	TLE8881-2	
	TX3 ³⁾	16_H	0	1	1	0	1	0	1	1	D6_H	4	TLE8881-2	
OEM2 config for regulator #1	RX ³⁾	29_H	1	0	0	1	0	1	1	1	E9_H	4	Master	
	TX1	-	-	-	-	-	-	-	-	-	-		-	
	TX2	-	-	-	-	-	-	-	-	-	-		-	
	TX3 ³⁾	21_H	1	0	0	0	0	1	1	0	61_H	4	TLE8881-2	
OEM2 config for regulator #2 ⁴⁾	RX ³⁾	2A_H	0	1	0	1	0	1	1	0	6A_H	4	Master	
	TX1	-	-	-	-	-	-	-	-	-	-		-	
	TX2	-	-	-	-	-	-	-	-	-	-		-	
	TX3 ³⁾	22_H	0	1	0	0	0	1	1	1	E2_H	4	TLE8881-2	
TLE8881 ⁵⁾ config for regulator #1	RX ³⁾	20_H	0	0	0	0	0	1	0	0	20_H	4	Master	
	TX1	15_H	1	0	1	0	1	0	1	0	55_H	2	TLE8881-2	
	TX2	21_H	1	0	0	0	0	1	1	0	61_H	2	TLE8881-2	
	TX3 ³⁾	18_H	0	0	0	1	1	0	1	1	D8_H	4	TLE8881-2	
TLE8881 config for regulator #2 ⁴⁾	RX ³⁾	2A_H	0	1	0	1	0	1	1	0	6A_H	4	Master	
	TX1	13_H	1	1	0	0	1	0	1	1	D3_H	2	TLE8881-2	
	TX2	11_H	1	0	0	0	1	0	0	0	11_H	2	TLE8881-2	
	TX3 ³⁾	16_H	0	1	1	0	1	0	1	1	D6_H	4	TLE8881-2	

1) The sleep mode command (ID byte = 3C_H, data byte 1 = 00_H) is only accepted by the TLE8881-2 in the states “ComActive” and “pre-excitation”.

2) LIN identifier ignored for LIN 1.3 (NVM-LIN = 1_B AND NVM-3Ddis = 1_B). LIN identifier responded by TLE8881-2 for LIN 2.1 (NVM-LIN = 0_B).

LIN interface

- 3) These frames are also used for test purposes and NVM programming.
- 4) For the use in LIN networks with two alternators.
- 5) The TLE8881-2 can be configured to have the same LIN ID as the legacy product TLE8881. For the same operation as the TLE8881, the NVM configuration has to be adapted to match the TLE8881 configuration.

6.3.3 LIN RX frame

This chapter describes the content of the different LIN RX frames (request/command from the LIN master to the TLE8881-2). The mapping between the LIN frame content and the internal register assignments is described in [Chapter 6.4](#).

Except in case of a test mode entry detection, all bits in the frame RX which are not covered by any information field are ignored by the TLE8881-2.

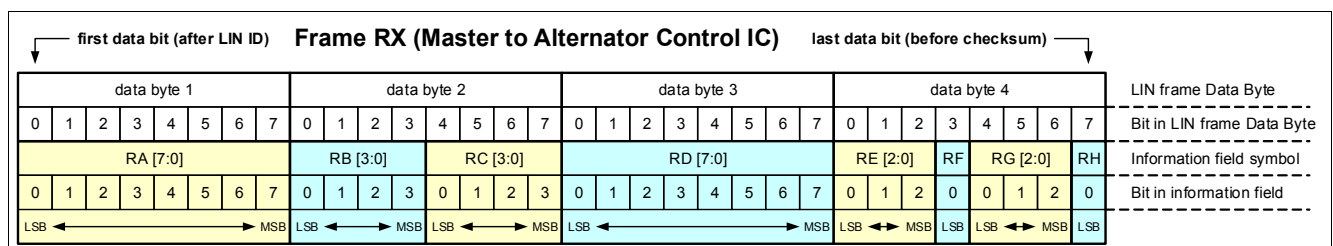

Figure 16 Frame RX

Table 56 Information fields of the frame RX

Symbol	Bits	Description	TLE8881-2 register
RA	8	Regulation voltage setpoint for VDA-A and OEM2 variants	RVSET[7:2] := RA[5:0] RVSET[1:0] := 00 _B
		Regulation voltage setpoint for VDA-B and OEM1 variants	RVSET[7:0] := RA[7:0]
RB	4	LRC rise time (positive gradient)	RLRCRT[3:0]
RC	4	LRC disable frequency	RLRCDIS[3:0]
RD	8	Excitation current limitation for VDA-A variant	RCLIM[4:0] := RD[4:0] RCLIM[7:5] := 000 _B
		Excitation current limitation for VDA-B and OEM1 variants	RCLIM[6:0] := RD[7:1]
		Excitation current limitation for OEM2 variant	RCLIM[7:0] := RD[7:0]
RE	3	Response data indicator for OEM1, VDA-A and VDA-B and variants (Chapter 6.4.7)	RDI[2:0] := RE[2:0]
		Response data indicator for OEM2 variant (Chapter 6.4.7)	RE[2:0] reserved ¹⁾ RDI[2:0] := 000 _B
RF	1	LRC blind zone for OEM1, VDA-A and VDA-B variants	RLRCBZ := RF
		LRC blind zone for OEM2 variant	RF ignored (NVM-LRCBZ is used)
RG	3	Offset of the threshold for the high temperature regulation for OEM1, VDA-A and VDA-B variants	RHT[2:0] := RG[2:0]
		Offset of the threshold for the high temperature regulation for OEM2 variant	RG[2:0] ignored (RHT[2:0] := 000)
RH	1	Activation of F-Para function (Chapter 5.14).	F PARA := RH

1) Used for Test Mode

LIN interface

6.3.4 LIN TX1 frame

The chapter describes the content of the LIN TX1 frame (information response from the TLE8881-2 to the LIN master). The mapping between the LIN frame content and the internal register assignments is described in [Chapter 6.4](#).

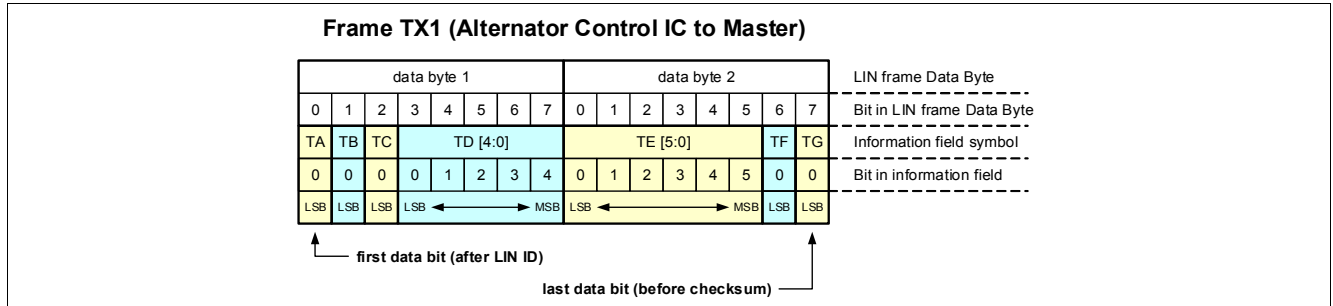

Figure 17 Frame TX1

Diagnosis flags F-HT, F-ROT, F-EL, F-CEF and F-CTO mentioned in [Table 57](#) are described in [Chapter 4.5](#).

Table 57 Information fields of the frame TX1

Symbol	Bits	Description	TLE8881-2 register
TA	1	Diagnosis flag F-HT (high temperature indication flag)	Diagnosis flag
TB	1	Diagnosis flag F-ROT (mechanical abnormality flag)	Diagnosis flag
TC	1	Diagnosis flag F-EL (electrical abnormality flag)	Diagnosis flag
TD	5	Duty cycle value of the excitation PWM (field monitoring)	RDC[4:0]
TE	6	Measured excitation current	RMC6[5:0]
TF	1	Diagnosis flag F-CEF (LIN communication error flag)	Diagnosis flag
TG	1	Diagnosis flag F-CTO (LIN communication time-out flag)	Diagnosis flag

6.3.5 LIN TX2 frame

The chapter describes the content of the LIN TX2 frame (information response from the TLE8881-2 to the LIN master). The mapping between the LIN frame content and the internal register assignments is described in [Chapter 6.4](#).

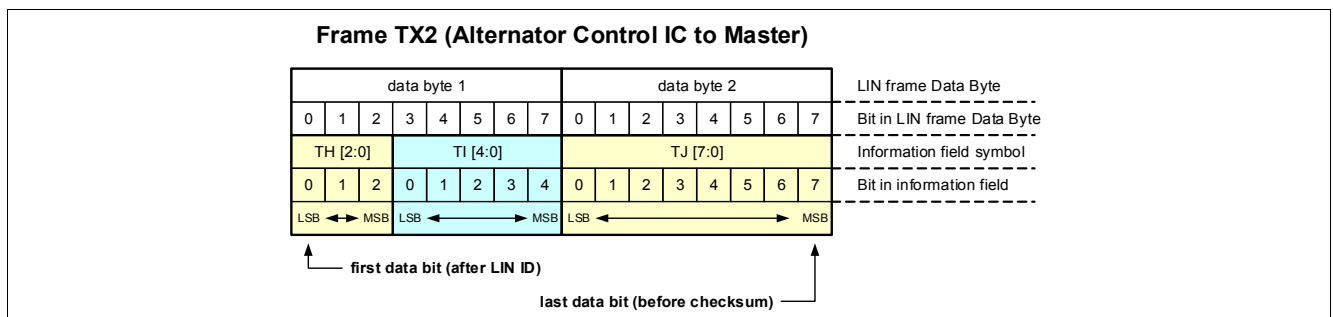

Figure 18 Frame TX2

LIN interface

Table 58 Information fields of the frame TX2

Symbol	Bits	Description	TLE8881-2 register
TH	3	Alternator supplier identification	RSUPP[2:0]
TI	5	Alternator class identification	RCLASS[4:0]
TJ [2:0]	3	Manufacturer ID: Infineon = 001 _B	–
TJ [7:3]	5	ASIC ID: B11, B12 = 00011 _B	–

6.3.6 LIN TX3 frame

The chapter describes the content of the LIN TX3 frame (information response from the TLE8881-2 to the LIN master). The mapping between the LIN frame content and the internal register assignments is described in [Chapter 6.4](#).

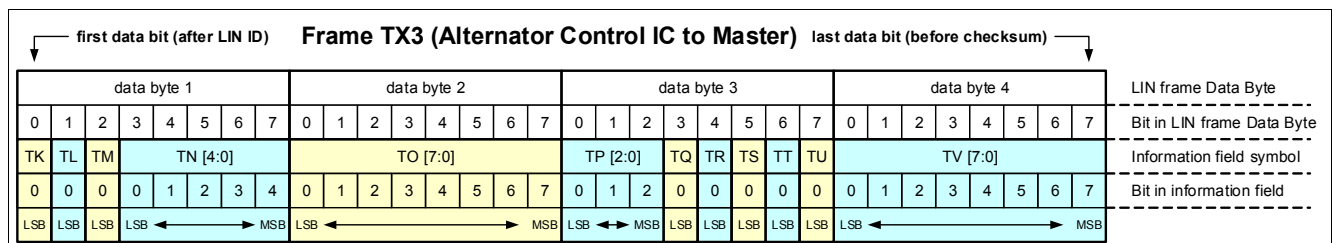

Figure 19 Frame TX3

All bits in the LIN TX3 frame which are not covered by any information field are set to ‘0’ (dominant) by the TLE8881-2.

The diagnosis flags F-HT, F-ROT, F-EL, F-CEF and F-CTO mentioned in [Table 59](#) are described in [Chapter 4.5](#).

Table 59 Information fields of the frame TX3 for OEM1, VDA-A and VDA-B and variants

Symbol	Bits	Description	TLE8881-2 register
TK	1	Diagnosis flag F-HT (high temperature indication flag)	Diagnosis flag
TL	1	Diagnosis flag F-ROT (mechanical abnormality flag)	Diagnosis flag
TM	1	Diagnosis flag F-EL (electrical abnormality flag)	Diagnosis flag
TN	5	Duty cycle value of the excitation PWM (field monitoring)	RDC[4:0]
TO	8	Measured excitation current	RMC8[7:0]
TP	3	Data Indicator for TX3 frame byte 4	RDI[2:0] (Chapter 6.4.7)
TQ	1	Reserved; TQ := 0 _B	
TR	1	Reserved; TR := 0 _B	
TS	1	Reserved; TS := 0 _B	
TT	1	Diagnosis flag F-CEF (LIN communication error flag)	Diagnosis flag
TU	1	Diagnosis flag F-CTO (LIN communication time-out flag)	Diagnosis flag
TV	8	Multiplex byte to represent measured voltage / Measured temperature / Measured speed / Voltage set point	RMV[7:0] / RMT[7:0] / RMS[7:0] / RVSET [7:0]

LIN interface

Table 60 Information fields of the frame TX3 for OEM2 variant

Symbol	Bits	Description	TLE8881-2 register
TK	1	Diagnosis flag F-HT (high temperature indication flag)	Diagnosis flag
TL	1	Diagnosis flag F-ROT (mechanical abnormality flag)	Diagnosis flag
TM	1	Diagnosis flag F-EL (electrical abnormality flag)	Diagnosis flag
TN	5	Duty cycle value of the excitation PWM (field monitoring)	RDC[4:0]
TO	8	Measured excitation current	RMC8[7:0]
TP	3	Reserved; TP := 000 _B	
TQ	1	Reserved; TQ := 0 _B	
TR	1	Reserved; TR := 0 _B	
TS	1	Reserved; TS := 0 _B	
TT	1	Diagnosis flag F-CEF (LIN communication error flag)	Diagnosis flag
TU	1	Diagnosis flag F-CTO (LIN communication time-out flag)	Diagnosis flag
TV		Measured temperature	RMT[7:0]

6.4 LIN registers

The LIN registers are used as the data interface between the ECU and the TLE8881-2. The transmission of information from the data interface is done via the LIN interface. A specific set of registers is writable and defines the functional behavior of the TLE8881-2. Another set of registers is readable by the master and can be used to monitor some kind of information.

For the register content after a wake-up from stand-by mode, after a logic reset and the state “default operation”, see [Chapter 6.5](#).

6.4.1 Register RVSET (voltage setpoint)

The writable internal register RVSET defines the setpoint of the regulation voltage (control parameter VSET). The operation range is between 10.6 V and 16 V. The ECU can modify this register by using the LIN data field RA. The actually applied voltage setpoint VSET can be limited by the Low HEO and TSC functions and does not always match the value in the RVSET register.

While switching between the relevant states of the state machine, the VSET transition slopes are defined in [Table 61](#) are applied.

Table 61 Transition slopes of RVSET between states

Exit from state	Entry into state	RVSET transition slope
Default operation	Normal operation	0 V/s (no transition slope)
Default operation	Excitation-Off	0 V/s (no transition slope)
Normal operation	Default operation	0.2 V/s
Excitation-Off	Normal operation	0 V/s (no transition slope)
Excitation-Off	Default operation	0.2 V/s

The LIN frame variants “VDA-B” and “OEM1” offer the full resolution of typically 25 mV (refer to [Table 63](#)). In the frame variants for “VDA-A” and “OEM2”, the most significant 2 bits of RA are always “00_B”, so that RVSET[1:0] := 00_B). Therefore this configuration only uses a setpoint resolution of typically 100 mV (refer to [Table 62](#)).

LIN interface

For further information on the voltage regulation at high temperatures see [Section 5.5](#).

Table 62 Parameter “voltage setpoint” for “VDA-A” and “OEM2” variants

Parameter	Symbol	Values			Unit	Note or Test Condition	Number
		Min	Typ.	Max			
Voltage regulation setpoint	VSET	–	$VSET := 10.6\text{ V} + RVSET * 0.1\text{ V}$	–	V	$T_J < T_{HT}$ and RVSET in range 0 to 54	P_7.4.1.1
Voltage regulation setpoint	VSET	–	$VSET := 16\text{ V}$	–	V	$T_J < T_{HT}$ and RVSET > 54	P_7.4.1.2

Table 63 Parameter “Voltage Setpoint” in “VDA-B” and “OEM1” variants

Parameter	Symbol	Values			Unit	Note or Test Condition	Number
		Min	Typ.	Max			
Voltage regulation setpoint	VSET	–	$VSET := 10.6\text{ V} + RVSET * 0.025\text{ V}$	–	V	$T_J < T_{HT}$ and RVSET in range 0 to 216	P_7.4.1.3
Voltage regulation setpoint	VSET	–	$VSET := 16\text{ V}$	–	V	$T_J < T_{HT}$ and RVSET > 216	P_7.4.1.4

6.4.2 RVSET reporting via LIN

The VSET can be reported in the LIN frame TX3.

The VSET reporting via LIN can be selected:

- The VSET received by the LIN command is reported if **NVM-VSET_report** = 0_B
- The applied VSET for the internal regulation is reported if **NVM-VSET_report** = 1_B

The applied VSET can be lower than the VSET sent via LIN if the TSC function reduces the setpoint due to high temperatures.

6.4.3 Registers LRC (load response control)

The writable internal registers RLRCBZ, RLRCRT and RLRCDIS define the behavior of the LRC function and can be modified by the ECU via the LIN interface. For a detail description of the LRC (Load Response Control) refer to [Chapter 5.12](#).

The ECU can modify these registers by using the LIN data fields RB, RC and RF, respectively.

Register implementation for LRC blind zone is indicated in [Table 64](#).

LIN interface

Table 64 Parameter “LRC blind zone”

Parameter	Symbol	Values			Unit	Note or Test Condition	Number
		Min.	Typ.	Max.			
LRC blind zone	LRCBZ	–	Register RLRCBZ = 0	–	–	Blind zone = 3%/6.25%, depending on NVM option “LRCBZ_0_SEL”	P_7.4.2.1
LRC blind zone	LRCBZ	–	Register RLRCBZ = 1	–	–	Blind zone = 12%	P_7.4.2.2

The register implementation for the LRC Rise Time for the “VDA-A” LIN frame variant is shown in [Table 65](#), whereas for “VDA-B”, “OEM2” and “OEM1” it is stated in [Table 66](#).

Table 65 Parameter “LRC rise time” in “VDA-A” variant

Parameter	Symbol	Values			Unit	Note or Test Condition	Number
		Min.	Typ.	Max.			
LRC rise time(0% up to 100%)	LRCRT	–	LRC disabled	–	s	0000	P_7.4.2.3
LRC rise time(0% up to 100%)	LRCRT	–	1	–	s	0001	P_7.4.2.4
LRC rise time(0% up to 100%)	LRCRT	–	2	–	s	0010	P_7.4.2.5
LRC rise time(0% up to 100%)	LRCRT	–	3	–	s	0011	P_7.4.2.6
LRC rise time(0% up to 100%)	LRCRT	–	4	–	s	0100	P_7.4.2.7
LRC rise time(0% up to 100%)	LRCRT	–	5	–	s	0101	P_7.4.2.8
LRC rise time(0% up to 100%)	LRCRT	–	6	–	s	0110	P_7.4.2.9
LRC rise time(0% up to 100%)	LRCRT	–	7	–	s	0111	P_7.4.2.10
LRC rise time(0% up to 100%)	LRCRT	–	8	–	s	1000	P_7.4.2.11
LRC rise time(0% up to 100%)	LRCRT	–	9	–	s	1001	P_7.4.2.12
LRC rise time(0% up to 100%)	LRCRT	–	10	–	s	1010	P_7.4.2.13
LRC rise time(0% up to 100%)	LRCRT	–	11	–	s	1011	P_7.4.2.14
LRC rise time(0% up to 100%)	LRCRT	–	12	–	s	1100	P_7.4.2.15
LRC rise time(0% up to 100%)	LRCRT	–	13	–	s	1101	P_7.4.2.16

LIN interface

Table 65 Parameter “LRC rise time” in “VDA-A” variant (cont'd)

Parameter	Symbol	Values			Unit	Note or Test Condition	Number
		Min.	Typ.	Max.			
LRC rise time(0% up to 100%)	LRCRT	–	14	–	s	1110	P_7.4.2.17
LRC rise time(0% up to 100%)	LRCRT	–	15	–	s	1111	P_7.4.2.18

Table 66 Parameter “LRC rise time” in “VDA-B”, “OEM2” and “OEM1” variants

Parameter	Symbol	Values			Unit	Note or Test Condition	Number
		Min.	Typ.	Max.			
LRC rise time(0% up to 100%)	LRCRT	–	LRC disabled	–	s	0000	P_7.4.2.19
LRC rise time(0% up to 100%)	LRCRT	–	0.28	–	s	0001	P_7.4.2.20
LRC rise time(0% up to 100%)	LRCRT	–	0.5	–	s	0010	P_7.4.2.21
LRC rise time(0% up to 100%)	LRCRT	–	0.75	–	s	0011	P_7.4.2.22
LRC rise time(0% up to 100%)	LRCRT	–	1	–	s	0100	P_7.4.2.23
LRC rise time(0% up to 100%)	LRCRT	–	2	–	s	0101	P_7.4.2.24
LRC rise time(0% up to 100%)	LRCRT	–	3	–	s	0110	P_7.4.2.25
LRC rise time(0% up to 100%)	LRCRT	–	4	–	s	0111	P_7.4.2.26
LRC rise time(0% up to 100%)	LRCRT	–	5	–	s	1000	P_7.4.2.27
LRC rise time(0% up to 100%)	LRCRT	–	6	–	s	1001	P_7.4.2.28
LRC rise time(0% up to 100%)	LRCRT	–	7	–	s	1010	P_7.4.2.29
LRC rise time(0% up to 100%)	LRCRT	–	8	–	s	1011	P_7.4.2.30
LRC rise time(0% up to 100%)	LRCRT	–	9	–	s	1100	P_7.4.2.31
LRC rise time(0% up to 100%)	LRCRT	–	10	–	s	1101	P_7.4.2.32
LRC rise time(0% up to 100%)	LRCRT	–	12	–	s	1110	P_7.4.2.33
LRC rise time(0% up to 100%)	LRCRT	–	15	–	s	1111	P_7.4.2.34

LIN interface

Register implementation for LRC disable speed is indicated in [Table 67](#).

Table 67 Parameter “LRC disable speed”

Parameter	Symbol	Values			Unit	Note or Test Condition	Number
		Min.	Typ.	Max.			
LRC disable rotor speed	n_{LRCDIS}	–	2400	–	rpm	0000	P_7.4.2.35
LRC disable rotor speed	n_{LRCDIS}	–	2530	–	rpm	0001	P_7.4.2.36
LRC disable rotor speed	n_{LRCDIS}	–	2670	–	rpm	0010	P_7.4.2.37
LRC disable rotor speed	n_{LRCDIS}	–	2830	–	rpm	0011	P_7.4.2.38
LRC disable rotor speed	n_{LRCDIS}	–	3000	–	rpm	0100	P_7.4.2.39
LRC disable rotor speed	n_{LRCDIS}	–	3200	–	rpm	0101	P_7.4.2.40
LRC disable rotor speed	n_{LRCDIS}	–	3430	–	rpm	0110	P_7.4.2.41
LRC disable rotor speed	n_{LRCDIS}	–	3690	–	rpm	0111	P_7.4.2.42
LRC disable rotor speed	n_{LRCDIS}	–	4000	–	rpm	1000	P_7.4.2.43
LRC disable rotor speed	n_{LRCDIS}	–	4360	–	rpm	1001	P_7.4.2.44
LRC disable rotor speed	n_{LRCDIS}	–	4790	–	rpm	1010	P_7.4.2.45
LRC disable rotor speed	n_{LRCDIS}	–	5320	–	rpm	1011	P_7.4.2.46
LRC disable rotor speed	n_{LRCDIS}	–	5990	–	rpm	1100	P_7.4.2.47
LRC disable rotor speed	n_{LRCDIS}	–	6860	–	rpm	1101	P_7.4.2.48
LRC disable rotor speed	n_{LRCDIS}	–	8010	–	rpm	1110	P_7.4.2.49
LRC disable rotor speed	n_{LRCDIS}	–	LRC not disabled by rotor speed	–	rpm	1111	P_7.4.2.50

6.4.4 Register RCLIM (excitation current limitation)

The writable internal register RCLIM defines the limitation value of the excitation current.

While switching between the relevant states of the state machine, RCLIM transition slopes as defined in [Table 68](#) are applied.

LIN interface

Table 68 Transition slopes of RCLIM between states

Exit from state	Entry into state	RCLIM transition slope
Normal operation	Default operation	0.375 A/s

If the limitation is removed or increased, a positive jump of the duty cycle value can occur. If LRC is enabled, LRC becomes active to avoid changes of torque.

The mapping between RCLIM and CLIM for the “VDA-A” variant is stated in [Table 69](#), whereas for the “VDA-B” and “OEM1” variants it is given in [Table 70](#). The “OEM2” variant is stated in [Table 71](#).

Table 69 Parameter “excitation current limitation” for “VDA-A” variant

Parameter	Symbol	Values			Unit	Note or Test Condition	Number
		Min.	Typ.	Max.			
Register current limitation	RCLIM	0	–	31	–	–	P_7.4.3.1
Excitation current limitation	CLIM	–	RCLIM disabled	–	A	Normal operation and RCLIM = 0 ¹⁾	P_7.4.3.2
Excitation current limitation	CLIM	–	2 A	–	A	Normal operation and RCLIM < 9 ¹⁾	P_7.4.3.3
Excitation current limitation	CLIM	–	CLIM := RCLIM * 0.25 A	–	A	Normal operation and 9 ≤ RCLIM ≤ 31 ¹⁾	P_7.4.3.4
Excitation current limitation	CLIM	–	No current limitation	–	A	Default operation ¹⁾	P_7.4.3.5

1) The shown values don't include the current measurement tolerance.

Table 70 Parameter “excitation current limitation” for “VDA-B” and “OEM1” variants

Parameter	Symbol	Values			Unit	Note or Test Condition	Number
		Min.	Typ.	Max.			
Register current limitation	RCLIM	0	–	127	–	–	P_7.4.3.6
Excitation current limitation	CLIM	–	RCLIM disabled	–	A	Normal operation and RCLIM = 0 ¹⁾	P_7.4.3.7
Excitation current limitation	CLIM	–	CLIM := RCLIM * 0.1 A	–	A	Normal operation and 0 < RCLIM ≤ 110 ¹⁾	P_7.4.3.8
Excitation current limitation	CLIM	–	No current limitation	–	A	Normal operation and RCLIM > 110 ¹⁾	P_7.4.3.9
Excitation current limitation	CLIM	–	No current limitation	–	A	Default operation ¹⁾	P_7.4.3.10

1) The shown values don't include the current measurement tolerance.

LIN interface

Table 71 Parameter “excitation current limitation” for “OEM2” variant

Parameter	Symbol	Values			Unit	Note or Test Condition	Number
		Min.	Typ.	Max.			
Register current limitation	RCLIM	0	–	255	-	–	P_7.4.3.11
Excitation current limitation	CLIM	–	RCLIM disabled	–	A	Normal operation and RCLIM = 0 ¹⁾	P_7.4.3.12
Excitation current limitation	CLIM	–	CLIM := RCLIM * 0.04 A	–	A	Normal operation and 0 < RCLIM ≤ 255 ¹⁾	P_7.4.3.13
Excitation current limitation	CLIM	–	No current limitation	–	A	Default operation ¹⁾	P_7.4.3.14

1) The shown values don't include the current measurement tolerance.

6.4.5 Register RFPARA (F-Para function)

The writable internal register RFPARA allows the activation of the pre-selected regulation parameter set (Ki and Kp factors of the PI regulation loop) as defined in [NVM-RPARA_SEL](#). During normal operation state (LIN communication available), the ECU can modify this register by using the LIN data field RH in the LIN RX frame. For a detailed description of this function refer to [Chapter 5.14](#).

Table 72 Parameter “F-Para regulation parameters”

Parameter	Symbol	Values			Unit	Note or Test Condition	Number
		Min.	Typ.	Max.			
F-Para regulation parameters	FPARA	–	RFPARA	–	–	Normal dynamic regulation behavior: RFPARA = 0;	P_7.4.4.1
F-Para regulation parameters	FPARA	–	RFPARA	–	–	Normal dynamic regulation behavior: RFPARA = 1; NVM-RPARA_SEL = 11 _B	P_7.4.4.2
F-Para regulation parameters	FPARA	–	RFPARA	–	–	Slow dynamic regulation behavior: RFPARA = 1; NVM-RPARA_SEL = 10 _B	P_7.4.4.3
F-Para regulation parameters	FPARA	–	RFPARA	–	–	Slower dynamic regulation behavior: RFPARA = 1; NVM-RPARA_SEL = 01 _B	P_7.4.4.4
F-Para regulation parameters	FPARA	–	RFPARA	–	–	Slowest dynamic regulation behavior: RFPARA = 1; NVM-RPARA_SEL = 00 _B	P_7.4.4.5

LIN interface

6.4.6 Register RHT (adjustment of high temperature threshold)

The writable internal register RHT allows an adjustment of the T_{HT} high temperature behavior as mentioned in the Temperature Setpoint Compensation (see [Chapter 5.6](#)).

The related mapping is stated in [Table 73](#).

Table 73 Parameter “HT adjustment”

Parameter	Symbol	Values			Unit	Note or Test Condition	Number
		Min.	Typ.	Max.			
HT adjustment	HTADJ	–	0	–	°C	Register RHT[2:0] := 000	P_7.4.5.1
HT adjustment	HTADJ	–	-16	–	°C	Register RHT[2:0] := 001	P_7.4.5.2
HT adjustment	HTADJ	–	-12	–	°C	Register RHT[2:0] := 010	P_7.4.5.3
HT adjustment	HTADJ	–	-8	–	°C	Register RHT[2:0] := 011	P_7.4.5.4
HT adjustment	HTADJ	–	-4	–	°C	Register RHT[2:0] := 100	P_7.4.5.5
HT adjustment	HTADJ	–	+4	–	°C	Register RHT[2:0] := 101	P_7.4.5.6
HT adjustment	HTADJ	–	+8	–	°C	Register RHT[2:0] := 110	P_7.4.5.7
HT adjustment	HTADJ	–	+12	–	°C	Register RHT[2:0] := 111	P_7.4.5.8

6.4.7 Register RDI (response data indicator)

The data field TV[7:0] in the LIN frame TX3 is dependant on the data response indicator RDI sent in the LIN frame RX.

Table 74 Response Data Indicator Coding

LIN frame RX, RE[2:0]	Function	LIN frame TX3, TP[2:0]	LIN frame TX3, TV[7:0]
000 _B	LRCBZ, RHT and F-Para set to default ¹⁾	000 _B	00000000 _B
001 _B	As requested in RX-Frame	001 _B	RVSET (see Chapter 6.4.1)
010 _B	As requested in RX-Frame	010 _B	RMV (see Chapter 6.4.11)
011 _B	As requested in RX-Frame	011 _B	RMT (see Chapter 6.4.10) ²⁾
100 _B	As requested in RX-Frame	100 _B	RMS (see Chapter 6.4.12)
101 _B	Reserved for Infineon; Function settings as requested in the last valid RX-Frame.	101 _B	00000000 _B
110 _B	Used for special PRX frame;	110 _B	00000000 _B
111 _B	LRCBZ, RHT and F-Para set to default ¹⁾	111 _B	00000000 _B

1) If RDI=000_B or RDI=111_B, the F-Para function is set to default (“0”) and any F-PARA=“1” in the LIN-RX frame is ignored.

LIN interface

- 2) RDI internally adjusted to 011_B , if OEM2 variant is active (NVM-CFG = 11_B). However, via LIN communication, RDI := 000_B is reported.

6.4.8 Register RDC (excitation PWM duty cycle)

The readable internal register RDC shows the excitation PWM duty cycle (DC). The ECU can monitor this register by using the LIN data fields TD and TN.

The register RDC as provided via LIN can be filtered using a dedicated EWMA filter (refer to [Chapter 6.6.1](#)).

Table 75 Parameter “excitation duty cycle”

Parameter	Symbol	Values			Unit	Note or Test Condition	Number
		Min.	Typ.	Max.			
Excitation PWM duty cycle	DC	–	$n * 100\%/32 \leq DC < (n+1) * 100\%/32$	–	–	Register RDC[4:0] = n	P_7.4.7.1

6.4.9 Register RMC (measured excitation current)

The readable internal register RMC[7:0] shows the measured excitation current.

The ECU can monitor this register by using the respective LIN data fields TE[5:0] (RMC6) in LIN TX1 frame as well as TO[7:0] (RMC8) in LIN TX3 frame.

The register RMC as provided via LIN can be filtered using a dedicated EWMA filter (refer to [Chapter 6.6.3](#)).

Table 76 Parameter “measured excitation current” in “VDA-A” variant

Parameter	Symbol	Values			Unit	Note or Test Condition	Number
		Min.	Typ.	Max.			
Measured excitation current	MC	–	$RMC6 * 0.125$	–	A	$0 \leq RMC6 \leq 63$	P_7.4.8.1

Table 77 Parameter “measured excitation current” in “OEM1” and “VDA-B” variants

Parameter	Symbol	Values			Unit	Note or Test Condition	Number
		Min.	Typ.	Max.			
Measured excitation current	MC	–	$RMC8 * 0.05$	–	A	$0 \leq RMC8 \leq 255$	P_7.4.8.3

Table 78 Parameter “measured excitation current” in “OEM2” variant

Parameter	Symbol	Values			Unit	Note or Test Condition	Number
		Min.	Typ.	Max.			
Measured excitation current	MC	–	$RMC8 * 0.04$	–	A	$0 \leq RMC8 \leq 255$	P_7.4.8.5

6.4.10 Register RMT (measured temperature on chip)

The readable internal register RMT[7:0] shows the measured chip temperature. For the OEM2 variant, RMT is always given in the LIN TX3 frame (Data Byte 4). For all variants except of OEM2 (VDA-A, VDA-B, OEM1), the selection of RDI[2:0] is required to choose the output of the measured temperature in the LIN TX3 frame.

LIN interface

The ECU can monitor this register by using the LIN data field TV of TX3.

Table 79 Parameter “measured temperature on chip” for OEM1, VDA-A and VDA-B variants

Parameter	Symbol	Values			Unit	Note or Test Condition	Number
		Min.	Typ.	Max			
Register measured temperature on chip	RMT	0	–	63	–	All LIN frame variants	P_7.4.9.1
Measured temperature	MT	–	-42 + RMT * 4 ≤ T _J < -38 + RMT * 4	–	°C	¹⁾	P_7.4.9.2

1) The shown values for the measured temperature on chip do not include the temperature measurement tolerance.

Table 80 Parameter “measured temperature on chip” for OEM2 variant

Parameter	Symbol	Values			Unit	Note or Test Condition	Number
		Min.	Typ.	Max			
Register measured temperature on chip	RMT	0	–	255	–	All LIN frame variants	P_7.4.9.3
Measured temperature	MT	–	-42 + RMT ≤ T _J < -41 + RMT	–	°C	¹⁾	P_7.4.9.4

1) The shown values for the measured temperature on chip do not include the temperature measurement tolerance.

6.4.11 Register RMV (measured voltage at VBA terminal)

The readable internal register RMV[7:0] shows the measured voltage VBA. It is necessary to address RDI[2:0] to select the output of the measured voltage in the LIN TX3 frame. This is only possible for the OEM1, VDA-A and VDA-B variants.

The ECU can monitor this register by using the LIN data field TV of TX3. The measurable voltage is constrained to the range of 8 V to 24 V.

The register RMV as provided via LIN can be filtered using a dedicated EWMA filter (refer to [Chapter 6.6.2](#)).

Table 81 Parameter “measured voltage at terminal VBA”

Parameter	Symbol	Values			Unit	Note or Test Condition	Number
		Min.	Typ.	Max.			
Register “measured voltage at VBA terminal”	RMV	0	–	255	-	All LIN frame variants	P_7.4.10.1
Measured voltage at VBA terminal	MV ¹⁾	Typ. value - 50 mV	8V+ RMV * 100 mV	Typ. value + 50 mV	mV	0 ≤ RMV < 161	P_7.4.10.2
Measured voltage at VBA terminal	MV	24	–	–	V	161 ≤ RMV < 255	P_7.4.10.3

1) The shown values for the voltage on terminal BA don’t include the voltage measurement tolerance.

LIN interface

6.4.12 Register RMS (measured speed)

The readable internal register RMS[7:0] shows the measured speed of the alternator in RPM. It is necessary to address RDI[2:0] to select the output of the measured speed in the LIN TX3 frame. This is only possible for the OEM1, VDA-A and VDA-B variants.

The ECU can monitor this register by using the LIN data field TV of TX3. The measurable speed is constrained to the range of 500 rpm to 25600 rpm.

There are two options to report the measured speed:

- The speed is reported in the classical way shown in **Table 82** if **NVM-RMS_report** = 0_B.
- The speed is reported with a linear function if **NVM-RMS_report** = 1_B.
 In this case RMS = measured rotation speed [rpm] / 100 rpm.

Table 82 Parameter “measured speed” for NVM-RMS_report = 0_B¹⁾

Parameter	Symbol	Values			Unit	Note or Test Condition	Number
		Min.	Typ.	Max.			
Measured speed	n_R	–	<567	–	rpm	0	P_7.4.11.1
Measured speed	n_R	–	567	–	rpm	1	P_7.4.11.2
Measured speed	n_R	–	569	–	rpm	2	P_7.4.11.3
Measured speed	n_R	–	571	–	rpm	3	P_7.4.11.4
Measured speed	n_R	–	574	–	rpm	4	P_7.4.11.5
Measured speed	n_R	–	576	–	rpm	5	P_7.4.11.6
Measured speed	n_R	–	578	–	rpm	6	P_7.4.11.7
Measured speed	n_R	–	581	–	rpm	7	P_7.4.11.8
Measured speed	n_R	–	583	–	rpm	8	P_7.4.11.9
Measured speed	n_R	–	585	–	rpm	9	P_7.4.11.10
Measured speed	n_R	–	588	–	rpm	10	P_7.4.11.11
Measured speed	n_R	–	590	–	rpm	11	P_7.4.11.12
Measured speed	n_R	–	593	–	rpm	12	P_7.4.11.13
Measured speed	n_R	–	595	–	rpm	13	P_7.4.11.14
Measured speed	n_R	–	598	–	rpm	14	P_7.4.11.15
Measured speed	n_R	–	600	–	rpm	15	P_7.4.11.16
Measured speed	n_R	–	603	–	rpm	16	P_7.4.11.17
Measured speed	n_R	–	605	–	rpm	17	P_7.4.11.18
Measured speed	n_R	–	608	–	rpm	18	P_7.4.11.19
Measured speed	n_R	–	610	–	rpm	19	P_7.4.11.20
Measured speed	n_R	–	613	–	rpm	20	P_7.4.11.21
Measured speed	n_R	–	615	–	rpm	21	P_7.4.11.22
Measured speed	n_R	–	618	–	rpm	22	P_7.4.11.23
Measured speed	n_R	–	621	–	rpm	23	P_7.4.11.24
Measured speed	n_R	–	623	–	rpm	24	P_7.4.11.25
Measured speed	n_R	–	626	–	rpm	25	P_7.4.11.26
Measured speed	n_R	–	629	–	rpm	26	P_7.4.11.27

LIN interface

Table 82 Parameter “measured speed” (cont’d) for **NVM-RMS_report = 0_B¹⁾**

Parameter	Symbol	Values			Unit	Note or Test Condition	Number
		Min.	Typ.	Max.			
Measured speed	n_R	–	632	–	rpm	27	P_7.4.11.28
Measured speed	n_R	–	634	–	rpm	28	P_7.4.11.29
Measured speed	n_R	–	637	–	rpm	29	P_7.4.11.30
Measured speed	n_R	–	640	–	rpm	30	P_7.4.11.31
Measured speed	n_R	–	643	–	rpm	31	P_7.4.11.32
Measured speed	n_R	–	646	–	rpm	32	P_7.4.11.33
Measured speed	n_R	–	649	–	rpm	33	P_7.4.11.34
Measured speed	n_R	–	652	–	rpm	34	P_7.4.11.35
Measured speed	n_R	–	655	–	rpm	35	P_7.4.11.36
Measured speed	n_R	–	658	–	rpm	36	P_7.4.11.37
Measured speed	n_R	–	661	–	rpm	37	P_7.4.11.38
Measured speed	n_R	–	664	–	rpm	38	P_7.4.11.39
Measured speed	n_R	–	667	–	rpm	39	P_7.4.11.40
Measured speed	n_R	–	670	–	rpm	40	P_7.4.11.41
Measured speed	n_R	–	673	–	rpm	41	P_7.4.11.42
Measured speed	n_R	–	676	–	rpm	42	P_7.4.11.43
Measured speed	n_R	–	679	–	rpm	43	P_7.4.11.44
Measured speed	n_R	–	682	–	rpm	44	P_7.4.11.45
Measured speed	n_R	–	686	–	rpm	45	P_7.4.11.46
Measured speed	n_R	–	689	–	rpm	46	P_7.4.11.47
Measured speed	n_R	–	692	–	rpm	47	P_7.4.11.48
Measured speed	n_R	–	696	–	rpm	48	P_7.4.11.49
Measured speed	n_R	–	699	–	rpm	49	P_7.4.11.50
Measured speed	n_R	–	702	–	rpm	50	P_7.4.11.51
Measured speed	n_R	–	706	–	rpm	51	P_7.4.11.52
Measured speed	n_R	–	709	–	rpm	52	P_7.4.11.53
Measured speed	n_R	–	713	–	rpm	53	P_7.4.11.54
Measured speed	n_R	–	716	–	rpm	54	P_7.4.11.55
Measured speed	n_R	–	720	–	rpm	55	P_7.4.11.56
Measured speed	n_R	–	724	–	rpm	56	P_7.4.11.57
Measured speed	n_R	–	727	–	rpm	57	P_7.4.11.58
Measured speed	n_R	–	731	–	rpm	58	P_7.4.11.59
Measured speed	n_R	–	735	–	rpm	59	P_7.4.11.60
Measured speed	n_R	–	738	–	rpm	60	P_7.4.11.61
Measured speed	n_R	–	742	–	rpm	61	P_7.4.11.62
Measured speed	n_R	–	746	–	rpm	62	P_7.4.11.63
Measured speed	n_R	–	750	–	rpm	63	P_7.4.11.64

LIN interface

Table 82 Parameter “measured speed” (cont’d) for **NVM-RMS_report = 0_B¹⁾**

Parameter	Symbol	Values			Unit	Note or Test Condition	Number
		Min.	Typ.	Max.			
Measured speed	n_R	–	754	–	rpm	64	P_7.4.11.65
Measured speed	n_R	–	758	–	rpm	65	P_7.4.11.66
Measured speed	n_R	–	762	–	rpm	66	P_7.4.11.67
Measured speed	n_R	–	766	–	rpm	67	P_7.4.11.68
Measured speed	n_R	–	770	–	rpm	68	P_7.4.11.69
Measured speed	n_R	–	774	–	rpm	69	P_7.4.11.70
Measured speed	n_R	–	778	–	rpm	70	P_7.4.11.71
Measured speed	n_R	–	783	–	rpm	71	P_7.4.11.72
Measured speed	n_R	–	787	–	rpm	72	P_7.4.11.73
Measured speed	n_R	–	791	–	rpm	73	P_7.4.11.74
Measured speed	n_R	–	796	–	rpm	74	P_7.4.11.75
Measured speed	n_R	–	800	–	rpm	75	P_7.4.11.76
Measured speed	n_R	–	804	–	rpm	76	P_7.4.11.77
Measured speed	n_R	–	809	–	rpm	77	P_7.4.11.78
Measured speed	n_R	–	814	–	rpm	78	P_7.4.11.79
Measured speed	n_R	–	818	–	rpm	79	P_7.4.11.80
Measured speed	n_R	–	823	–	rpm	80	P_7.4.11.81
Measured speed	n_R	–	828	–	rpm	81	P_7.4.11.82
Measured speed	n_R	–	832	–	rpm	82	P_7.4.11.83
Measured speed	n_R	–	837	–	rpm	83	P_7.4.11.84
Measured speed	n_R	–	842	–	rpm	84	P_7.4.11.85
Measured speed	n_R	–	847	–	rpm	85	P_7.4.11.86
Measured speed	n_R	–	852	–	rpm	86	P_7.4.11.87
Measured speed	n_R	–	857	–	rpm	87	P_7.4.11.88
Measured speed	n_R	–	862	–	rpm	88	P_7.4.11.89
Measured speed	n_R	–	867	–	rpm	89	P_7.4.11.90
Measured speed	n_R	–	873	–	rpm	90	P_7.4.11.91
Measured speed	n_R	–	878	–	rpm	91	P_7.4.11.92
Measured speed	n_R	–	883	–	rpm	92	P_7.4.11.93
Measured speed	n_R	–	889	–	rpm	93	P_7.4.11.94
Measured speed	n_R	–	894	–	rpm	94	P_7.4.11.95
Measured speed	n_R	–	900	–	rpm	95	P_7.4.11.96
Measured speed	n_R	–	906	–	rpm	96	P_7.4.11.97
Measured speed	n_R	–	911	–	rpm	97	P_7.4.11.98
Measured speed	n_R	–	917	–	rpm	98	P_7.4.11.99
Measured speed	n_R	–	923	–	rpm	99	P_7.4.11.100
Measured speed	n_R	–	929	–	rpm	100	P_7.4.11.101

LIN interface

Table 82 Parameter “measured speed” (cont’d) for **NVM-RMS_report = 0_B¹⁾**

Parameter	Symbol	Values			Unit	Note or Test Condition	Number
		Min.	Typ.	Max.			
Measured speed	n_R	–	935	–	rpm	101	P_7.4.11.102
Measured speed	n_R	–	941	–	rpm	102	P_7.4.11.103
Measured speed	n_R	–	947	–	rpm	103	P_7.4.11.104
Measured speed	n_R	–	954	–	rpm	104	P_7.4.11.105
Measured speed	n_R	–	960	–	rpm	105	P_7.4.11.106
Measured speed	n_R	–	966	–	rpm	106	P_7.4.11.107
Measured speed	n_R	–	973	–	rpm	107	P_7.4.11.108
Measured speed	n_R	–	980	–	rpm	108	P_7.4.11.109
Measured speed	n_R	–	986	–	rpm	109	P_7.4.11.110
Measured speed	n_R	–	993	–	rpm	110	P_7.4.11.111
Measured speed	n_R	–	1000	–	rpm	111	P_7.4.11.112
Measured speed	n_R	–	1007	–	rpm	112	P_7.4.11.113
Measured speed	n_R	–	1014	–	rpm	113	P_7.4.11.114
Measured speed	n_R	–	1021	–	rpm	114	P_7.4.11.115
Measured speed	n_R	–	1029	–	rpm	115	P_7.4.11.116
Measured speed	n_R	–	1036	–	rpm	116	P_7.4.11.117
Measured speed	n_R	–	1043	–	rpm	117	P_7.4.11.118
Measured speed	n_R	–	1051	–	rpm	118	P_7.4.11.119
Measured speed	n_R	–	1059	–	rpm	119	P_7.4.11.120
Measured speed	n_R	–	1067	–	rpm	120	P_7.4.11.121
Measured speed	n_R	–	1075	–	rpm	121	P_7.4.11.122
Measured speed	n_R	–	1083	–	rpm	122	P_7.4.11.123
Measured speed	n_R	–	1091	–	rpm	123	P_7.4.11.124
Measured speed	n_R	–	1099	–	rpm	124	P_7.4.11.125
Measured speed	n_R	–	1106	–	rpm	125	P_7.4.11.126
Measured speed	n_R	–	1116	–	rpm	126	P_7.4.11.127
Measured speed	n_R	–	1125	–	rpm	127	P_7.4.11.128
Measured speed	n_R	–	1134	–	rpm	128	P_7.4.11.129
Measured speed	n_R	–	1143	–	rpm	129	P_7.4.11.130
Measured speed	n_R	–	1152	–	rpm	130	P_7.4.11.131
Measured speed	n_R	–	1161	–	rpm	131	P_7.4.11.132
Measured speed	n_R	–	1171	–	rpm	132	P_7.4.11.133
Measured speed	n_R	–	1180	–	rpm	133	P_7.4.11.134
Measured speed	n_R	–	1190	–	rpm	134	P_7.4.11.135
Measured speed	n_R	–	1200	–	rpm	135	P_7.4.11.136
Measured speed	n_R	–	1210	–	rpm	136	P_7.4.11.137
Measured speed	n_R	–	1220	–	rpm	137	P_7.4.11.138

LIN interface

Table 82 Parameter “measured speed” (cont’d) for **NVM-RMS_report = 0_B¹⁾**

Parameter	Symbol	Values			Unit	Note or Test Condition	Number
		Min.	Typ.	Max.			
Measured speed	n_R	–	1231	–	rpm	138	P_7.4.11.139
Measured speed	n_R	–	1241	–	rpm	139	P_7.4.11.140
Measured speed	n_R	–	1252	–	rpm	140	P_7.4.11.141
Measured speed	n_R	–	1263	–	rpm	141	P_7.4.11.142
Measured speed	n_R	–	1274	–	rpm	142	P_7.4.11.143
Measured speed	n_R	–	1286	–	rpm	143	P_7.4.11.144
Measured speed	n_R	–	1297	–	rpm	144	P_7.4.11.145
Measured speed	n_R	–	1309	–	rpm	145	P_7.4.11.146
Measured speed	n_R	–	1321	–	rpm	146	P_7.4.11.147
Measured speed	n_R	–	1333	–	rpm	147	P_7.4.11.148
Measured speed	n_R	–	1346	–	rpm	148	P_7.4.11.149
Measured speed	n_R	–	1358	–	rpm	149	P_7.4.11.150
Measured speed	n_R	–	1371	–	rpm	150	P_7.4.11.151
Measured speed	n_R	–	1385	–	rpm	151	P_7.4.11.152
Measured speed	n_R	–	1398	–	rpm	152	P_7.4.11.153
Measured speed	n_R	–	1412	–	rpm	153	P_7.4.11.154
Measured speed	n_R	–	1426	–	rpm	154	P_7.4.11.155
Measured speed	n_R	–	1440	–	rpm	155	P_7.4.11.156
Measured speed	n_R	–	1455	–	rpm	156	P_7.4.11.157
Measured speed	n_R	–	1469	–	rpm	157	P_7.4.11.158
Measured speed	n_R	–	1485	–	rpm	158	P_7.4.11.159
Measured speed	n_R	–	1500	–	rpm	159	P_7.4.11.160
Measured speed	n_R	–	1516	–	rpm	160	P_7.4.11.161
Measured speed	n_R	–	1532	–	rpm	161	P_7.4.11.162
Measured speed	n_R	–	1548	–	rpm	162	P_7.4.11.163
Measured speed	n_R	–	1565	–	rpm	163	P_7.4.11.164
Measured speed	n_R	–	1582	–	rpm	164	P_7.4.11.165
Measured speed	n_R	–	1600	–	rpm	165	P_7.4.11.166
Measured speed	n_R	–	1618	–	rpm	166	P_7.4.11.167
Measured speed	n_R	–	1636	–	rpm	167	P_7.4.11.168
Measured speed	n_R	–	1655	–	rpm	168	P_7.4.11.169
Measured speed	n_R	–	1674	–	rpm	169	P_7.4.11.170
Measured speed	n_R	–	1694	–	rpm	170	P_7.4.11.171
Measured speed	n_R	–	1714	–	rpm	171	P_7.4.11.172
Measured speed	n_R	–	1735	–	rpm	172	P_7.4.11.173
Measured speed	n_R	–	1756	–	rpm	173	P_7.4.11.174
Measured speed	n_R	–	1778	–	rpm	174	P_7.4.11.175

LIN interface

Table 82 Parameter “measured speed” (cont’d) for **NVM-RMS_report = 0_B¹⁾**

Parameter	Symbol	Values			Unit	Note or Test Condition	Number
		Min.	Typ.	Max.			
Measured speed	n_R	–	1800	–	rpm	175	P_7.4.11.176
Measured speed	n_R	–	1823	–	rpm	176	P_7.4.11.177
Measured speed	n_R	–	1846	–	rpm	177	P_7.4.11.178
Measured speed	n_R	–	1870	–	rpm	178	P_7.4.11.179
Measured speed	n_R	–	1895	–	rpm	179	P_7.4.11.180
Measured speed	n_R	–	1920	–	rpm	180	P_7.4.11.181
Measured speed	n_R	–	1946	–	rpm	181	P_7.4.11.182
Measured speed	n_R	–	1973	–	rpm	182	P_7.4.11.183
Measured speed	n_R	–	2000	–	rpm	183	P_7.4.11.184
Measured speed	n_R	–	2028	–	rpm	184	P_7.4.11.185
Measured speed	n_R	–	2057	–	rpm	185	P_7.4.11.186
Measured speed	n_R	–	2087	–	rpm	186	P_7.4.11.187
Measured speed	n_R	–	2118	–	rpm	187	P_7.4.11.188
Measured speed	n_R	–	2149	–	rpm	188	P_7.4.11.189
Measured speed	n_R	–	2182	–	rpm	189	P_7.4.11.190
Measured speed	n_R	–	2215	–	rpm	190	P_7.4.11.191
Measured speed	n_R	–	2250	–	rpm	191	P_7.4.11.192
Measured speed	n_R	–	2286	–	rpm	192	P_7.4.11.193
Measured speed	n_R	–	2323	–	rpm	193	P_7.4.11.194
Measured speed	n_R	–	2361	–	rpm	194	P_7.4.11.195
Measured speed	n_R	–	2400	–	rpm	195	P_7.4.11.196
Measured speed	n_R	–	2441	–	rpm	196	P_7.4.11.197
Measured speed	n_R	–	2483	–	rpm	197	P_7.4.11.198
Measured speed	n_R	–	2526	–	rpm	198	P_7.4.11.199
Measured speed	n_R	–	2571	–	rpm	199	P_7.4.11.200
Measured speed	n_R	–	2618	–	rpm	200	P_7.4.11.201
Measured speed	n_R	–	2667	–	rpm	201	P_7.4.11.202
Measured speed	n_R	–	2717	–	rpm	202	P_7.4.11.203
Measured speed	n_R	–	2769	–	rpm	203	P_7.4.11.204
Measured speed	n_R	–	2824	–	rpm	204	P_7.4.11.205
Measured speed	n_R	–	2880	–	rpm	205	P_7.4.11.206
Measured speed	n_R	–	2939	–	rpm	206	P_7.4.11.207
Measured speed	n_R	–	3000	–	rpm	207	P_7.4.11.208
Measured speed	n_R	–	3064	–	rpm	208	P_7.4.11.209
Measured speed	n_R	–	3130	–	rpm	209	P_7.4.11.210
Measured speed	n_R	–	3200	–	rpm	210	P_7.4.11.211
Measured speed	n_R	–	3273	–	rpm	211	P_7.4.11.212

LIN interface

Table 82 Parameter “measured speed” (cont'd) for **NVM-RMS_report = 0_B¹⁾**

Parameter	Symbol	Values			Unit	Note or Test Condition	Number
		Min.	Typ.	Max.			
Measured speed	n_R	–	3349	–	rpm	212	P_7.4.11.213
Measured speed	n_R	–	3429	–	rpm	213	P_7.4.11.214
Measured speed	n_R	–	3512	–	rpm	214	P_7.4.11.215
Measured speed	n_R	–	3600	–	rpm	215	P_7.4.11.216
Measured speed	n_R	–	3692	–	rpm	216	P_7.4.11.217
Measured speed	n_R	–	3789	–	rpm	217	P_7.4.11.218
Measured speed	n_R	–	3892	–	rpm	218	P_7.4.11.219
Measured speed	n_R	–	4000	–	rpm	219	P_7.4.11.220
Measured speed	n_R	–	4114	–	rpm	220	P_7.4.11.221
Measured speed	n_R	–	4235	–	rpm	221	P_7.4.11.222
Measured speed	n_R	–	4364	–	rpm	222	P_7.4.11.223
Measured speed	n_R	–	4500	–	rpm	223	P_7.4.11.224
Measured speed	n_R	–	4645	–	rpm	224	P_7.4.11.225
Measured speed	n_R	–	4800	–	rpm	225	P_7.4.11.226
Measured speed	n_R	–	4966	–	rpm	226	P_7.4.11.227
Measured speed	n_R	–	5143	–	rpm	227	P_7.4.11.228
Measured speed	n_R	–	5333	–	rpm	228	P_7.4.11.229
Measured speed	n_R	–	5538	–	rpm	229	P_7.4.11.230
Measured speed	n_R	–	5760	–	rpm	230	P_7.4.11.231
Measured speed	n_R	–	6000	–	rpm	231	P_7.4.11.232
Measured speed	n_R	–	6261	–	rpm	232	P_7.4.11.233
Measured speed	n_R	–	6545	–	rpm	233	P_7.4.11.234
Measured speed	n_R	–	6857	–	rpm	234	P_7.4.11.235
Measured speed	n_R	–	7200	–	rpm	235	P_7.4.11.236
Measured speed	n_R	–	7579	–	rpm	236	P_7.4.11.237
Measured speed	n_R	–	8000	–	rpm	237	P_7.4.11.238
Measured speed	n_R	–	8471	–	rpm	238	P_7.4.11.239
Measured speed	n_R	–	9000	–	rpm	239	P_7.4.11.240
Measured speed	n_R	–	9600	–	rpm	240	P_7.4.11.241
Measured speed	n_R	–	10266	–	rpm	241	P_7.4.11.242
Measured speed	n_R	–	11077	–	rpm	242	P_7.4.11.243
Measured speed	n_R	–	12000	–	rpm	243	P_7.4.11.244
Measured speed	n_R	–	13091	–	rpm	244	P_7.4.11.245
Measured speed	n_R	–	14400	–	rpm	245	P_7.4.11.246
Measured speed	n_R	–	16000	–	rpm	246	P_7.4.11.247
Measured speed	n_R	–	18000	–	rpm	247	P_7.4.11.248
Measured speed	n_R	–	20571	–	rpm	248	P_7.4.11.249

LIN interface

Table 82 Parameter “measured speed” (cont’d) for **NVM-RMS_report = 0_B**¹⁾

Parameter	Symbol	Values			Unit	Note or Test Condition	Number
		Min.	Typ.	Max.			
Measured speed	n_R	–	–	–	rpm	249	P_7.4.11.250
Measured speed	n_R	–	–	–	rpm	250	P_7.4.11.251
Measured speed	n_R	–	–	–	rpm	251	P_7.4.11.252
Measured speed	n_R	–	–	–	rpm	252	P_7.4.11.253
Measured speed	n_R	–	–	–	rpm	253	P_7.4.11.254
Measured speed	n_R	–	–	–	rpm	254	P_7.4.11.255
Measured speed	n_R	–	–	–	rpm	255	P_7.4.11.256

1) Speed values represent the threshold for switching to the coding shown in the table. The shown values do not include the speed measurement tolerance.

Table 83 Parameter “measured speed” for **NVM-RMS_report = 1_B**

Parameter	Symbol	Values			Unit	Note or Test Condition	Number
		Min.	Typ.	Max.			
Register “Measured speed”	RMS	6	–	255	–	–	P_7.4.12.1
Measured speed	n_R ¹⁾	–	RMS*100	–	rpm	6≤RMS≤255	P_7.4.12.3

1) The shown values for the measured speed do not include the speed measurement tolerance.

6.4.13 Register RSUPP and RCLASS

The readable internal register RSUPP[2:0] contains the alternator supplier code. The ECU can monitor this register by using the LIN data field TH.

The readable internal register RCLASS[4:0] contains the alternator class code. The ECU can monitor this register by using the LIN data field TI.

The registers RSUPP and RCLASS are loaded from the EEPROM.

6.5 Default register content

The registers shown in table **Table 84** are writable registers. Therefore, these registers will be set by the device if:

- a logic reset occurs, or
- the TLE8881-2 wakes up from stand-by, or
- the state machine enters the state “default operation”.

LIN interface

Table 84 Default writable register content

TLE8881-2 register	Description	Reference
RVSET[7:0]	Dependent on NVM-VSET . Without NVM modification (default values): VSET = 14.3 V VDA-A/OEM2: RVSET[7:2] := 100010 _B (= 34) VDA-B/OEM1: RVSET[7:0] := 10001000 _B (= 136)	Register RVSET (voltage setpoint), Section 6.4.1
RLRCBZ	Dependent on NVM-LRCBZ and NVM-LRCBZ_0_SEL . Without NVM modification (default values): LRCBZ = 3 % RLRCBZ := 0 _B	Registers LRC (load response control), Section 6.4.3
RLRCRT[3:0]	Dependent on NVM-LRCRT and NVM-LRCRT_1s . Without NVM modification (default values): LRCRT = 5 s VDA-A: RLRCRT[3:0] := 0011 _B (= 3) VDA-B/OEM1/OEM2: RLRCRT[3:0] := 0110 _B (= 6)	Registers LRC (load response control), Section 6.4.3
RLRCDIS[3:0]	Dependent on NVM-LRCDIS . Without NVM modification: $n_{LRCDIS} = 4000$ rpm RLRCDIS[3:0] := 1000 _B	Registers LRC (load response control), Section 6.4.3
RCLIM[7:0]	Excitation current limitation disabled: RCLIM[7:0] := 00000000 _B (= 0)	Register RCLIM (excitation current limitation), Section 6.4.4
RDI[2:0]	Request data indicator RDI[2:0] := 000 _B	Register RDI (response data indicator), Section 6.4.7
RHT[2:0]	THT = 160°C RHT[2:0] := 000 _B (0°C temperature delta to THT)	Register RHT (adjustment of high temperature threshold), Section 6.4.6
RFPARA	RFPARA = 0 _B	Register RFPARA (F-Para function), Section 6.4.5

The registers shown in **Table 85** are readable registers. These register will be initialized if:

- a logic reset occurs, or
- the TLE8881-2 wakes up from stand-by state.

Table 85 Default readable register content

TLE8881-2 register	Description	Reference
RDC[4:0]	Excitation PWM duty cycle DC = 0% RDC[4:0] := 00000 _B	Register RDC (excitation PWM duty cycle), Section 6.4.8
RMC6[5:0]	Measured excitation current MC = 0 A RMC6[5:0] := 000000 _B (= 0)	Register RMC (measured excitation current), Section 6.4.9
RMC8[7:0]	Measured excitation current MC = 0 A RMC8[7:0] := 00000000 _B (= 0)	Register RMC (measured excitation current), Section 6.4.9
RMV[7:0]	Measured voltage MV = 8 V RMV[7:0] := 00000000 _B (= 0)	Register RMV (measured voltage at VBA terminal), Section 6.4.11

LIN interface

Table 85 Default readable register content (cont'd)

TLE8881-2 register	Description	Reference
RMT[7:0]	VDA-A/VDA-B/OEM1: Measured temperature MT = 24...28°C RMT[7:0] := 00010010 _B (= 18) OEM2: Measured temperature MT = 31°C RMT[7:0] := 01001001 _B (= 73)	Register RMT (measured temperature on chip), Section 6.4.10
RMS[7:0]	RMS[7:0] := 00000000 _B (< 560 rpm)	Register RMS (measured speed), Section 6.4.12
RCLASS[4:0]	Without NVM modification: 11111 _B (= 31)	Register RSUPP and RCLASS, Section 6.4.13
RSUPP[2:0]	Without NVM modification: 0000001 _B (= 1)	Register RSUPP and RCLASS, Section 6.4.13
Diagnosis flags	F-HT := 0 F-EL := 0 F-ROT := 0 F-CEF := 0 F-CTO depends on state machine (refer to Chapter 4.4)	-

6.6 Register output filters

The TLE8881-2 includes Exponentially Weighted Moving Average (EWMA) filters of the first-order with its cut-off frequency f_{FLT} at $\tau = 63\%$. These filters are used for the output of some internal registers which are communicated via LIN TX frames. The filtered values are not applied to the excitation output stage and excitation DMOS.

6.6.1 Filter for excitation PWM duty cycle (RDC filter)

The excitation PWM duty cycle calculated by the TLE8881-2 during the regulation activity is readable via LIN at the register RDC of the TX1 and TX3 commands after the EWMA filtering (see [Chapter 6.4.8](#)). The filtered value is not applied to the excitation output stage.

The activation of the filter and its characteristics are configurable via [NVM-DC_EWMA_K](#) and depend on [NVM-CFG](#).

If the PSB (Phase Signal Boost) function is active, leading to switching between 100% (on-time) and 0% (off-time) of the excitation PWM duty cycle, the input of the filter is regulated by the [NVM-DC_EWMA_MODE](#).

PSB is an internal function to maintain the phase signal and is not relevant for computation models inside ECU. The duty cycle which is communicated via LIN TX frames is used as input for most computation models.

With the [NVM-DC_EWMA_MODE](#) parameter, a different input value during an activated PSB function can be selected to blank out this internal maintenance.

With the [DC_EWMA_mode_DC0](#) parameter, the input value of the filter during activated PSB function can be forced to zero. This parameter has priority over any setting in [NVM-DC_EWMA_MODE](#).

LIN interface

Table 86 Parameter for “RDC filter” if **NVM-CFG = 10_B**

All parameters are valid for: $-40^{\circ}\text{C} < T_J < 150^{\circ}\text{C}$; $V_{BA} = 14.5\text{ V}$ unless otherwise specified:

Parameter	Symbol	Values			Unit	Note or Test Condition	Number
		Min.	Typ.	Max.			
RDC filter deactivated	f_{DCF}	–	–	–	Hz	¹⁾ ; NVM-DC_EWMA_K = 00_B	P_7.6.1.5
RDC filter time	f_{DCF}	0.5	1	1.5	Hz	¹⁾ ; NVM-DC_EWMA_K = 01_B	P_7.6.1.1
RDC filter time	f_{DCF}	3	5	7	Hz	¹⁾ ; NVM-DC_EWMA_K = 10_B	P_7.6.1.2
RDC filter time	f_{DCF}	7	10	13	Hz	¹⁾ ; NVM-DC_EWMA_K = 11_B	P_7.6.1.3

1) Not subject to production test

Table 87 Parameter for “RDC filter” if **NVM-CFG ≠ 10_B**

All parameters are valid for: $-40^{\circ}\text{C} < T_J < 150^{\circ}\text{C}$; $V_{BA} = 14.5\text{ V}$ unless otherwise specified:

Parameter	Symbol	Values			Unit	Note or Test Condition	Number
		Min.	Typ.	Max.			
Duty cycle filter time	t_{DCF}	-15%	NVM-DC_EWMA_K	+15%	ms	¹⁾	P_7.6.1.4

1) Not subject to production test

6.6.2 Filter for voltage measurement (RMV Filter)

The measured voltage at the VBA pin is readable via LIN at the register RMV after the EWMA filtering (see [Chapter 6.4.11](#)).

The activation of the filter and its characteristics are configurable via the NVM field **NVM-MV_EWMA_K**.

Table 88 Parameter for “RMV filter”

All parameters are valid for: $-40^{\circ}\text{C} < T_J < 150^{\circ}\text{C}$; unless otherwise specified:

Parameter	Symbol	Values			Unit	Note or Test Condition	Number
		Min.	Typ.	Max.			
RMV filter deactivated	f_{MVF}	–	–	–	Hz	¹⁾ ; NVM-MV_EWMA_K = 00_B	P_7.6.2.4
RMV filter time	f_{MVF}	0.5	1	1.5	Hz	¹⁾ ; NVM-MV_EWMA_K = 01_B	P_7.6.2.1
RMV filter time	f_{MVF}	3	5	7	Hz	¹⁾ ; NVM-MV_EWMA_K = 10_B	P_7.6.2.2
RMV filter time	f_{MVF}	7	10	13	Hz	¹⁾ ; NVM-MV_EWMA_K = 11_B	P_7.6.2.3

1) Not subject to production test

LIN interface

6.6.3 Excitation current filter (RMC filter)

The measured current is readable via LIN at the register RMC after the EWMA filtering (see [Chapter 6.4.9](#)). The activation of the excitation current filter and its characteristics are configurable via the NVM field [NVM-MC_EWMA_K](#).

Table 89 Parameter for “RMC filter”

All parameters are valid for: $-40^{\circ}\text{C} < T_J < 150^{\circ}\text{C}$; $V_{BA} = 14.5\text{ V}$ unless otherwise specified:

Parameter	Symbol	Values			Unit	Note or Test Condition	Number
		Min.	Typ.	Max.			
RMC filter deactivated	f_{MCF}	–	–	–	Hz	¹⁾ ; NVM-MC_EWMA_K = 00_B	P_7.6.3.1
RMC filter time	f_{MCF}	0.5	1	1.5	Hz	¹⁾ ; NVM-MC_EWMA_K = 01_B	P_7.6.3.1
RMC filter time	f_{MCF}	3	5	7	Hz	¹⁾ ; NVM-MC_EWMA_K = 10_B	P_7.6.3.2
RMC filter time	f_{MCF}	7	10	13	Hz	¹⁾ ; NVM-MC_EWMA_K = 11_B	P_7.6.3.3

1) Not subject to production test

LIN interface

6.7 LIN 2.1 diagnostic frames

Diagnostic frames are part of the LIN 2.1 data link layer specification only.

The TLE8881-2 is defined as a Class-1 device in the LIN 2.1 network.

By design, the TLE8881-2 supports two dedicated LIN 2.1 services:

- Assign frame ID range ([Chapter 6.7.3](#))
- Read by identifier ([Chapter 6.7.4](#))

6.7.1 Node configuration / identification

If the frame identifier $3C_H$ or $3D_H$ is identified, the upcoming frames are going to carry configuration and identification data. It has to be distinguished between the Master Request Frame (MRF) and the Slave Response Frame (SRF), whereas the respective frame are notified by:

- Master Request Frame (MRF): $3C_H$
- Slave Response Frame (SRF): $3D_H$

The requests are executed by the slave device as soon as the MRF is received and found to be valid (i.e. no bit errors, checksum ok, etc).

MRF and SRF may be interleaved with an unconditional frame, e.g. MRF → RX → SRF.

As defined in the LIN specification MRF with NAD = 00_H (where the following data is neglected) is interpreted as a go-to-sleep command, regardless of the frame's data bytes.

6.7.2 NAD, supplier ID, function ID and variant

In order to enable the LIN 2.1 services, the device's node address (NAD) and at least the wildcard values of the function ID and the supplier ID should be known. The NAD is used in the MRF and SRF frames to address one particular slave node in a cluster, or to indicate the source of a response. The supplier ID is assigned to one supplier by the LIN Consortium. Distinguishing between the different application functions of distinct devices can be handled by the function ID. The wildcard values are defined in the LIN 2.1 Protocol Specification. The specific values for the TLE8881-2 are given in [Table 90](#).

Table 90 Overview of LIN2.1 diagnostic frames identification codings

Message Type	Identification	Wildcard / broadcast NAD
Supplier ID	0066_H	$7FFF_H$ (Wildcard)
Function ID	7007_H	$FFFF_H$ (Wildcard)
Variant	00_H	-
Alternator 1 NAD (if NVM-ALT = 0_B)	46_H	$7F_H$ (Broadcast NAD)
Alternator 2 NAD (if NVM-ALT = 1_B)	47_H	$7F_H$ (Broadcast NAD)

All values are hard-wired. The NAD is implemented as a metal option (8 bit) and can be changed via **NVM-ALT**. Wildcards (= broadcasts) are fully supported by the TLE8881-2.

Beside these fixed supplier ID, function ID and variant, the TLE8881-2 offers the alternator's supplier ID (3 bits), the alternator class ID (5 bits), the ASIC Manufacturer ID (001_B for Infineon) and the ASIC ID (5 bits) in the TX2 frame, as given in [Chapter 6.4.13](#).

It has to be considered that the LIN master is responsible for collision-avoidance (e.g. requests for SRF after broadcast MRF).

LIN interface

Broadcast NAD

Broadcast NAD will be used to send one MRF Frame to multiple LIN slaves in parallel. A LIN frame containing a broadcast NAD is sent to all LIN 2.1 slave nodes in the LIN network. In case of multiple responses (e.g. collisions on the bus), the LIN slave will detect a bit-error, abort the transmission and set the F-CEF flag.

NAD = 00_H is used for go-to-sleep.

Support for diagnostic NAD (7E_H)

Diagnostic NAD is only used for functional addressing for the transport layer. The TLE8881-2 is defined as a Class-1 device. Class-1 devices do not need to support the transport layer diagnostics.

Therefore, the TLE8881-2 does not support this feature.

6.7.3 Assign frame ID range (LIN 2.1 service)

This supported service allows the LIN master to reconfigure the frame identifiers (also called PID in LIN 2.1 specification) of the slave. In order to ensure a proper behavior after start-up, the PIDs are set to their default values. By sending the correct assign-frame-ID-range command, a LIN master could change the PIDs to new values. Attention has to be paid to the fact that the TLE8881-2 will not check the newly assigned PIDs for correctness. This function is implemented to be LIN 2.1 compliant.

As the OEM might not want to use the assign frame ID function, it can be deactivated in EEPROM via **NVM-AFIDen**.

An assign-frame-ID-range command comprises of a kind of header, containing the NAD of the addressed device, the protocol control information (PCI) and a service identifier (SID). These three bytes follow after the actual LIN header containing synch-break, synch-byte and PID. The respective bytes are given in **Table 91**.

Table 91 Assign frame ID range service codings

	Byte name	Byte content
Master Request Frame (MRF)	PCI	06 _H
	SID	B7 _H
Slave Response Frame (SRF)	PCI	01 _H
	RSID	F7 _H

The NAD, PCI and SID are then followed by 5 data bytes. The first byte indicates the starting index (e.g. first PID to modify), and the following 4 bytes indicate the new PID values. Refer to **Figure 20** for an overview picture. Valid values for PIDs are FF_H for “don't care”, i.e. do not modify this frame's PID, 00_H for “unset” which trigger the frame inactive, and any valid PID value between 00_H and 3B_H. For the TLE8881-2, the command could change the PIDs of the frames RX, TX1, TX2 and TX3 (in the respective order regarding the incrementing index). The MRF and SRF (frames 3C_H and 3D_H) are hard-wired, thus their PIDs cannot be changed. The request (if correct) is processed immediately after the reception of the Master Request Frame (MRF) is complete.



Figure 20 Assign-frame-ID-range MRF layout (NAD = 46_H/47_H, PCI = 06_H, SID = B7_H)

After processing an assign-frame-ID-range command, the TLE8881-2 responds to a consecutive SRF only if the command is processed correctly. There is no error-response to this service.

LIN interface

If the command was processed by the device, it sends the following response upon receiving an SRF (refer to [Figure 21](#)).

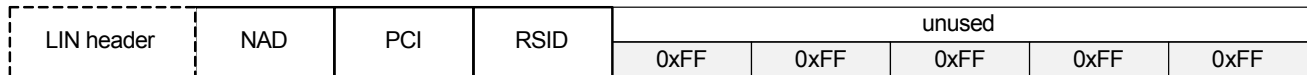

Figure 21 Assign-frame-ID-range SRF layout (NAD = 46_H/47_H, PCI = 01_H, RSID = F7_H)

6.7.4 Read by identifier (LIN 2.1 service)

This service is used by a master to obtain specific information about a LIN slave device. Since the TLE8881-2 is configured as a Class-1 device, it only supports a query of function ID, supplier ID and variant.

Just like the assign-frame-ID-range service, the command for this service consists of a kind of header containing the slave’s NAD, a PCI and a SID.

The respective bytes are given in [Table 92](#).

Table 92 Read by identifier service codings

	Byte name	Byte content
Master Request Frame (MRF)	PCI	06 _H
	SID	B2 _H
Slave Response Frame (SRF)	PCI	06 _H
	RSID	F2 _H

Afterwards follows an Identifier which defines the query. The TLE8881-2 only supports identifier=0 followed by 4 data bytes containing the supplier ID and function ID (either the actual values or wildcards). Refer to [Figure 22](#) for an overview picture. If the values for the supplier and/or function ID do not match the LIN slave’s IDs, the TLE8881-2 will not send a response. If the slave’s IDs are not known to the master, the usage of wildcard values for function and supplier IDs is possible for those fields.

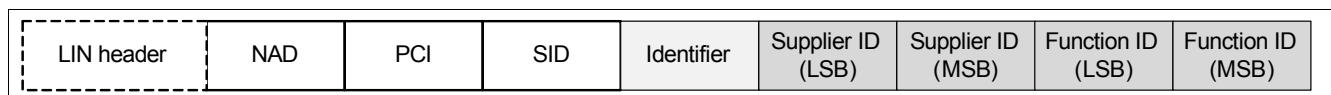

Figure 22 Read by identifier MRF layout (NAD = 46_H/47_H, PCI = 06_H, SID = B2_H)

The response consists of a header followed by the supplier ID, function ID and the variant (last byte). This response layout is shown in [Figure 23](#).

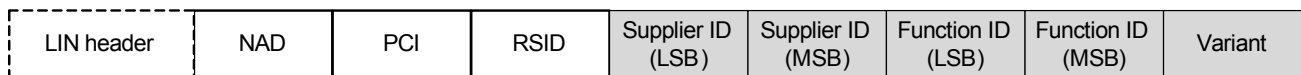

Figure 23 Read by identifier SRF layout (NAD = 46_H/47_H, PCI = 06_H, SID = F2_H)

6.8 Programming Mode

For details regarding programming the device please contact your sales representative or the Technical Assistance Center (TAC).

LIN interface

6.9 Internal LIN timers

A set of internal timers is implemented in the core to support several functions for the LIN communication (refer to [Table 93](#)).

All timings are directly dependant on the internal oscillator ([Chapter 8.3](#)).

Table 93 Parameters for internal LIN timers

All parameters are valid for: $-40^{\circ}\text{C} < T_J < 150^{\circ}\text{C}$; $V_{BA} = 14.5\text{ V}$ unless otherwise specified:

Parameter	Symbol	Values			Unit	Note or Test Condition	Number
		Min.	Typ.	Max.			
Delay time to reset diagnosis flag F-EL	$t_{F-EL,Reset}$	20	62.5	100	ms	1)	P_7.9.0.1
Test mode entry timer	$t_{TMSTART}$	130	145	160	ms	1); After wake-up or logic reset	P_7.9.0.8
Test mode deactivation timer	t_{TMOFF}	9.1	10.3	11.5	s	1); After wake-up or logic reset	P_7.9.0.9

1) Not subject to production test.

Table 94 Modified timers in test mode

Timer	Parameter name	Acceleration factor
t_{CTO}	No valid LIN communication timer	256
t_{F-EL}	Diagnosis flag debounce timer	32

Phase monitoring block

7 Phase monitoring block

7.1 Block diagram

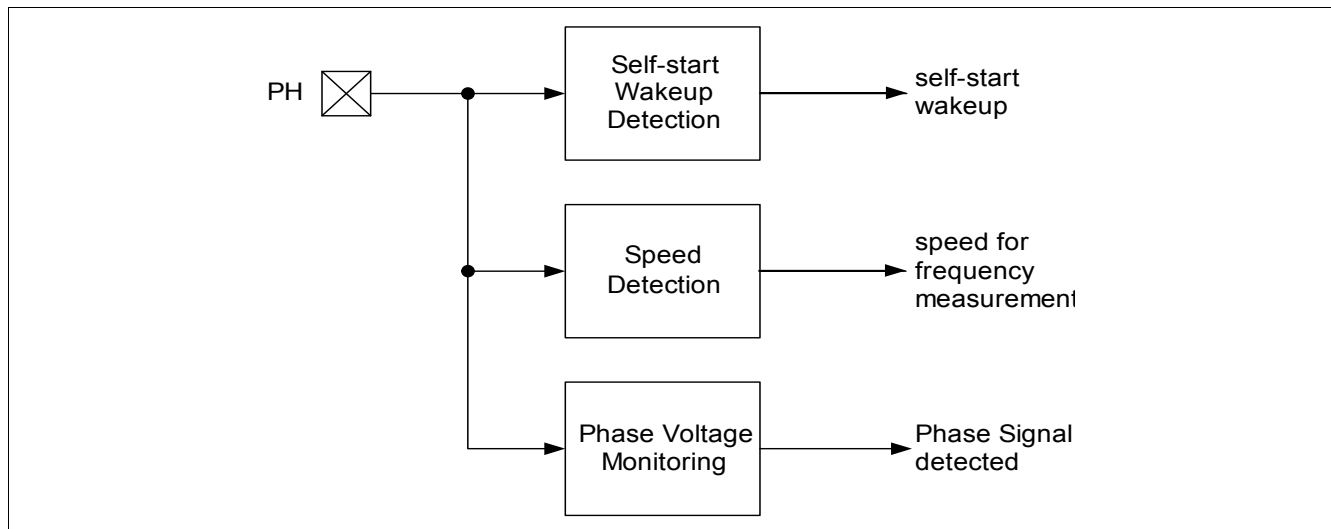

Figure 24 Phase monitoring block

7.2 Self-start wake-up

Table 95 Parameter “self-start wake-up

All parameters are valid for: $-40^{\circ}\text{C} < T_J < 150^{\circ}\text{C}$; $V_{\text{BA}} = 14.5\text{ V}$ unless otherwise specified:

Parameter	Symbol	Values			Unit	Note or Test Condition	Number
		Min.	Typ.	Max.			
Self-start wake-up voltage threshold	V_{DET}	100	200	350	mVpp	$V_{\text{PH,CM}} = 1\text{ V}$; $f_{\text{PH}} = 600\text{ Hz}$; $T_J = 27^{\circ}\text{C}$; Phase voltage (peak-to-peak) for self-start wake-up in state “stand-by”	P_8.2.0.1

Phase monitoring block

7.3 Speed detection

Table 96 Parameter “speed detection”

All parameters are valid for: $-40^{\circ}\text{C} < T_J < 150^{\circ}\text{C}$; $V_{BA} = 14.5\text{ V}$ unless otherwise specified:

Parameter	Symbol	Values			Unit	Note or Test Condition	Number
		Min.	Typ.	Max.			
Peak-to-peak speed detection threshold	V_{DET}	–	200	–	mVpp	Phase voltage (peak-to-peak) for speed detection in states “ComActive” and “default operation”	P_8.3.0.1
Peak-to-peak speed detection threshold	V_{DET}	–	800	–	mVpp	Phase voltage (peak-to-peak) for speed detection in state “pre-excitation” and CTO = 0 (no LIN communication time-out)	P_8.3.0.2
Peak-to-peak speed detection threshold	V_{DET}	–	800	–	mVpp	Phase voltage (peak-to-peak) for speed detection in state “normal operation”.	P_8.3.0.3

7.4 Phase monitoring

The phase voltage monitoring block monitors the voltage at the phase input PH. The voltage is used for the phase signal boost function ([Chapter 5.11](#)) and for the engine stop detection.

Table 97 Parameter phase monitoring

All parameters are valid for: $-40^{\circ}\text{C} < T_J < 150^{\circ}\text{C}$; $V_{BA} = 14.5\text{ V}$ unless otherwise specified:

Parameter	Symbol	Values			Unit	Note or Test Condition	Number
		Min.	Typ.	Max.			
Pull down resistor at terminal PH	R_{PHRD}	20	33	50	k Ω	In state “pre-excitation”	P_8.4.0.1
Pull down resistor at terminal PH	R_{PHRD}	60	100	165	k Ω	All states except “pre-excitation”	P_8.4.0.2
Phase Signal time-out	$t_{PH,TO}$	15	60	120	ms	1),2), ;	P_8.4.0.3

- 1) Not subject to production test.
- 2) In case of phase signal loss, an event is generated after a time-out $t_{PH,TO}$. This event is used by the state machine to ensure that in case of no valid LIN communication and too low rotor speed, the TLE8881-2 goes to stand-by mode.

Core functions

8 Core functions

8.1 Voltage reference

A band gap reference is used for internal comparisons to achieve calibrated results.

8.2 Internal supply reference

The TLE8881-2 is equipped with the following voltage sources:

- internal 5 V supply for analogue circuitry
- internal 3.3 V supply for the CMOS logic circuitry

8.3 Oscillator

The oscillator generates the clock signal required by the logic functions (main control, regulation block, TLE8881-2 registers and LIN protocol handler).

Table 98 Parameter oscillator

All parameters are valid for: $-40^{\circ}\text{C} < T_J < 150^{\circ}\text{C}$; $V_{\text{BA}} = 14.5\text{ V}$ unless otherwise specified:

Parameter	Symbol	Values			Unit	Note or Test Condition	Number
		Min.	Typ.	Max.			
Oscillator frequency	f_{OSC}	1.62	1.8	1.98	MHz	Value is trimmed at 25°C	P_9.3.0.1

8.4 Charge pump

The charge pump is required for the excitation high-side driver. The charge pump does not require any external energy storage capacitor.

Core functions

8.5 Restore state function

During the operation of the TLE8881-2, a supply micro-cut can occur. The restore state function as implemented restores the operation state as well as essential register values to avoid a perceptible disruption in operation.

8.5.1 Supply micro-cut

Table 99 Parameter micro-cut

All parameters are valid for: $-40^{\circ}\text{C} < T_J < 150^{\circ}\text{C}$; $V_{BA} = 14.5\text{ V}$ unless otherwise specified:

Parameter	Symbol	Values			Unit	Note or Test Condition	Number
		Min.	Typ.	Max.			
Supply micro-cut repetition period	T_{MC1}	10	–	–	ms	¹⁾ ; $V_{BA} > 0\text{ V}$	P_9.5.1.1
Supply micro-cut duration	T_{MC2}	–	–	100	μs	¹⁾ ; $V_{BA} > 0\text{ V}$	P_9.5.1.2
Supply micro-cut fall time	T_{MC3}	5	–	50	μs	¹⁾ ; $V_{BA} > 0\text{ V}$	P_9.5.1.3
Supply micro-cut rise time	T_{MC4}	5	–	50	μs	¹⁾ ; $V_{BA} > 0\text{ V}$	P_9.5.1.4

1) Not subject to production test.

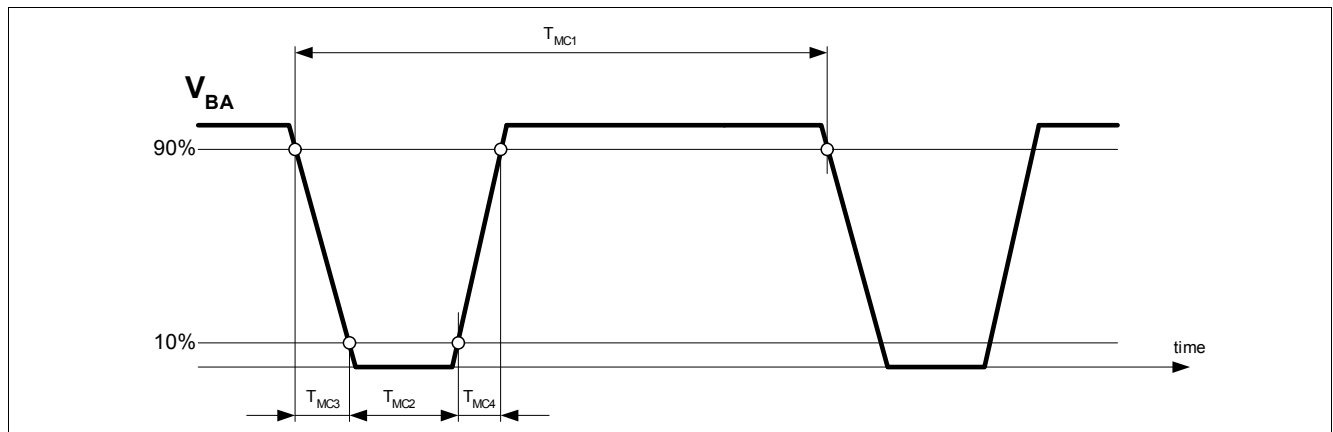

Figure 25 Supply micro-cut

Core functions

8.5.2 Restore state event

If a logic inadvertent reset occurs in the state normal operation or default operation, the following information is stored for at least ($T_{MC2}+T_{MC3}+T_{MC4}$) and restored after reset:

- Normal operation data bit (fast startup in normal operation or default operation)
- Regulation voltage setpoint (VSET) with a resolution of 100 mV
- LRC rise time (LRCRT)
- Targeted FEXLIM region
- F-Para function activation (as requested via the LIN RX frame)

After the reset the following actions are executed if a valid restore state condition is detected:

- The stored register information is restored, all other registers are initialized (like after wake-up).
- The LRC duty cycle is set to 100%.
- Dependent on the stored information, the state machine continues either on the state “normal operation” or “default operation”.

The restore state function does not store information related to the assign frame ID range service (refer to [Chapter 6.7.3](#)). This means that any previously assigned LIN IDs have to be re-assigned after inadvertent reset.

Non-Volatile Memory (NVM)

9 Non-Volatile Memory (NVM)

Throughout this chapter the terms NVM (Non-Volatile Memory) and EEPROM are used as synonyms, disregarding the fact that NVM describes a broader class of memories, where the described EEPROM is only a special case.

With the available NVM field-set, the TLE8881-2 offers the tuning, activation and deactivation of specific functions so that a wide range of applications are addressable with one single device properly configured.

After every regular power-up, on stand-by wake-up, or after internal logic reset, the NVM content is transferred into the internal registers within $t_{\text{power-up}}$ (see [P_3.2.0.11](#)).

9.1 NVM characteristics

The required characteristics to program and verify the NVM are given in [Table 9-1](#).

Table 9-1 Parameter NVM

All parameters are valid for: $-40\text{ °C} < T_J < 150\text{ °C}$; $V_{BA} = 14.5\text{ V}$ unless otherwise specified:

Parameter	Symbol	Values			Unit	Note or Test Condition	Number
		Min.	Typ.	Max.			
Maximum Number of program and erase cycles	N_{PECyc}	100	–	–	–	1)	P_10.1.0.1
Temperature range for program and erase	T_{PE}	0	25	80	°C	1)	P_10.1.0.2
Voltage level at VBA during program and erase	V_{BAPE}	32	–	40	V	–	P_10.1.0.3
Set voltage for “under-voltage condition” during program and erase	V_{BAfailPE}	27	–	32	V	–	P_10.1.0.4

1) Not subject to production test.

Attention: Programming and verification requires at least 32 V supply at V_{BA} (refer to [Table 9-1](#)).

Non-Volatile Memory (NVM)

9.2 NVM register description

The register descriptions of the NVM - which can be accessed via the programming mode - are presented and described in this chapter.

9.2.1 List overview

Table 9-2 to **Table 9-5** show a listed overview of all accessible NVM fields.

Non-Volatile Memory (NVM)

Table 9-2 List overview of accessible NVM fields (sorted by placement in the EEPROM)

Address	Section	Field	Short name
00 _H	0	NVM-LINRX	LIN RX frame ID
00 _H	0	NVM-ALT	Alternator number in vehicle LIN network
00 _H	0	NVM-LIN	LIN version
00 _H	1	NVM-LINTX1	LIN TX1 frame ID
00 _H	1	NVM-RPARA_SEL	Selection of parameter set for F-PARA
00 _H	2	NVM-CFG	OEM configuration
01 _H	0	NVM-LINTX2	LIN TX2 frame ID
01 _H	0	NVM-LRCBZ_0_SEL	LRC blind zone “0” selection

Table 9-3 List overview of accessible NVM fields (NVM-LIN=0_B)

Address	Section	Field	Short name
01 _H	1	NVM-LINTX3	LINTX3 frame ID
01 _H	1	NVM-LEOLRC	LRC after LEO function
01 _H	1	NVM-AFIDen	“Assign frame ID” service disable

Table 9-4 List overview of accessible NVM fields (NVM-LIN=1_B)

Address	Section	Field	Short name
01 _H	1	NVM-LINTX3	LINTX3 frame ID
01 _H	1	NVM-LEOLRC	LRC after LEO function
01 _H	1	NVM-3Ddis	Enable/disable 3D frame for LIN1.3

Table 9-5 List overview of accessible NVM fields (sorted by placement in the EEPROM)

Address	Section	Field	Short name
01 _H	2	NVM-EOFF	Activation of excitation-off state
02 _H	0	NVM-SUPP	Alternator supplier
02 _H	0	NVM-CLASS	Alternator class
02 _H	1	NVM-DC_EWMA_MODE	Excitation duty cycle filter mode during Phase Signal Boost (PSB)
02 _H	1	NVM-DC_EWMA_K	Excitation duty cycle filter coefficients
02 _H	1	NVM-RMS_report	RMS reporting
02 _H	1	NVM-MC_EWMA_K	Excitation current filter coefficients
02 _H	1	NVM-MV_EWMA_K	Measurement voltage filter coefficients
02 _H	2	NVM-PP	Alternator pole pairs
03 _H	0	NVM-HEO_ANDis	Disable analogue HEO function
03 _H	0	NVM-LRCRT	LRC rise-time for default operation
03 _H	0	NVM-LEOTIMERdis	LEO (Low-Voltage Excitation On) function disable switch
03 _H	1	NVM-VSET_report	Type of VSET reporting selection

Non-Volatile Memory (NVM)

Table 9-5 List overview of accessible NVM fields (sorted by placement in the EEPROM) (cont'd)

Address	Section	Field	Short name
03 _H	1	NVM-PREEXC_27HZ5_DIS	Pre-excitation duty cycle selection
03 _H	1	NVM-PEXCDC	Duty cycle in pre-excitation state
03 _H	1	NVM-LRCBZ	Selection of the LRC blind zone in default operation state
03 _H	2	NVM-SSS	Self-start speed threshold
04 _H	0	NVM-LEO	Default VLOW for LEO function (Low Voltage Excitation ON)
04 _H	0	NVM-LEO_ERR_EN	LEO/F-EL interaction setting
04 _H	0	NVM-T_EL_ERR	Debounce time of electrical error flag (F-EL)
04 _H	0	NVM-HEO_ERR_EN	Overvoltage error flag switch
04 _H	0	NVM-FROT_SEL	Configuration for the mechanical error flag F-ROT
04 _H	1	NVM-THT	Absolute threshold for high-temperature voltage compensation
04 _H	1	NVM-HTG	Gradient for high-temperature voltage compensation
04 _H	1	NVM-CLIM	Excitation overcurrent protection threshold
04 _H	2	NVM-T_PSB_ON_MAX	Maximum ON-time for PSB (Phase Signal Boost) function
05 _H	0	NVM-FEXLIM_PCLIM1	Frequency dependent current limitation (FEXLIM) feature: PCLIM1 region
05 _H	0	NVM-FEXLIM_EN	Enable/disable frequency dependent current limitation (FEXLIM) function
05 _H	0	NVM-FEXLIM_PCLIM2	Frequency dependent current limitation (FEXLIM) feature: PCLIM2 region
05 _H	1	Reserved	Reserved
05 _H	2	Reserved	Reserved
06 _H	0	NVM-LRCRT_1s	Enable 1s option for the default LRC rise time
06 _H	0	NVM-VSET	Voltage set-point for default operation
06 _H	0	DC_EWMA_mode_DC0	Excitation duty cycle filter mode during Phase Signal Boost (PSB)
06 _H	1	NVM-CSHT	Disable curve shaping at high temperature
06 _H	1	NVM-LRCFT	LRC fall-time
06 _H	1	NVM-IEXC100	Minimum excitation current at 100% DC to avoid open load detection
06 _H	2	Reserved	Reserved
07 _H	0	NVM-Speed_TH	Speed-dependent KiKp parameter sets (KiKp function) Speed threshold - upper value of hysteresis
07 _H	0	NVM-LRCDIS	Rotor speed to disable LRC for default operation
07 _H	1	NVM-VoKiKp	Voltage dependent KiKp function (VoKiKp function) configuration Enabling and VoKiKp up threshold
07 _H	1	NVM-VoKiKp_low_HEO_speed	Voltage dependent KiKp function (VoKiKp) speed dependency
07 _H	1	NVM-KiKp	KiKp function configuration

Non-Volatile Memory (NVM)

Table 9-5 List overview of accessible NVM fields (sorted by placement in the EEPROM) (cont'd)

Address	Section	Field	Short name
07 _H	1	NVM-LOW_HEO	Speed-dependent lowering of the HEO limit (LowHEO function) Enabling and LowHEO voltage selection
07 _H	2	NVM-LOCK_EN	Enable NVM Lock

Non-Volatile Memory (NVM)

9.2.2 Detailed description

NVM_A00_S0

Address 00_H - Section 0

(00_H)Reset Value: 00_H

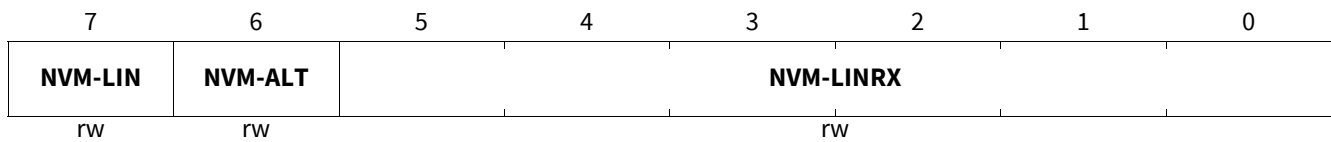

Field	Bits	Type	Description
NVM-LINRX	5:0	rw	LIN RX frame ID Default LIN RX frame ID (refer to Chapter 6.3.2).
NVM-ALT	6	rw	Alternator number in vehicle LIN network Defines the alternator number in the vehicle LIN network. This switch is independent from configuration of the LIN IDs, but relates to the LIN 2.1 NAD (refer to Chapter 6.7.2). 0 _B Device is configured to be regulator #1 in implemented LIN network (NAD=46H), 1 _B Device is configured to be regulator #2 in implemented LIN network (NAD=47H),
NVM-LIN	7	rw	LIN version Selection of the compliance for the LIN communication standard specification. This selection includes the usage of the classic or enhanced checksum and the related protocol features. (refer to Chapter 6.3.1) 0 _B LIN 2.1, 1 _B LIN 1.3,

Non-Volatile Memory (NVM)

NVM_A00_S1

Address 00_H - Section 1

(00_H)Reset Value: 00_H

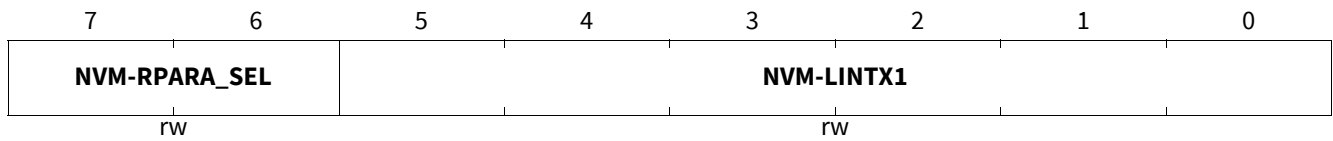

Field	Bits	Type	Description
NVM-LINTX1	5:0	rw	LIN TX1 frame ID Defines the LIN Identifier bits for the LIN TX1 frame. The relating parity bits are calculated internally (refer to Chapter 6.3.2).
NVM-RPARA_SEL	7:6	rw	Selection of parameter set for F-PARA The F-Para function can be activated by sending respective code “1” in LIN RX frame. If the F-Para function is active, a parameter set with changed regulation dynamic is used (refer to Chapter 5.14). 00 _B Slowest dynamic, 01 _B Slower dynamic, 10 _B Slow dynamic, 11 _B Normal dynamic,

NVM_A00_S2

Address 00_H - Section 2

(00_H)Reset Value: 00_H

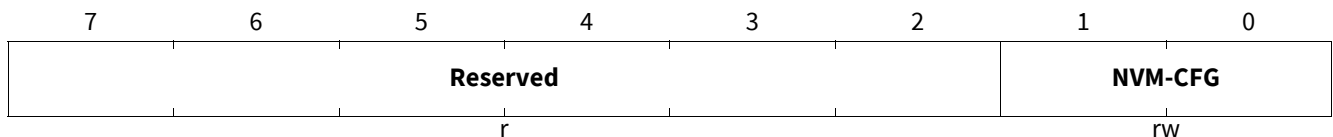

Field	Bits	Type	Description
NVM-CFG	1:0	rw	OEM configuration Dedicated LIN frame layouts for the LIN RX/TX3/TX4 frame and internal registers (e.g. default rise-time for the LRC function) can be adjusted by using this switch (refer to Chapter 6.3.1). 00 _B VDA-A, 01 _B VDA-B, 10 _B OEM1, 11 _B OEM2,
Reserved	7:2	r	Reserved Reserved read-only area.

Non-Volatile Memory (NVM)

NVM_A01_S0

Address 01_H - Section 0

(00_H)Reset Value: 00_H

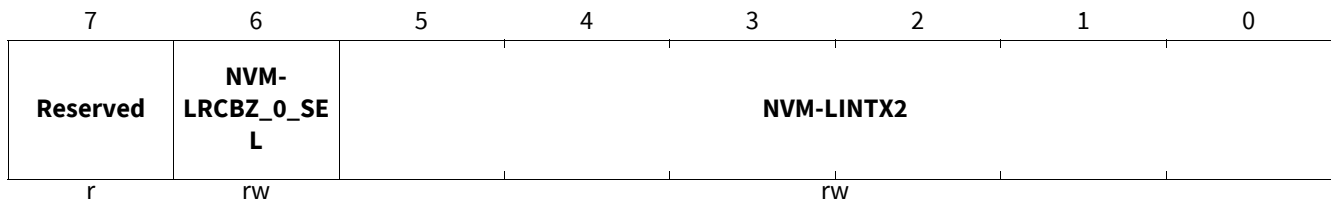

Field	Bits	Type	Description
NVM-LINTX2	5:0	rw	LIN TX2 frame ID Defines the LIN Identifier bits for the LIN TX2 frame. The relating parity bits are calculated internally (refer to Chapter 6.3.2).
NVM-LRCBZ_0_SEL	6	rw	LRC blind zone “0” selection The blind zone of the LRC function can be adjusted via the LIN RX frame. Depending on this NVM field, setting the blind zone code to “0” inside the LIN RX frame (RF=0 _B in LIN RX frame) invokes respective blind zone values (refer to Chapter 5.12). 0 _B 3% , Code “0” of the blind zone command invokes 3% blind zone usage for the LRC function. 1 _B 6.25% , Code “0” of the blind zone command invokes 6.25% blind zone usage for the LRC function.
Reserved	7	r	Reserved Reserved read-only area

NVM_A01_S1 for NVM-LIN = 0B

Address 01_H - Section 1

(00_H)Reset Value: 00_H

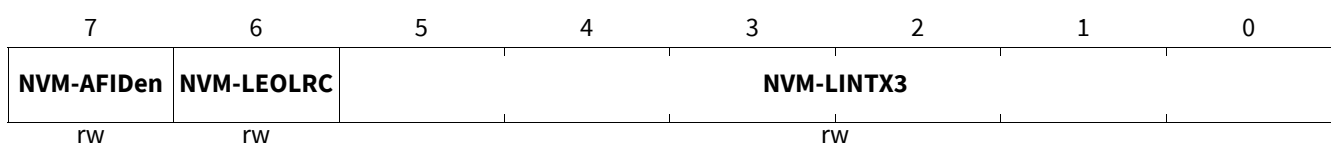

Field	Bits	Type	Description
NVM-LINTX3	5:0	rw	LINTX3 frame ID Defines the LIN Identifier bits for the LIN TX3 frame. The relating parity bits are calculated internally (refer to Chapter 6.3.2).
NVM-LEOLRC	6	rw	LRC after LEO function Defines the behavior of the LRC function when returning to regulation after a LEO activation (refer to Chapter 5.12). 0 _B 100% DC after LEO till Vset is reached, 1 _B Enable LRC after LEO,

Non-Volatile Memory (NVM)

Field	Bits	Type	Description
NVM-AFIDen	7	rw	<p>“Assign frame ID” service disable “Assign frame ID” service is a dedicated LIN 2.1 service to re-assign identifier for a LIN frame (refer to Chapter 6.7.3).</p> <p><i>Note: It is not recommended to use this service inside the real application, since micro-cuts of the voltage supply would lead to complete reset of the device including the reassign frame identifier.</i></p> <p>0_B Assign frame ID disabled, for LIN 2.1 (recommended for higher robustness) 1_B Assign frame ID enabled, for LIN 2.1</p>

NVM_A01_S1 for NVM-LIN = 1B

Address 01_H - Section 1

(00_H)Reset Value: 00_H

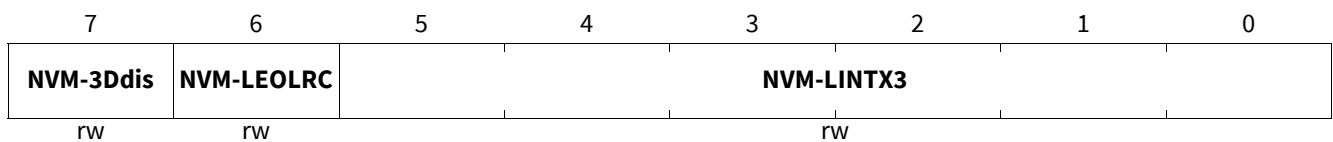

Field	Bits	Type	Description
NVM-LINTX3	5:0	rw	<p>LINTX3 frame ID Defines the LIN Identifier bits for the LIN TX3 frame. The relating parity bits are calculated internally (refer to Chapter 6.3.2).</p>
NVM-LEOLRC	6	rw	<p>LRC after LEO function Defines the behavior of the LRC function when returning to regulation after a LEO activation (refer to Chapter 5.12).</p> <p>0_B 100% DC after LEO till Vset is reached, 1_B Enable LRC after LEO,</p>
NVM-3Ddis	7	rw	<p>Enable/disable 3D frame for LIN1.3 “3D disable” service is a dedicated LIN 1.3 service and used to enable/disable the 3D special LIN frame (refer to Chapter 6.3.2).</p> <p>0_B 3D frame enabled, for LIN 1.3 1_B 3D frame disabled, for LIN 1.3</p>

NVM_A01_S2

Address 01_H - Section 2

(00_H)Reset Value: 00_H

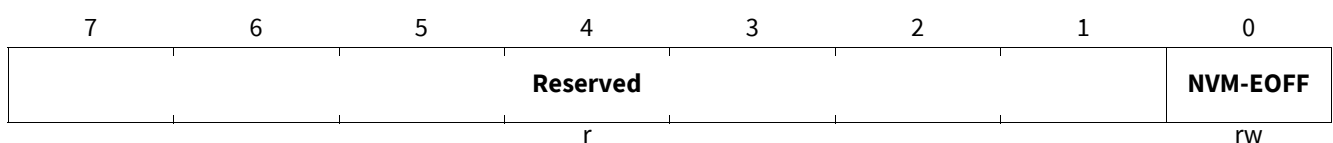

Non-Volatile Memory (NVM)

Field	Bits	Type	Description
NVM-EOFF	0	rw	<p>Activation of excitation-off state State machine can trigger the excitation-off state (EXC output stage is switched off, DC=0%), if the command VSET=10.6 V is sent via LIN while normal operation state is active. If this trigger activation is disabled, the chip regulates to 10.6 V instead of changing to excitation-off state. (refer to Chapter 4.4.6)</p> <p>0_B Deactivate, excitation-off state deactivated and VSET=10.6 V does not trigger state change from normal operation to excitation-off.</p> <p>1_B Activate, excitation-off state activated and enabled, if command VSET=10.6 V is sent via LIN.</p>
Reserved	7:1	r	<p>Reserved Reserved read-only area</p>

NVM_A02_S0
 Address 02_H - Section 0 (00_H) Reset Value: 00_H

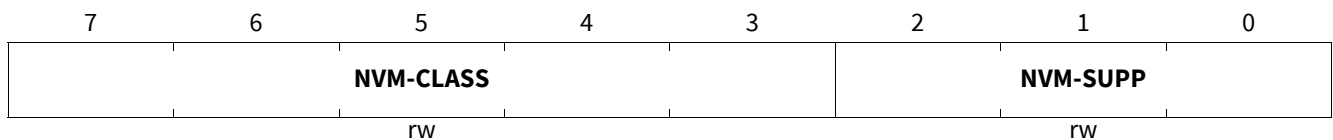

Field	Bits	Type	Description
NVM-SUPP	2:0	rw	<p>Alternator supplier Free-configurable 3-bit value to set alternator supplier</p>
NVM-CLASS	7:3	rw	<p>Alternator class Free-configurable 5-bit value to set alternator class</p>

NVM_A02_S1
 Address 02_H - Section 1 (00_H) Reset Value: 00_H

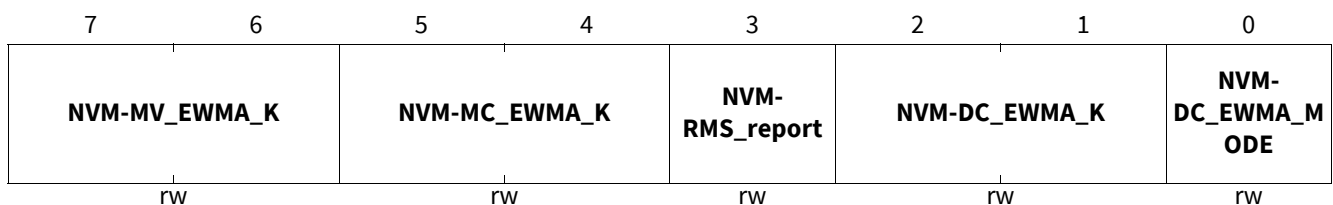

Non-Volatile Memory (NVM)

Field	Bits	Type	Description
NVM-DC_EWMA_MODE	0	rw	<p>Excitation duty cycle filter mode during Phase Signal Boost (PSB) PSB is an internal function to maintain the phase signal and is not relevant for computation models inside ECU. DC is used as model input for most computations models, which is communicated via LIN TX frames. If the phase signal falls below the PSB threshold (e.g. due to voltage set-point below battery voltage level), the PSB function is activated until phase signal has been backed up again. The EWMA mode can be used to blank out this internal maintenance by using a different input value during an activated PSB function (refer to Chapter 6.6.1).</p> <p>The option Input := 0 can be selected by DC_EWMA_mode_DC0.</p> <p>0_B Filter Input := DC from regulation, the EWMA filter will be fed with DC from calculations coming out of the PI regulation (e.g. 0% DC, if $V_{SET} < V_{BA}$).</p> <p>1_B Filter Input := DC from pre-excitation, the EWMA filter will be fed with a fixed DC as controlled by NVM-PEXCDC.</p>
NVM-DC_EWMA_K	2:1	rw	<p>Excitation duty cycle filter coefficients Enable/disable and cut-off frequency of the EWMA filter of the PWM duty cycle (refer to Chapter 6.6.1).</p> <p>00_B None, (EWMA filter disabled) 01_B 1 Hz, if NVM-CFG is "OEM1" 10_B 5 Hz, if NVM-CFG is "OEM1" 11_B 10 Hz, if NVM-CFG is "OEM1" 00_B 35 ms, if NVM-CFG is not "OEM1" 01_B 70 ms, if NVM-CFG is not "OEM1" 10_B 140 ms, if NVM-CFG is not "OEM1" 11_B 210 ms, if NVM-CFG is not "OEM1"</p>
NVM-RMS_report	3	rw	<p>RMS reporting Selection of the RMS reporting style (refer to Chapter 6.4.12).</p> <p>0_B Classic reporting style, 1_B Linear RMS reporting,</p>
NVM-MC_EWMA_K	5:4	rw	<p>Excitation current filter coefficients Enable/disable and cut-off frequency of the EWMA filter of the excitation current (refer to Chapter 6.6.3).</p> <p>00_B None, (EWMA filter disabled) 01_B 1 Hz, 10_B 5 Hz, 11_B 10 Hz,</p>
NVM-MV_EWMA_K	7:6	rw	<p>Measurement voltage filter coefficients Enable/disable and cut-off frequency of the EWMA filter of the measured voltage (refer to Chapter 6.6.2).</p> <p>00_B None, (EWMA filter disabled) 01_B 1 Hz, 10_B 5 Hz, 11_B 10 Hz,</p>

Non-Volatile Memory (NVM)

NVM_A02_S2

Address 02_H - Section 2

(00_H)Reset Value: 00_H

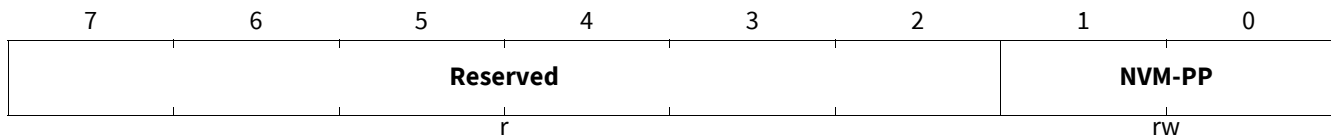

Field	Bits	Type	Description
NVM-PP	1:0	rw	Alternator pole pairs Number of pole pairs of the alternator, required to calculate the speed of the alternator pulley (refer to Chapter 4.2). 00 _B 5 pole pairs, 01 _B 6 pole pairs, 10 _B 7 pole pairs, 11 _B 8 pole pairs,
Reserved	7:2	r	Reserved Reserved read-only area

NVM_A03_S0

Address 03_H - Section 0

(00_H)Reset Value: 00_H

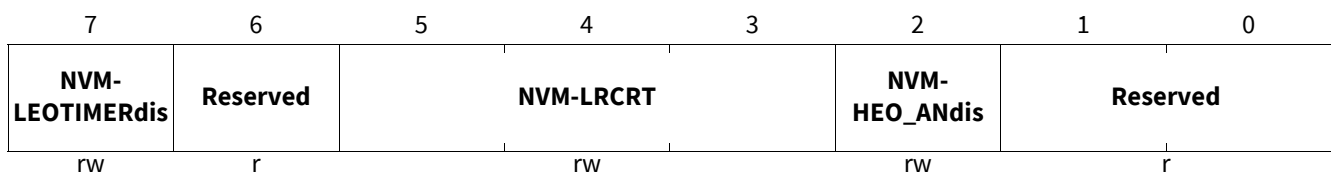

Field	Bits	Type	Description
Reserved	1:0	r	Reserved Reserved read-only area
NVM-HEO_ANdis	2	rw	Disable analogue HEO function (refer to Chapter 5.10) 0 _B Enabled, 1 _B Disabled,
NVM-LRCRT	5:3	rw	LRC rise-time for default operation If the LIN communication is absent for longer than 3 seconds, the state machine switches to default operation and uses the default LRC rise-time setting (refer to Chapter 6.5). The option 1 s can be selected by NVM-LRCRT_1s . 000 _B Disabled, 001 _B 2 s, 010 _B 3 s, 011 _B 4 s, 100 _B 5 s, 101 _B 6 s, 110 _B 7 s, 111 _B 8 s,

Non-Volatile Memory (NVM)

Field	Bits	Type	Description
Reserved	6	r	Reserved Reserved read-only area
NVM-LEOTIMERdis	7	rw	LEO (Low-Voltage Excitation On) function disable switch To avoid charging a defective battery, a LEO start-up timer checks the battery voltage and deactivates the LEO function in case of a constantly low VBA (refer to Chapter 5.9). 0 _B LEO start-up timer enabled, 1 _B LEO start-up timer disabled,

NVM_A03_S1

Address 03_H - Section 1

(00_H)Reset Value: 00_H

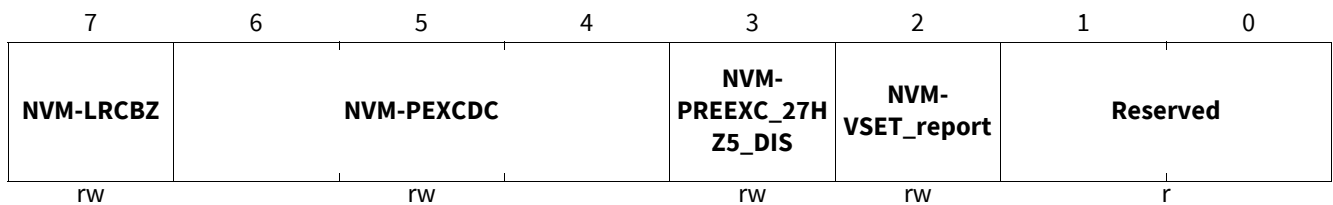

Field	Bits	Type	Description
Reserved	1:0	r	Reserved Reserved read-only area
NVM-VSET_report	2	rw	Type of VSET reporting selection (refer to Chapter 6.4.2) 0 _B RX_LIN-VSET is reported, 1 _B Applied VSET is reported,
NVM-PREXC_27HZ5_DIS	3	rw	Pre-excitation duty cycle selection While in pre-excitation state, a fixed duty cycle at the excitation output stage is driven as adjusted in the NVM field NVM-PEXCDC . The carrying frequency can be adjusted by using this switch (refer to Chapter 5.1). 0 _B 27 Hz, Pre-excitation duty cycle 1 _B 220 Hz, Pre-excitation duty cycle
NVM-PEXCDC	6:4	rw	Duty cycle in pre-excitation state Applied fixed duty cycle (RDC) while in pre-excitation state. The fixed output frequency can be adjusted by the NVM field NVM-PREXC_27HZ5_DIS (refer to Chapter 4.4.4). 000 _B 5%, 001 _B 7.5%, 010 _B 10%, 011 _B 12.5%, 100 _B 15%, 101 _B 17.5%, 110 _B 20%, 111 _B 25%,

Non-Volatile Memory (NVM)

Field	Bits	Type	Description
NVM-LRCBZ	7	rw	Selection of the LRC blind zone in default operation state Selection of the desired LRC blind zone while in default operation state (refer to Chapter 5.12). 0 _B 3% / 6.25%, depending on NVM field NVM-LRCBZ_0_SEL 1 _B 12%,

NVM_A03_S2

Address 03_H - Section 2

(00_H)Reset Value: 00_H

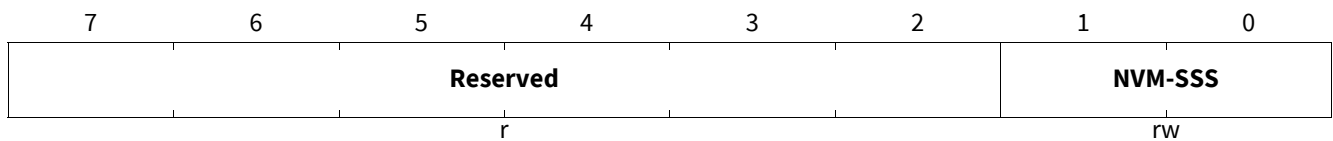

Field	Bits	Type	Description
NVM-SSS	1:0	rw	Self-start speed threshold In case of absent LIN communication, an emergency start function assures proper operation of the regulator, if the TLE8881-2 is still in standby mode (no alternator rotation). The detection threshold of this emergency start function can be adjusted with this NVM field (physical parameter: nCUT2) (refer to Chapter 4.2). 00 _B 2000 rpm, 01 _B 3000 rpm, 10 _B 4000 rpm, 11 _B 5000 rpm,
Reserved	7:2	r	Reserved Reserved read-only area

NVM_A04_S0

Address 04_H - Section 0

(00_H)Reset Value: 00_H

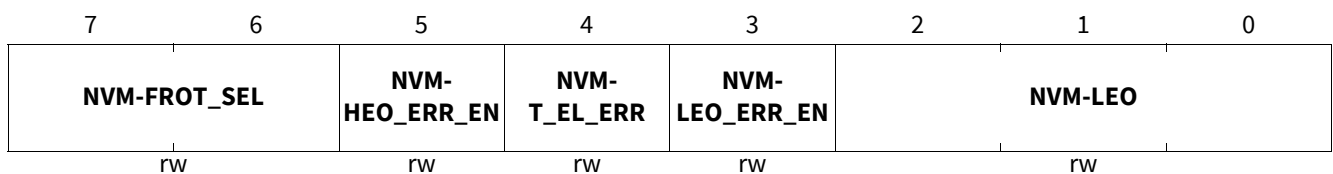

Non-Volatile Memory (NVM)

Field	Bits	Type	Description
NVM-LEO	2:0	rw	Default V_{LOW} for LEO function (Low Voltage Excitation ON) (refer to Chapter 5.9) 000 _B 8.75 V , 001 _B 9.0 V , 010 _B 9.25 V , 011 _B 9.5 V , 100 _B 9.75 V , 101 _B 10.0 V , 110 _B 10.25 V , 111 _B 10.5 V ,
NVM-LEO_ERR_EN	3	rw	LEO/F-EL interaction setting Enable/disable interaction of LEO and the electrical error flag F-EL (refer to Chapter 4.5.3). 0 _B Deactivate , LEO cannot set to the F-EL flag. 1 _B Activate , LEO can set to the F-EL flag.
NVM-T_EL_ERR	4	rw	Debounce time of electrical error flag (F-EL) Sets the debounce time for the electrical error flag (refer to Chapter 4.5.3). 0 _B 250 ms , 1 _B 1000 ms ,
NVM-HEO_ERR_EN	5	rw	Overvoltage error flag switch (refer to Chapter 4.5.3) 0 _B Deactivate , HEO does not set F-EL flag. 1 _B Activate , HEO sets the error flag F-EL, if active.
NVM-FROT_SEL	7:6	rw	Configuration for the mechanical error flag F-ROT (refer to Chapter 4.5.2) 00 _B F-ROT set in pre-excitation , 01 _B F-ROT set in ComActive, pre-excitation and EXC-OFF , 10 _B Reserved , 11 _B Reserved ,

NVM_A04_S1

Address 04_H - Section 1

(00_H)Reset Value: 00_H

7	6	5	4	3	2	1	0
NVM-CLIM		NVM-HTG			NVM-THT		
rw		rw			r		

Non-Volatile Memory (NVM)

Field	Bits	Type	Description
NVM-THT	2:0	r	<p>Absolute threshold for high-temperature voltage compensation This absolute threshold can be fine-tuned with relative adjustments by LIN RX frame commands. This threshold marks the point to start the high-temperature voltage compensation relatively to the 16 V setpoint. For VSET < 16 V, the voltage setpoint will be compensated by matching the compensation gradient (NVM field NVM-HTG) (refer to Chapter 5.6).</p> <p>000_B 125°C, 001_B 130°C, 010_B 135°C, 011_B 140°C, 100_B 145°C, 101_B 150°C, 110_B 155°C, 111_B 160°C,</p>
NVM-HTG	5:3	rw	<p>Gradient for high-temperature voltage compensation As soon as the high-temperature threshold has been exceeded, relatively to the 16 V setpoint a negative compensation gradient is applied to the actual voltage setpoint (refer to Chapter 5.6).</p> <p>000_B -50 mV/K, 001_B -100 mV/K, 010_B -150 mV/K, 011_B -200 mV/K, 100_B -250 mV/K, 101_B -300 mV/K, 110_B -350 mV/K, 111_B -400 mV/K,</p>
NVM-CLIM	7:6	rw	<p>Excitation overcurrent protection threshold Current threshold for the activation of the overcurrent limitation feature (refer to Chapter 5.2).</p> <p>00_B 9 A, 01_B 10 A, 10_B 11 A, 11_B 12 A,</p>

NVM_A04_S2

Address 04_H - Section 2

(00_H)Reset Value: 00_H

7	6	5	4	3	2	1	0
Reserved						NVM-T_PSB_ON_MAX	
r						rw	

Non-Volatile Memory (NVM)

Field	Bits	Type	Description
NVM-T_PSB_ON_MAX	1:0	rw	Maximum ON-time for PSB (Phase Signal Boost) function Relating to Chapter 5.11 , the phase signal boost function has a fixed OFF-time and an adjustable ON-time (DC = 100%). The PSB function helps to recover a low phase signal to assure a proper measurement of the phase signal. 00 _B 155 ms , 01 _B 100 ms , 10 _B 45 ms , 11 _B 27 ms ,
Reserved	7:2	r	Reserved Reserved read-only area

NVM_A05_S0
 Address 05_H - Section 0 (00_H) Reset Value: 00_H

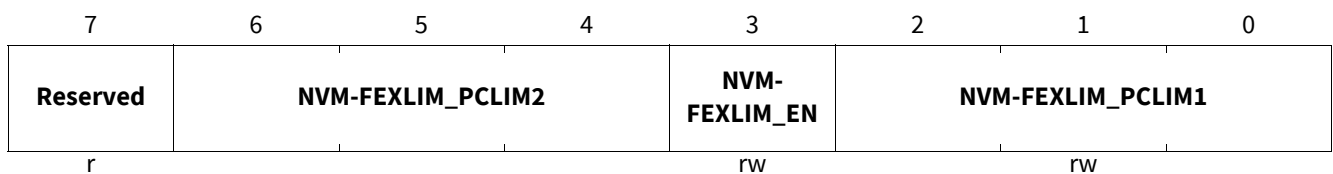

Field	Bits	Type	Description
NVM-FEXLIM_PCLIM1	2:0	rw	Frequency dependent current limitation (FEXLIM) feature: PCLIM1 region (refer to Chapter 5.13) 000 _B 5.5 A , 001 _B 6 A , 010 _B 6.5 A , 011 _B 7 A , 100 _B 7.5 A , 101 _B 8 A , 110 _B 8.5 A , 111 _B 9 A ,
NVM-FEXLIM_EN	3	rw	Enable/disable frequency dependent current limitation (FEXLIM) function (refer to Chapter 5.13) 0 _B FEXLIM is disabled , 1 _B FEXLIM is enabled ,

Non-Volatile Memory (NVM)

Field	Bits	Type	Description
NVM-FEXLIM_PCLIM 2	6:4		Frequency dependent current limitation (FEXLIM) feature: PCLIM2 region (refer to Chapter 5.13) 000 _B 5.5 A , 001 _B 6 A , 010 _B 6.5 A , 011 _B 7 A , 100 _B 7.5 A , 101 _B 8 A , 110 _B 8.5 A , 111 _B 9 A ,
Reserved	7	r	Reserved Reserved read-only area

NVM_A05_S1
 Address 05_H - Section 1 (00_H)Reset Value: 00_H

7	6	5	4	3	2	1	0
Reserved							
r							

Field	Bits	Type	Description
Reserved	7:0	r	Reserved Reserved read-only area

NVM_A05_S2
 Address 05_H - Section 2 (00_H)Reset Value: 00_H

7	6	5	4	3	2	1	0
Reserved							
r							

Field	Bits	Type	Description
Reserved	7:0	r	Reserved Reserved read-only area

NVM_A06_S0
 Address 06_H - Section 0 (00_H)Reset Value: 00_H

7	6	5	4	3	2	1	0
Reserved			DC_EWMA_m ode_DC0	NVM-VSET		NVM- LRCRT_1s	
r			rw	rw		rw	

Non-Volatile Memory (NVM)

Field	Bits	Type	Description
NVM-LRCRT_1s	0	rw	Enable 1s option for the default LRC rise time Additional option for LRCRT (refer to NVM-LRCRT) 0 _B LRC default rise time defined by NVM-LRCRT, 1 _B 1 s,
NVM-VSET	3:1	rw	Voltage set-point for default operation If the LIN communication is absent for longer than 3 seconds, the state machine switches to default operation and uses the default voltage setpoint setting, VSET (refer to Chapter 6.5). 000 _B 13.5 V, 001 _B 13.7 V, 010 _B 13.9 V, 011 _B 14.1 V, 100 _B 14.3 V, 101 _B 14.5 V, 110 _B 14.7 V, 111 _B 14.9 V,
DC_EWMA_mode_DC0	4	rw	Excitation duty cycle filter mode during Phase Signal Boost (PSB) Additional option for the DC_EWMA_mode (refer to NVM-DC_EWMA_MODE) 0 _B Filter input controlled by DC_EWMA_mode, 1 _B Filter input = 0, EWMA filter will be fed with 0% DC during PSB
Reserved	7:5	r	Reserved Reserved read-only area

NVM_A06_S1

Address 06_H - Section 1

(00_H)Reset Value: 00_H

7	6	5	4	3	2	1	0
NVM-LRCFT		NVM-IEXC100		NVM-CSHT	Reserved		
rw		rw		rw	r		

Field	Bits	Type	Description
Reserved	2:0	r	Reserved Reserved read-only area
NVM-CSHT	3	rw	Disable curve shaping at high temperature (refer to Chapter 5.2) 0 _B Curve shaping at Tj > 135°C enabled, 1 _B Curve shaping at Tj > 135°C disabled,

Non-Volatile Memory (NVM)

Field	Bits	Type	Description
NVM-IEXC100	5:4	rw	Minimum excitation current at 100% DC to avoid open load detection (refer to Chapter 5.2) 00 _B 0.75 A , 01 _B 1 A , 10 _B 1.25 A , 11 _B 1.50 A ,
NVM-LRCFT	7:6	rw	LRC fall-time The falling gradient is defined as the ramp-down time to go from 100% to 0% DC value. The falling gradient is not seen at the output DMOS, but is only calculated internally (refer to Chapter 5.12). 00 _B 1 s , 01 _B 2 s , 10 _B 2.5 s , 11 _B 3 s ,

NVM_A06_S2

Address 06_H - Section 2

(00_H)Reset Value: 00_H

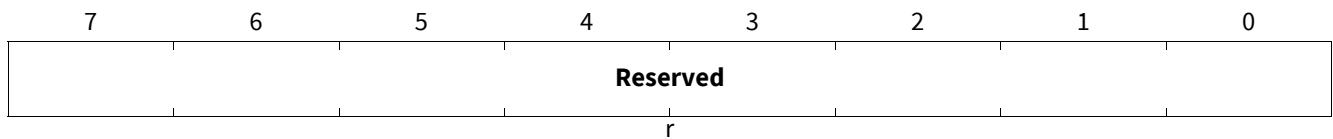

Field	Bits	Type	Description
Reserved	7:0	r	Reserved Reserved read-only area

NVM_A07_S0

Address 07_H - Section 0

(00_H)Reset Value: 00_H

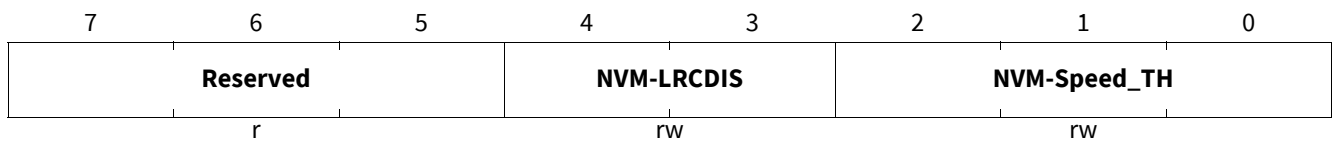

Non-Volatile Memory (NVM)

Field	Bits	Type	Description
NVM-Speed_TH	2:0	rw	Speed-dependent KiKp parameter sets (KiKp function) Speed threshold - upper value of hysteresis Nswitch2 = Nswitch1 + 400 rpm; Nswitch3 = Nswitch1 + 800 rpm; lower limit of hysteresis 200 rpm (refer to Chapter 5.15) 000 _B Nswitch1 = 2000 rpm, 001 _B Nswitch1 = 2200 rpm, 010 _B Nswitch1 = 2400 rpm, 011 _B Nswitch1 = 2600 rpm, 100 _B Nswitch1 = 2800 rpm, 101 _B Nswitch1 = 3000 rpm, 110 _B Nswitch1 = 3200 rpm, 111 _B Nswitch1 = 3400 rpm,
NVM-LRCDIS	4:3	rw	Rotor speed to disable LRC for default operation If the LIN communication is absent for longer than 3 seconds, the state machine switches to default operation and uses the default speed setting to disable the LRC function (physical parameter: n_{LRCDIS} , refer to Chapter 5.12). 00 _B 3000 rpm, 01 _B 4000 rpm, 10 _B 4800 rpm, 11 _B 6000 rpm,
Reserved	7:5	r	Reserved Reserved read-only area

NVM_A07_S1

Address 07_H - Section 1

(00_H)Reset Value: 00_H

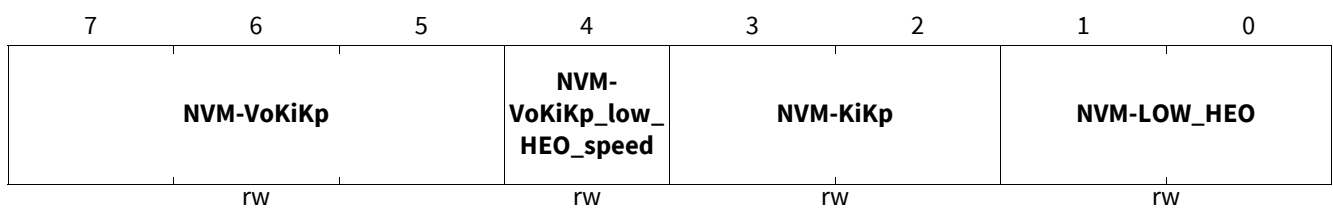

Field	Bits	Type	Description
NVM-LOW_HEO	1:0	rw	Speed-dependent lowering of the HEO limit (LowHEO function) Enabling and LowHEO voltage selection For Nswitch1 = 0 (refer to Chapter 5.17) 00 _B 15.5 V, 01 _B 15.65 V, 10 _B 15.75 V, 11 _B Low HEO function is disabled,

Non-Volatile Memory (NVM)

Field	Bits	Type	Description
NVM-KiKp	3:2	rw	KiKp function configuration (refer to Chapter 5.15) 00 _B KiKp disabled, 01 _B Simple KiKp function with KiKp set = slowest, 10 _B Simple KiKp function with KiKp set = slower, 11 _B Three stage KiKp function,
NVM-VoKiKp_low_H EO_speed	4	rw	Voltage dependent KiKp function (VoKiKp) speed dependency Activates / deactivates the speed dependency for the VoKiKp and LowHEO functions (refer to Chapter 5.16). 0 _B Speed dependency enabled, 1 _B Speed dependency disabled,
NVM-VoKiKp	7:5	rw	Voltage dependent KiKp function (VoKiKp function) configuration Enabling and VoKiKp up threshold The VoKiKp down threshold is 0.1 V lower. For options 101 _B , 110 _B and 111 _B the VoKiKp down threshold is 0.1V lower than the positive value and 0.1V higher than the negative value (refer to Chapter 5.16). 000 _B VoKiKp disabled, 001 _B 0.35 V, 010 _B 0.5 V, 011 _B 0.65 V, 100 _B 0.8 V, 101 _B +/- 0.5V, VoKiKp is activated for an upper and lower threshold 110 _B +/- 0.75V, VoKiKp is activated for an upper and lower threshold 111 _B +/- 1V, VoKiKp is activated for an upper and lower threshold

NVM_A07_S2

Address 07_H - Section 2

(00_H)Reset Value: 00_H

7	6	5	4	3	2	1	0
Reserved						NVM-LOCK_EN	Reserved
						rw	r

Field	Bits	Type	Description
Reserved	0	r	Reserved Reserved read-only area
NVM-LOCK_EN	1	rw	Enable NVM Lock Setting this NVM field makes the NVM write-protected and protect it from any modification afterwards. <i>Note: Once this bit is set, the NVM will get write-protected. It is not possible to release the write-protection once it has been set.</i> 0 _B NVM can be programmed, 1 _B NVM is locked,

Non-Volatile Memory (NVM)

Field	Bits	Type	Description
Reserved	7:2		Reserved Reserved read-only area

Application information

10 Application information

Note: The following information is given as a hint for the implementation of the device only and shall not be regarded as a description or warranty of a certain functionality, condition or quality of the device.

This is the description how the TLE8881-2 is used in its alternator environment.

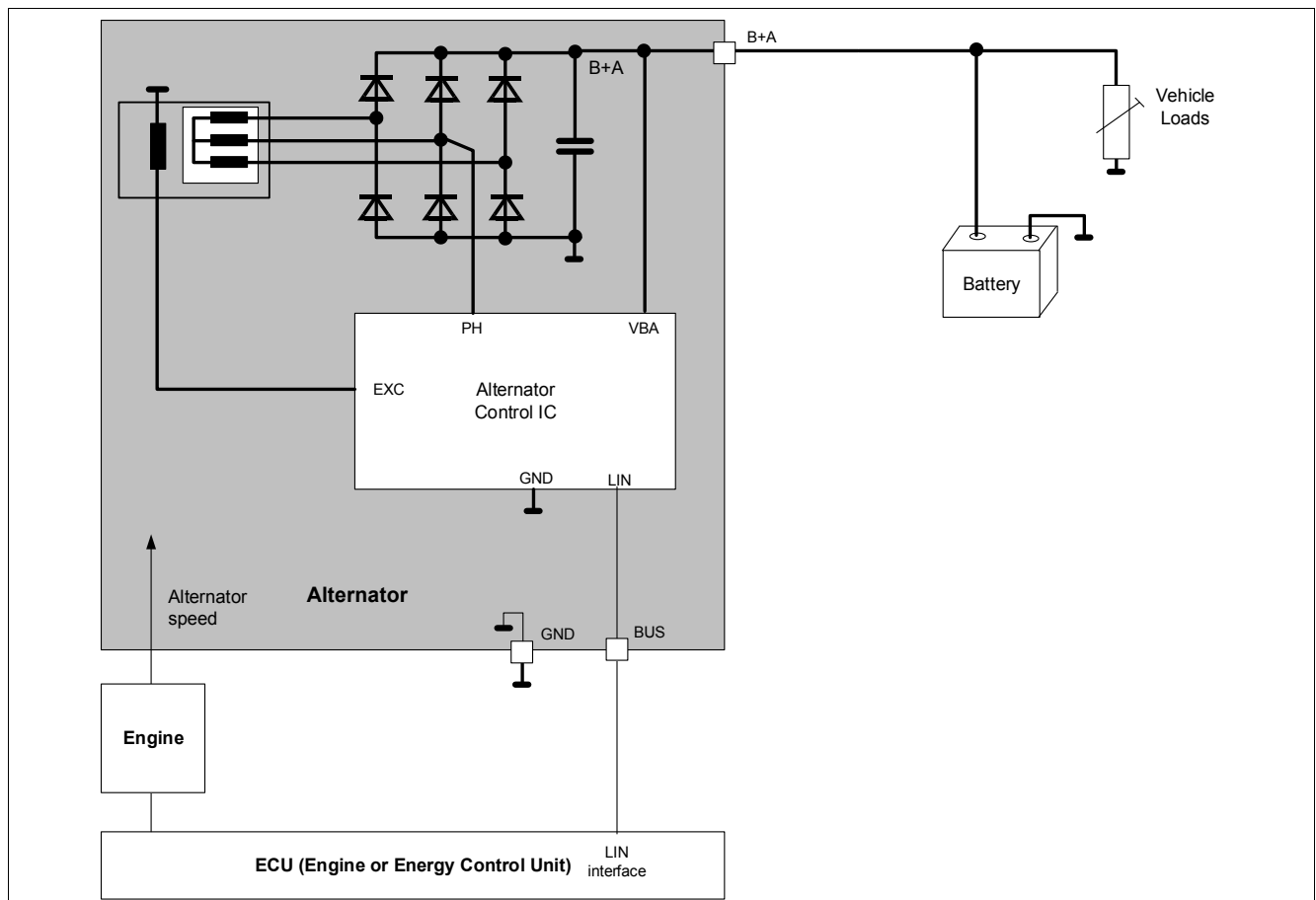

Figure 26 Application diagram

Note: This is a very simplified example of an application circuit. The function must be verified in the real application.

The TLE8881-2 regulates the alternator output to an adjustable reference voltage. The regulation is achieved by varying the magnetization in the alternator. The magnetization is dependent on the current in the rotor winding (excitation). The current is dependent on the duty cycle of the excitation high-side output (terminal EXC).

The TLE8881-2 supply (VBA) is connected to the alternator output. The filtered supply voltage is the feedback voltage used by the control circuit.

One of three stator winding voltages (PH) is connected to the TLE8881-2. The phase input is used for the rotor speed measurement and stator monitoring, as well as the self-start detection.

Application information

10.1 EMC and ESD

ISO and ESD pulses are applied to the alternator. The TLE8881-2 does not see all disturbances at its pins due to connectors, the alternator and the diodes. The sensitivity depends on the TLE8881-2 and the complete alternator system.

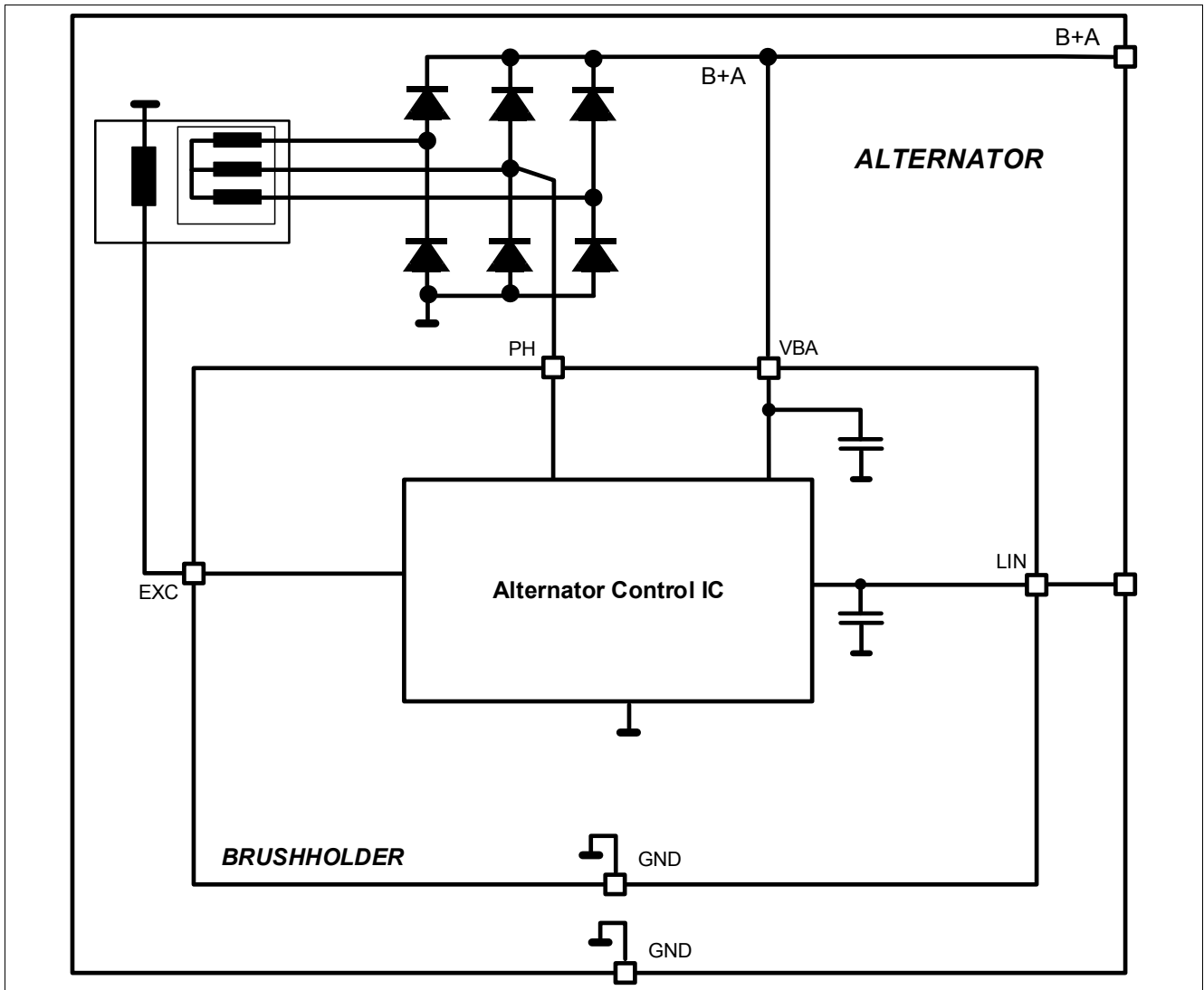

Figure 27 Application overview for EMC

The stated intend is to ensure all EMC and ESD requirements without any TLE8881-2 external devices.

The external passive devices indicate their possible use only.

In the car system, the TLE8881-2 will be used as a LIN-Slave.

The device will be tested or referenced according to the VDA Test Spec “2009-12-02 Common EMC-requirements on LIN-Interfaces” at IBEE Zwickau.

10.2 Further application information

- For further information you may contact <https://www.infineon.com>

11 Package information

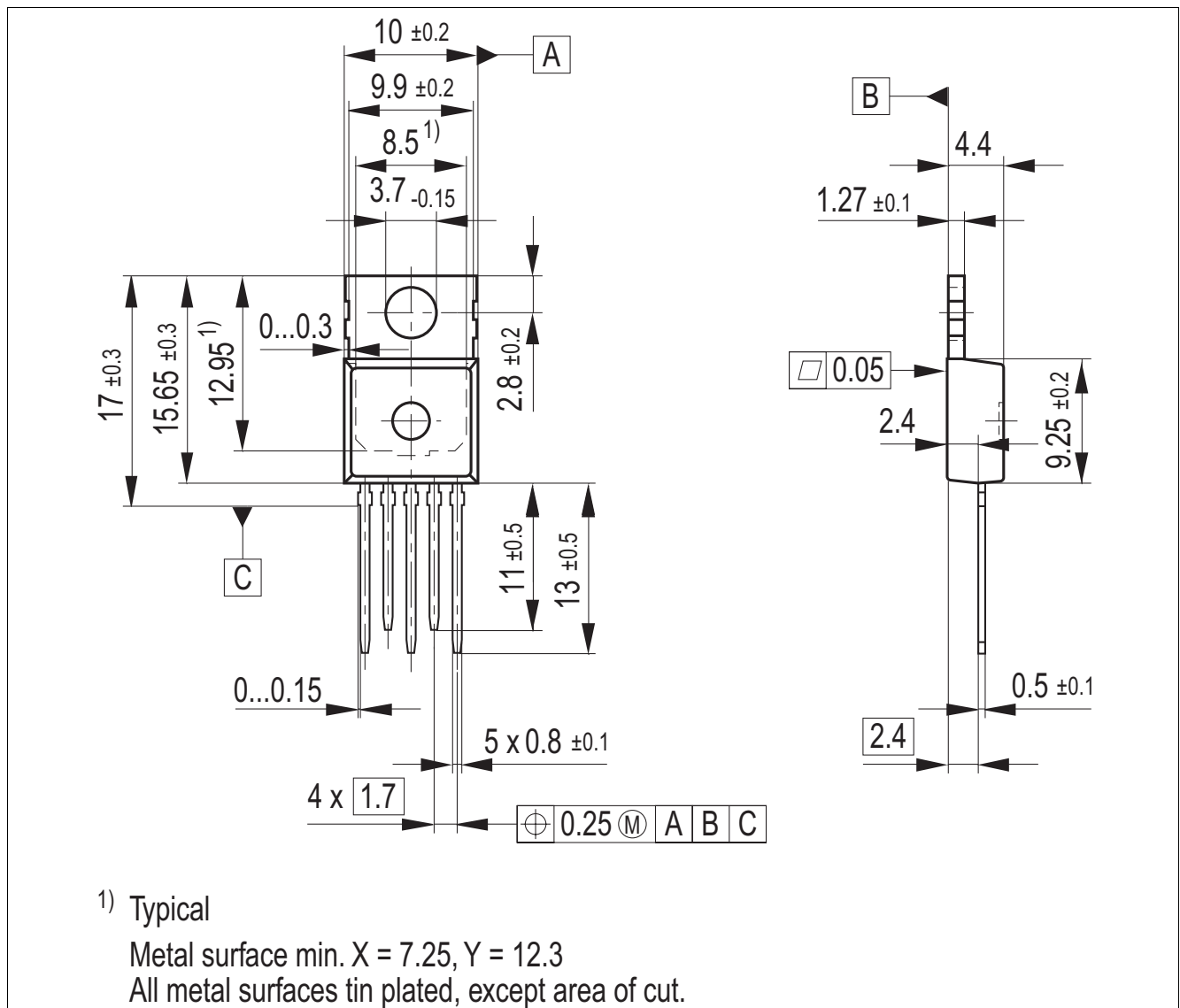

Figure 28 PG-TO-220-5-12 Straight Leads¹⁾

Green Product (RoHS compliant)

To meet the world-wide customer requirements for environmentally friendly products and to be compliant with government regulations the device is available as a green product. Green products are RoHS-Compliant (i.e Pb-free finish on leads and suitable for Pb-free soldering according to IPC/JEDEC J-STD-020).

Further information on packages

<https://www.infineon.com/packages>

1) Dimensions in mm

Revision history

12 Revision history

Revision	Date	Changes
1.00	2019-05-29	Datasheet released

Trademarks

All referenced product or service names and trademarks are the property of their respective owners.

Edition 2019-05-29

Published by

Infineon Technologies AG

81726 Munich, Germany

© 2019 Infineon Technologies AG.

All Rights Reserved.

Do you have a question about any aspect of this document?

Email: erratum@infineon.com

Document reference

Doc_Number

IMPORTANT NOTICE

The information given in this document shall in no event be regarded as a guarantee of conditions or characteristics ("Beschaffheitsgarantie").

With respect to any examples, hints or any typical values stated herein and/or any information regarding the application of the product, Infineon Technologies hereby disclaims any and all warranties and liabilities of any kind, including without limitation warranties of non-infringement of intellectual property rights of any third party.

In addition, any information given in this document is subject to customer's compliance with its obligations stated in this document and any applicable legal requirements, norms and standards concerning customer's products and any use of the product of Infineon Technologies in customer's applications.

The data contained in this document is exclusively intended for technically trained staff. It is the responsibility of customer's technical departments to evaluate the suitability of the product for the intended application and the completeness of the product information given in this document with respect to such application.

For further information on technology, delivery terms and conditions and prices, please contact the nearest Infineon Technologies Office (www.infineon.com).

WARNINGS

Due to technical requirements products may contain dangerous substances. For information on the types in question please contact your nearest Infineon Technologies office.

Except as otherwise explicitly approved by Infineon Technologies in a written document signed by authorized representatives of Infineon Technologies, Infineon Technologies' products may not be used in any applications where a failure of the product or any consequences of the use thereof can reasonably be expected to result in personal injury.

X-ON Electronics

Largest Supplier of Electrical and Electronic Components

Click to view similar products for [Gate Drivers](#) category:

Click to view products by [Infineon](#) manufacturer:

Other Similar products are found below :

[00053P0231](#) [56956](#) [57.404.7355.5](#) [LT4936](#) [57.904.0755.0](#) [5882900001](#) [00600P0005](#) [00-9050-LRPP](#) [00-9090-RDPP](#) [5951900000](#) [01-1003W-10/32-15](#) [0131700000](#) [00-2240](#) [LTP70N06](#) [LVP640](#) [5J0-1000LG-SIL](#) [LY1D-2-5S-AC120](#) [LY2-US-AC240](#) [LY3-UA-DC24](#) [00576P0020](#) [00600P0010](#) [LZN4-UA-DC12](#) [LZNQ2M-US-DC5](#) [LZNQ2-US-DC12](#) [LZP40N10](#) [00-8196-RDPP](#) [00-8274-RDPP](#) [00-8275-RDNP](#) [00-8722-RDPP](#) [00-8728-WHPP](#) [00-8869-RDPP](#) [00-9051-RDPP](#) [00-9091-LRPP](#) [00-9291-RDPP](#) [0207100000](#) [0207400000](#) [01312](#) [0134220000](#) [60713816](#) [M15730061](#) [61161-90](#) [61278-0020](#) [6131-204-23149P](#) [6131-205-17149P](#) [6131-209-15149P](#) [6131-218-17149P](#) [6131-220-21149P](#) [6131-260-2358P](#) [6131-265-11149P](#) [CS1HCPU63](#)