

規格承認書

PECIFICATION FOR APPROVAL

客戶
CUSTOMER : _____
項目
ITEM : 电磁无源一体蜂鸣器（外部驱动）
型號
TYPE : GMC1614YB-16-140R2048 通用型（电阻 16-140 欧）
描述
DESCRIPTION : ϕ 16.0 x 14.0 mm 2048Hz 16-140 Ω /3-15V \geq 85dB PBT 材质 P=6.5mm
客戶料號
CUSTOMER NO. : _____
規格書號
SPECIFICATION NO.: _____
版本
EDITION NO. : V1.0
日期
DATE : 2

客戶承認

CUSTOMER CONFIRM AND SIGN

檢查 TESTED BY	審核 CHECKED BY	承認 APPROVED BY

東莞市贏海電子有限公司

DONGUAN INGHAI ELECTRONICS CO.,LTD

製作 ISSUED BY	審查 CHECKED BY	確認 APPROVED BY
周明	陈铭	

地址：廣東省東莞市長安鎮上沙第五工业区新春路 1 号新春科技园
電話 / TEL: 0769-83060958 傳真 / FAX: 0769-81608993
網址: HTTP://WWW.INGHAI.COM

DONGGUAN INGHAI ELECTRONICS CO.,LTD

Model NO: GMC1614YB-16-140R2048

A: DIMENSIONS:

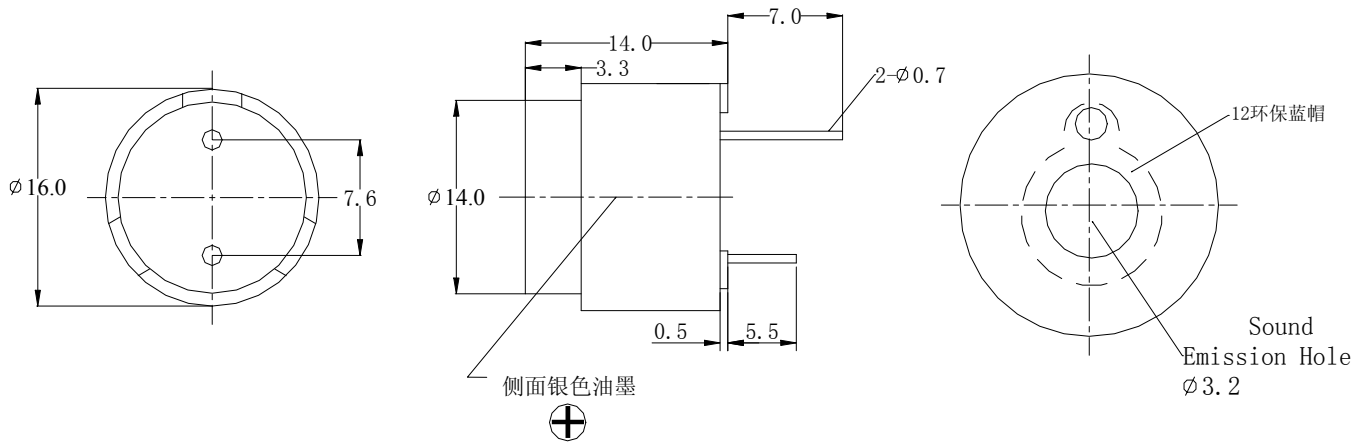

Tolerance:±0.5mm Unit:mm

B: SPECIFICATIONS

Model NO	GMC1614YB
Rated Voltage	2-15V
Operating Voltage	2~15V
Max.Rated Current	Max.80mA
Sound Pressure level(dB)at10cm/2048HZ	Min.85dB
Resonant Frequency	2048Hz
Coil Resistance	16-140±15%
Operating Temperature	-20 °C~+70 °C
Storage Temperature	-30 °C~+80 °C
Case material and color	PBT / Black

Measuring condition

Part shall be measured under a condition (Temperature: 5~35°C, Humidity: 45%~85%R.H., Atmospheric pressure: 860 ~1060hPa) unless the standard condition (Temperature: 25±3°C, Humidity: 60±10%R.H. Atmospheric pressure: 860 ~1060hPa) is regulated to measure.

C: Acoustic Characteristics:

The oscillation frequency, current consumption and sound pressure are measured by the measuring instruments shown below

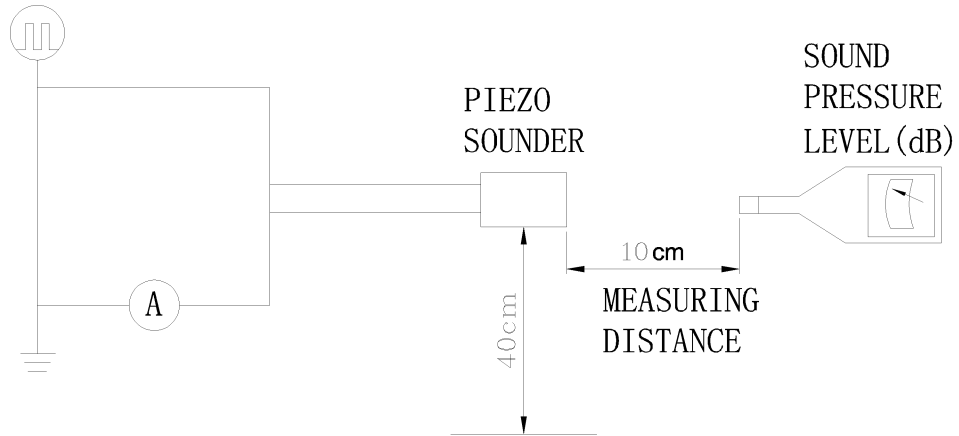

In the measuring test, buzzer is placed as follows:

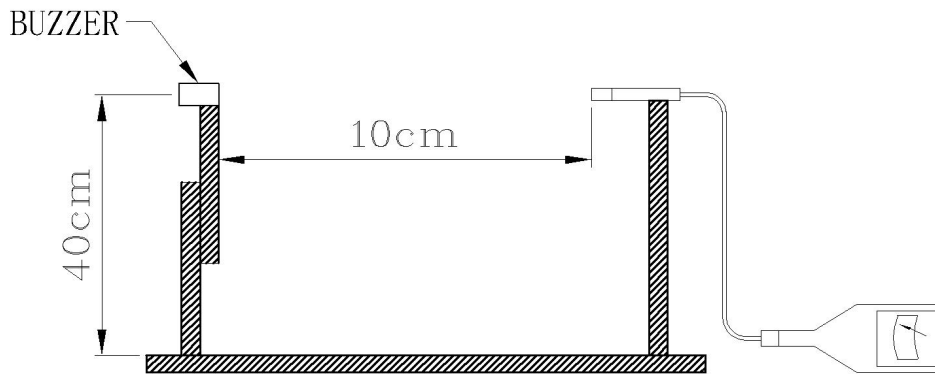

D: Typical Frequency Response Curve

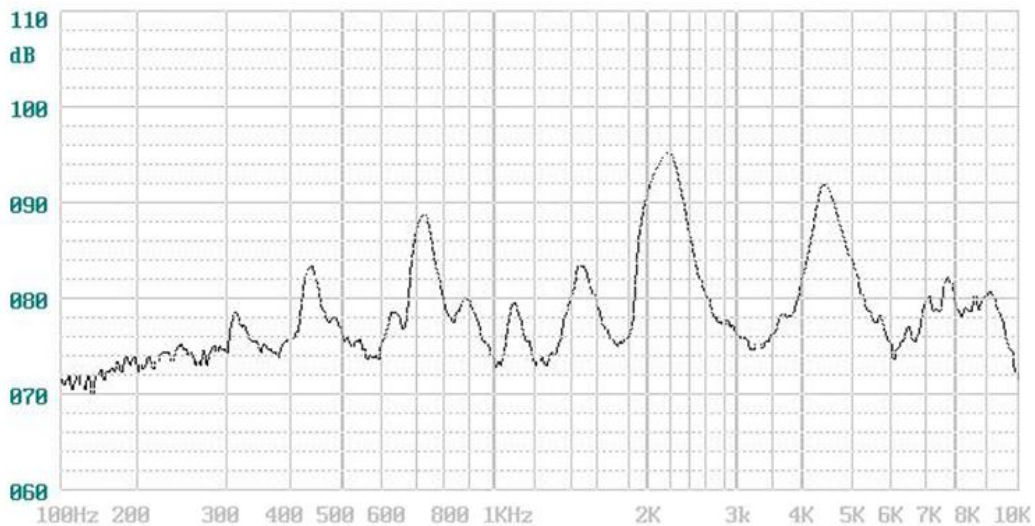

E: Reliability Test

After any following tests the part shall meet specifications without any degradation in appearance and performance except SPL. SPL shall not deviate more than -10 dB from the initial value

1. Ordinary Temperature Life Test

The part shall be subjected to 96 hours at $25 \pm 10^\circ\text{C}$. Input rated voltage Resonant frequency, 1/2 duty Square wave.

2. High Temperature Test

The part shall be capable of with standing a storage temperature of $+80^\circ\text{C}$ for 96 hours.

3. Low Temperature Test

The part shall be capable of with standing a storage temperature of -30°C for 96 hours.

4. Humidity Test

Temperature: $+40^\circ\text{C} \pm 3^\circ\text{C}$ Relative Humidity: 90% ~ 95% Duration: 48 hours and expose to room temperature for 6 hours

5. Temperature Shock Test

Temperature: 70°C /1hour → 25°C /3hours → -30°C /1hour → 25°C /3hours (1cycle)
Total cycle: 10 cycles

6. Drop Test

Standard Packaging From 120mm (Drop on hard wood or board of 5cm thick, three sides, six plain.)

7. Vibration Test

Vibration: 1000cycles /min. Amplitude: 1.5mm, Duration: 1 hour in each 3 axes

Note:

As this product is not protected from foreign material entering, please make sure that any foreign materials (e.g. magnetic powder, washing solvent, flux, corrosive gas) do not enter this product in your production processes. The functional degradation (e.g. SPL down) may occur if foreign material enter it.

X-ON Electronics

Largest Supplier of Electrical and Electronic Components

Click to view similar products for [Piezo Buzzers & Audio Indicators](#) category:

Click to view products by [INGHAI](#) manufacturer:

Other Similar products are found below :

[PFD-21A29W](#) [PLD-21N30W](#) [REM-6027F-1.5](#) [RH1020C-010-NFP-G-NL](#) [PFD-27N36W](#) [KBS-20DA-7AS](#) [KBS-27DA-5C-105](#)
[RFS5015382PNL](#) [MSR516NP](#) [DMT-1606S-NL](#) [OMT112](#) [SCE016SD3CM4B](#) [DMT-09-1-4B-NL](#) [HBO0302C-58/1248](#) [AT-3045-TF-LW110-R](#) [SMA-17-S](#) [BMS3650L-LF](#) [SMT-0540-T-7-R](#) [SMT-0540-T-2-R](#) [AT-0927-TT-2-R](#) [AT-2310-T-LW100-R](#) [SMI-1324-TW-5V-4-R-T/R](#)
[SC0715BL](#) [AI-1027-TWT-5V-R](#) [SC235AF](#) [SMT-0827-TW-5V-R](#) [AT-2830-TWT-R](#) [AT-1220-TT-5-R](#) [AT-1220-TT-10-R](#) [AT-1127-ST-2-R](#)
[AT-1220-TWT-5V-R](#) [AT-1750-TFL-LW95-R](#) [AI-2437-TWT-R](#) [SMT-1427-S-R](#) [SMT-1127-S-R](#) [AI-3245-TF-LW95-R](#) [AI-2438-TT-R](#)
[AB2040B](#) [SMI-1324-TW-3V-R](#) [SMT-1324-TW-5V-R](#) [AT-2429-TWT-R](#) [AI-1223-TWT-12V-3-R](#) [AI-1440-TWT-24V-2-R](#) [AB4113B](#) [AI-1223-TWT-5V-4-R](#) [X-4028-P-C32-R](#) [AI-2304-TF-LW120-12V-R](#) [AI-4329-P-SP28-R](#) [XL-5020-TF-LW150-S-R](#) [SMA-30-P17.5](#)