

規格承認書

PECIFICATION FOR APPROVAL

客戶
CUSTOMER : 立創
項目
ITEM : 单指向驻极体电容咪头 (ECM)
型號
TYPE : GMI6027U-2C34DB
描述
DESCRIPTION : ϕ 6.0 x H2.7mm 背极式 1033 -34dB 0.68K 1.5V S/N: \geq 58 dBA
客戶料號
CUSTOMER NO. :
規格書號
SPECIFICATION NO.:
版本
EDITION NO. : V1.2
日期
DATE : 2019-12-27

客戶承認

CUSTOMER CONFIRM AND SIGN

檢查 TESTED BY	審核 CHECKED BY	承認 APPROVED BY

東莞市贏海電子有限公司

DONGUAN INGHAI ELECTRONICS CO.,LTD

製作 ISSUED BY	審查 CHECKED BY	確認 APPROVED BY
周明	李林	

地址：廣東省東莞市長安鎮廈邊元灶頭工業區 16-6 號
電話 / TEL: 0769-83060958 傳真 / FAX: 0769-81608993
網址: [HTTP://WWW.INGHAI.COM](http://www.inghai.com)

A. SCOPE

This specification applies electret condenser microphone, GMI6027U-2C34DB

B. SPECIFICATION

■ Test condition: $RL=0.68K\Omega$ $VS=1.5V$ $TEMP=25^{\circ}C\pm 2^{\circ}C$ Related humidity= $65\pm 5\%$

No.	Item	Symbol	Unit	Specification	Condition
1	Directivity			Unidirectional	
2	Sensitivity	S	dB	-34±3	f=1KHz, 0dB=1V/ Pa
3	Standard operating voltage	Vs	V	1.5	
4	Output impedance	Zout	K Ω	≤ 0.68	f=1KHz, 1Pa
5	Frequency		Hz	100-10,000	
6	Max operating voltage		V .	10	
7	Sensitivity reduction	$\Delta S-Vs$	dB	-3	f=1KHz, 1Pa vs=3.0VDC to 1.5VDC
8	Max. current consumption	IDSS	mA	≤ 0.5	
9	Signal to noise ration	S/N	dBA	≥ 58	
10	Max input sound level	SPL	dB	110	
11	Operation temp.		$^{\circ}C$	-20 ~+60	
12	Storage temp.		$^{\circ}C$	-30 ~+70	
13	Dimension		mm	$\varphi 6.0 \times H2.7$	See appearance drawing
14	Terminal			Terminal	See appearance drawing
15	Approvals			RoHs FCC	

We use "Pascal(Pa)" indication of sensitivity as per the recommendation of I.E.C.(International Electro technical Commission)

The Sensitivity of "Pa" will increase 20dB comparing with "ubar" indication

Example: -60dB(0dB=1V/ubar) =-40dB(1V/Pa)

C. TYPICAL FREQUENCY RESPONSE CURVE

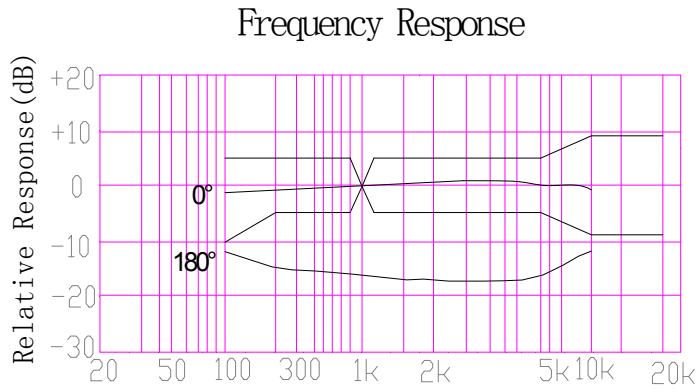

Microphone Response Tolerance Window

Frequency (Hz)	Lower Limit (dB)	Upper Limit (dB)
100	-5	5
200	-5	5
800	-5	5
1000	0	0
1200	-5	5
2000	-5	5
5000	-5	5
10000	-8	8

D. APPEARANCE DRAWING

Unit: mm

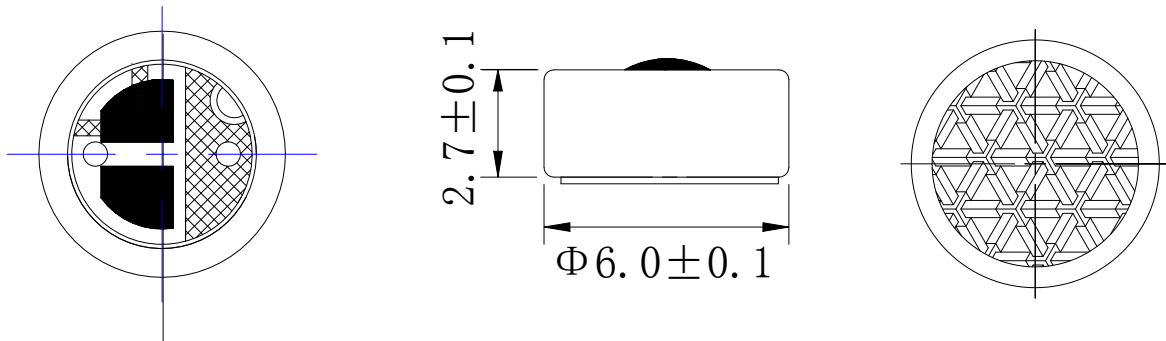

E. MEASUREMENT CIRCUIT

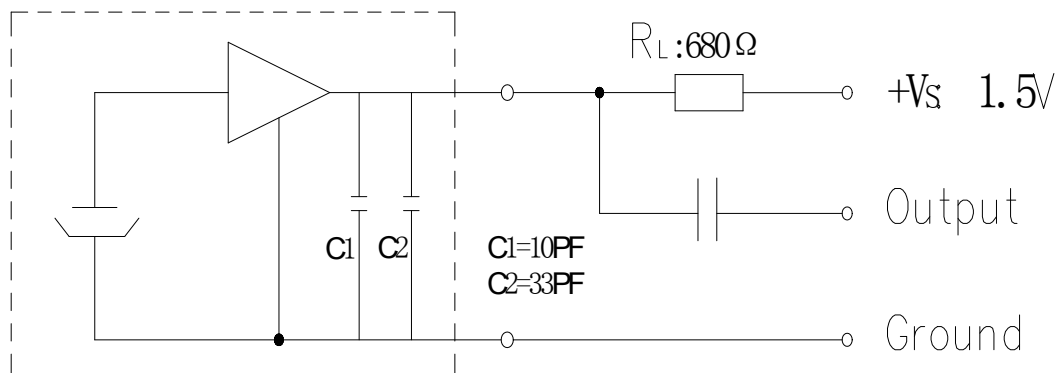

F.Explode Drawing

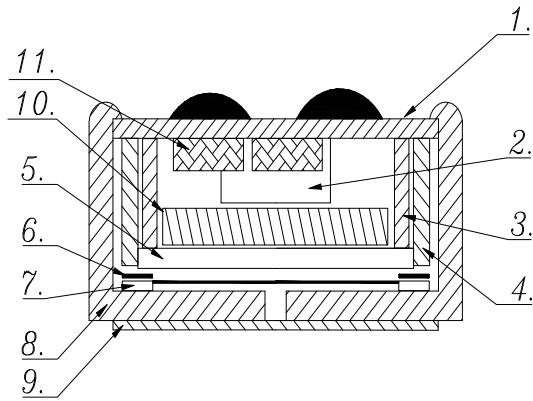

1	PCB	7	背极膜
2	FET	8	外壳
3	金环	9	防水网
4	塑环	10	阻尼棉
5	背极板	11	电容
6	垫片	12	

G. 可靠性试验 Reliability Test

经过以下所有试验在 20℃的条件下放置 3 小时后,麦克风的灵敏度与试验前比较变化在 3dB 以内

After any following tests, the sensitivity of the microphone to be within $\pm 3\text{dB}$ of initial sensitivity after 3hours of conditioning at 20℃

5-1 振动试验 Vibration	周波数 1/Frequency1:10Hz~55Hz 振幅/Amplitude:1.52mm 变化/Change of Frequency:1 octave/min 3 方向,各 2 小时/hours in each of 3 axes
5-2 高温试验 Dry Heat	+60±5℃ for 96 hours
5-3 低温试验 Dry Cold	-20±5℃ for 96 hours
5-4 高温高湿试验 Damp Heat	90%~95%RH, +60±5℃ for 96 hours
5-5 温度循环试验 Temperature cycles	-20℃ ↔ 25℃ ↔ 60℃ (2h) (1h) (2h) (1h) (2h) × 10 cycles
5-6 跌落试验 Packing drop test	Height:1m 顺序:三个面各跌 10 次 Procedure:10 times from each of 3 axes
5-7 温度冲击试验 Temperature impact test	-20℃ ↔ 60℃ 30min 30s 30min × 10 cycles
5-8 静电冲击试验 Electrostatic shock test	4000V(contact), 8000V(air) × 10 axes
备注 Note	
6-1 工作温度范围 Operation Temperature	-20℃~60℃
6-2 储存温度范围 Storage Temperature	-30℃~70℃

H. 焊接条件 Soldering Condition

7-1 焊接使用 90W 的烙铁。

The soldering copper of a type of 90W shall be applied

焊接条件

Soldering Condition.

7-2 电烙铁表面温度 $320 \pm 10^\circ\text{C}$

The temperature of the working surface of the soldering copper shall be $320 \pm 10^\circ\text{C}$

7-3 焊接时把麦克风嵌入散热能力强的金属块内。

ECM shall be soldered fixed on the metal block(heat sink)which has the higher radiation effects said heat sink Shall contact with of ECM.

7-4 焊接时间控制在 2~3 秒内。

time for each terminal shall be 2~3 sec.

7-5 焊接后不能出现针孔。

The pinhole after soldering shall be avoided.

7-6 静电容易破坏麦克风必须采取措施避免（电烙铁接地，戴静电环等。）

ECM may easily destroyed by the static electricity and the countermeasure for eliminating the static electricity (the ground for soldering copper, for worktable and for human body) shall be executed.

7-7 散热板形状 Shape of heat sink

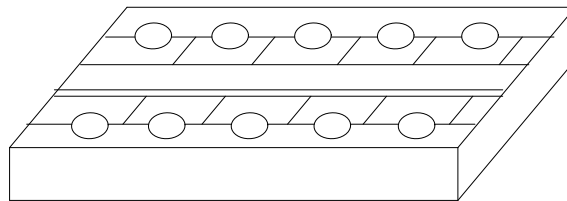

7-8 固定部孔形状 Shape of hole at fixed part

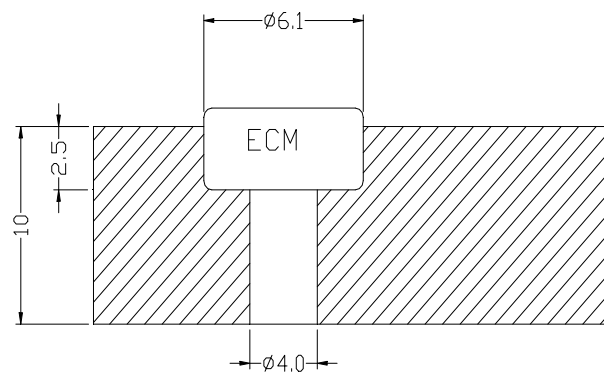

X-ON Electronics

Largest Supplier of Electrical and Electronic Components

Click to view similar products for [Microphones](#) category:

Click to view products by [INGHAI](#) manufacturer:

Other Similar products are found below :

[BCM4013OLFC-42-JST-ZHR-2](#) [TO38-30702-B20](#) [FG-23329-P142](#) [254-ECM6441-RO](#) [AOM-6742P-2-R](#) [SPM04C-38/1186-T/R](#) [POM-2244L-C33-R](#) [AOM-6545P-R](#) [ANM-5254L-R](#) [AOM-6738L-R](#) [AOM-6738P-R](#) [BCM4013OSBC-42 LF](#) [ANM-5254L-LW100-R](#) [AOM-4540P-R](#) [PUM-3046L-R](#) [TOM-1545L-R](#) [POM-2738L-LW100-R](#) [POM-2738P-C33-R](#) [POM-3542P-R](#) [POM-3535L-3-LW100-R](#) [POW-2742P-C3310-B-R](#) [AOM-6738L-LW100-R](#) [AOW-4544P-C3310-B-R](#) [POM-2735P-R](#) [POW-2742L-C3310-B-R](#) [PUM-5250L-C3310-R](#) [POM-5038P-C3310-R](#) [TOW-1242P-R](#) [POM-5046P-C3310-R](#) [TC-32348-000](#) [TC-32485-000](#) [BCM9745-44](#) [BCM9767P](#) [LD-MC-6035](#) [LD-MC-9765](#) [CMC-4015-40P](#) [PMO-6022SN-42UQ](#) [PMOF-6027WN-44KDQ](#) [PMO-4015PN-42KDQ](#) [CMC-6027-42L100](#) [PMO-6027P-40KDQ](#) [PMOF-6050S-44UQ](#) [PMO-4530PN-47UQ](#) [PMO-4015MN-42HXQ](#) [CMC-6036-40T](#) [CMC-4015-25T](#) [CMC-6027-24T](#) [PMOF-9767NP-46DQ](#) [PMOF-9745W-42UQ](#) [PMOF-9745P-39UQ](#)