

# 規格承認書

## PECIFICATION FOR APPROVAL

客戶  
CUSTOMER : 立創

項目  
ITEM : 微型揚聲器(塑壳內磁)

型號  
TYPE : GSPK3070PN-8R2W-L100 (焊線可定制)

描述  
DESCRIPTION : L69.9 x W31 x H8.6 MM 磁芯 12.5\*2mm 8Ω 2W S.P.L: 86 dB+/- 3dB

客戶料號  
CUSTOMER NO. :

規格書號  
SPECIFICATION NO.:

版本  
EDITION NO. : V1.0

日期  
DATE : 2020-6-15

### 客戶承認

#### CUSTOMER CONFIRM AND SIGN

檢查 TESTED BY	審核 CHECKED BY	承認 APPROVED BY

### 東莞市贏海電子有限公司

#### DONGUAN INGHAI ELECTRONICS CO.,LTD

製作 ISSUED BY	審查 CHECKED BY	確認 APPROVED BY
周明	刘承成	

地址：廣東省東莞市長安鎮上沙第五工業區新春路1號新春科技園  
電話 / TEL: 0769-83060958 傳真 / FAX: 0769-81608993  
網址: [HTTP://WWW.INGHAI.COM](http://www.inghai.com)

## 1. 范围/SCOPE

该规格书适用于移动电话等使用的扬声器单元。

This Specification Applies to The Speaker, Used In Mobilephone sec.

## 2. 型号/PART No

客户型号/Customer'S Part no:

3. 本公司型号/Our Part no : GSPK3070PN-8R2W-L100

## 4. 尺寸与重量/TYPE

69.9\*31\*8.6mm 电动式 Rectangle Dynamic type

## 5. 尺寸与重量/DIMENSION

尺寸: 69.9\*31\*8.6mm 参考外观图面 (Figure.3)

Dimension: Refer To The Appearance Drawing. (Figure.3)

重量: 11 /±0.5g

Weight: 11/±0.5g

## 6. 标准测试条件/STANDARD TEST CONDITION

在没有其他特别指定时, 测试应如下所记的标准测试条件下进行。

Unless Otherwise Specified, The Test Shall Be Made Under The Standard Conditions.

- 温度/Temperature : 17°C~25°C (Standard: 20.5°C)
- 相对温度/Relative Humidity : 45%~85% (Standare: 65%)
- 大气压力/Pressure : 86Kpa~106Kpa(Standard: 101.3 Kpa)

## 7. 使用与储存温度/OPERATION AND STORAGE TEMIPERATURE

- 使用温度/Operation Temperature : -40°C~75°C
- 储存温度/Storage Temperature : -30°C~ 70°C

## 8. 电气特性规格/Electrical Specification

参考特性规格页面/Refer To The Appearance Page

## SPEAKER SPECIFICATION (P3/7)

### 1. 外观与尺寸: 参考附图

Appearance & Dimensions: Refer To The Appearance Drawing

### 2. 额定/Rated

项目/Items	规格/Specification	条件/Conditions
额定阻抗/Rated Impedance	8.0 Ohm±20%	at 1kHz 100 mV
额定输入功率/Rated input power	2.0 W	
最大输入功率/Max input power	3.0 W	
最低共振频率 /Resonant Frequency	450±25% Hz	1V Input
灵敏度/Sound pressure level	86±3dB	SPL at 1.05kHz in Average (0dB SPL=20μPa) Measuring condition: 1.0W (Sine wave) 0.5m measured with baffler shown in Figure4
有效频率范围 /Frequency response	FO~20KHz	
总谐波失真/THD	≤5% at 1kHz	

### 3. 动作检查/OPERATIONAL TEST

项目/ITEM	信号/SIGNAL	输入/INPUT	扫频范围/SWEEP RANGE
SWEEP TEST	Sine Wave	2W(4V)	200~5000Hz

- 在动作检查中不得有异常音出现
- Without Abnormal Sound In Operation Test.

### 4. 负荷实验/LOAD TEST

项目/ITEM	信号/SIGNAL	I 输入/INPUT	驱动时间 DRIVING TERM
Continuous load Test	PINK Noise/Jis Filter (Refer To Jis C5531)	2w(4V) (RMS)	96hours (with 5cc test box)

- 在负荷实验后不得有异常音出现,灵敏度应保持在限度范围内。
- Without Abnormal Sound After Test, And The S.P.L Shall Be In The Limit.
- 负荷实验应使用粉红噪声信号
- Running Test Shall Use pink Noise Signal

Name

**MICRO SPEAKER**

Customer's Part No:

Our Part No: **GSPK4030PN-1M4R3W-L**

## SPEKER SPECIFICATION(P4/7)

### 5. 可靠性实验/Reliability Test

项目/Item	规格/Specification	判定/Judgement
高温放置实验 Hightemp.Storage Test	75°C±2°C/20~40%RH/96HR & 20°C±5°C,1H	实验完成后产品应满足上述第 1, 2, 3 项要求. Clause 1, 2, 3 Shallbe Satisfied Afier Test
低温放置实验 Lowtemp.Storage Test	-40±2°C/20~40%RH/96HR & 20°C±5°C,1H	
耐湿实验 Humidity Test	40°C ± 2°C / 90~95%RH/96HR & 20°C ± 5°C, 1H	
耐高温负荷实验 Heatrunning Test	75°C ± 2°C / 20~40%RH/-	
耐低温负荷实验 Coldrunning Test	-40°C ± 2°C / 20~40%RH/-	
热冲击实验 Thermalshock Test	+75°C ± 2°C — 30°C ± 2°C — +85°C ± 2°C 5Cycles	
震动实验 Vibration Test	10Hz—40Hz—10Hz/60s, 1.0mm (X: 2H, Y: 2B)	

### 6. 跌落实验/SHOCK TEST

项目/Item	条件/Condition	判定/Judgement
Drop Test	产品在包装状态下,从 1 米高处向混凝土地面跌落:1角:1次:3边:每条边 1次:6面:每 1 面 1 次 Speaker Shall Be Packed In The Carton And Dropped The Concrete Floor(H:1m)	实验完成后新产品应满足上述第 3 项要求 Clause 3 Shallbe Satisfied Afier Test

Name

**MICRO SPEAKER**

Customer's Part No:

Our Part No: **GSPK4030PN-1M4R3W-L**

## SPEKER SPECIFICATION(P5/7)

### 典型频响曲线 /TYPICAL FREQUENCY RESPONSE CURVE

12/21/2003 06:04

CRY6125Y 扬声器测试仪 V91

无框 滤波器1次

DCR= \_\_\_\_\_  $\Omega$       0 1000Hz灵敏度 : 111.02 dB      ACZ: \_\_\_\_\_  $\Omega$       Qm: \_\_\_\_\_  
 Veq= \_\_\_\_\_ dm3  $\rightarrow$ 0 平均灵敏度 : 105.74 dB      Zm : \_\_\_\_\_  $\Omega$       Qe: \_\_\_\_\_  
 Dist.=010 cm      F1= 10Hz      F2=40000Hz      F0 : \_\_\_\_\_ Hz      Qt: \_\_\_\_\_  
 型号: \_\_\_\_\_  
 0 dB 参考值为 : 20.0  $\mu$ Pa      扫频速度 : 002 ms 慢速      扫频模式 : 1/24 Oct

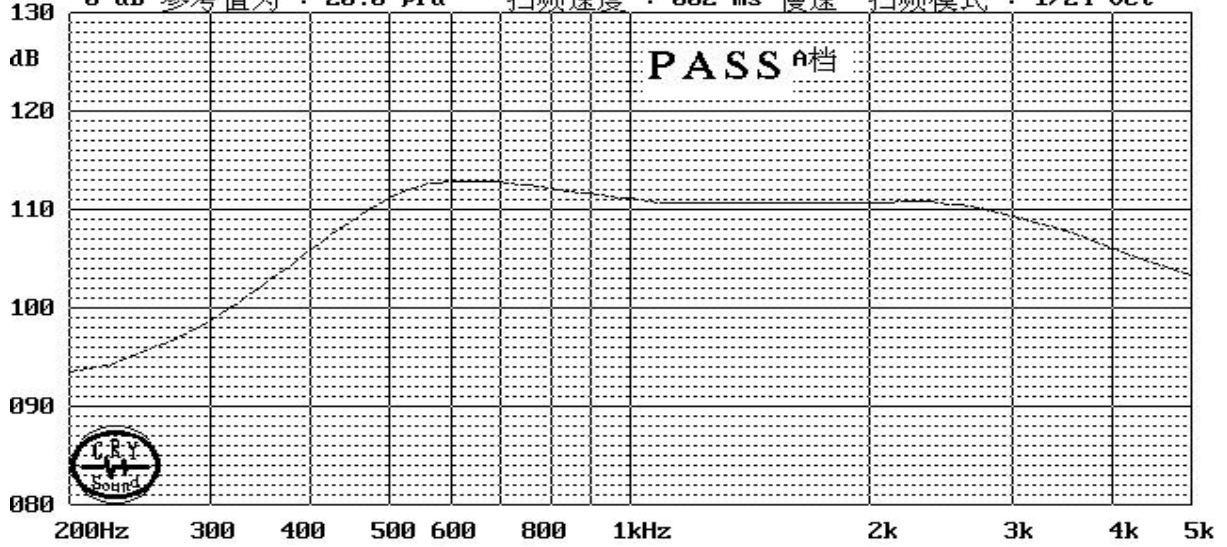

Figure.1

### FREQUENCY MEASURING CIRCUIT AND EAR PIECE

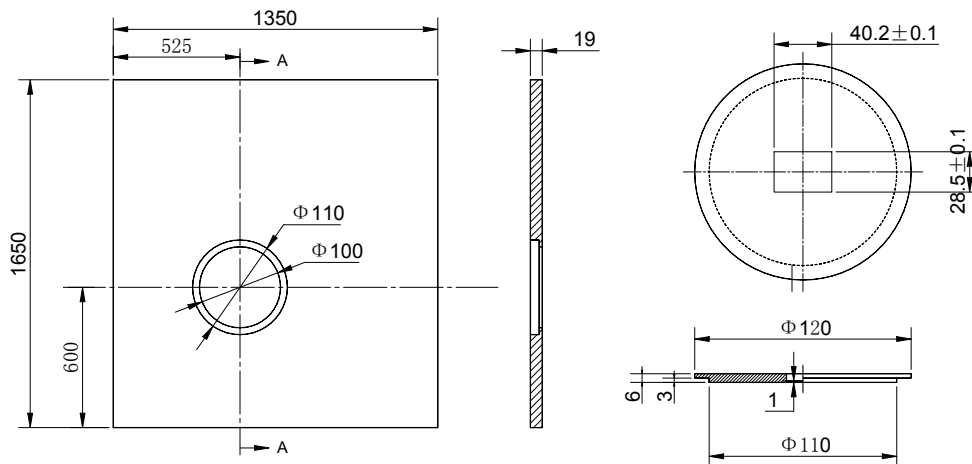

Figure.2

Name

**MICRO SPEAKER**

Customer's Part No:

Our Part No: **GSPK4030PN-1M4R3W-L**

## SPEKER SPECIFICATION(P6/7)

### ■ 产品外观图/ DIMENSIONAL DRAWING

尺寸公差:  $\pm 0.3\text{mm}$

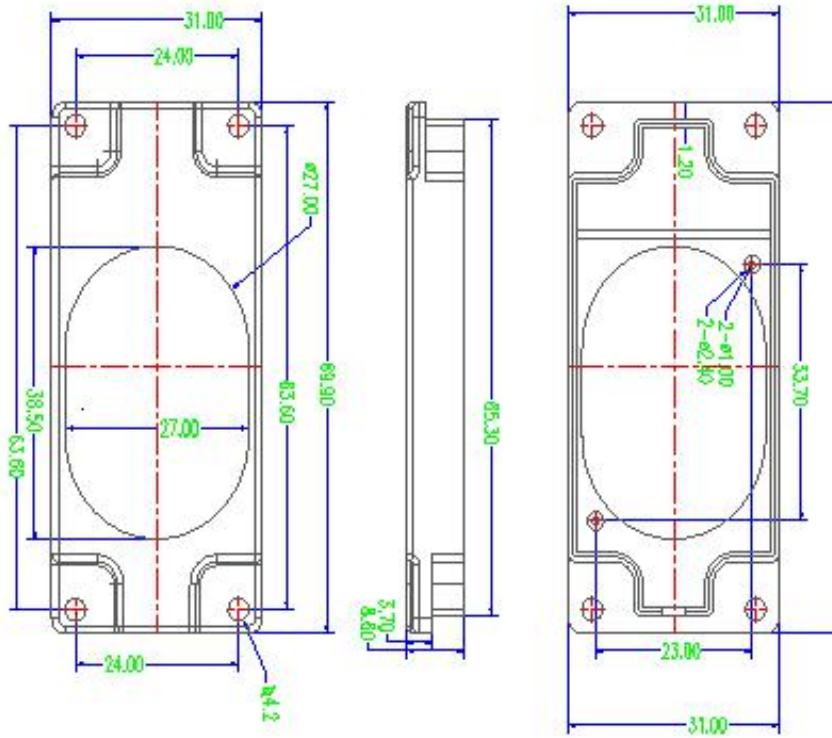
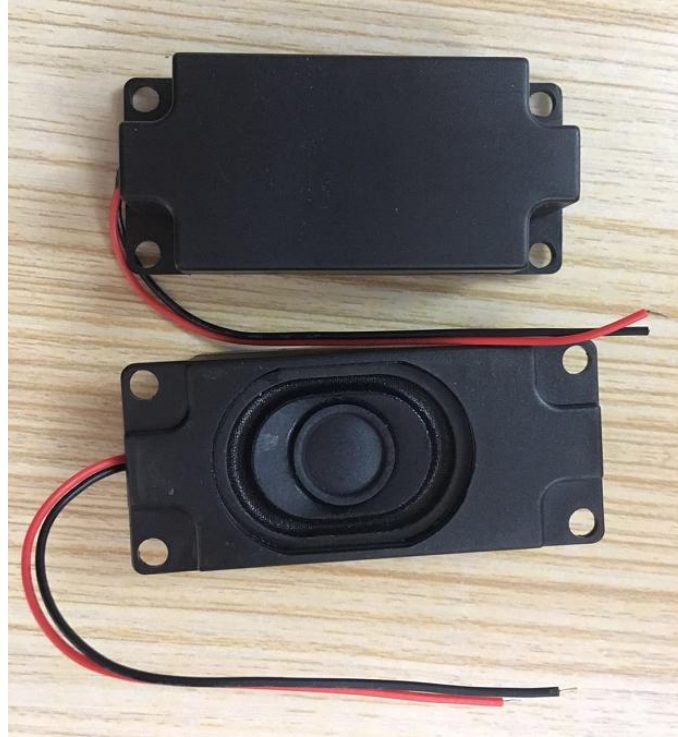

ITEM	DESCRIPTIONS	SPEC.	SUPPLIER	QTY	REMARK
1	Front foam ring	Adhesive		1	
2	Front cover	1Cr18Ni9		1	
3	Diaphragm	纸		1	
4	Voice coil	Self-bonding wire		1	
5	Inner pole shoe	08F,		1	
6	Magnet	Nd-Fe-B		1	
7	U YOKE	SPCE		1	
8	PCB	T0.3		1	
9	Lead wire			2	
10	Yoke assembly	PBT, black		1	
11	Insulator pad	Mylar		0	

Name

**MICRO SPEAKER**

Customer's Part No:

Our Part No: **GSPK4030PN-1M4R3W-L**

**SPEKER SPECIFICATION(P7/7)**

■ 包装明细/Packaging details

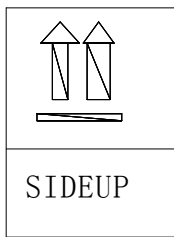
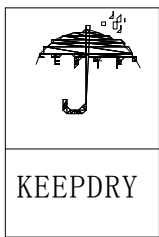
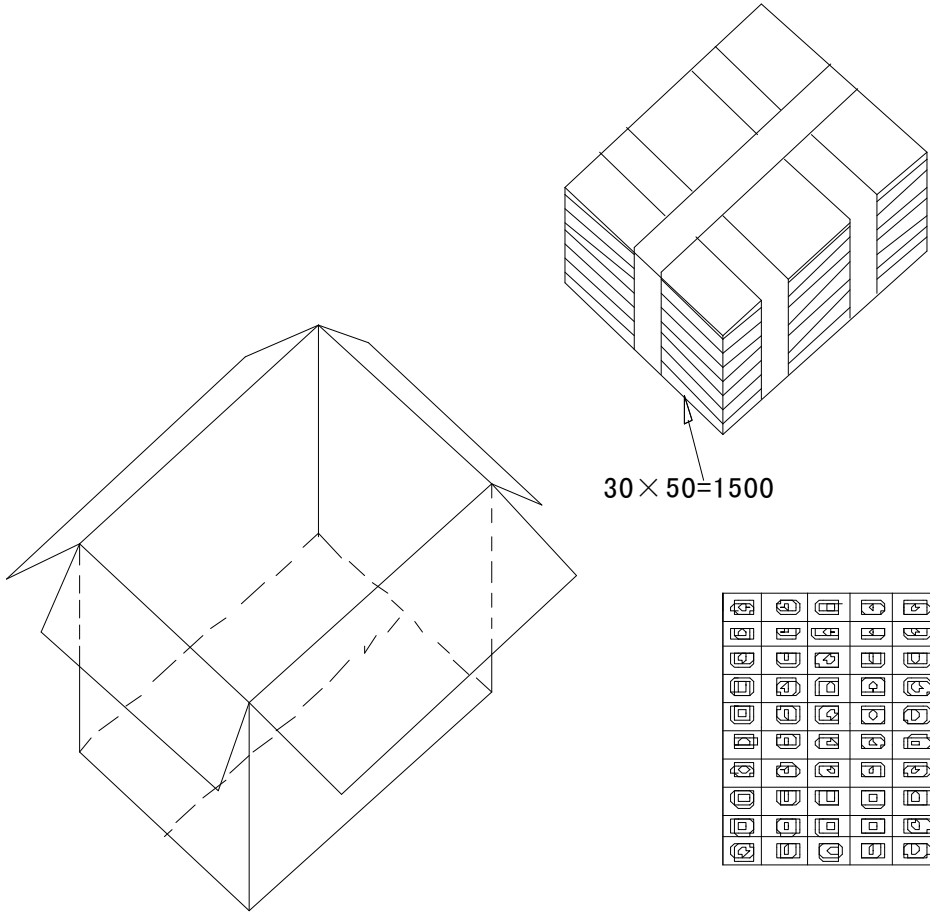

**DYNAMIC SPEAKERS**

TYPE:

QUANTITY: 1500PCS

GROSS WT: 5.5Kg

NET WT: 2.5Kg

CM: 43\*28\*47 cm

Name

**MICRO SPEAKER**

Customer's Part No:

Our Part No: **GSPK4030PN-1M4R3W-L**



## X-ON Electronics

Largest Supplier of Electrical and Electronic Components

*Click to view similar products for [Speakers & Transducers](#) category:*

*Click to view products by [INGHAI](#) manufacturer:*

Other Similar products are found below :

[AS02016MR-2-R](#) [PB-1220PE](#) [PB-2015PQ](#) [900-00001](#) [SMT-2240-TW-2-R](#) [SWFK-31736-000](#) [PT-2065FW](#) [PT-4175W](#) [AT-2830-TW-LW35-R](#) [ED-30761-000](#) [ED-31305-163](#) [CI-30120-A42](#) [TWFK-23991-000](#) [PB-0927PQ](#) [BF-7083-000](#) [AB6505B](#) [AS01708MR-SC-2-R](#) [AT-5030-TF-2-LW100-R](#) [AST-03008MR-R](#) [AS04008PS-4W-R](#) [AS01308MR-2-R](#) [AS01808AO-WP-R](#) [AS01508MR-6-R](#) [AS07108PO-R](#) [AS07708PS-2-WR-R](#) [AS07104PO-R](#) [SMS2020-08H4.5 LF](#) [BDT1717-08H6.5W56MLF](#) [SMS-2008MS-R](#) [AS04008PS-4W-WR-R](#) [AS06608PS-WR-R](#) [BLS50-1-08H18.2B-03 LF](#) [AS03008MR-R](#) [AS04008CO-2-R](#) [AS04008PR-WR-R](#) [ASE03008MR-LW150-R](#) [AS01808MR-LW152-R](#) [AS01808MR-R](#) [AS03608MR-4-R](#) [AS06608PS-R](#) [AS07708PS-2-R](#) [AS07108PO-3-R](#) [ASE06008MR-LW150-R](#) [ASE02008MR-LW150-R](#) [AST-1732MR-R](#) [SMS-1508MS-2-R](#) [AS05708MR-R](#) [AS07004PO-WR-R](#) [AS05008MR-R](#) [APS3008S-R](#)