

## INolux RGB CHIP LED Data Sheet IN-B101FCH

Official Product	IN Part No. IN-B101FCH	Customer Part No.		Data Sheet No.
Preliminary Product	*****	*****		IN-B101FCH
Specifications are subject to change without notice. Data and drawings herein are copyrighted.		April 10, 2015	Version of 1.0	Page 1/16

<b>DISCLAIMER</b> .....	<b>3</b>
<b>PRODUCT SPECIFICATIONS</b> .....	<b>4</b>
<b>ATTENTION: ELECTROSTATIC DISCHARGE (ESD) PROTECTION</b> .....	<b>5</b>
<b>LABEL SPECIFICATIONS</b> .....	<b>5</b>
<b>SPECIFICATIONS RANGE</b> .....	<b>6</b>
<b>PRODUCT FEATURES</b> .....	<b>8</b>
<b>ELECTRO-OPTICAL CHARACTERISTICS</b> .....	<b>8</b>
<b>PACKAGE OUTLINE DIMENSION &amp; RECOMMENDED SOLDERING PATTERN FOR SOLDERING</b> .....	<b>8</b>
<b>ABSOLUTE MAXIMUM RATINGS</b> .....	<b>9</b>
<b>CHARACTERISTICS OF IN-B101FCH</b> .....	<b>10</b>
<b>PACKAGING</b> .....	<b>11</b>
<b>TAPE DIMENSION</b> .....	<b>11</b>
<b>REEL DIMENSION</b> .....	<b>12</b>
<b>PRECAUTIONS</b> .....	<b>13</b>
<b>REVISION HISTORY</b> .....	<b>16</b>

Official Product	IN Part No. IN-B101FCH	Customer Part No.		Data Sheet No.
Preliminary Product	*****	*****		IN-B101FCH
Specifications are subject to change without notice. Data and drawings herein are copyrighted.		April 10, 2015	Version of 1.0	Page 2/16

## DISCLAIMER

INOLUX reserves the right to make changes without further notice to any products herein to improve reliability, function or design. INOLUX does not assume any liability arising out of the application or use of any product or circuit described herein; neither does it convey any license under its patent rights, nor the rights of others.

## LIFE SUPPORT POLICY

INOLUX's products are not authorized for use as critical components in life support devices or systems without the express written approval of the President of INOLUX or INOLUX CORPORATION. As used herein:

1. Life support devices or systems are devices or systems which, (a) are intended for surgical implant into the body, or (b) support or sustain life, and (c) whose failure to perform when properly used in accordance with instructions for use provided in the labeling, can be reasonably expected to result in a significant injury of the user.
  
2. A critical component in any component of a life support device or system whose failure to perform can be reasonably expected to cause the failure of the life support device or system, or to affect its safety or effectiveness.

Official Product	IN Part No. IN-B101FCH	Customer Part No.		Data Sheet No.
Preliminary Product	*****	*****		IN-B101FCH
Specifications are subject to change without notice. Data and drawings herein are copyrighted.		April 10, 2015	Version of 1.0	Page 3/16

**Product Specifications**

	Specification	Material	Quantity
Iv	R: 58 mcd typical G: 85 mcd typical B: 17 mcd typical R@10mA; G/B@5mA / Ta= 25°C; Tolerance ±10%		
λD	R: 621 nm typical G: 529 nm typical B: 470 nm typical R@10mA; G/B@5mA / Ta= 25° C; Tolerance ± 0.5nm		
Vf	R: 2.4 V maximum G: 3.4 V maximum B: 3.4 V maximum R@10mA; G/B@5mA / Ta= 25o C; Tolerance ± 0.05V		
Ir	<100uA@ VR=5V		
Resin	Dark	Epoxy Resin	
Carrier tape	EIA 481-1A specs	Conductive black tape	24000 pcs/reel
Reel	EIA 481-1A specs	Conductive black	
Label	HT standard	Paper	
Packing bag	250x230mm	Aluminum laminated bag/ no-zipper	One reel per bag
Carton	HT standard	Paper	Non-specified

Official Product	IN Part No. IN-B101FCH	Customer Part No.		Data Sheet No.
Preliminary Product	*****	*****		IN-B101FCH
Specifications are subject to change without notice. Data and drawings herein are copyrighted.		April 10, 2015	Version of 1.0	Page 4/16

**Others:**

Each immediate box consists of 5 reels. The 5 reels may not necessarily have the same lot number or the same bin combinations of  $I_v$ ,  $\lambda_D$  and  $V_f$ . Each reel has a label identifying its specification; the immediate box consists of a product label as well.

**ATTENTION: Electrostatic Discharge (ESD) protection**



The symbol to the left denotes that ESD precaution is needed. ESD protection for GaP and AlGaAs based chips is necessary even though they are relatively safe in the presence of low static-electric discharge. Parts built with AlInGaP, GaN, or/and InGaN based chips are **STATIC SENSITIVE devices**. ESD precaution must be taken during design and assembly.

If manual work or processing is needed, please ensure the device is adequately protected from ESD during the process.

**Label Specifications**

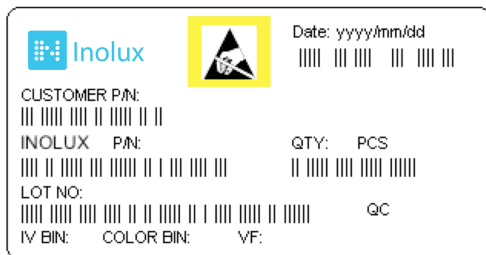

**INolux P/N:**

I N - B 1 0 1 F C H - X X X X

Product	Package	Color	Customer Code
IN: INolux Technologies	B101: 1.0 (L) x 1.0 (W) x 0.65 (H) mm	FCH: RGB	XXXX: Customer Specific Code

Official Product	IN Part No. IN-B101FCH	Customer Part No.		Data Sheet No.
Preliminary Product	*****	*****		IN-B101FCH
Specifications are subject to change without notice. Data and drawings herein are copyrighted.		April 10, 2015	Version of 1.0	Page 5/16

**Lot No.:**

1	2	3	4	5	6	7	8	9	10
1	7	N	E	4	1	L	N	1	1
Code 1 2		Code 3	Code 4	Code 5	Code 6	Code 7	Code 8	Code 9	Code 10
Internal Tracing Code		Mixing Lot No.	Mfg.Year	Mfg.Month	Consecutive number		Special code		
			2010-A 2011-B 2012-C 2013-D 2014-E .	1:Jan 2:Feb ..... A:Oct B:Nov C:Dec	01~ZZ		000~ZZZ		

**Specifications Range**
**■Luminous Intensity (Iv) Bin :**

B101FCH								
IV								
Red			Green			Blue		
FK3	43.7	52.5	FM1	63	75.6	FF2	13	15.6
FL1	47.2	56.7	FM2	68.5	82.5	FF3	14.5	17.5
FL2	52.5	63	FM3	75.6	91	FG1	15.6	18.8
FL3	56.7	68.5	FN1	82.5	99	FG2	17.5	21
FM1	63	75.6	FN2	91	110	FG3	18.8	22.6
FM2	68.5	82.5	FN3	99	119	FH1	21	25.2

Note: It maintains a tolerance of  $\pm 10\%$  on luminous intensity

Official Product	IN Part No. IN-B101FCH	Customer Part No.		Data Sheet No.
Preliminary Product	*****	*****		IN-B101FCH
Specifications are subject to change without notice. Data and drawings herein are copyrighted.		April 10, 2015	Version of 1.0	Page 6/16

**■Color Bin:**

B101FCH								
WD								
Red			Green			Blue		
R1	616	620	G1	523	526	B1	464	467
R2	620	624	G2	526	529	B2	467	470
R3	624	628	G3	529	532	B3	470	473
R4	628	632	G4	532	535	B4	473	476
			G5	535	538	B5	476	479

Note: It maintains a tolerance of  $\pm 0.5\text{nm}$  on color

**■Forward Voltage (Vf) Bin:**

B101FCH								
Vf								
Red			Green			Blue		
-	1.6	2.4	-	2.4	3.4	-	2.4	3.4

Note: It maintains a tolerance of  $\pm 0.05\text{V}$  on forward voltage measurements

Official Product	IN Part No. IN-B101FCH	Customer Part No.		Data Sheet No.
Preliminary Product	*****	*****		IN-B101FCH
Specifications are subject to change without notice. Data and drawings herein are copyrighted.		April 10, 2015	Version of 1.0	Page 7/16

**Product Features**
**Electro-Optical Characteristics**

 (I<sub>F</sub> @ 10mA, T<sub>a</sub> 25 °C)

Series	Emitting Color	VF(V)		Wavelength λ(nm)			IV(mcd)	2θ1/2
		Typ.	Max.	λ <sub>D</sub>	λ <sub>P</sub>	Δλ	Typical	
IN-B101FCH	Red	2.0	2.4	621	629	16	58	140
	Green	2.8	3.4	531	520	32	85	140
	Blue	3.0	3.4	470	480	22	17	140

**Package Outline Dimension & Recommended Soldering Pattern for Soldering**

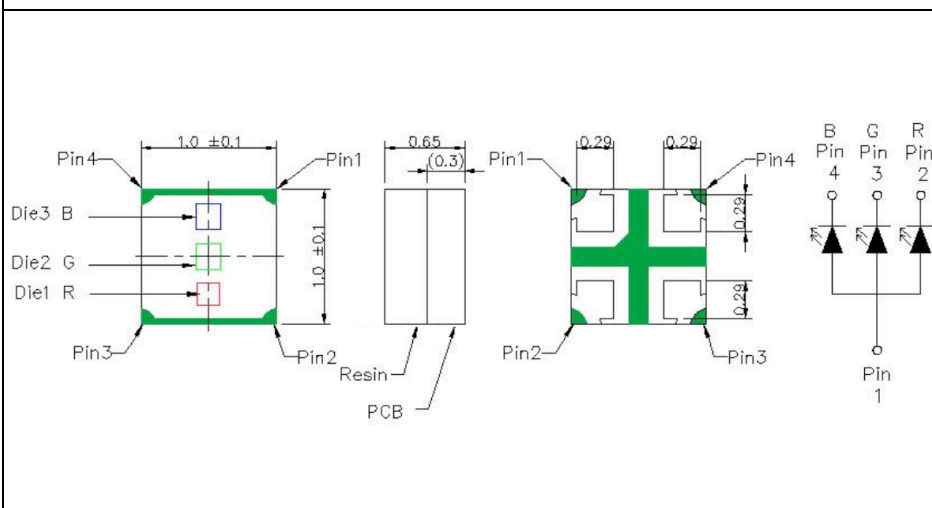
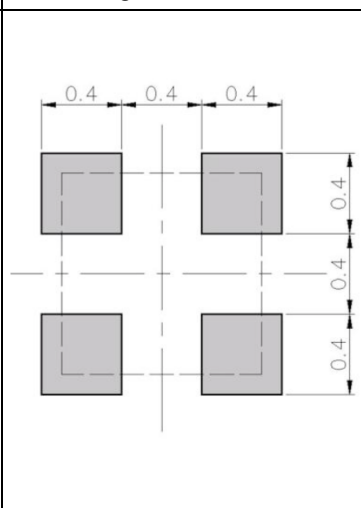
Outline Dim.	Soldering Pattern
 <p>                     The diagram shows the package outline with dimensions: Pin 4 to Pin 1 is 1.0 ±0.1 mm, Pin 1 to Pin 2 is 0.65 mm (0.3 mm offset), and Pin 1 to Pin 3 is 1.0 ±0.1 mm. Die sizes are 0.29 mm. A PCB resin layer is shown. The soldering pattern shows four pads, each 0.4 mm wide and 0.4 mm high, with 0.4 mm spacing between them. Pin 1 is the common ground.                 </p>	 <p>                     The soldering pattern shows four square pads, each 0.4 mm wide and 0.4 mm high, arranged in a 2x2 grid with 0.4 mm spacing between them. Pin 1 is the common ground.                 </p>
Soldering terminals may shift in the x, y direction. Unit: mm Tolerance: +/-0.1mm	

Official Product	IN Part No. IN-B101FCH	Customer Part No.	Data Sheet No.
Preliminary Product	*****	*****	IN-B101FCH
Specifications are subject to change without notice. Data and drawings herein are copyrighted.	April 10, 2015	Version of 1.0	Page 8/16



<b>Absolute Maximum Ratings</b>
---------------------------------

(T<sub>a</sub> 25 °C)

Series	P <sub>d</sub> (mW)	I <sub>F</sub> (mA)	I <sub>FP</sub> (mA)	I <sub>R</sub> (uA)	T <sub>OP</sub> (°C)
Color	Power Dissipation	Forward Current	Pulse Forward Current	Operating Temperature	Storage Temperature
Red	150	10	60	-30~+80	-40~+85
Blue	150	5	60	-30~+80	-40~+85
Green	150	5	60	-30~+80	-40~+85

\*\* Condition for I<sub>FP</sub> is pulse of 1/10 duty and 0.1msec width

Remarks: This product should be operated in forward bias. If a reverse voltage is continuously applied to the product, such operation can cause migration resulting in LED damage.

Official Product	IN Part No. IN-B101FCH	Customer Part No.		Data Sheet No.
Preliminary Product	*****	*****		IN-B101FCH
Specifications are subject to change without notice. Data and drawings herein are copyrighted.		April 10, 2015	Version of 1.0	Page 9/16

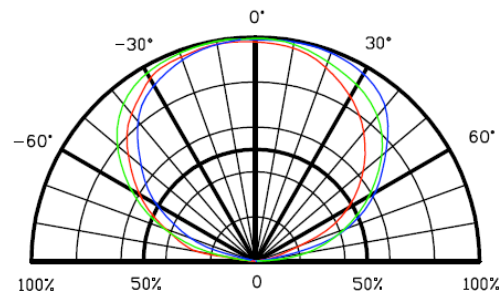
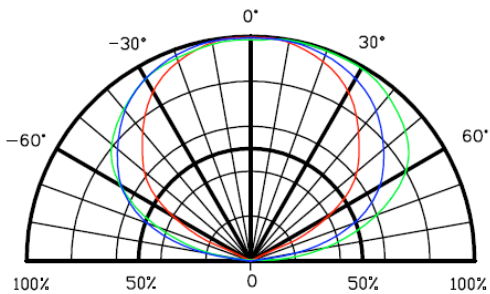
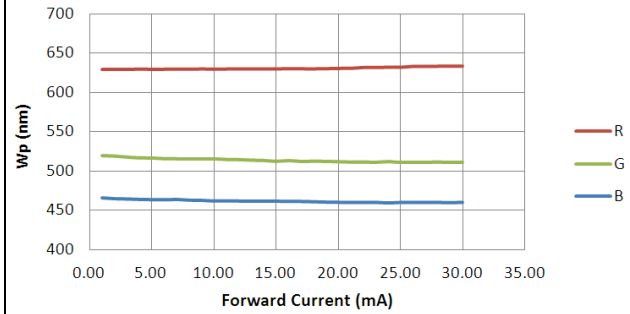
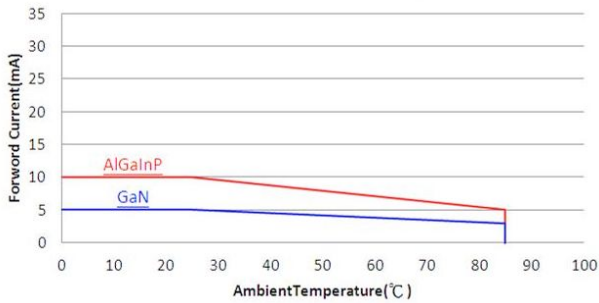
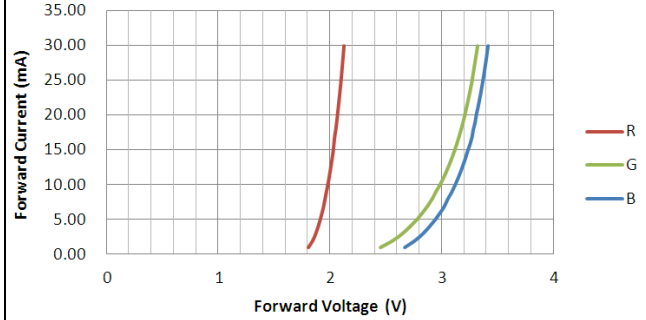
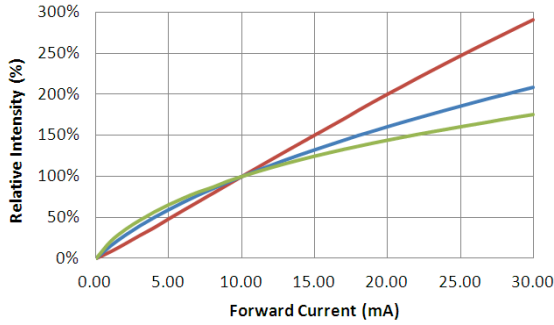
**Characteristics of IN-B101FCH**

Official Product	IN Part No. IN-B101FCH	Customer Part No.	Data Sheet No.
Preliminary Product	*****	*****	IN-B101FCH
Specifications are subject to change without notice. Data and drawings herein are copyrighted.		April 10, 2015	Version of 1.0
			Page 10/16

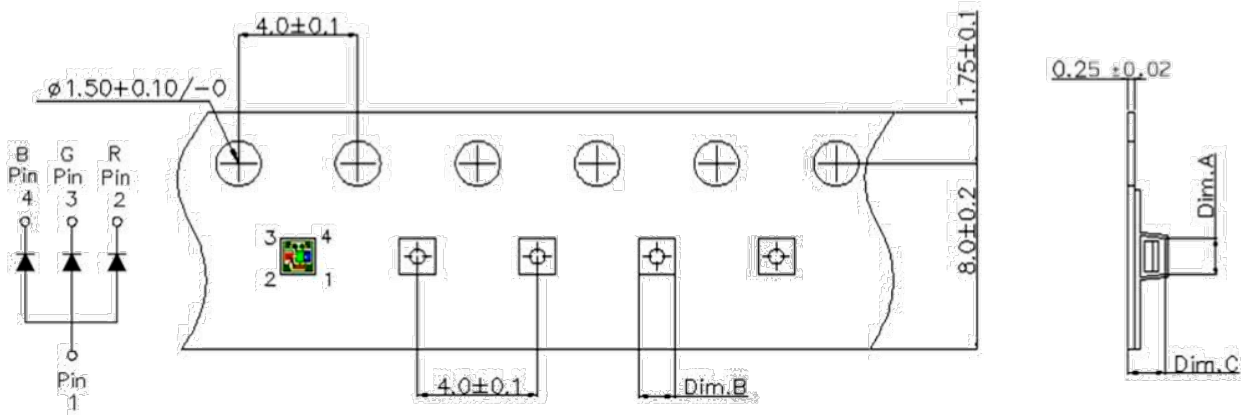
**Packaging**
**Tape Dimension**

Dim. A	Dim. B	Dim. C	Q'ty/Reel
1.22±0.05	1.22±0.05	0.78±0.05	24K

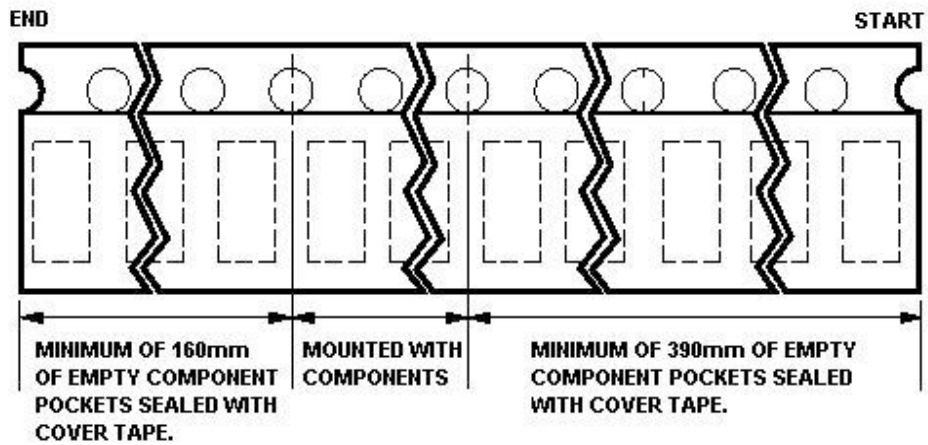

Unit: mm

Official Product	IN Part No. IN-B101FCH	Customer Part No.		Data Sheet No.
Preliminary Product	*****	*****		IN-B101FCH
Specifications are subject to change without notice. Data and drawings herein are copyrighted.		April 10, 2015	Version of 1.0	Page 11/16

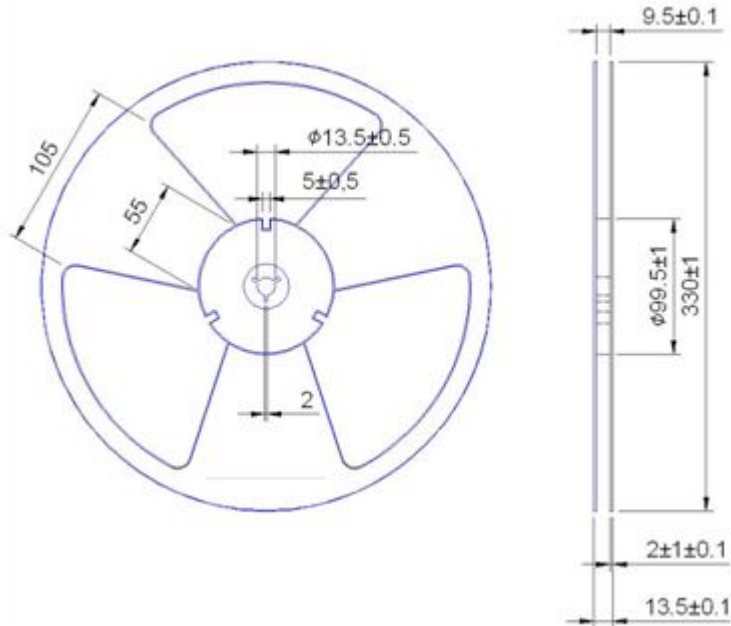
**Reel Dimension**

Unit: mm Tolerance: +/-0.15mm

Official Product	IN Part No. IN-B101FCH	Customer Part No.		Data Sheet No.
Preliminary Product	*****	*****		IN-B101FCH
Specifications are subject to change without notice. Data and drawings herein are copyrighted.		April 10, 2015	Version of 1.0	Page 12/16

### Precautions

Please read the following notes before using the product:

#### 1. Over-current-proof

Customer must apply resistors for protection; otherwise slight voltage shift will cause big current change (Burn out will happen).

#### 2. Storage

2.1 Do not open moisture proof bag before the products are ready to use.

2.2 Before opening the package, the LEDs should be kept at 30°C or less and 80%RH or less.

2.3 The LEDs should be used within a year.

2.4 After opening the package, the LEDs should be kept at 30°C or less and 60%RH or less.

2.5 The LEDs should be used within 168 hours (7 days) after opening the package.

2.6 If the moisture adsorbent material has fabled away or the LEDs have exceeded the storage time, baking treatment should be performed using the following conditions. Baking treatment: 60±5°C for 24 hours.

Official Product	IN Part No. IN-B101FCH	Customer Part No.		Data Sheet No.
Preliminary Product	*****	*****		IN-B101FCH
Specifications are subject to change without notice. Data and drawings herein are copyrighted.		April 10, 2015	Version of 1.0	Page 13/16

### 3. Soldering Condition

When soldering, for Lamp without stopper type and must be leave a minimum of 3mm clearance from the base of the lens to the soldering point.

To avoided the Epoxy climb up on lead frame and was impact to non-soldering problem, dipping the lens into the solder must be avoided.

Do not apply any external stress to the lead frame during soldering while the LED is at high temperature.

Recommended soldering conditions:

Soldering Iron		Lead Free Wave Soldering	
Temperature	300°C Max.	Pre-heat	150°C Max.
Soldering Time	3 sec. Max. (One time only)	Pre-heat Time	120 sec. Max.
		Solder Wave	260°C Max.
		Soldering Time	10 sec. Max.

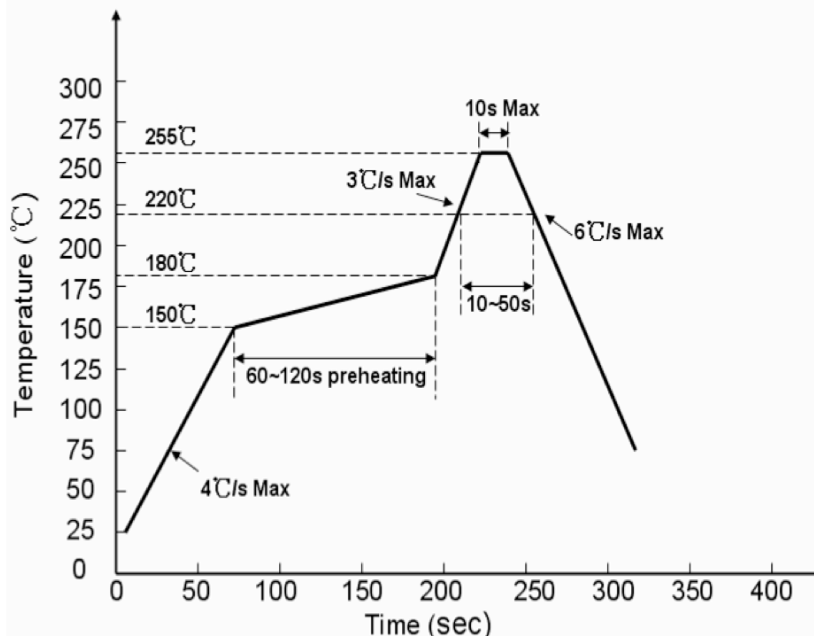

Note: Excessive soldering temperature and / or time might result in deformation of the LED lens or catastrophic failure of the LED.

Official Product	IN Part No. IN-B101FCH	Customer Part No.	Data Sheet No.
Preliminary Product	*****	*****	IN-B101FCH
Specifications are subject to change without notice. Data and drawings herein are copyrighted.		April 10, 2015	Version of 1.0
			Page 14/16

#### 4. Soldering Iron

Each terminal is to go to the tip of soldering iron temperature less than 260°C for 5 seconds within once in less than the soldering iron capacity 25W. Leave two seconds and more intervals, and do soldering of each terminal. Be careful because the damage of the product is often started at the time of the hand solder.

#### 5. Repairing

Repair should not be done after the LEDs have been soldered. When repairing is unavoidable, a double-head soldering iron should be used (as below figure). It should be confirmed beforehand whether the characteristics of the LEDs will or will not be damaged by repairing.

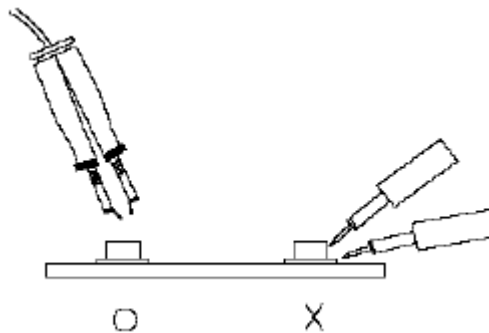

#### 6. Caution in ESD

Static Electricity and surge damages the LED. It is recommended to use a wristband or anti-electrostatic glove when handling the LED. All devices, equipment and machinery must be properly grounded.

Official Product	IN Part No. IN-B101FCH	Customer Part No.		Data Sheet No.
Preliminary Product	*****	*****		IN-B101FCH
Specifications are subject to change without notice. Data and drawings herein are copyrighted.		April 10, 2015	Version of 1.0	Page 15/16

**Revision History**

Changes since last revision	Page	Version No.	Revision Date
Initial release	-	1.0	04-10-2015

Official Product	IN Part No. IN-B101FCH	Customer Part No.		Data Sheet No.
Preliminary Product	*****	*****		IN-B101FCH
Specifications are subject to change without notice. Data and drawings herein are copyrighted.		April 10, 2015	Version of 1.0	Page 16/16



## X-ON Electronics

Largest Supplier of Electrical and Electronic Components

*Click to view similar products for [Standard LEDs - SMD category](#):*

*Click to view products by [Inolux manufacturer](#):*

Other Similar products are found below :

[LTST-C190KYKT](#) [LTST-C19GD2WT](#) [LTST-N683GBEW](#) [LTW-170ZDC](#) [LTW-M140SZS40](#) [LTW-M140ZVS](#) [598-8110-100F](#) [598-8170-100F](#) [598-8610-202F](#) [67-22VRVGC/TR8](#) [AAAF5060QBFSEEZGS](#) [HLMA-QG00-S0021](#) [HLMP-6305-L0011](#) [ALMD-LB36-SV002](#) [APT1608QGW](#) [15-21UYC/S530-A3/TR8](#) [EAST2012YA0](#) [EASV1803BA0](#) [LG M67K-H1J2-24-0-2-R18-Z](#) [LS A676-P2S1-1](#) [SML310BATT86](#) [SML-512VWT86A](#) [SML-LX0606SISUGC/A](#) [SML-LXL1307SRC-TR](#) [SML-LXR851SIUPGUBC](#) [LT1ED53A](#) [FAT801-S](#) [AM27ZGC03](#) [APB3025SGNC](#) [APFA3010SURKCGKQBDC](#) [APHK1608VGCA](#) [APT2012QGW](#) [LTST-C250KGKT](#) [LTW-010DCG](#) [LTW-020ZDCG](#) [LTW-21TS5](#) [LTW-220DS5](#) [LY L29K-H1J2-26](#) [JANTXM19500/521-02](#) [UYGT801-S](#) [42-21UYC/S530-A3/TR8](#) [LO T67F-V1AB-24-1](#) [YGFR411-H](#) [598-8330-117F](#) [SML-LX0402IC-TR](#) [CMDA20AYAA7D1S](#) [CMDA16AYDR7A1X](#) [598-8040-100F](#) [598-8070-100F](#) [598-8140-100F](#)