

Features

- 3.6*3.1*3.1 mm SMD LED
- High Brightness
- InGaN Technology
- Viewing Angle 60°
- High reliability
- MSL Level 3
- Water-Resistant(IPX7)

Applications

- Consumer Electronics
- Traffic lights
- Automobile After Market
- Industrial Equipment

Description

The IN-P36BTEUW is a popular low profile 3631 package with versatile design capabilities. It is a PLCC type silicone style LED which can be used in various applications.

Recommended Solder Pattern

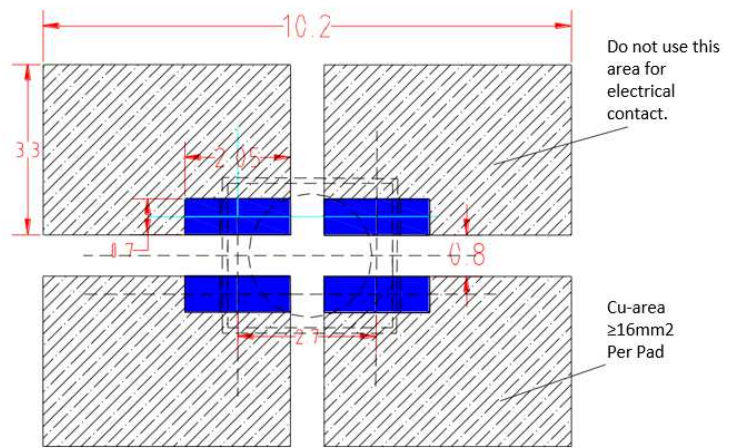

Figure 1. IN-P36BTEUW Solder Pattern

Package Dimensions in mm

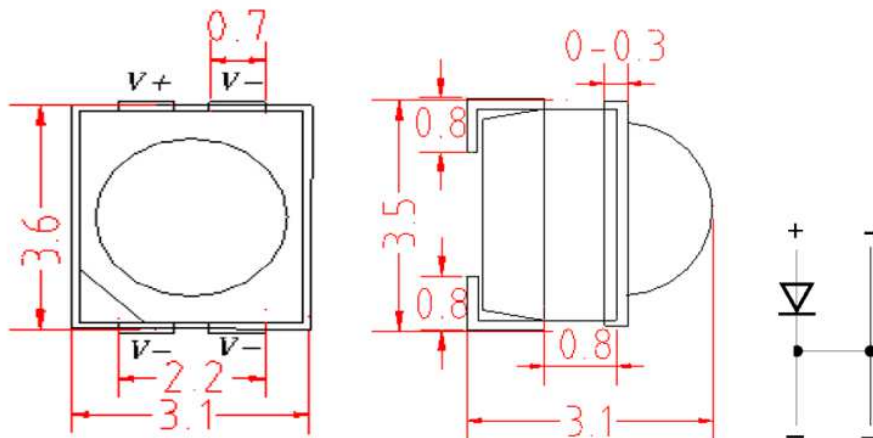

Figure 2. IN-P36BTEUW Package Dimensions

*Notice: Tolerance of measurement of Dimension: ±0.2mm

Absolute Maximum Rating at 25°C

Product	Emission Color	P _d (mW)	I _{FP} * (mA)	T _j (°C)	V _R (V)	T _{OP} (°C)	T _{ST} (°C)
IN-P36BTEUW	White	97	80	125	5	-40°C~+100°C	-40°C~+100°C

*Condition for I_{FP} is pulse of 1/10 duty and 0.1msec width

ESD Precaution

ATTENTION: Electrostatic Discharge (ESD) protection



The symbol above denotes that ESD precaution is needed. ESD protection for GaP and AlGaAs based chips is necessary even though they are relatively safe in the presence of low static-electric discharge. Parts built with AlInGaP, GaN, or/and InGaN based chips are STATIC SENSITIVE devices. ESD precaution must be taken during design and assembly. If manual work or processing is needed, please ensure the device is adequately protected from ESD during the process.

Please be advised that normal static precautions should be taken in the handling and assembly of this device to prevent damage or degradation which may be induced by electrostatic discharge (ESD).

Electrical Characteristics T_A = 25°C

Product	Emission Color	I _F (mA)	V _F (V)	Luminous Intensity(mcd)	Color Rank	Viewing Angle	I _r (V _r = 5V)	ESD Sensitivity(V)
			Typ.	Typ.	K	2θ 1/2	μA	HBM
IN-P36BTEUW	White	30	3.0	5500	2700~7000	60	10	1000

*Notes: Performance guaranteed only under conditions listed in above tables.

Luminous Intensity Rank Limits (IF =30mA)

Bin Code	32	33	34	35
Flux Rank(mcd)	3000-3900	3900-5100	5100-6600	6600-8600

*Notice: Tolerance of measurement of Luminous Intensity: $\pm 12\%$

Forward Voltage Rank Limits (IF =30mA)

Bin Code	Min	Max	Unit
V28	2.8	2.9	V
V29	2.9	3.0	
V30	3.0	3.1	
V31	3.1	3.2	
V32	3.2	3.3	
V33	3.3	3.4	

*Notice: Tolerance of measurement of Forward Voltage: $\pm 0.1V$

Color Rank Limits (IF =30mA)

Warm White

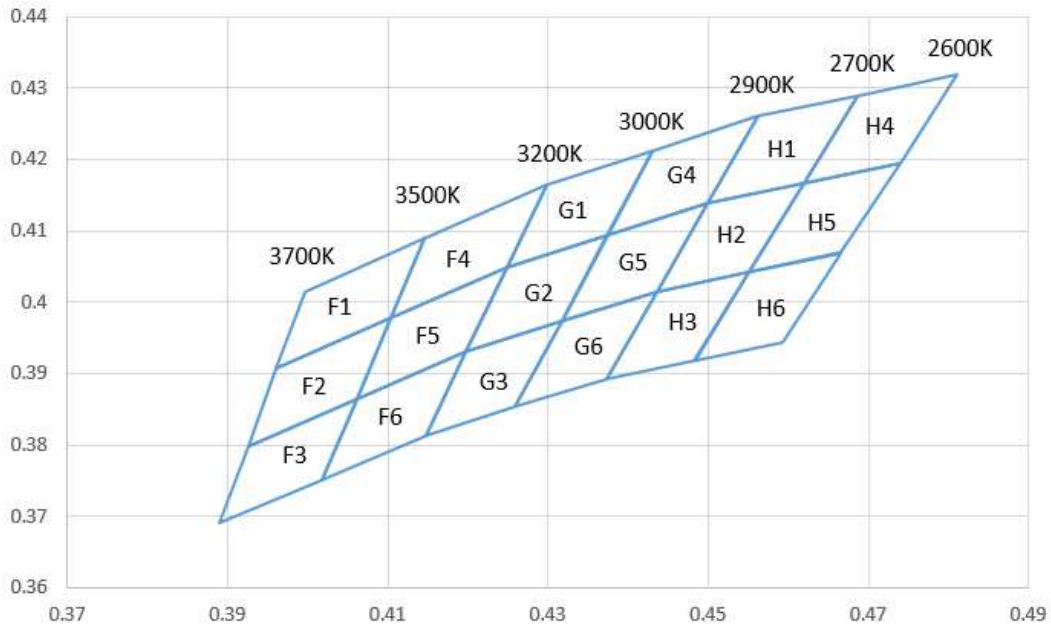

Rank F Color Temperature:3500~3700K						Rank F Color Temperature:3200~3500K					
F1		F2		F3		F4		F5		F6	
CIE X	CIE Y	CIE X	CIE Y	CIE X	CIE Y	CIE X	CIE Y	CIE X	CIE Y	CIE X	CIE Y
0.3996	0.4015	0.396	0.3907	0.3925	0.3798	0.4146	0.4089	0.4104	0.3978	0.4062	0.3865
0.396	0.3907	0.3925	0.3798	0.3889	0.369	0.4104	0.3978	0.4062	0.3865	0.4017	0.3751
0.4104	0.3978	0.4062	0.3865	0.4017	0.3751	0.4248	0.4048	0.4198	0.3931	0.4147	0.3814
0.4146	0.4089	0.4104	0.3978	0.4062	0.3865	0.4299	0.4165	0.4248	0.4048	0.4198	0.3931
0.3996	0.4015	0.396	0.3907	0.3925	0.3798	0.4146	0.4089	0.4104	0.3978	0.4062	0.3865
Rank G Color Temperature:3000~3200K						Rank G Color Temperature:2900~3000K					
G1		G2		G3		G4		G5		G6	
CIE X	CIE Y	CIE X	CIE Y	CIE X	CIE Y	CIE X	CIE Y	CIE X	CIE Y	CIE X	CIE Y
0.4299	0.4165	0.4248	0.4048	0.4198	0.3931	0.443	0.4212	0.4374	0.4093	0.4317	0.3973
0.4248	0.4048	0.4198	0.3931	0.4147	0.3814	0.4374	0.4093	0.4317	0.3973	0.4259	0.3853
0.4374	0.4093	0.4317	0.3973	0.4259	0.3853	0.4499	0.4138	0.4436	0.4015	0.4373	0.3893
0.443	0.4212	0.4374	0.4093	0.4317	0.3973	0.4562	0.426	0.4499	0.4138	0.4436	0.4015
0.4299	0.4165	0.4248	0.4048	0.4198	0.3931	0.443	0.4212	0.4374	0.4093	0.4317	0.3973
Rank H Color Temperature:2700~2900K						Rank H Color Temperature:2600~2700K					
H1		H2		H3		H4		H5		H6	
CIE X	CIE Y	CIE X	CIE Y	CIE X	CIE Y	CIE X	CIE Y	CIE X	CIE Y	CIE X	CIE Y
0.4562	0.426	0.4499	0.4138	0.4436	0.4015	0.4687	0.4289	0.462	0.4166	0.4551	0.4042
0.4499	0.4138	0.4436	0.4015	0.4373	0.3893	0.462	0.4166	0.4551	0.4042	0.4483	0.3919
0.462	0.4166	0.4551	0.4042	0.4483	0.3919	0.474	0.4194	0.4666	0.4069	0.4593	0.3944
0.4687	0.4289	0.462	0.4166	0.4551	0.4042	0.481	0.4319	0.474	0.4194	0.4666	0.4069
0.4562	0.426	0.4499	0.4138	0.4436	0.4015	0.4687	0.4289	0.462	0.4166	0.4551	0.4042

*Notice: Tolerance of measurement of Color Coordinates : ± 0.01

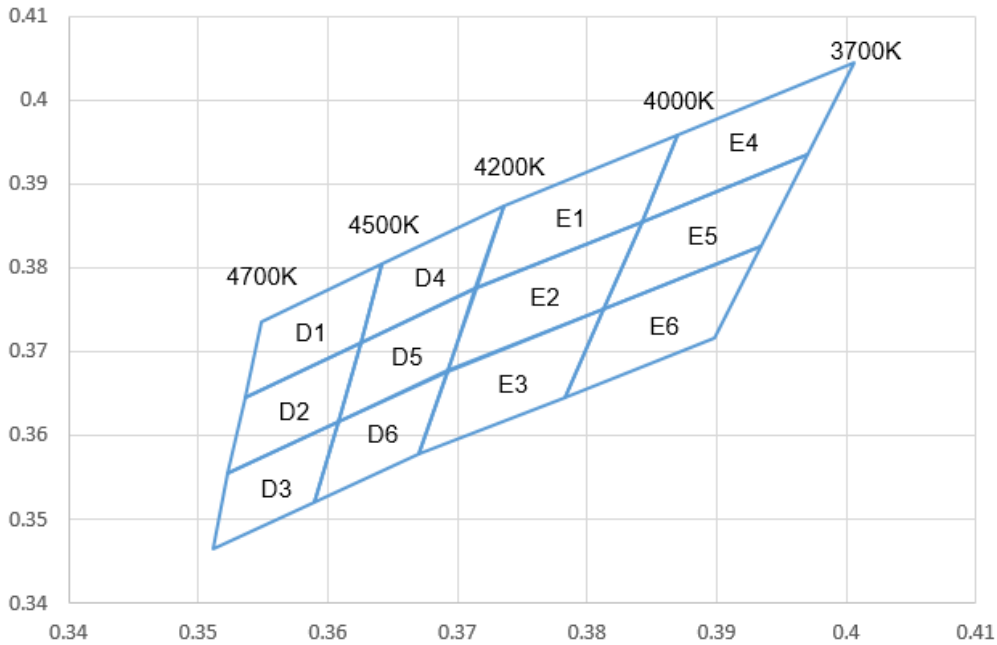
Neutral White

Rank D Color Temperature:4500~4700K						Rank E Color Temperature:4000~4200K					
D1		D2		D3		E1		E2		E3	
CIE X	CIE Y	CIE X	CIE Y	CIE X	CIE Y	CIE X	CIE Y	CIE X	CIE Y	CIE X	CIE Y
0.3548	0.3736	0.3536	0.3646	0.3523	0.3555	0.3736	0.3874	0.3714	0.3775	0.3692	0.3677
0.3536	0.3646	0.3523	0.3555	0.3511	0.3465	0.3714	0.3775	0.3692	0.3677	0.367	0.3578
0.3625	0.3711	0.3608	0.3616	0.359	0.3521	0.3842	0.3855	0.3813	0.3751	0.3783	0.3646
0.3641	0.3804	0.3625	0.3711	0.3608	0.3616	0.3869	0.3958	0.3842	0.3855	0.3813	0.3751
0.3548	0.3736	0.3536	0.3646	0.3523	0.3555	0.3736	0.3874	0.3714	0.3775	0.3692	0.3677
Rank D Color Temperature:4200~4500K						Rank E Color Temperature:3700~4000K					
D4		D5		D6		E4		E5		E6	
CIE X	CIE Y	CIE X	CIE Y	CIE X	CIE Y	CIE X	CIE Y	CIE X	CIE Y	CIE X	CIE Y
0.3641	0.3804	0.3625	0.3711	0.3608	0.3616	0.3869	0.3958	0.3842	0.3855	0.3813	0.3751
0.3625	0.3711	0.3608	0.3616	0.359	0.3521	0.3842	0.3855	0.3813	0.3751	0.3783	0.3646
0.3714	0.3775	0.3692	0.3677	0.367	0.3578	0.397	0.3935	0.3934	0.3825	0.3898	0.3716
0.3736	0.3874	0.3714	0.3775	0.3692	0.3677	0.4006	0.4044	0.397	0.3935	0.3934	0.3825
0.3641	0.3804	0.3625	0.3711	0.3608	0.3616	0.3869	0.3958	0.3842	0.3855	0.3813	0.3751

*Notice: Tolerance of measurement of Color Coordinates : ± 0.01

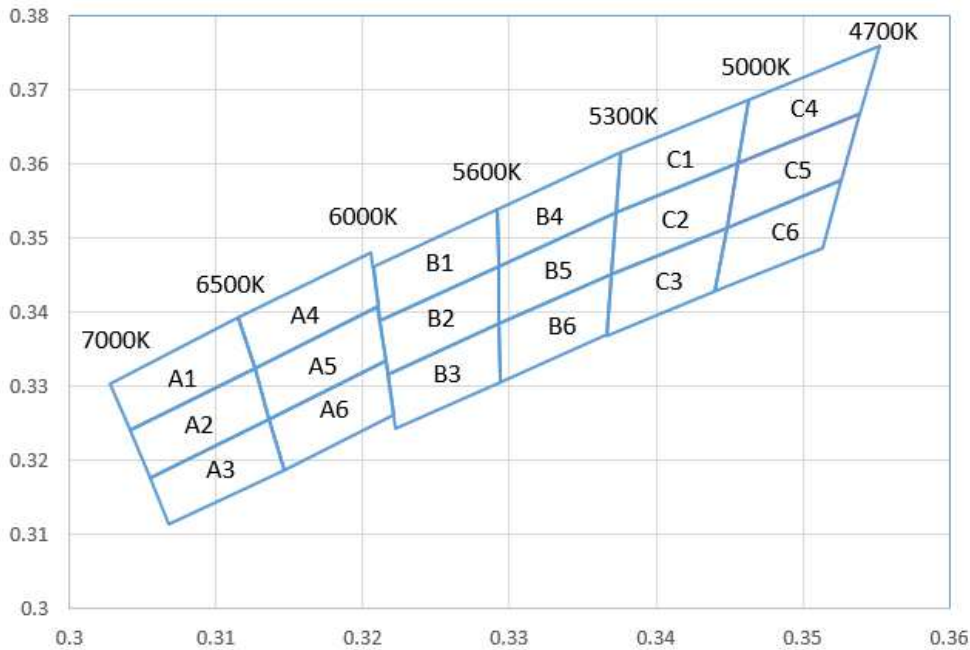
Cool White

Rank A Color Temperature:6500~7000K						Rank A Color Temperature:6000~6500K					
A1		A2		A3		A4		A5		A6	
CIE X	CIE Y	CIE X	CIE Y	CIE X	CIE Y	CIE X	CIE Y	CIE X	CIE Y	CIE X	CIE Y
0.3028	0.3304	0.3041	0.324	0.3055	0.3177	0.3115	0.3393	0.3126	0.3324	0.3136	0.3256
0.3041	0.324	0.3055	0.3177	0.3068	0.3113	0.3126	0.3324	0.3136	0.3256	0.3146	0.3187
0.3126	0.3324	0.3136	0.3256	0.3146	0.3187	0.321	0.3408	0.3216	0.3334	0.3221	0.3261
0.3115	0.3393	0.3126	0.3324	0.3136	0.3256	0.3205	0.3481	0.321	0.3408	0.3216	0.3334
0.3028	0.3304	0.3041	0.324	0.3055	0.3177	0.3115	0.3393	0.3126	0.3324	0.3136	0.3256
Rank B Color Temperature:5600~6000K						Rank B Color Temperature:5300~5600K					
B1		B2		B3		B4		B5		B6	
CIE X	CIE Y	CIE X	CIE Y	CIE X	CIE Y	CIE X	CIE Y	CIE X	CIE Y	CIE X	CIE Y
0.3207	0.3462	0.3212	0.3389	0.3217	0.3316	0.3292	0.3539	0.3293	0.3461	0.3293	0.3384
0.3212	0.3389	0.3217	0.3316	0.3222	0.3243	0.3293	0.3461	0.3293	0.3384	0.3294	0.3306
0.3293	0.3461	0.3293	0.3384	0.3294	0.3306	0.3373	0.3534	0.3369	0.3451	0.3366	0.3369
0.3292	0.3539	0.3293	0.3461	0.3293	0.3384	0.3376	0.3616	0.3373	0.3534	0.3369	0.3451
0.3207	0.3462	0.3212	0.3389	0.3217	0.3316	0.3292	0.3539	0.3293	0.3461	0.3293	0.3384
Rank C Color Temperature:5000~5300K						Rank C Color Temperature:4700~5000K					
C1		C2		C3		C4		C5		C6	
CIE X	CIE Y	CIE X	CIE Y	CIE X	CIE Y	CIE X	CIE Y	CIE X	CIE Y	CIE X	CIE Y
0.3376	0.3616	0.3373	0.3534	0.3369	0.3451	0.3463	0.3687	0.3456	0.3601	0.3448	0.3514
0.3373	0.3534	0.3369	0.3451	0.3366	0.3369	0.3456	0.3601	0.3448	0.3514	0.344	0.3428
0.3456	0.3601	0.3448	0.3514	0.344	0.3428	0.3539	0.3669	0.3526	0.3578	0.3514	0.3487
0.3463	0.3687	0.3456	0.3601	0.3448	0.3514	0.3552	0.376	0.3539	0.3669	0.3526	0.3578
0.3376	0.3616	0.3373	0.3534	0.3369	0.3451	0.3463	0.3687	0.3456	0.3601	0.3448	0.3514

*Notice: Tolerance of measurement of Color Coordinates : ± 0.01

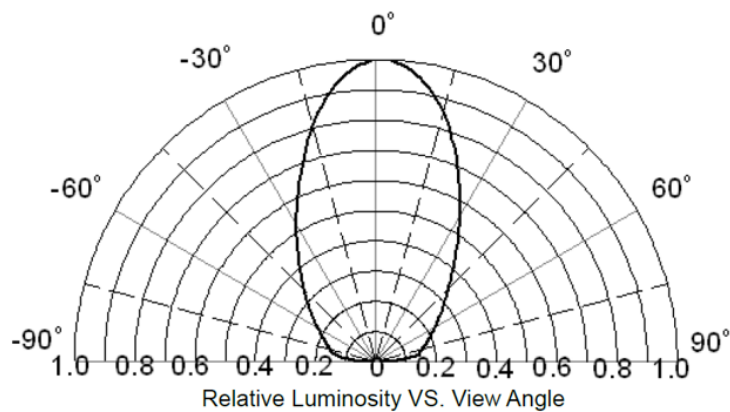
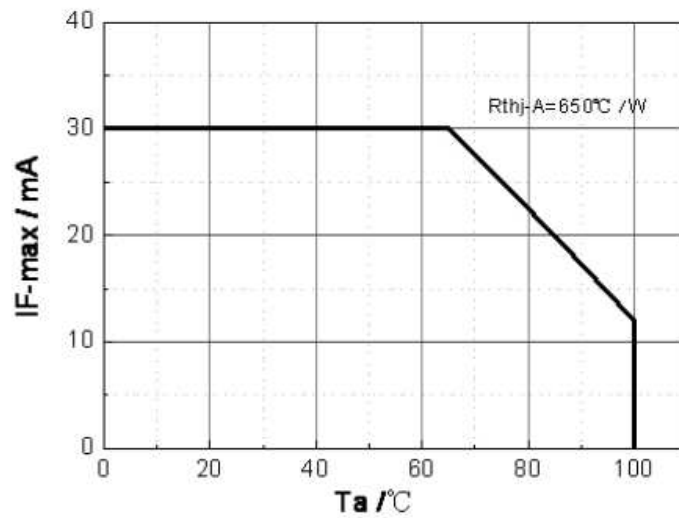
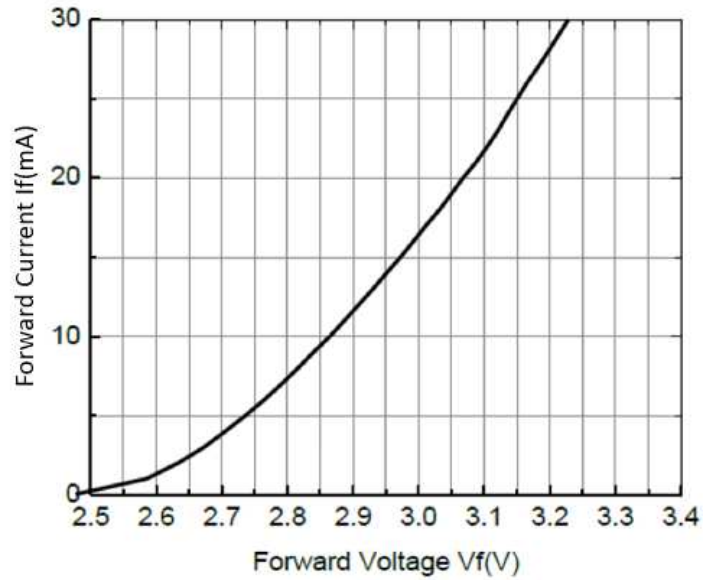
Typical Characteristic Curves

Ordering Information

Product	Emission Color	Technology	Test Current I_F (mA)	Luminous Intensity I_V (mcd) (Typ.)	Forward Voltage V_F (V) (Typ.)	Orderable Part Number
IN-P36BTEUW.27	White	InGaN	30	5000	3.0	IN-P36BTEUW.27
IN-P36BTEUW.30	White	InGaN	30	5000	3.0	IN-P36BTEUW.30
IN-P36BTEUW.35	White	InGaN	30	5000	3.0	IN-P36BTEUW.35
IN-P36BTEUW.40	White	InGaN	30	5500	3.0	IN-P36BTEUW.40
IN-P36BTEUW.45	White	InGaN	30	5500	3.0	IN-P36BTEUW.45
IN-P36BTEUW.50	White	InGaN	30	5800	3.0	IN-P36BTEUW.50
IN-P36BTEUW.56	White	InGaN	30	5800	3.0	IN-P36BTEUW.56
IN-P36BTEUW.60	White	InGaN	30	5800	3.0	IN-P36BTEUW.60
IN-P36BTEUW.65	White	InGaN	30	5800	3.0	IN-P36BTEUW.65
IN-P36BTEUW.70	White	InGaN	30	5800	3.0	IN-P36BTEUW.70

Label Specifications

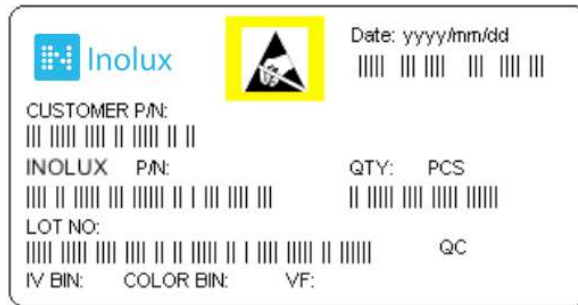

Inolux P/N:

I	N	-	P	3	6	B	T	E	U	W	
			Material	Package	Variation	Orientation	Current	Lens	Color	CCT	
Inolux			P = PLCC Type	36B = 3.6 x 3.1 x 3.1mm (60 Deg)		T = Top Mount	E = 30mA	(Blank) = Clear U = Diffused	W=White	27=2700K 30=3000K 35=3500K 40=4000K 45=4500K 50=5000K 56=5600K 60=6000K 65=6500K 70=7000K	

Lot No.:

Z	2	0	1	7	01	24	001
Internal Tracker	Year (2017, 2018,)				Month	Date	Serial

Packaging Information: 2000pcs Per Reel

Tape Dimension

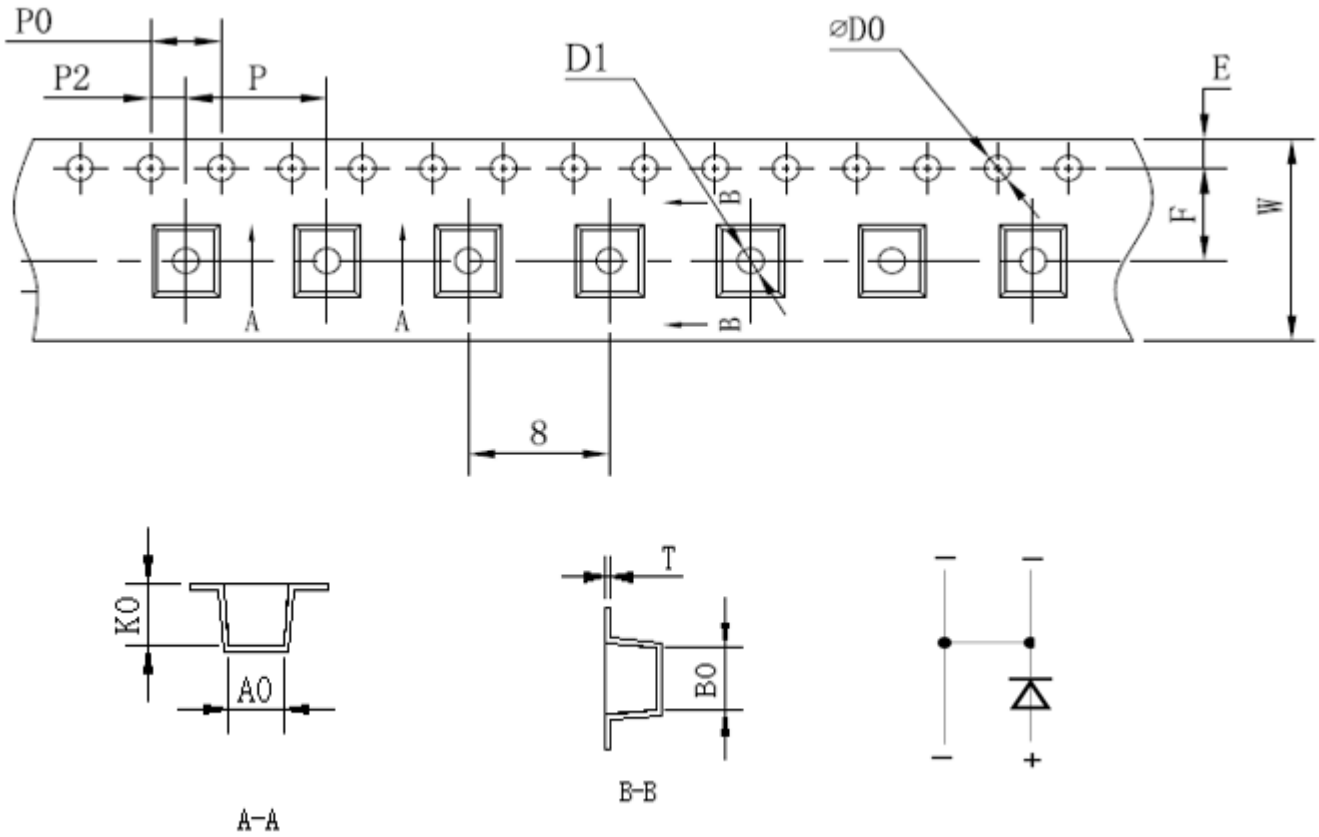

Symbol	A0	B0	K0	P0	P	P2	T
Spec	3.2±0.1	3.7±0.1	3.45±0.1	4.0±0.1	8.0±0.1	2.00±0.1	0.3±0.05
Symbol	E	F	D0	D1	W		
Spec	1.75±0.10	5.50±0.05	1.5±0.1	1.5±0.1	12±0.1		

Reel Dimension

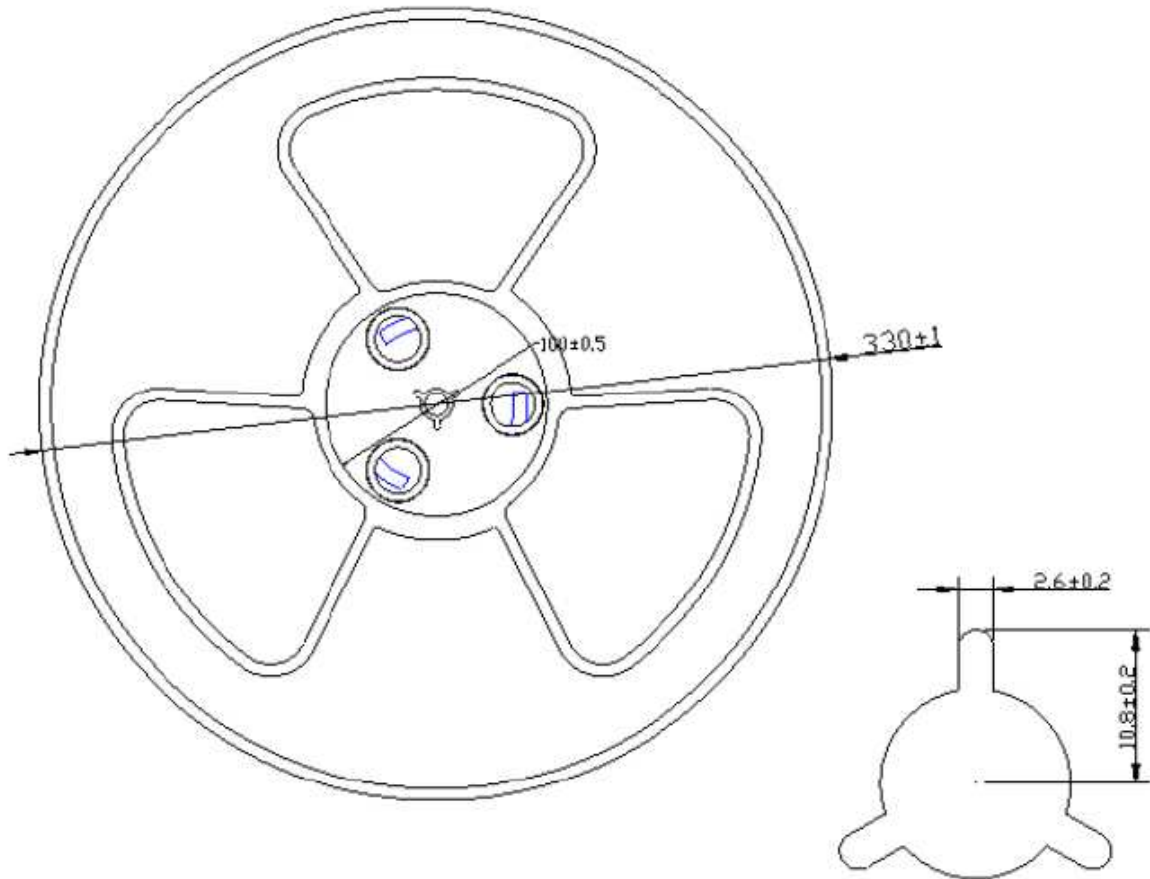

Unit: mm

Packing Dimension

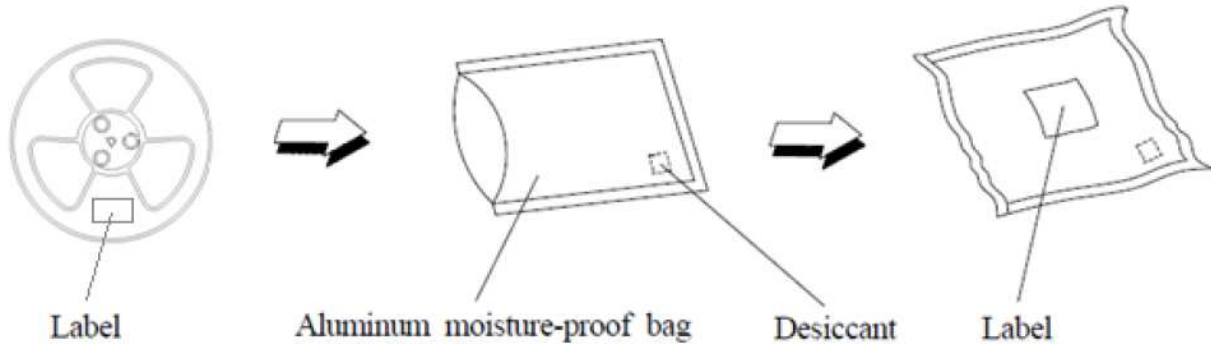

	Specification	Material	Quantity
Carrier tape	Per EIA 481-1A specs	Conductive black tape	2000pcs per reel
Reel	Per EIA 481-1A specs	Conductive black	
Label	IN standard	Paper	
Packing bag	220x240mm	Aluminum laminated bag/ no-zipper	One reel per bag
Carton	IN standard	Paper	Non-specified
Others: Each immediate box consists of 5 reels. The 5 reels may not necessarily have the same lot number or the same bin combinations of Iv, λD and Vf. Each reel has a label identifying its specification; the immediate box consists of a product label as well.			

Dry Pack

All SMD optical devices are **MOISTURE SENSITIVE**. Avoid exposure to moisture at all times during transportation or storage. Every reel is packaged in a moisture protected anti-static bag. Each bag is properly sealed prior to shipment.

Upon request, a humidity indicator will be included in the moisture protected anti-static bag prior to shipment.

The packaging sequence is as follows:

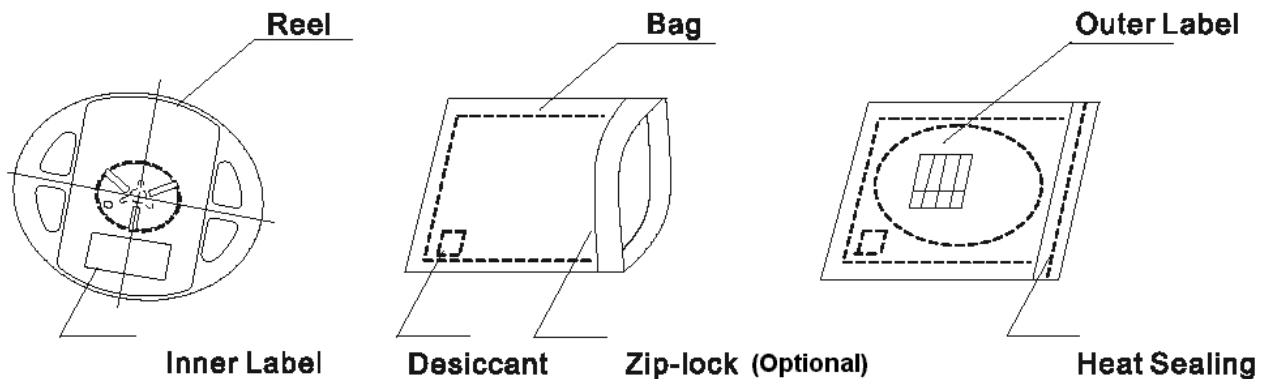

Reflow Soldering

- Recommended tin glue specifications: melting temperature in the range of 178~192 °C
- The recommended reflow soldering profile is as follows (temperatures indicated are as measured on the surface of the LED resin):

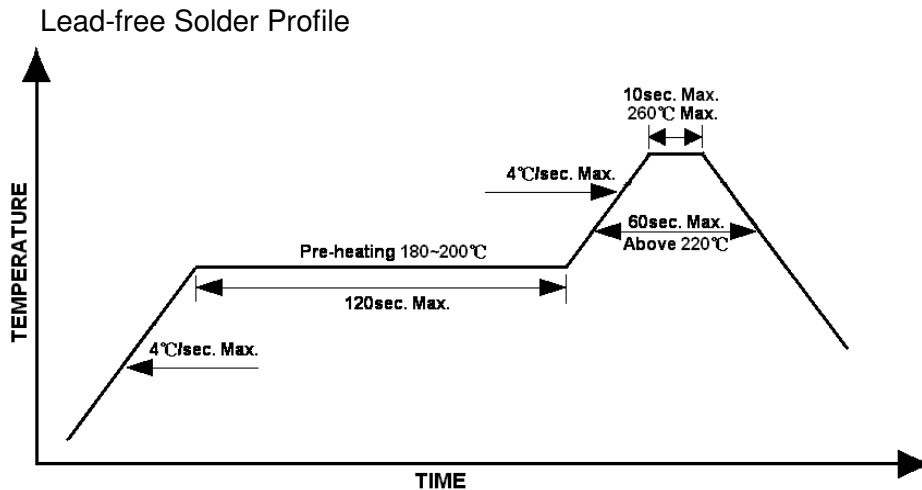

Precautions

- Avoid exposure to moisture at all times during transportation or storage.
- Anti-Static precaution must be taken when handling GaN, InGaN, and AlInGaP products.
- It is suggested to connect the unit with a current limiting resistor of the proper size. Avoid applying a reverse voltage.
- Avoid operation beyond the limits as specified by the absolute maximum ratings.
- Avoid direct contact with the surface through which the LED emits light.
- If possible, assemble the unit in a clean room or dust-free environment.

Reworking

- Rework should be completed within 5 seconds under 260 °C.
- The iron tip must not come in contact with the copper foil.
- Twin-head type is preferred.

Cleaning

Following are cleaning procedures after soldering:

- An alcohol-based solvent such as isopropyl alcohol (IPA) is recommended.
- Temperature x Time should be 50°C x 30sec. or <30°C x 3min
- Ultra sonic cleaning: < 15W/ bath; bath volume ≤ 1liter
- Curing: 100 °C max, <3min

Cautions of Pick and Place

- Avoid stress on the resin at elevated temperature.
- Avoid rubbing or scraping the resin by any object.
- Electro-static may cause damage to the component. Please ensure that the equipment is properly grounded. Use of an ionizer fan is recommended.

Reliability

Item	Frequency/ lots/ samples/ failures	Standards Reference	Conditions
Precondition	For all reliability monitoring tests according to JEDEC Level 3	J-STD-020	1.) Baking at 85°C for 24hrs 2.) Moisture storage at 30°C/ 60% R.H. for 192hrs
Solderability	1Q/ 1/ 22/ 0	JESD22-B102-B And CNS-5068	Accelerated aging 155°C/ 24hrs Tinning speed: 2.5+0.5cm/s Tinning: A: 215°C/ 3+1s or B: 260°C/ 10+1s
Resistance to soldering heat		CNS-5067	Dipping soldering terminal only Soldering bath temperature A: 260+/-5°C; 10+/-1s B: 350+/-10°C; 3+/-0.5s
Operating life test	1Q/ 1/ 40/ 0	CNS-11829	1.) Precondition: 85°C baking for 24hrs 85°C/ 60%R.H. for 168hrs 2.) Temp=25°C; IF=30mA; duration 1000hrs
High humidity, high temperature bias	1Q/ 1/ 45/ 0	JESD-A101-B	Temp: 85°C Humidity: 85% R.H., IF=5mA Duration: 1000hrs
High temperature bias	1Q/ 1/ 20	IN specs.	Temp: 55°C IF=30mA Duration: 1000hrs
Pulse life test	1Q/ 1/ 40/ 0		Temp=25°C, If=30mA,, Ip=100mA, Duty cycle=0.125 (tp=125 μs, T=1sec) Duration 500hrs)
Temperature cycle	1Q/ 1/ 76/ 0	JESD-A104-A IEC 68-2-14, Nb	A cycle: -40 degree C 15min; +85 degree C 15min Thermal steady within 5 min.. 300 cycles 2 chamber/ Air-to-air type
High humidity storage test	1Q/ 1/ 40/ 0	CNS-6117	60+3°C 90+5/-10% R.H. for 500hrs
High temperature storage test	1Q/ 1/ 40/ 0	CNS-554	100+10°C for 500hrs
Low temperature storage test	1Q/ 1/ 40/ 0	CNS-6118	-40+5°C for 500hrs

Revision History

Changes since last revision	Page	Version No.	Revision Date
Initial Release		1.0	02-03-2019

DISCLAIMER

INOLUX reserves the right to make changes without further notice to any products herein to improve reliability, function or design. INOLUX does not assume any liability arising out of the application or use of any product or circuit described herein; neither does it convey any license under its patent rights, nor the rights of others.

LIFE SUPPORT POLICY

INOLUX's products are not authorized for use as critical components in life support devices or systems without the express written approval of the President of INOLUX or INOLUX CORPORATION. As used herein:

1. Life support devices or systems are devices or systems which, (a) are intended for surgical implant into the body, or (b) support or sustain life, and (c) whose failure to perform when properly used in accordance with instructions for use provided in the labeling, can be reasonably expected to result in a significant injury of the user.
2. A critical component in any component of a life support device or system whose failure to perform can be reasonably expected to cause the failure of the life support device or system, or to affect its safety or effectiveness.

X-ON Electronics

Largest Supplier of Electrical and Electronic Components

Click to view similar products for [Standard LEDs - SMD category](#):

Click to view products by [Inolux manufacturer](#):

Other Similar products are found below :

[LTST-C190KYKT](#) [LTST-C19GD2WT](#) [LTST-N683GBEW](#) [LTW-170ZDC](#) [598-8110-100F](#) [598-8170-100F](#) [598-8610-202F](#) [67-22VRVGC/TR8](#) [AAAF5060QBFSEEZGS](#) [HLMP-6305-L0011](#) [ALMD-LB36-SV002](#) [APT1608QGW](#) [15-21UYC/S530-A3/TR8](#) [EAST2012YA0](#) [EASV1803BA0](#) [LG M67K-H1J2-24-0-2-R18-Z](#) [LS A676-P2S1-1](#) [SML310BATT86](#) [SML-LX0606SISUGC/A](#) [SML-LXL1307SRC-TR](#) [SML-LXR851SIUPGUBC](#) [LT1ED53A](#) [FAT801-S](#) [AM27ZGC03](#) [APB3025SGNC](#) [APFA3010SURKCGKQBDC](#) [APHK1608VGCA](#) [APT2012QGW](#) [LTST-C250KGKT](#) [LTW-010DCG](#) [LTW-020ZDCG](#) [LTW-21TS5](#) [LTW-220DS5](#) [LY L29K-H1J2-26](#) [UYGT801-S](#) [42-21UYC/S530-A3/TR8](#) [LO T67F-V1AB-24-1](#) [YGFR411-H](#) [598-8330-117F](#) [SML-LX0402IC-TR](#) [CMDA20AYAA7D1S](#) [CMDA16AYDR7A1X](#) [598-8040-100F](#) [598-8070-100F](#) [598-8140-100F](#) [598-8610-200F](#) [EAST2012GA0](#) [EAPL3527GA5](#) [EASV3020YGA0](#) [EAST1608RGBAO](#)