

### Features

- 4818 with integrated high quality constant current IC and RGBW LED chip.
- Built-in IC, with high precision of constant current and internal RGBW chips spectral processing in advance.
- Single line data transmission (return to zero code).
- Specific Shaping Transmit Technology - number of LED stacked is not restricted.
- Cascading Enhancement Technology - any 2 LED spacing can be up to 10 meters
- Data transfer rate of 800 kbp/s at 30 frames per second.
- RGB output port PWM control can achieve 256 grey level adjustments.
- Upon powering up, IC performs self-inspection then lights connection on the pin B lamp.
- SA-I Anti-interference patent technology for single line data transmission.
- Built-in power supply reverse connects protection module, reversed power input will not damage the IC.

### Description

The IN-PI4818QAS5R5G5BPW is 4.8\*1.8\*1.6mm RGBW LED with integrated IC. It is a side view SMD type LED which can be used in various applications.

### Applications

- Full color LED string light
- LED full color module
- LED guardrail tube
- LED scene lighting
- LED point light
- LED pixel screen
- LED shaped screen

### Package Outline Dimensions & Pin Configuration

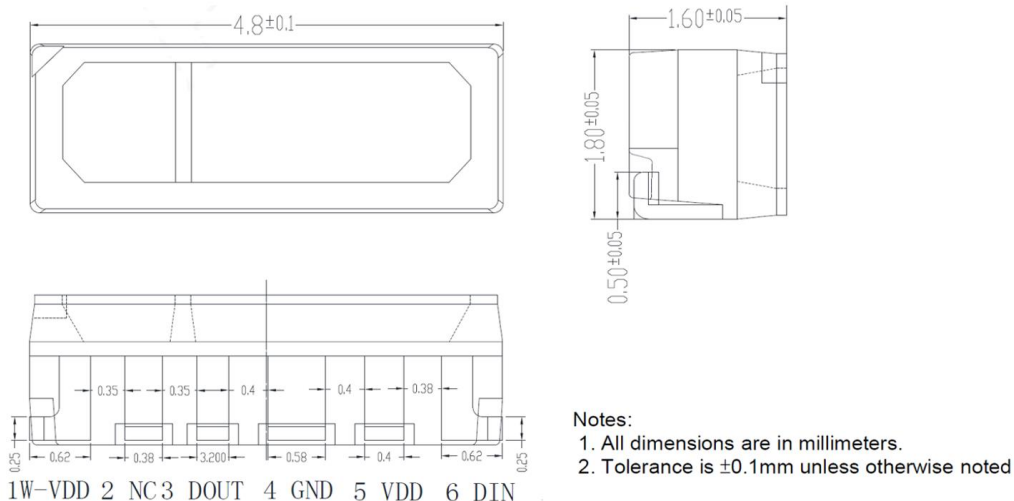
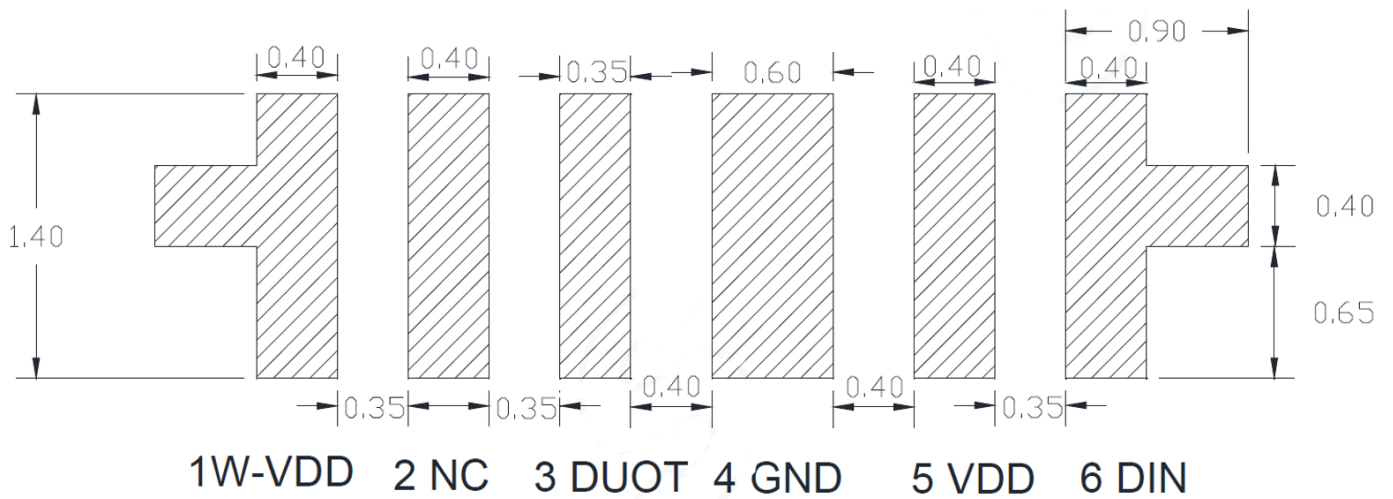

**Figure 1. IN-PI4818QAS5R5G5BPW Package Outline Dimensions**

### Pin Configuration

Number	Symbol	Function Description
1	W-VDD	Power supply LED
2	NC	NC (This pin does not do circuit design)
3	DOUT	Control data signal output
4	GND	Ground
5	VDD	Power supply LED
6	DIN	Control data signal input

### Recommended Soldering Pattern



**Absolute Maximum Rating** ( $T_a = 25\text{ }^\circ\text{C}$ ,  $V_{SS}=0V$ )

Parameter	Symbol	Range	Unit
Logic supply voltage	$V_{DD}$	+3.5~+5.5	V
Logic input voltage	$V_{IN}$	-0.5 ~VDD+0.5	V
Operating temperature	$T_{OPT}$	-45 ~ +85	$^\circ\text{C}$
Storage temperature	$T_{STG}$	-50 ~ +85	$^\circ\text{C}$
ESD pressure(HBM)	$V_{ESD}$	2K	V
ESD pressure(DM)	$V_{ESD}$	200	V

**LED Characteristics** ( $T_a = 25^\circ\text{C}$ )

Color	IN-PI4818QAS5R5G5BPW RGB@5mA W@12mA		
	Wavelength(nm)	Light Intensity(mcd)	Light Intensity(lm)
Red	620-630	120-240	/
Green	515-530	320-580	/
Blue	460-475	80-160	/
White	5500-1000K	1050-1500	4.7-6.55

**Recommended Operating Ranges** (unless otherwise specified,  $T_a = -20 \sim +70 \text{ }^\circ\text{C}$ ,  $V_{DD} = 4.5 \sim 5.5\text{V}$ ,  $V_{SS} = 0\text{V}$ )

Parameter	Symbol	Min.	Typ.	Max	Unit	Test conditions
Supply voltage	$V_{DD}$	-	5.2	-	V	-
High level input voltage	$V_{IH}$	0.7*VDD	-	-	V	VDD=5.0V
Low level input voltage	$V_{IL}$	-	-	0.3*VDD	V	VDD=5.0V
The frequency of PWM	$F_{PWM}$	-	4.0	-	KHZ	-
Static power consumption	$I_{DD}$	-	0.29	-	mA	-

**Switching Characteristics** (unless otherwise specified,  $T_a=25\text{ }^\circ\text{C}$ )

Parameter	Symbol	Min.	Typ.	Max	Unit	Test conditions
The speed of data transmission	$F_{DIN}$	-	800	-	KHZ	The duty ratio of 67% (data 1)
DOUT transmission delay	$T_{PLH}$	-	-	500	ns	DIN→DOUT
	$T_{PHL}$	-	-	500	ns	
$I_{OUT}$ Rise/Drop Time	$T_r$	-	100	-	ns	VDS=1.5V
	$T_f$	-	100	-	ns	

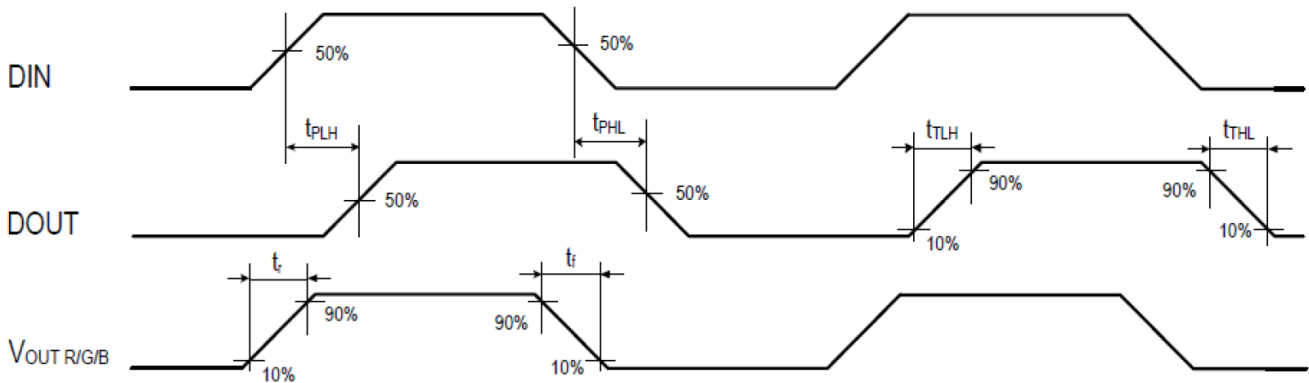

**Timing Waveforms**

1. Input Code

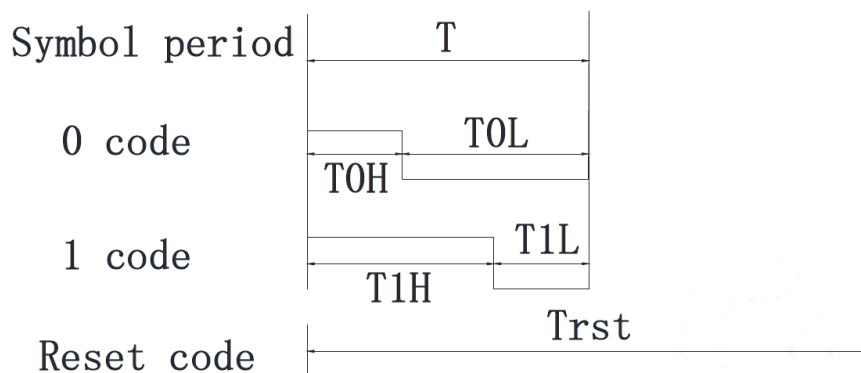

2. The data transmission time:

Name	Description	Min.	Typ. value	Max.	Unit
T	Period	1.2	-	-	μs
T0H	0 code, high level time	0.2	0.3	0.4	μs
T0L	0 code, low level time	0.8	-	-	μs
T1H	1 code, high level time	0.62	0.75	1.0	μs
T1L	1 code, low level time	0.2	-	-	μs
Trst	Reset code, low level time	>80	-	-	μs

3. Connection Scheme

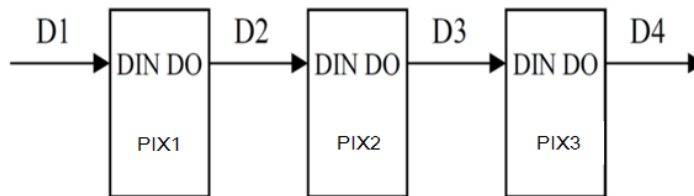

4. Data Transfer Format ( Ta=25°C )

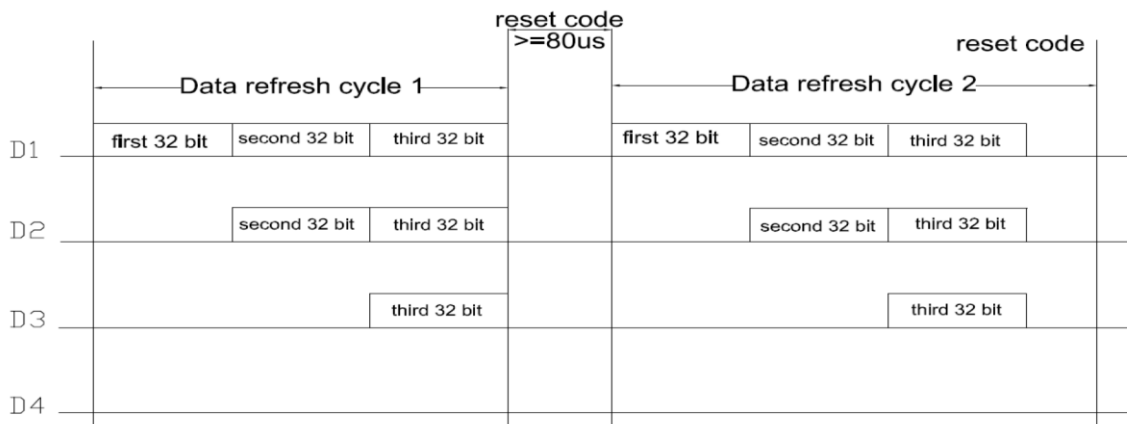

Note: the D1 sends data for MCU, D2, D3, D4 for data forwarding automatic shaping cascade circuit.

5. The data structure of 32bit:

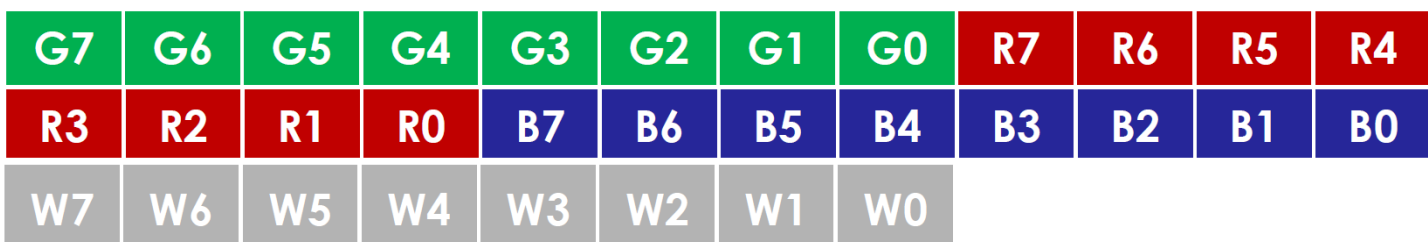

Note: high starting, in order to send data (G7 - G6 - ..... ..B0)

## Typical Application Circuit

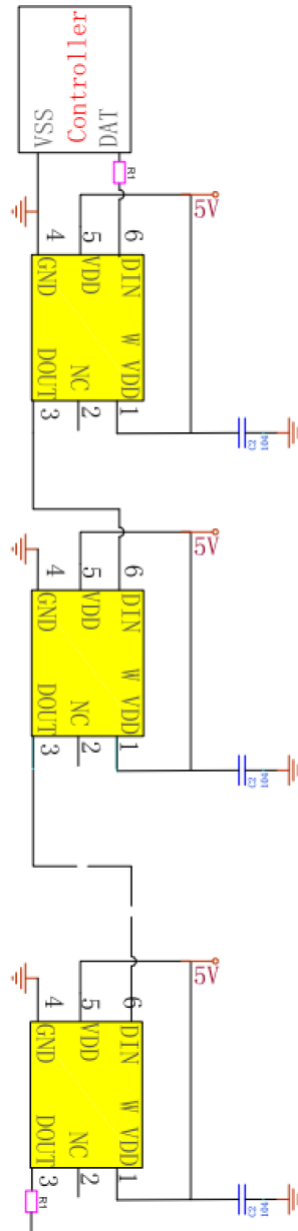

In the practical application circuit, the signal input and output pins of the IC signal input and output pins should be connected to the signal input and output terminals. In addition, to make the IC chip is more stable, even the capacitance between beads is essential back.

Application: used for soft lamp strip or hard light, lamp beads transmission distance is short, suggested in signal in time the clock line input and output end of each connected in series protection resistors, R1 of about 500 ohms.

Application: for module or general special-shaped products, lamp beads transmission distance is long, because of different wire and transmission distance, in the signal in time clock at both ends of the line on grounding protection resistance will be slightly different; to the actual use of fixed.

## LED Performance Graph

Thermal Pad Temperature vs. Relative Light Output

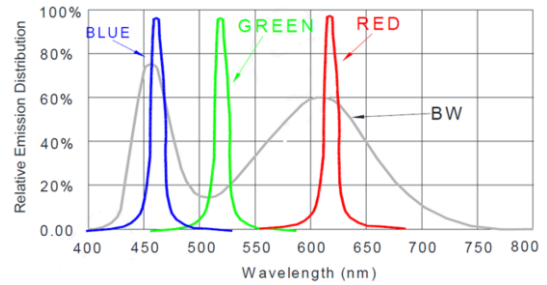
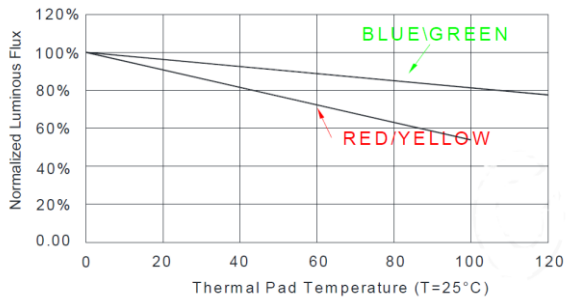

Typical Radiation Pattern 120°

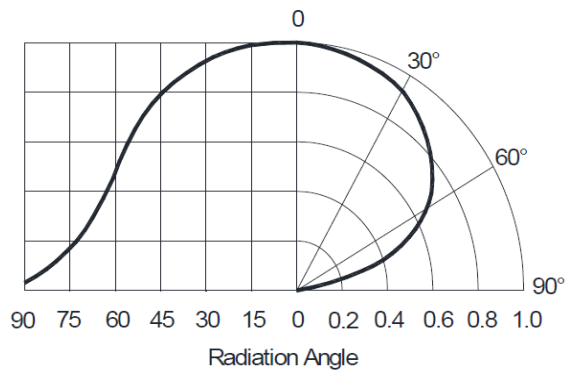



### White Color Temperature Ranks

Name	X1	Y1	X2	Y2	X3	Y3	X4	Y4
BW-A	0.2928	0.2822	0.2802	0.2895	0.2885	0.3007	0.3011	0.2934
BW-B	0.3011	0.2934	0.2885	0.3007	0.302	0.3189	0.3147	0.3116
BW-C	0.3147	0.3116	0.302	0.3189	0.3186	0.3412	0.3313	0.3339
BW-D	0.3313	0.3339	0.3186	0.3412	0.3326	0.36	0.3449	0.3522

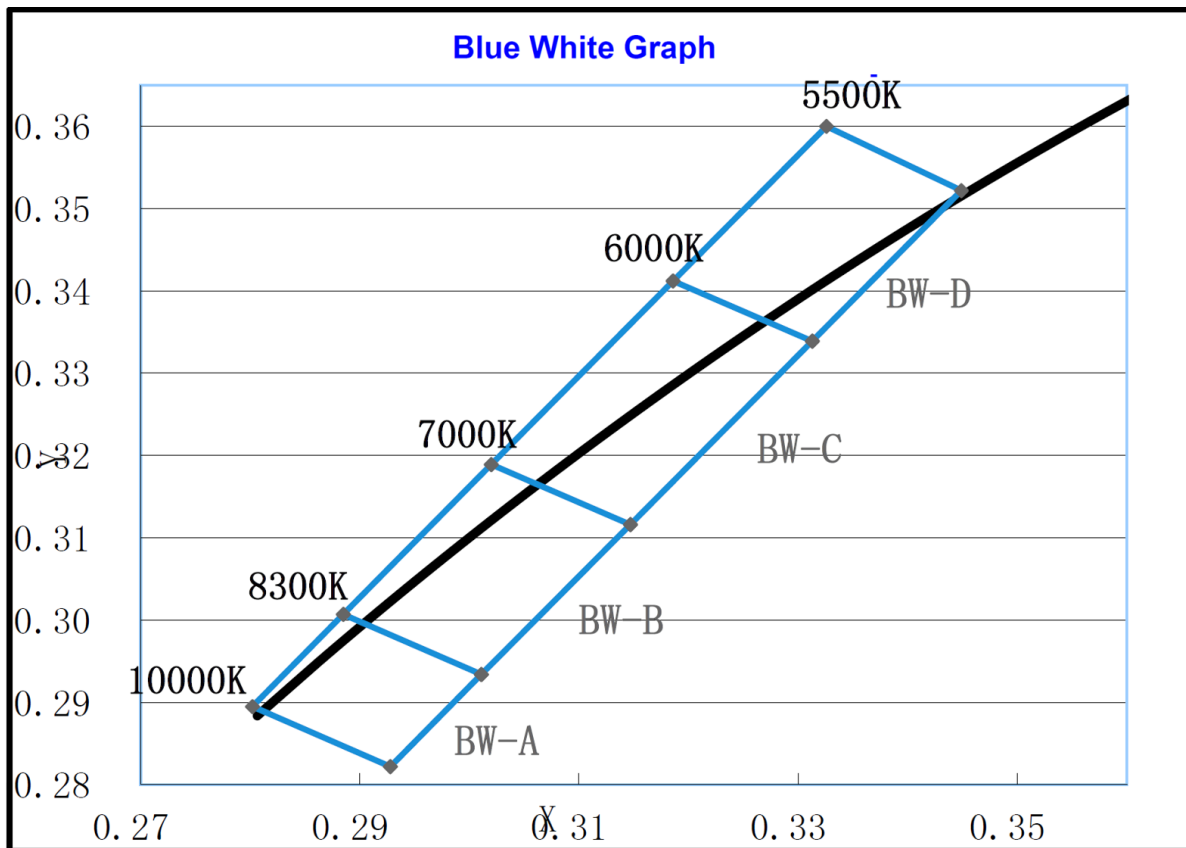

### Ordering Information

Product	Emission Color	IV(mcd)	Orderable Part Number
IN-PI4818QAS5R5G5BPW	R	120-240	IN-PI4818QAS5R5G5BPW
	G	320-580	
	B	80-160	
	W	1050-1500	

### Label Specifications

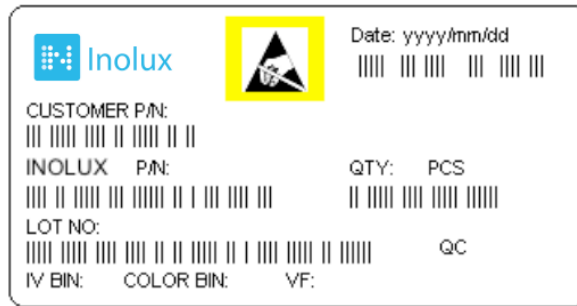

### Inolux P/N:

I	N	PI	-	4818	Q	A	S	5	R	5	G	5	B	P	W	-	X	X	X	X
Inolux		Product		Package	Die Qty.	Variation	Orientation	current	Color	current	Color	current	Color	current	Color					Customized Stamp-off
		PI- Single trace IC PC- Clock Function IC		4818QA= 4.8 x 1.8 x 1.6 mm Q: 4 dies			S = Side Mount	5=5mA	R = 624 nm	5=5mA	G = 520 nm	5=5mA	B = 470 nm	P=12mA	W: 5500-1000K					

### Lot No.:

Z	2	0	1	7	01	24	001
Internal Tracker	Year (2017, 2018, .....)				Month	Date	Serial

## Precautions

Please read the following notes before using the product:

### 1. Storage

- 1.1 Do not open moisture proof bag before the products are ready to use.
- 1.2 Before opening the package, the LEDs should be kept at 30°C or less and 80%RH or less.
- 1.3 The LEDs should be used within a year.
- 1.4 After opening the package, the remaining LEDs should be kept in a resealed bag.
- 1.5 The LEDs require mandatory baking before usage. Baking treatment listed below.
- 1.6 If the moisture adsorbent material has fabled away or the LEDs have exceeded the storage time, baking treatment should be performed using the following conditions.

\*Baking treatment: 60±5°C for 24 hours.

**2. Soldering Condition**

Recommended soldering conditions:

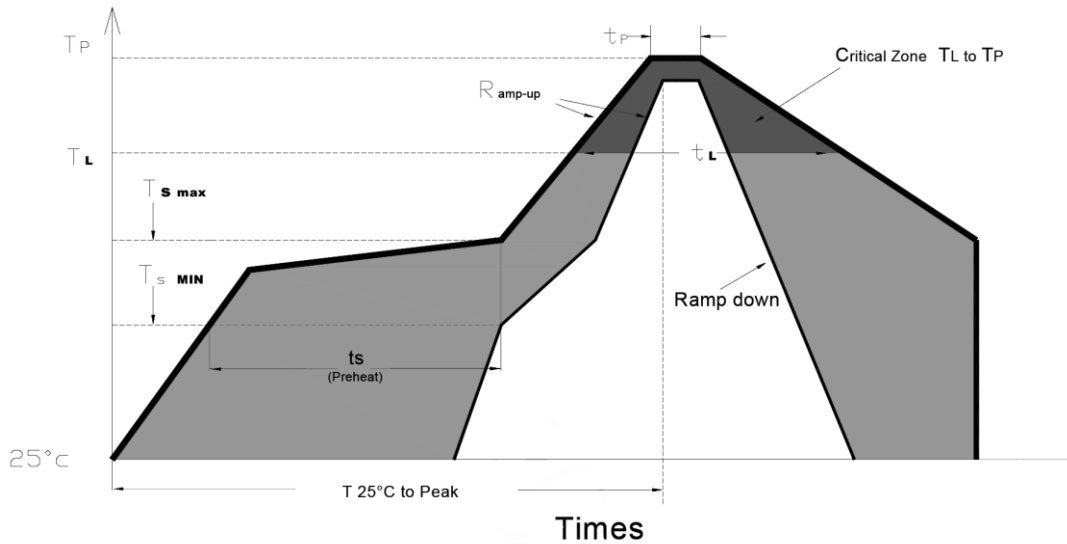

Profile Feature	Lead-Free Solder
Average Ramp-Up Rate ( $T_{s \max}$ to $T_p$ )	3°C/second max.
Preheat: Temperature Min ( $T_{s \min}$ )	150°C
Preheat: Temperature Min ( $T_{s \max}$ )	200°C
Preheat: Time ( $t_{s \min}$ to $t_{s \max}$ )	60-180 seconds
Time Maintained Above: Temperature ( $T_L$ )	217 °C
Time Maintained Above: Time ( $t_L$ )	60-150 seconds
Peak/Classification Temperature ( $T_p$ )	240 °C
Time Within 5°C of Actual Peak Temperature ( $t_p$ )	<10 seconds
Ramp-Down Rate	6°C/second max.
Time 25 °C to Peak Temperature	<6 minutes max.

Note: Excessive soldering temperature and / or time might result in deformation of the LED lens or catastrophic failure of the LED.

### 3. Soldering Iron

Each terminal is to go to the tip of soldering iron temperature less than 260°C for 5 seconds within once in less than the soldering iron capacity 25W. Leave two seconds and more intervals, and do soldering of each terminal. Be careful because the damage of the product is often started at the time of the hand solder.

### 4. Repairing

Repair should not be done after the LEDs have been soldered. When repairing is unavoidable, a double-head soldering iron should be used (as below figure). It should be confirmed beforehand whether the characteristics of the LEDs will or will not be damaged by repairing.

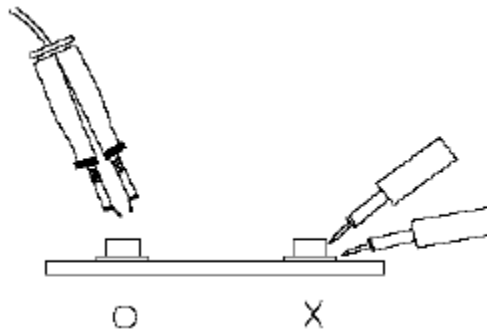

### 5. Caution in ESD

Static Electricity and surge damages the LED. It is recommended to use a wristband or anti-electrostatic glove when handling the LED. All devices, equipment and machinery must be properly grounded.

## Revision History

Changes since last revision	Page	Version No.	Revision Date
Initial Release		1.0	05-06-2021
Format Update	1, 3, 10	1.1	06-09-2021

## DISCLAIMER

INOLUX reserves the right to make changes without further notice to any products herein to improve reliability, function or design. INOLUX does not assume any liability arising out of the application or use of any product or circuit described herein; neither does it convey any license under its patent rights, nor the rights of others.

## LIFE SUPPORT POLICY

INOLUX's products are not authorized for use as critical components in life support devices or systems without the express written approval of the President of INOLUX or INOLUX CORPORATION. As used herein:

1. Life support devices or systems are devices or systems which, (a) are intended for surgical implant into the body, or (b) support or sustain life, and (c) whose failure to perform when properly used in accordance with instructions for use provided in the labeling, can be reasonably expected to result in a significant injury of the user.
2. A critical component in any component of a life support device or system whose failure to perform can be reasonably expected to cause the failure of the life support device or system, or to affect its safety or effectiveness.

## X-ON Electronics

Largest Supplier of Electrical and Electronic Components

*Click to view similar products for [Standard LEDs - SMD category](#):*

*Click to view products by [Inolux manufacturer](#):*

Other Similar products are found below :

[LTST-C19GD2WT](#) [LTST-N683GBEW](#) [LTW-170ZDC](#) [LTW-M140SZS40](#) [598-8110-100F](#) [598-8170-100F](#) [598-8610-202F](#) [67-22VRVGC/TR8](#) [AAAF5060QBFSEEZGS](#) [HLMP-6305-L0011](#) [ALMD-LB36-SV002](#) [APT1608QGW](#) [15-21UYC/S530-A3/TR8](#) [EASV1803BA0](#) [LG M67K-H1J2-24-0-2-R18-Z](#) [LS A676-P2S1-1](#) [SML310BATT86](#) [SML-512VWT86A](#) [SML-LX0606SISUGC/A](#) [SML-LXL1307SRC-TR](#) [SML-LXR851SIUPGUBC](#) [LT1ED53A](#) [FAT801-S](#) [AM27ZGC03](#) [APB3025SGNC](#) [APFA3010SURKCGKQBDC](#) [APHK1608VGCA](#) [APT2012QGW](#) [CLX6D-FKB-CN1R1H1BB7D3D3](#) [LTST-C250KGKT](#) [LTW-020ZDCG](#) [LTW-21TS5](#) [LTW-220DS5](#) [JANTXM19500/521-02](#) [UYGT801-S](#) [LO T67F-V1AB-24-1](#) [YGFR411-H](#) [598-8330-117F](#) [SML-LX0402IC-TR](#) [CMDA20AYAA7D1S](#) [CMDA16AYDR7A1X](#) [339-1SURYGW/S530-A2](#) [598-8040-100F](#) [598-8070-100F](#) [598-8140-100F](#) [598-8610-200F](#) [EAPL3527GA5](#) [67-11/BHC-M1N2B8Y/2A0](#) [SML-LXL1209SYC/ATR](#) [EASV3020YGA0](#)