

## Features

- 0402 0.55mm SMD LED
- High Brightness
- AllnGaP / InGaN Technology
- Small package
- High reliability
- Clear Lens

## Applications

- Consumer Electronics
- Wearables
- Automobile After Market
- Industrial Equipment

## Description

The IN-S42DS series is a popular low profile 0402 package with versatile design capabilities. It is a PCB type molding style LED which can be used in various applications.

## Recommended Solder Pattern

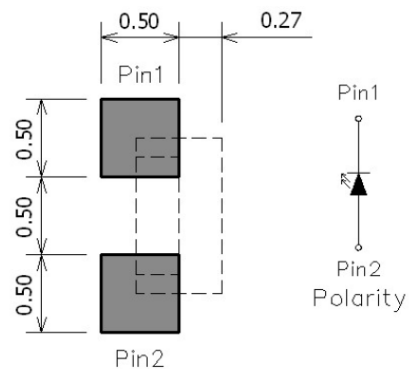

**Figure 1. IN-S42DS Solder Pattern**

## Package Dimensions in mm

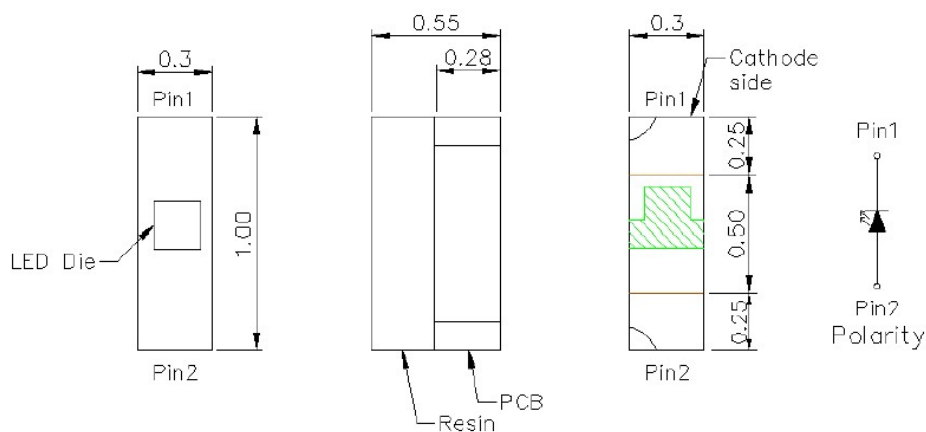

### Notes.

1. All dimensions are in millimeters.
2. Tolerance is  $\pm 0.10$  mm unless otherwise noted

**Figure 2. IN-S42DS Package Dimensions**

### Absolute Maximum Rating at 25°C (Note 1)

Product	Emission Color	$P_d$ (mW)	$I_f$ (mA)	$I_{FP}^*$ (mA)	$V_R$ (V)	$T_{OP}$ (°C)	$T_{ST}$ (°C)
IN-S42DS5SR	Super Red	48	20	100	5	-40°C~+85°C	-40°C~+100°C
IN-S42DS5R	Red	48	20	100	5	-40°C~+85°C	-40°C~+100°C
IN-S42DS5YG	Yellow Green	48	20	100	5	-40°C~+85°C	-40°C~+100°C
IN-S42DS5Y	Yellow	48	20	100	5	-40°C~+85°C	-40°C~+100°C
IN-S42DS5A	Amber	48	20	100	5	-40°C~+85°C	-40°C~+100°C
IN-S42DS5B	Blue	15.75	5	80	5	-40°C~+85°C	-40°C~+100°C
IN-S42DS5G	Green	78	20	80	5	-40°C~+85°C	-40°C~+100°C
IN-S42DS5UW	White	36	10	80	5	-40°C~+85°C	-40°C~+100°C

### Notes

1. Condition for IFP is pulse of 1/10 duty and 0.1msec width

### ESD Precaution

ATTENTION: Electrostatic Discharge (ESD) protection



The symbol above denotes that ESD precaution is needed. ESD protection for GaP and AlGaAs based chips is necessary even though they are relatively safe in the presence of low static-electric discharge. Parts built with AlInGaP, GaN, or/and InGaN based chips are STATIC SENSITIVE devices. ESD precaution must be taken during design and assembly.

If manual work or processing is needed, please ensure the device is adequately protected from ESD during the process.

Please be advised that normal static precautions should be taken in the handling and assembly of this device to prevent damage or degradation which may be induced by electrostatic discharge (ESD).

**Electrical Characteristics**  $T_A = 25^\circ\text{C}$  (Note 1)

Product	Emission Color	$I_F(\text{mA})$	$V_F(\text{V})$		$\lambda(\text{nm})$			Viewing Angle	$I_V^*(\text{mcd})$
			typ.	max	$\lambda_D$	$\lambda_P$	$\Delta\lambda$	$2\theta_{1/2}$	typ.
IN-S42DS5SR	Super Red	5	2.0	2.4	631	639	20	145	18.0
IN-S42DS5R	Red	5	2.0	2.4	624	632	20	145	28.5
IN-S42DS5YG	Yellow Green	5	2.1	2.4	571	573	15	145	11.25
IN-S42DS5Y	Yellow	5	2.0	2.4	589	591	20	145	18.0
IN-S42DS5A	Amber	5	2.0	2.4	605	611	17	145	28.5
IN-S42DS5B	Blue	5	2.8	3.15	472	470	40	145	28.5
IN-S42DS5G	Green	5	2.7	3.0	529	522	40	145	71.5
IN-S42DS5UW	White	5	2.9	3.25	X=0.290 Y=0.285	-	-	X=150 Y=140	200.0

**Notes**

1. Performance guaranteed only under conditions listed in above tables.

**Chromaticity Bin (for White only)**

Bin Code	CIE-X	CIE-Y	Bin Code	CIE-X	CIE-Y
C1	0.2500	0.2050	C2	0.2700	0.2325
	0.2500	0.2500		0.2700	0.2775
	0.2700	0.2775		0.2900	0.3050
	0.2700	0.2325		0.2900	0.2600
Bin Code	CIE-X	CIE-Y	Bin Code	CIE-X	CIE-Y
D1	0.2900	0.2600	D2	0.3100	0.2875
	0.2900	0.3025		0.3100	0.3325
	0.3100	0.3325		0.3300	0.3600
	0.3100	0.2875		0.3300	0.3150

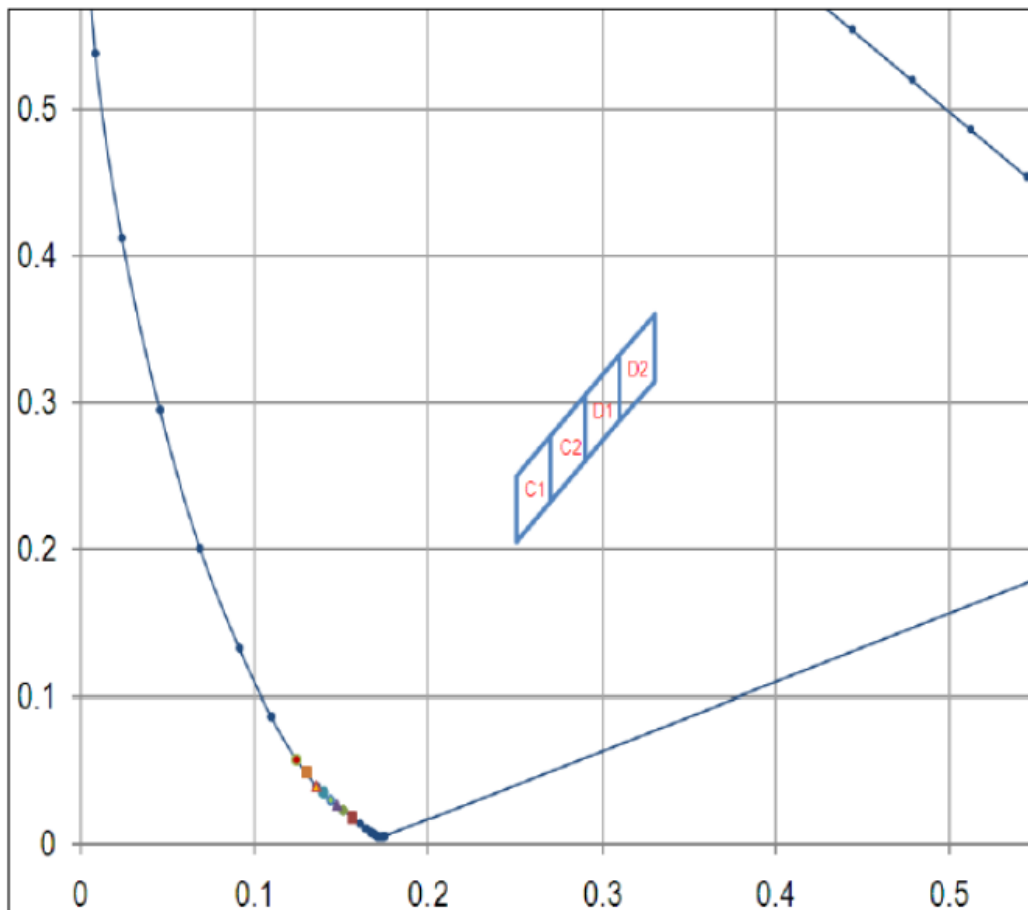

### Typical Characteristic Curves – A

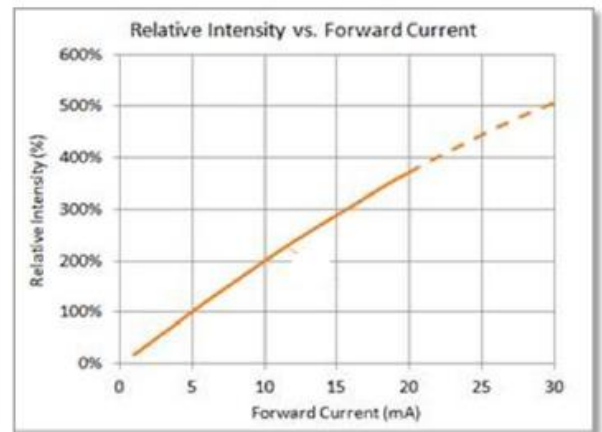
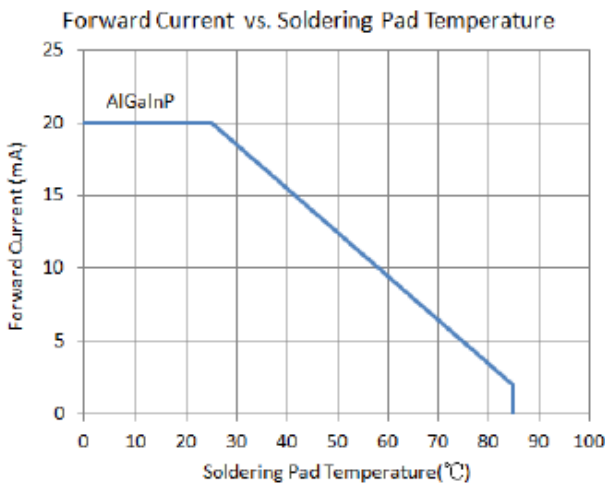
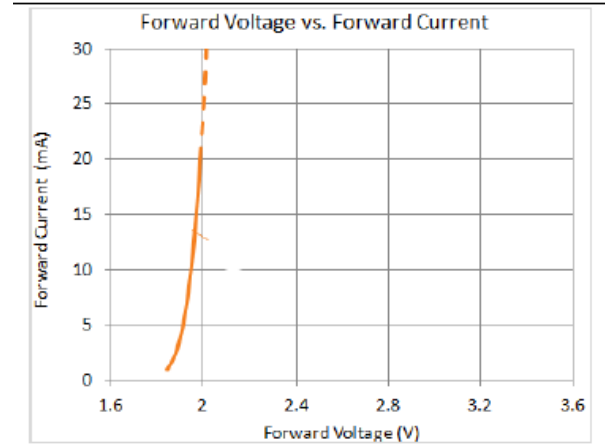
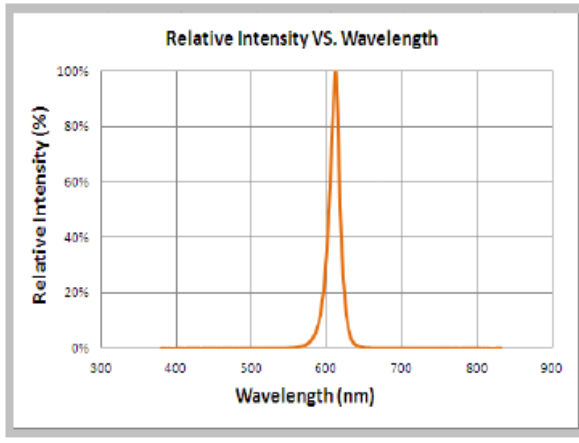

### Typical Characteristic Curves – Radiation Pattern

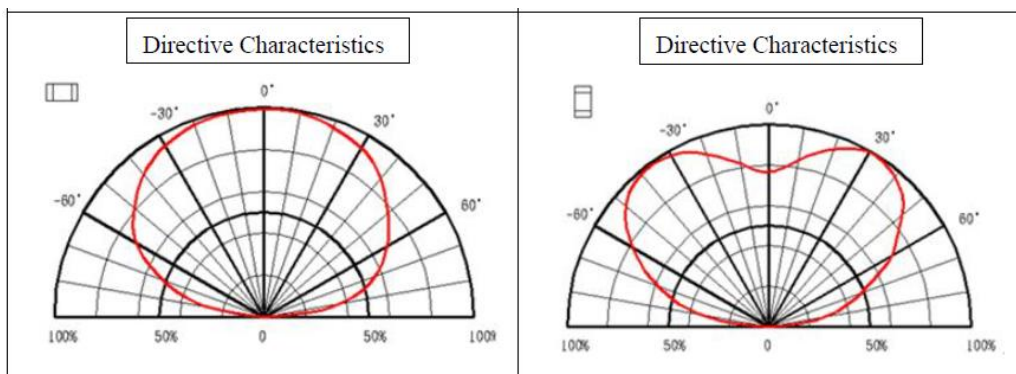

### Typical Characteristic Curves –SR

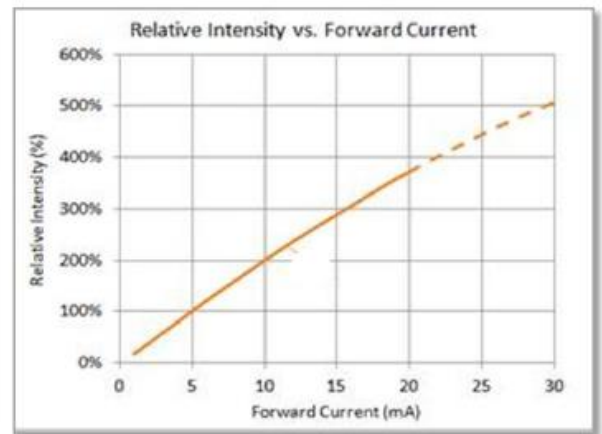
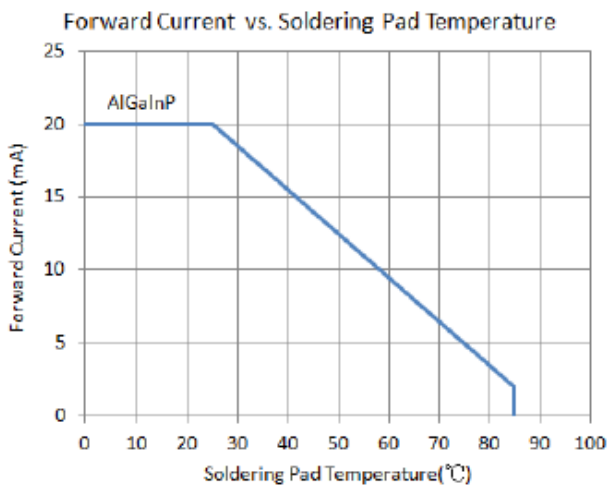
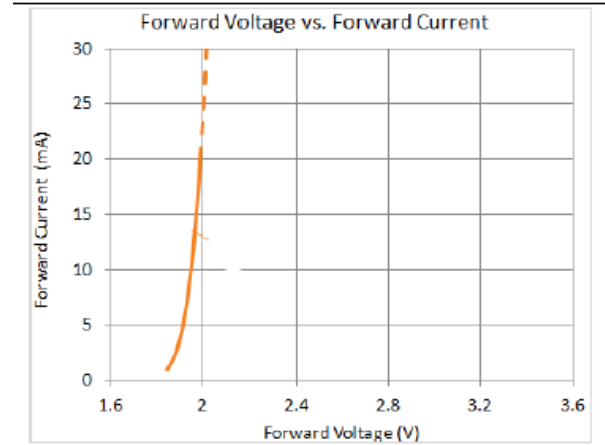
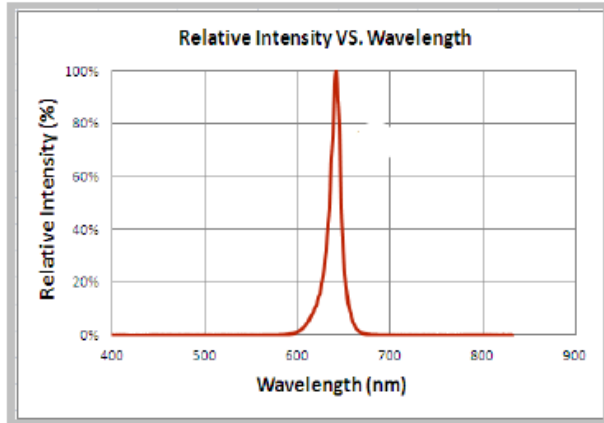

### Typical Characteristic Curves – Radiation Pattern

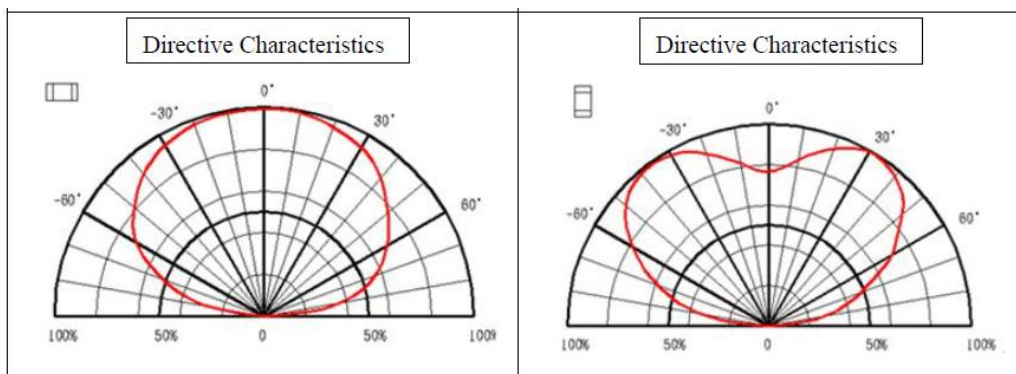

### Typical Characteristic Curves –R

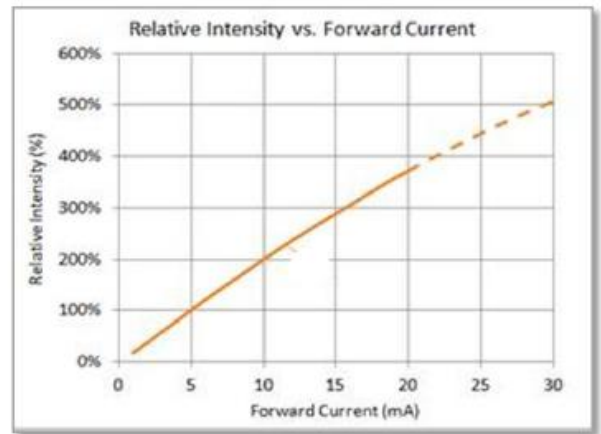
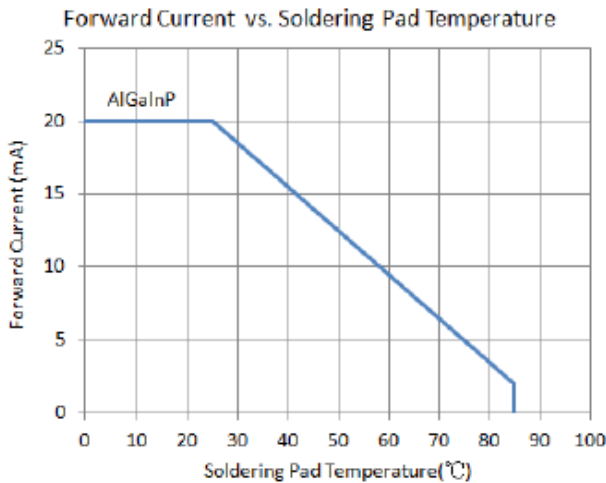
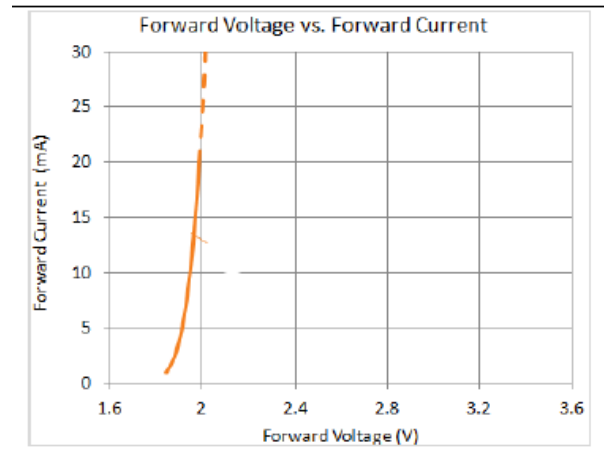
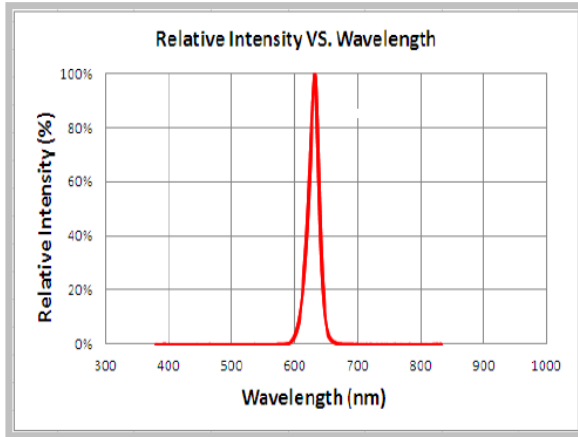

### Typical Characteristic Curves – Radiation Pattern

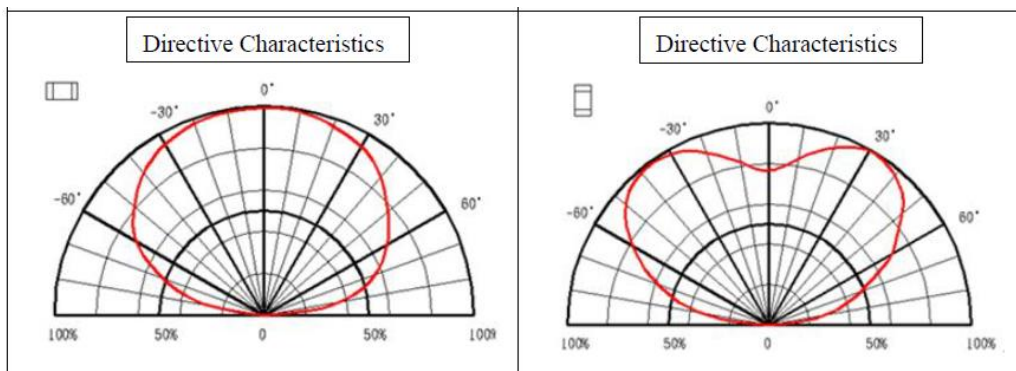

### Typical Characteristic Curves –Y

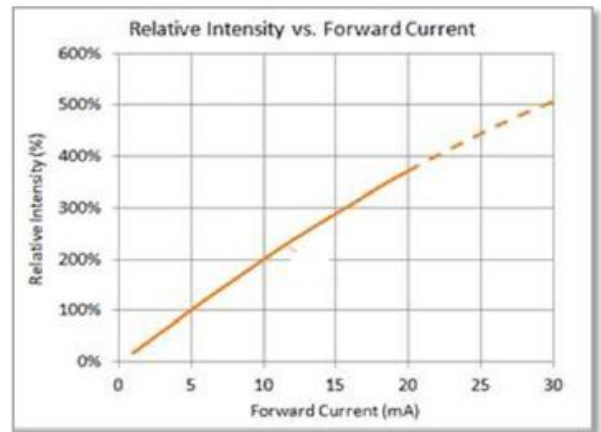
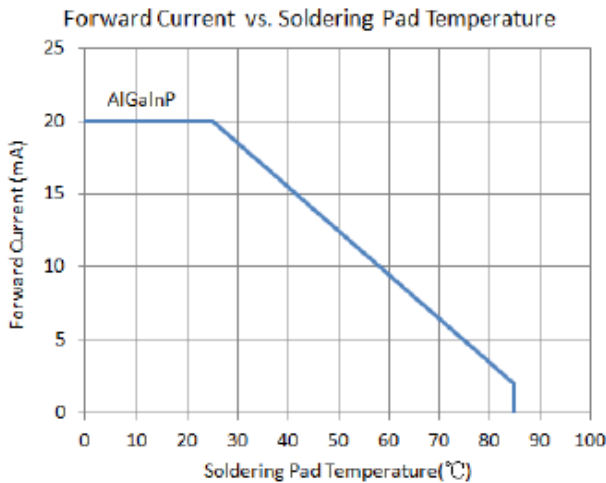
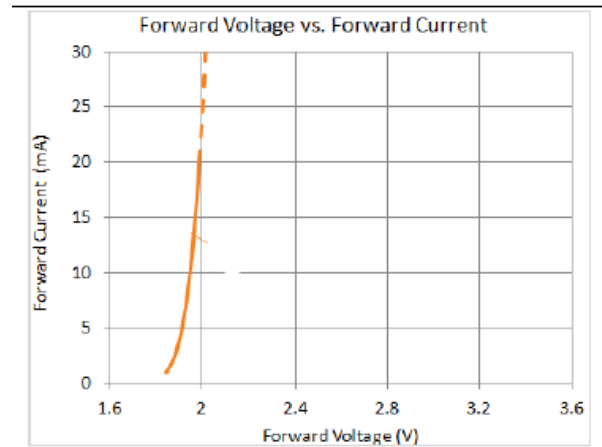
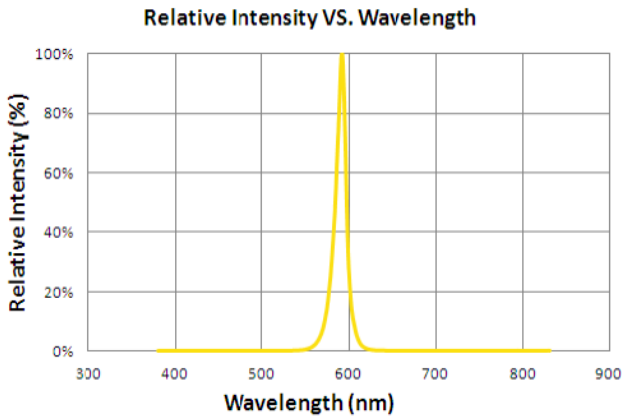

### Typical Characteristic Curves – Radiation Pattern

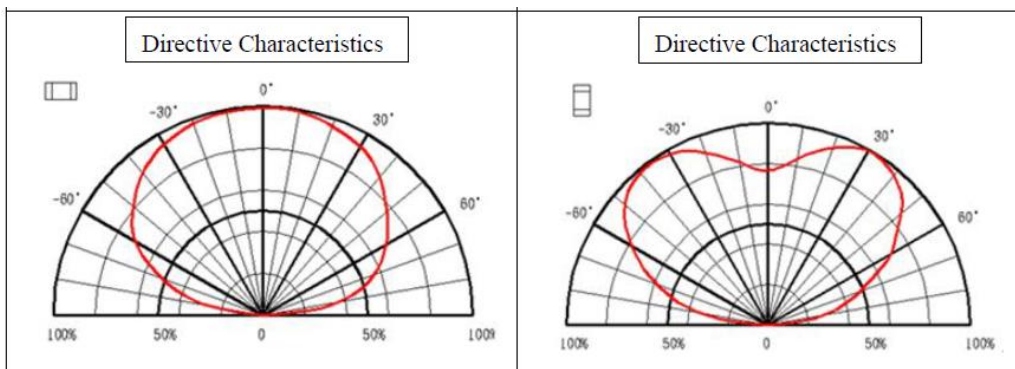



### Typical Characteristic Curves – YG

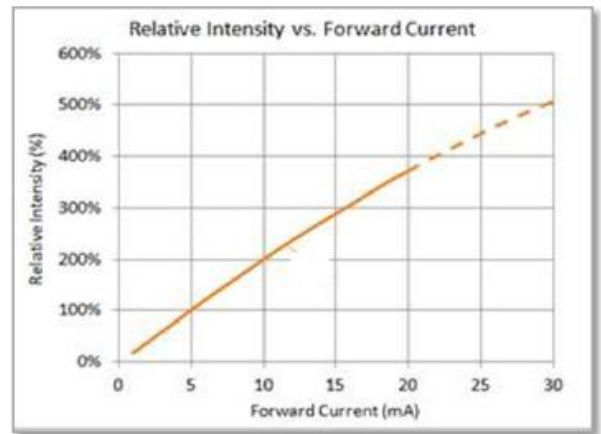
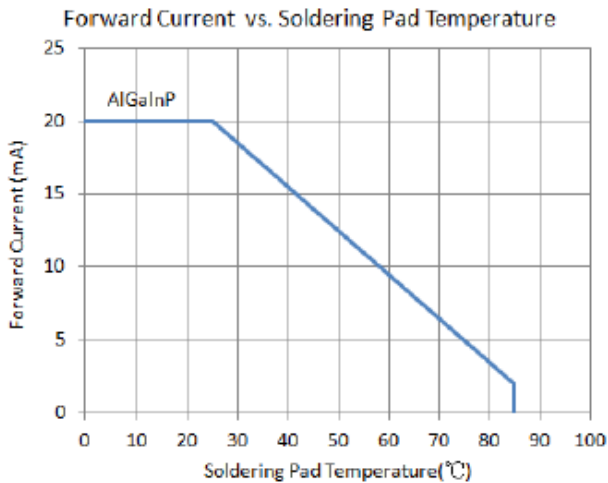
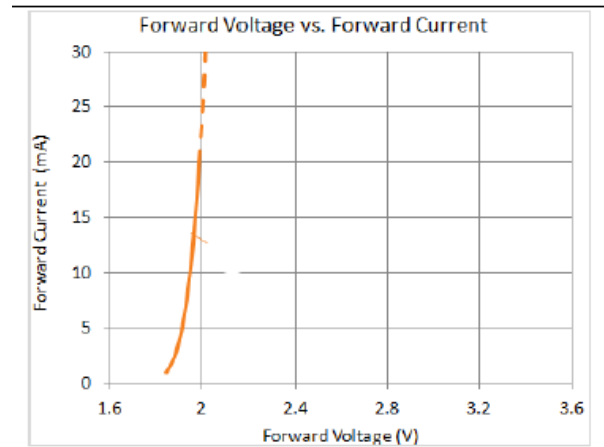
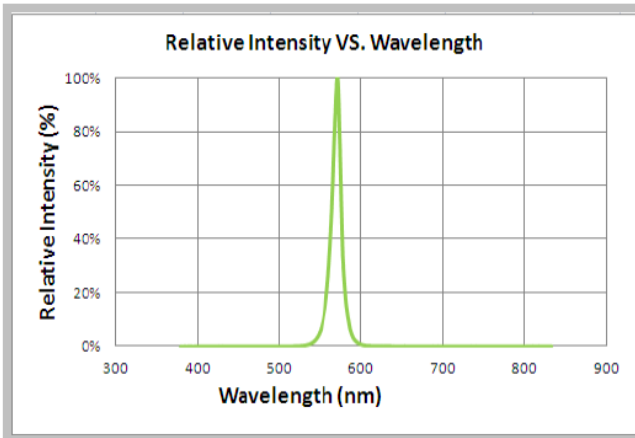

### Typical Characteristic Curves – Radiation Pattern

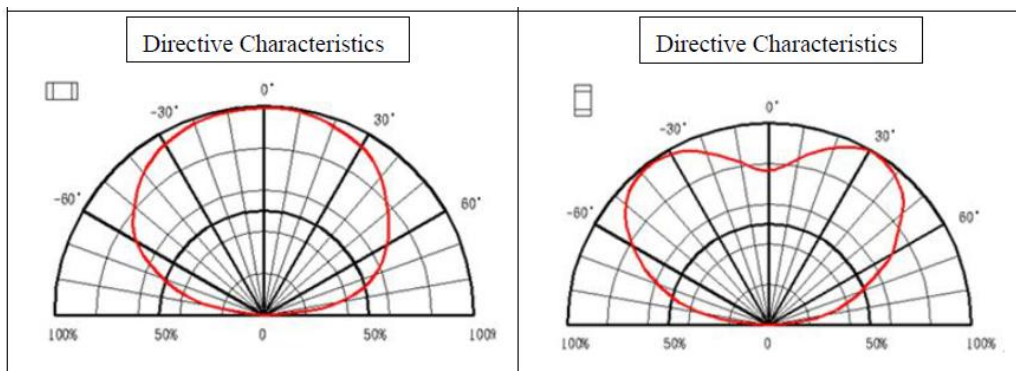

### Typical Characteristic Curves –G

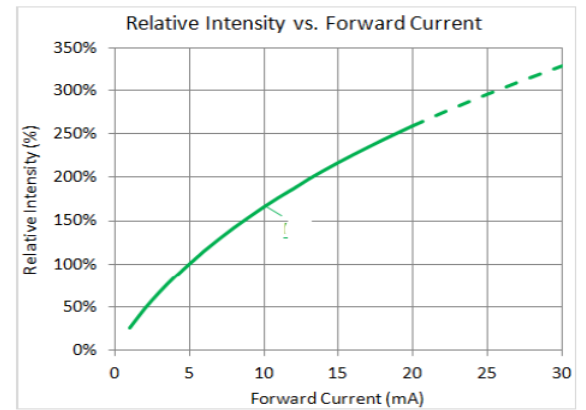
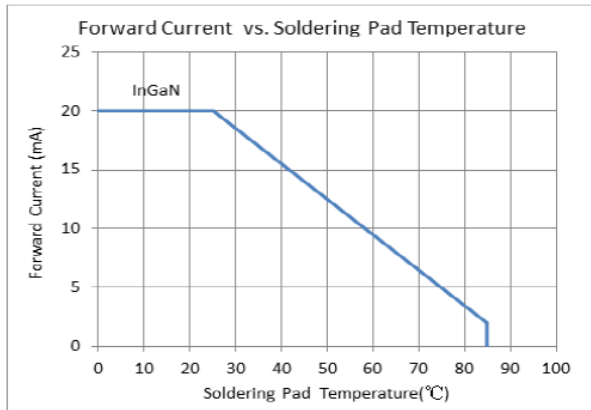
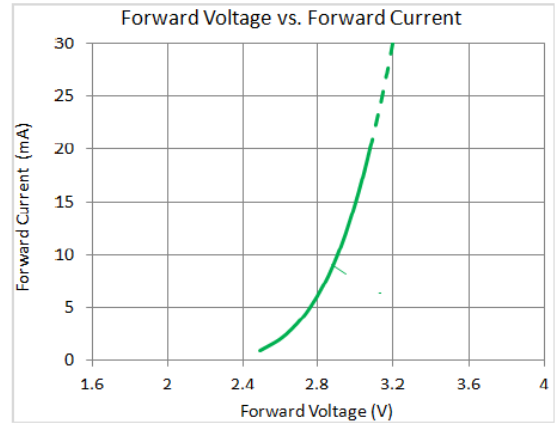
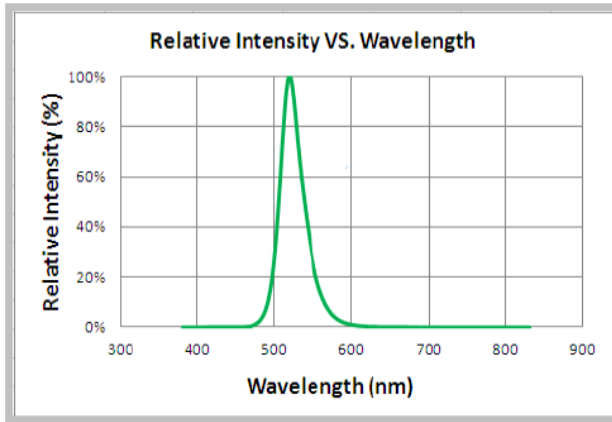

### Typical Characteristic Curves – Radiation Pattern

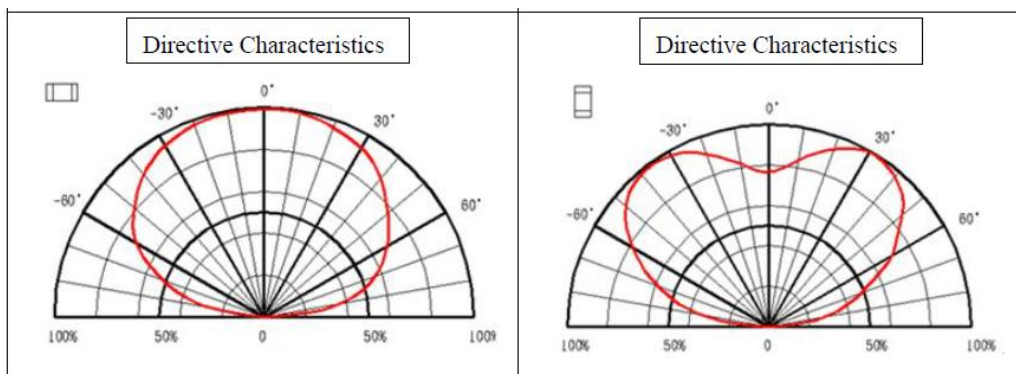

### Typical Characteristic Curves –B

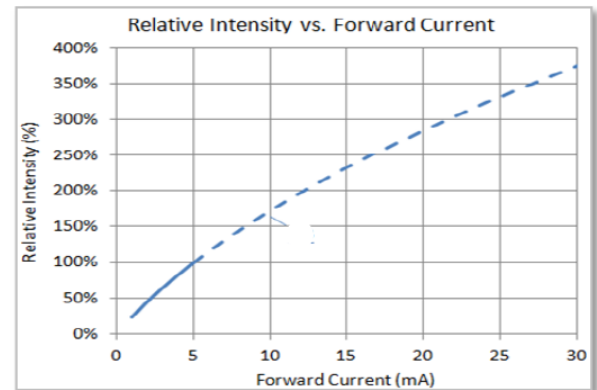
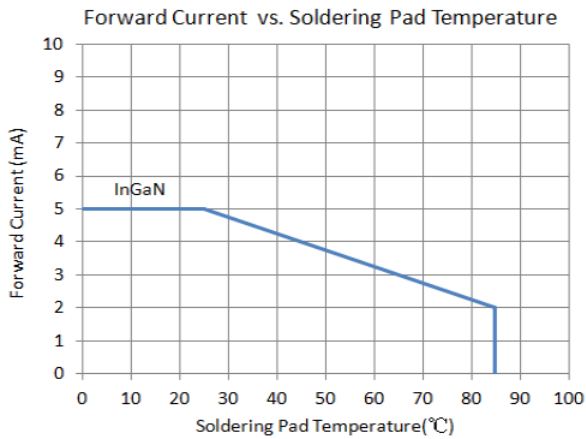
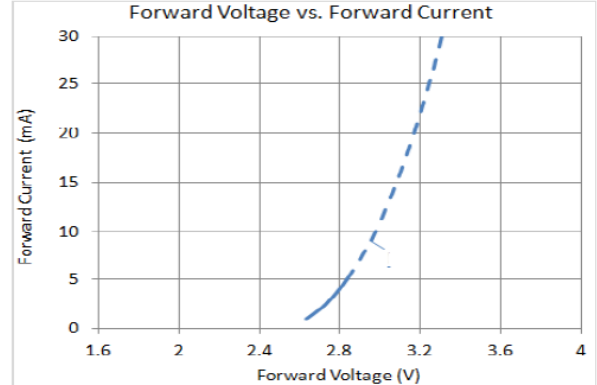
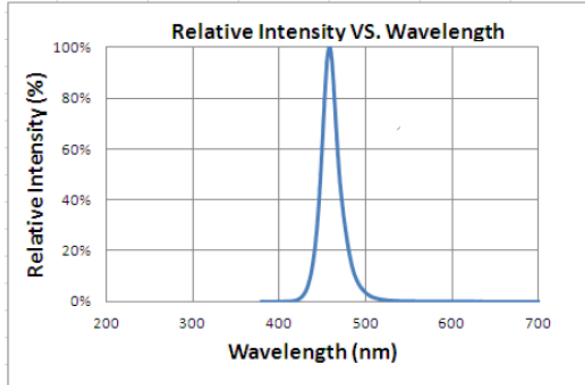

### Typical Characteristic Curves – Radiation Pattern

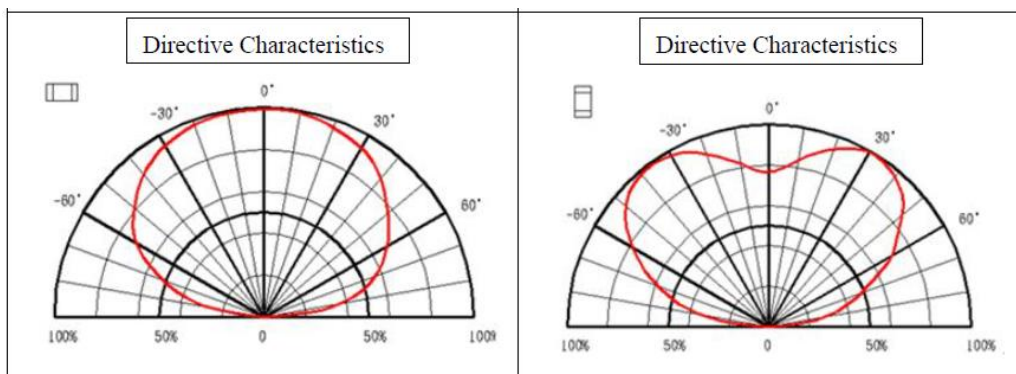

### Typical Characteristic Curves –W

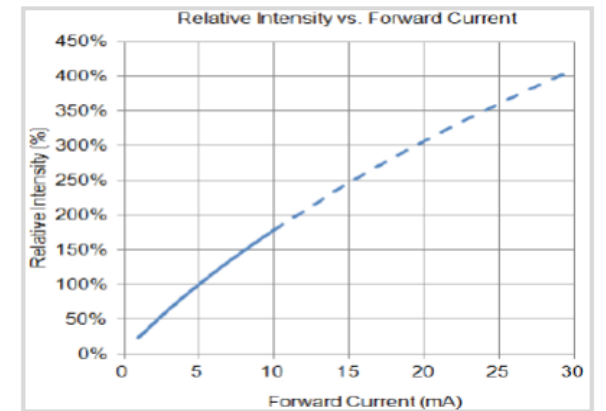
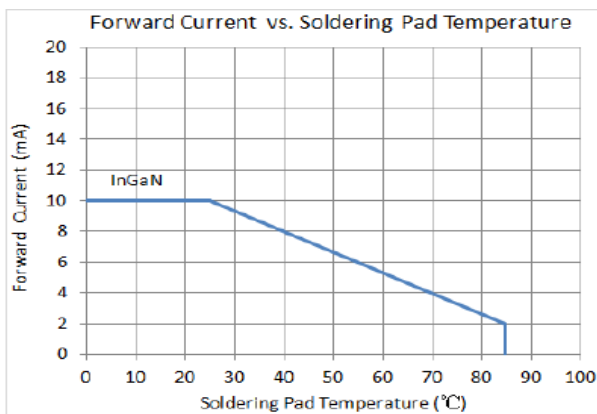
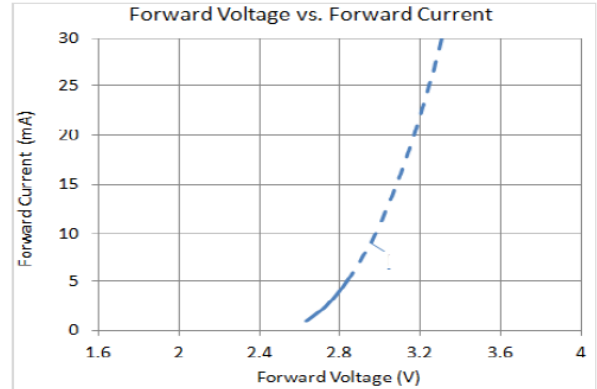
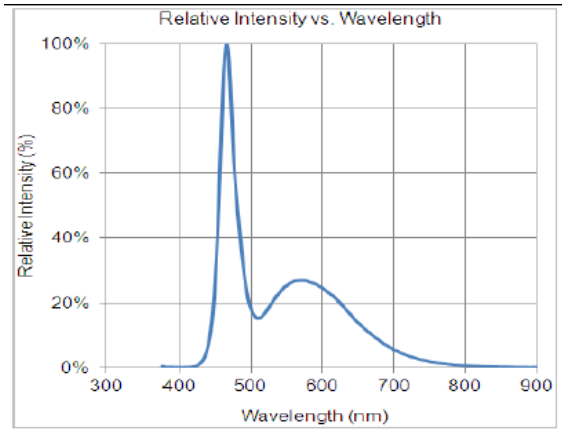

### Typical Characteristic Curves – Radiation Pattern

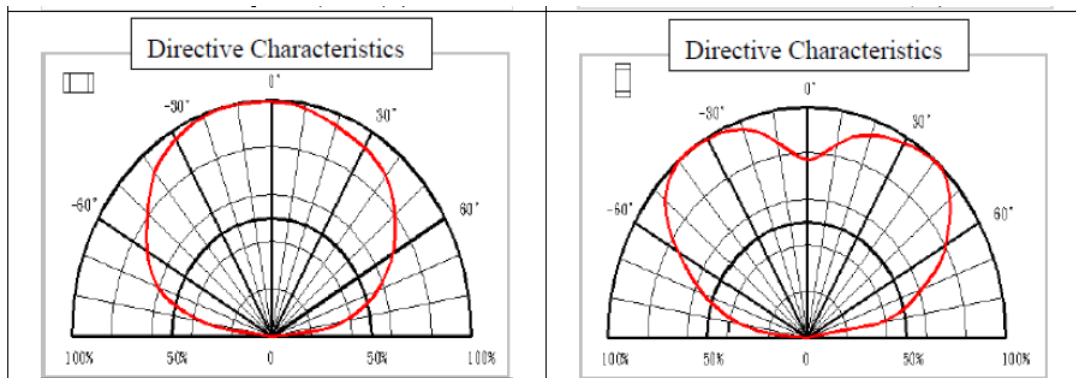

## Ordering Information

Product	Emission Color	Technology	Test Current $I_F$ (mA)	Luminous Intensity $I_V$ (mcd) (Typ.)	Forward Voltage $V_F$ (V) (Typ.)	Orderable Part Number
IN-S42DS5SR	Super Red	AllnGaP	5	18.0	2.0	IN-S42DS5SR
IN-S42DS5R	Red	AllnGaP	5	28.5	2.0	IN-S42DS5R
IN-S42DS5YG	Yellow Green	AllnGaP	5	11.5	2.0	IN-S42DS5YG
IN-S42DS5Y	Yellow	AllnGaP	5	23	2.0	IN-S42DS5Y
IN-S42DS5A	Amber	AllnGaP	5	28.5	2.0	IN-S42DS5A
IN-S42DS5B	Blue	InGaN	5	28.5	2.8	IN-S42DS5B
IN-S42DS5G	Green	InGaN	5	71.5	2.8	IN-S42DS5G
IN-S42DS5UW	White	InGaN	5	200	2.9	IN-S42DS5UW

**Label Specifications**

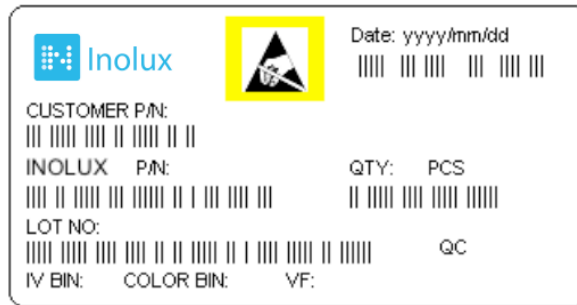

**Inolux P/N:**

I	N	-	S	4	2	D	S	5	-	-	-	-	-
Inolux SMD		Material	Package	Variation		Orientation	Current	Lens	Color	Customized Stamp-off			
		S = PCB Type	42D = 1.0 x 0.5 x 0.55mm			S = Side Mount	5=5mA	(Blank) = Clear U = Diffused	SR=631m R=624nm A=605nm Y=590nm YG=570nm G=520nm B=470nm W=White	-			

**Lot No.:**

Z	2	0	1	7	01	24	001
Internal Tracker	Year (2017, 2018, .....)				Month	Date	Serial

**Packaging Information: 4000pcs Per Reel**

**Tape Dimension**

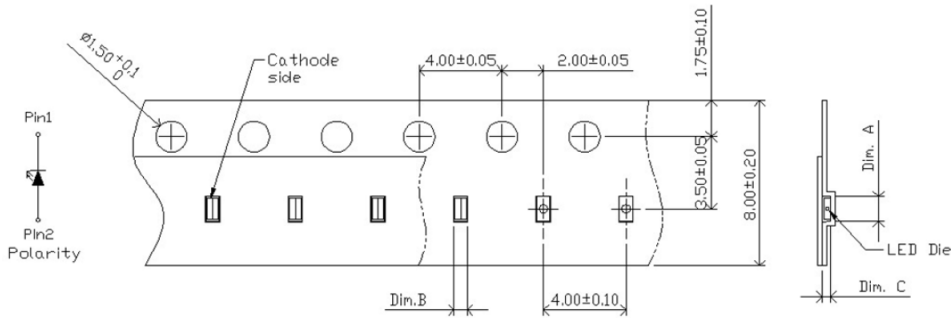

Dim. A	Dim. B	Dim. C	Q'ty/Reel
$1.2 \pm 0.05$	$0.65 \pm 0.05$	$0.42 \pm 0.05$	4K

**Reel Dimension**

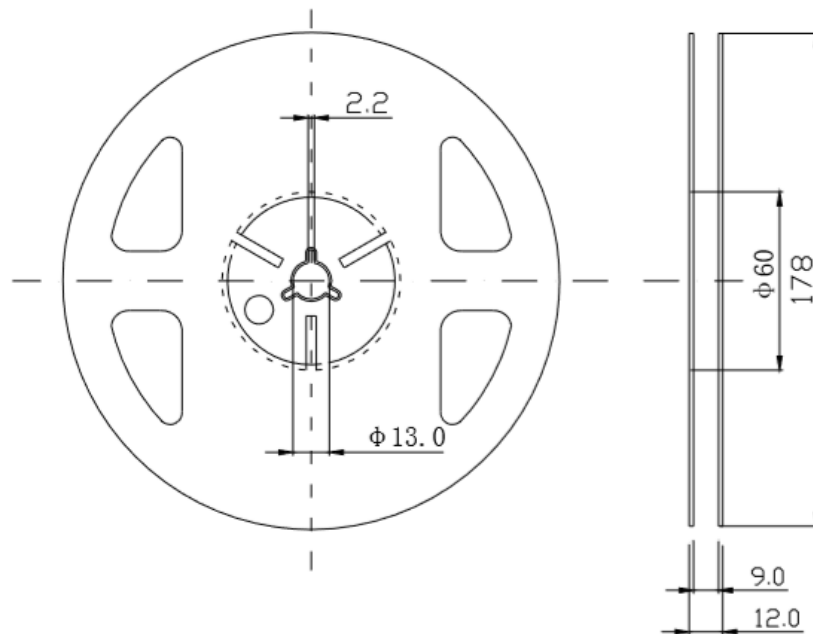

## Packing Dimension

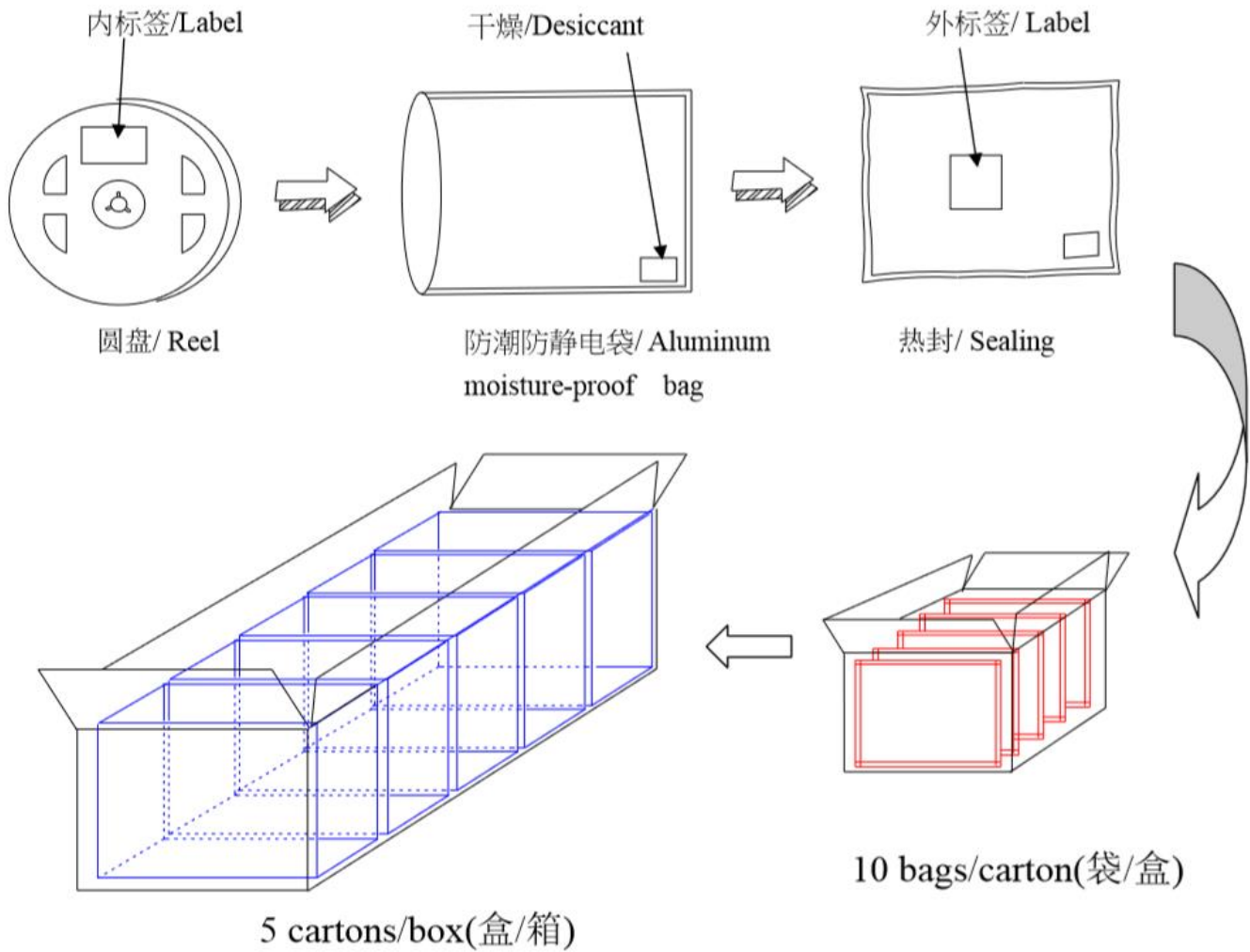



## Dry Pack

All SMD optical devices are **MOISTURE SENSITIVE**. Avoid exposure to moisture at all times during transportation or storage. Every reel is packaged in a moisture protected anti-static bag. Each bag is properly sealed prior to shipment.

Upon request, a humidity indicator will be included in the moisture protected anti-static bag prior to shipment.

The packaging sequence is as follows:

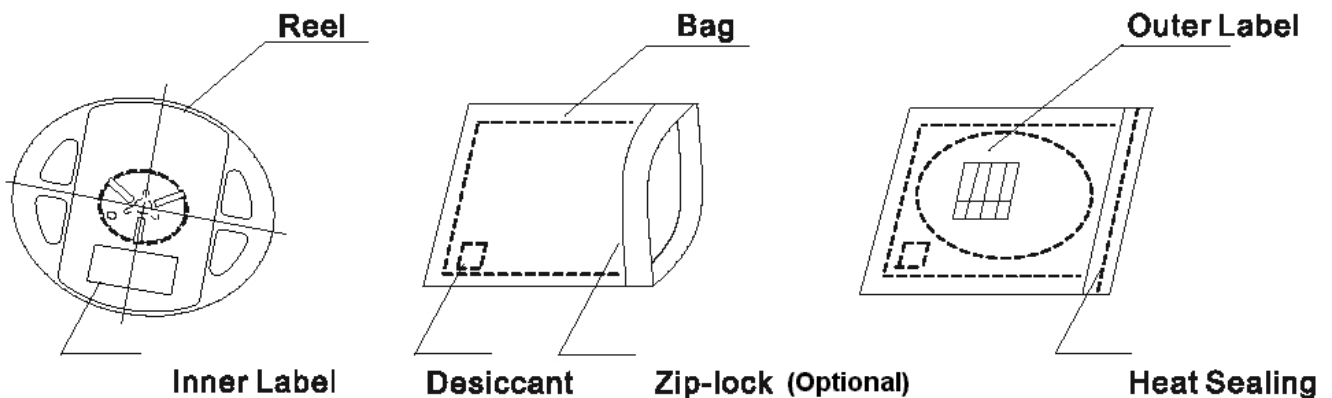

## Reflow Soldering

- Recommended tin glue specifications: melting temperature in the range of 178~192 °C
- The recommended reflow soldering profile is as follows (temperatures indicated are as measured on the surface of the LED resin):

Lead-free Solder Profile

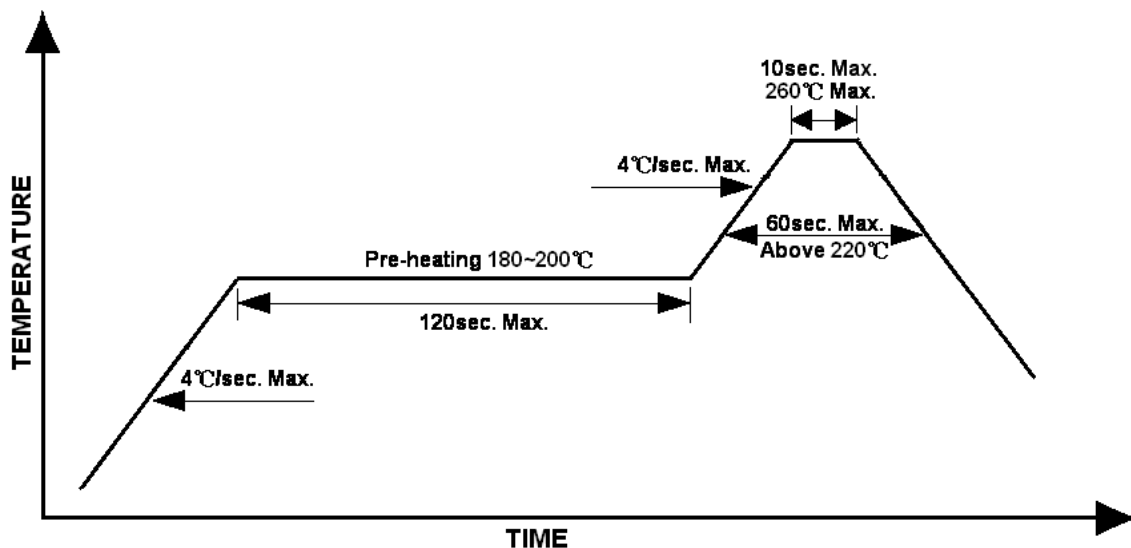

## Precautions

- Avoid exposure to moisture at all times during transportation or storage.
- Anti-Static precaution must be taken when handling GaN, InGaN, and AlInGaP products.
- It is suggested to connect the unit with a current limiting resistor of the proper size. Avoid applying a reverse voltage.
- Avoid operation beyond the limits as specified by the absolute maximum ratings.
- Avoid direct contact with the surface through which the LED emits light.
- If possible, assemble the unit in a clean room or dust-free environment.

## Reworking

- Rework should be completed within 5 seconds under 260 °C.
- The iron tip must not come in contact with the copper foil.
- Twin-head type is preferred.

## Cleaning

Following are cleaning procedures after soldering:

- An alcohol-based solvent such as isopropyl alcohol (IPA) is recommended.
- Temperature x Time should be 50°C x 30sec. or <30°C x 3min
- Ultra sonic cleaning: < 15W/ bath; bath volume ≤ 1liter
- Curing: 100 °C max, <3min

## Cautions of Pick and Place

- Avoid stress on the resin at elevated temperature.
- Avoid rubbing or scraping the resin by any object.
- Electro-static may cause damage to the component. Please ensure that the equipment is properly grounded. Use of an ionizer fan is recommended.

**Reliability**

Item	Frequency/ lots/ samples/ failures	Standards Reference	Conditions
Precondition	For all reliability monitoring tests according to JEDEC Level 2	J-STD-020	1.) Baking at 85°C for 24hrs 2.) Moisture storage at 85°C/ 60% R.H. for 168hrs
Solderability	1Q/ 1/ 22/ 0	JESD22-B102-B And CNS-5068	Accelerated aging 155°C/ 24hrs Tinning speed: 2.5+0.5cm/s Tinning: A: 215°C/ 3+1s or B: 260°C/ 10+1s
Resistance to soldering heat		CNS-5067	Dipping soldering terminal only Soldering bath temperature A: 260+/-5°C; 10+/-1s B: 350+/-10°C; 3+/-0.5s
Operating life test	1Q/ 1/ 40/ 0	CNS-11829	1.) Precondition: 85°C baking for 24hrs 85°C/ 60%R.H. for 168hrs 2.) Tamb25°C; IF=20mA; duration 1000hrs
High humidity, high temperature bias	1Q/ 1/ 45/ 0	JESD-A101-B	Tamb: 85°C Humidity: 85% R.H., IF=5mA Duration: 1000hrs
High temperature bias	1Q/ 1/ 20	IN specs.	Tamb: 55°C IF=20mA Duration: 1000hrs
Pulse life test	1Q/ 1/ 40/ 0		Tamb25°C, If=20mA,, Ip=100mA, Duty cycle=0.125 (tp=125 μs, T=1sec) Duration 500hrs)
Temperature cycle	1Q/ 1/ 76/ 0	JESD-A104-A IEC 68-2-14, Nb	A cycle: -40 degree C 15min; +85 degree C 15min Thermal steady within 5 min.. 300 cycles 2 chamber/ Air-to-air type
High humidity storage test	1Q/ 1/ 40/ 0	CNS-6117	60+3°C 90+5/-10% R.H. for 500hrs
High temperature storage test	1Q/ 1/ 40/ 0	CNS-554	100+10°C for 500hrs
Low temperature storage test	1Q/ 1/ 40/ 0	CNS-6118	-40+5°C for 500hrs

## Revision History

Changes since last revision	Page	Version No.	Revision Date
Initial Release		1.0	05-14-2021

## DISCLAIMER

INOLUX reserves the right to make changes without further notice to any products herein to improve reliability, function or design. INOLUX does not assume any liability arising out of the application or use of any product or circuit described herein; neither does it convey any license under its patent rights, nor the rights of others.

## LIFE SUPPORT POLICY

INOLUX's products are not authorized for use as critical components in life support devices or systems without the express written approval of the President of INOLUX or INOLUX CORPORATION. As used herein:

1. Life support devices or systems are devices or systems which, (a) are intended for surgical implant into the body, or (b) support or sustain life, and (c) whose failure to perform when properly used in accordance with instructions for use provided in the labeling, can be reasonably expected to result in a significant injury of the user.
2. A critical component in any component of a life support device or system whose failure to perform can be reasonably expected to cause the failure of the life support device or system, or to affect its safety or effectiveness.

## X-ON Electronics

Largest Supplier of Electrical and Electronic Components

*Click to view similar products for [Standard LEDs - SMD category](#):*

*Click to view products by [Inolux manufacturer](#):*

Other Similar products are found below :

[LTST-C19GD2WT](#) [LTST-N683GBEW](#) [LTW-170ZDC](#) [LTW-M140SZS40](#) [598-8110-100F](#) [598-8170-100F](#) [598-8610-202F](#) [67-22VRVGC/TR8](#) [AAAF5060QBFSEEZGS](#) [HLMP-6305-L0011](#) [ALMD-LB36-SV002](#) [APT1608QGW](#) [15-21UYC/S530-A3/TR8](#) [EASV1803BA0](#) [LG M67K-H1J2-24-0-2-R18-Z](#) [LS A676-P2S1-1](#) [SML310BATT86](#) [SML-512VWT86A](#) [SML-LX0606SISUGC/A](#) [SML-LXL1307SRC-TR](#) [SML-LXR851SIUPGUBC](#) [LT1ED53A](#) [FAT801-S](#) [AM27ZGC03](#) [APB3025SGNC](#) [APFA3010SURKCGKQBDC](#) [APHK1608VGCA](#) [APT2012QGW](#) [CLX6D-FKB-CN1R1H1BB7D3D3](#) [LTST-C250KGKT](#) [LTW-020ZDCG](#) [LTW-21TS5](#) [LTW-220DS5](#) [JANTXM19500/521-02](#) [UYGT801-S](#) [LO T67F-V1AB-24-1](#) [YGFR411-H](#) [598-8330-117F](#) [SML-LX0402IC-TR](#) [CMDA20AYAA7D1S](#) [CMDA16AYDR7A1X](#) [339-1SURYGW/S530-A2](#) [598-8040-100F](#) [598-8070-100F](#) [598-8140-100F](#) [598-8610-200F](#) [EAPL3527GA5](#) [67-11/BHC-M1N2B8Y/2A0](#) [SML-LXL1209SYC/ATR](#) [EASV3020YGA0](#)