

4 Construction & Dimensions

4.1 Substrate : Ceramic (Alumina)

4.2 Encapsulate : Polymer

4.3 Electrodes : Silver Palladium (Ag/Pd)

4.4 End termination : Ag/Ni/Sn ※(CONTROL LEVEL : A)

4.5 Construction & Dimension :

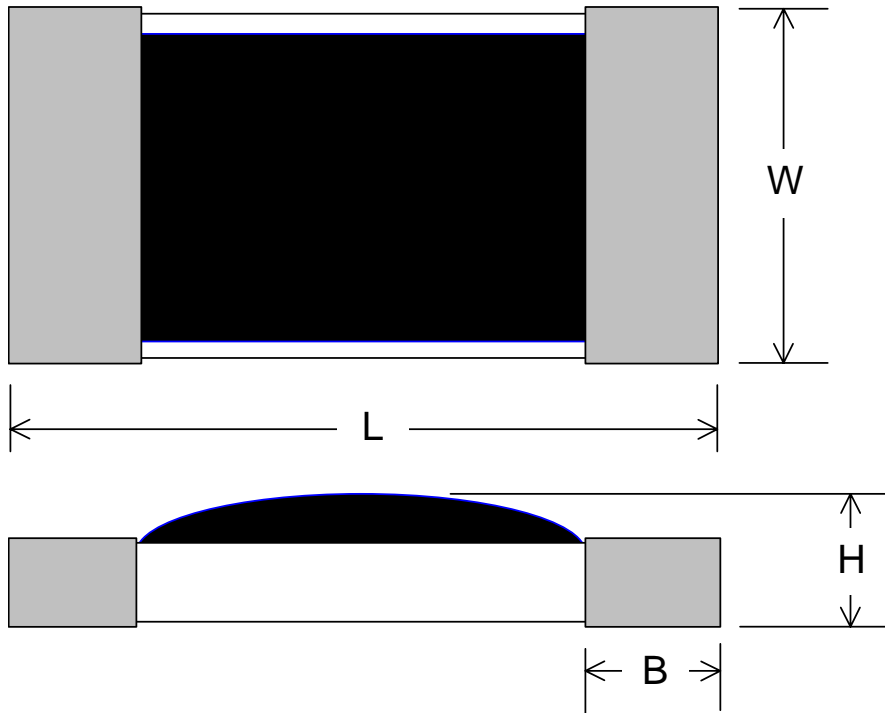

Unit: mm

L	W	H	B
1.6±0.1	0.85±0.15	0.51±0.05	0.3±0.2

UNLESS OTHER SPECIFIED TOLERANCES ON :

X=± X.X=± X.XX=±

ANGLES=± HOLEDIA=±

SCALE : XXXX

UNIT : XXXX

DRAWN BY : 彭郁喬 *Jaise*

CHECKED BY : 劉德邦 *Alan*

DESIGNED BY : 劉德邦 *Alan*

APPROVED BY : 劉元文 *Alan*



佳邦科技股份有限公司

INPAQ TECHNOLOGY CO., Ltd

THIS DRAWINGS AND SPECIFICATIONS ARE THE PROPERTY OF INPAQ TECHNOLOGY CO.,LTD.AND SHALL NOT BE REPRODUCED OR USED AS THE BASIS FOR THE MANUFACTURE OR SALE OF APPARATUS OR DEVICES WITHOUT PERMISSION

TITLE : EGA10603V05A1-B Engineering Specification

DOCUMENT NO.

000111401059

SPEC REV. A5

5 General specifications

5.1 General technical data

Item	Typical
Rated voltage	5 V
Leakage current	0.01 μ A
Trigger voltage	150 V

5.2 Temperature Specifications

Operating Temperature range : -40°C to +85°C

Storage Temperature range : -55°C to +125°C

5.3 Environmental Specifications

Item	Specifications	Test condition
Bias humidity	$I_L \leq 10 \mu\text{A}$	90%RH, 40°C, rated voltage, 1000 hr
Thermal Shock	$I_L \leq 10 \mu\text{A}$	-40°C to 85°C, 30 min. cycle, 5 cycles
Full load voltage	$I_L \leq 10 \mu\text{A}$	Rated voltage, 85°C, 1000 hr
Solder leach resistance	$I_L \leq 10 \mu\text{A}$	260°C, 10s

I_L – Leakage current at rated voltage, the maximum leakage current was measured after reliability test.

UNLESS OTHER SPECIFIED TOLERANCES ON :

X=± X.X=± X.XX=±

ANGLES=± HOLEDIA=±

SCALE : XXXX

UNIT : XXXX

DRAWN BY : 彭郁喬 *Jase*

CHECKED BY : 劉德邦 *Alan*

DESIGNED BY : 劉德邦 *Alan*

APPROVED BY : 劉元文 *Alan*

TITLE : EGA10603V05A1-B Engineering Specification



佳邦科技股份有限公司
INPAQ TECHNOLOGY CO., Ltd

THIS DRAWINGS AND SPECIFICATIONS ARE THE PROPERTY OF INPAQ TECHNOLOGY CO.,LTD.AND SHALL NOT BE REPRODUCED OR USED AS THE BASIS FOR THE MANUFACTURE OR SALE OF APPARATUS OR DEVICES WITHOUT PERMISSION

DOCUMENT NO.

000111401059

SPEC REV. A5

6 Performance Characteristics

	Symbol	Unit	Min.	Typical	Max.
Clamping voltage	Vc	V		30	
Capacitance, @1MHz	Cp	pF		0.2	0.5
Response time		ns			1
ESD voltage capability, Contact discharge mode		kV		8	15
ESD voltage capability, Air discharge mode		kV		15	25
ESD pulse withstand		pulses		100	

Vc – Per IEC 61000-4-2, 30A@8kV, level 4, clamp measurement made 30 ns after initiation of pulse, all test in contact discharge mode

Cp – Device capacitance measured with 1Vrms

UNLESS OTHER SPECIFIED TOLERANCES ON :

X=± X.X=± X.XX=±

ANGLES=± HOLEDIA=±

SCALE : XXXX

UNIT : XXXX

DRAWN BY : 彭郁喬 *Jase*

CHECKED BY : 劉德邦 *Alan*

DESIGNED BY : 劉德邦 *Alan*

APPROVED BY : 劉元文 *Yuan*

TITLE : EGA10603V05A1-B Engineering
Specification



佳邦科技股份有限公司
INPAQ TECHNOLOGY CO., Ltd

THIS DRAWINGS AND SPECIFICATIONS ARE THE PROPERTY OF INPAQ TECHNOLOGY CO.,LTD.AND SHALL NOT BE REPRODUCED OR USED AS THE BASIS FOR THE MANUFACTURE OR SALE OF APPARATUS OR DEVICES WITHOUT PERMISSION

DOCUMENT
NO.

000111401059

SPEC REV.
A5

7 Taping Package and Label Marking

7.1 Packaging method

7.1.1 Products shall be heat-sealed in the chip pocket, spacing pitch 2-mm of paper carrier tape with cover tape, and the carrier tape shall be reeled to the reel.

7.1.2 Tape material to be paper. Tape thickness to be 0.60 ± 0.03 mm.

7.1.3 Cover tape adhesion to be 40 ± 15 grams.

7.2 Carrier tape dimensions

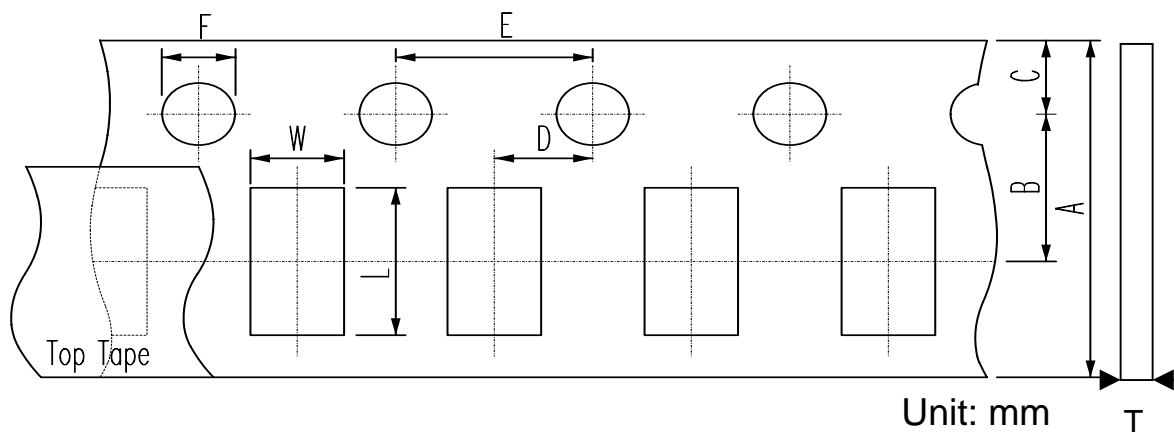

	0603
A	8.00 ± 0.30
B	3.50 ± 0.05
C	1.75 ± 0.10
D	2.00 ± 0.05
E	4.00 ± 0.10
F	1.50 ± 0.10
L	2.02 ± 0.20
W	1.27 ± 0.15
T	0.6 ± 0.03

UNLESS OTHER SPECIFIED TOLERANCES ON :

X=± X.X=± X.XX=±

ANGLES=± HOLEDIA=±

SCALE : XXXX

UNIT : XXXX

DRAWN BY : 彭郁喬 *Jase*

CHECKED BY : 劉德邦 *Alan*

DESIGNED BY : 劉德邦 *Alan*

APPROVED BY : 劉元文 *Alan*

TITLE : EGA10603V05A1-B Engineering Specification



佳邦科技股份有限公司

INPAQ TECHNOLOGY CO., Ltd

THIS DRAWINGS AND SPECIFICATIONS ARE THE PROPERTY OF INPAQ TECHNOLOGY CO.,LTD.AND SHALL NOT BE REPRODUCED OR USED AS THE BASIS FOR THE MANUFACTURE OR SALE OF APPARATUS OR DEVICES WITHOUT PERMISSION

DOCUMENT NO.

000111401059

SPEC REV. A5

7.3 Taping reel dimensions

Unit: mm

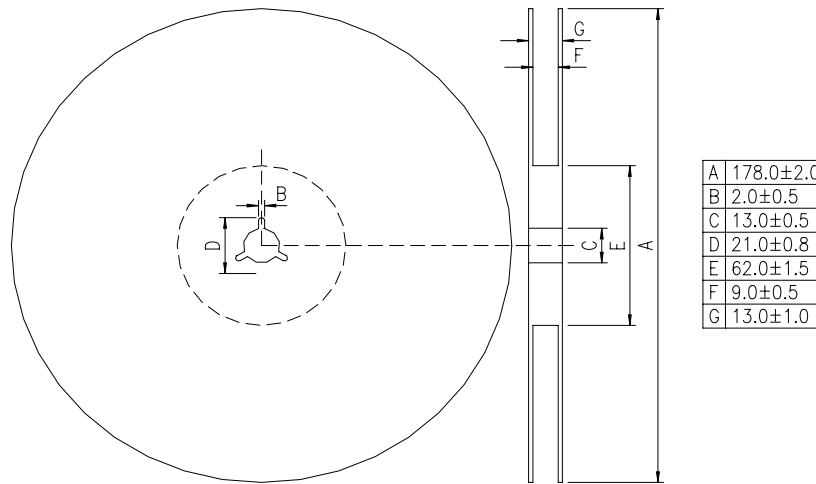

7.4 Taping specifications

There shall be the portion having no product in both the head and the end of taping, and there shall be the cover tape in the head of taping.

7.5 Label Marking

The label specified as follows shall be put on the side of reel.

- (1) Part No.
- (2) Quantity
- (3) Lot No.

* Part No. And Quantity shall be marked on outer packaging.

7.6 Quantity of products in the taping package

- (1) Standard quantity : 5000pcs/Reel for EGA10603V05A1-B
- (2) Shipping quantity is a multiple of standard quantity

UNLESS OTHER SPECIFIED TOLERANCES ON : X=± X.X=± X.XX=± ANGLES=± HOLEDIA=±		 佳邦科技股份有限公司 INPAQ TECHNOLOGY CO., Ltd
SCALE : XXXX	UNIT : XXXX	
DRAWN BY : 彭郁喬 <i>Jaise</i>	CHECKED BY : 劉德邦 <i>Alan</i>	THIS DRAWINGS AND SPECIFICATIONS ARE THE PROPERTY OF INPAQ TECHNOLOGY CO.,LTD.AND SHALL NOT BE REPRODUCED OR USED AS THE BASIS FOR THE MANUFACTURE OR SALE OF APPARATUS OR DEVICES WITHOUT PERMISSION
DESIGNED BY : 劉德邦 <i>Alan</i>	APPROVED BY : 劉元文 <i>Alan</i>	
TITLE : EGA10603V05A1-B Engineering Specification		
DOCUMENT NO.	000111401059	SPEC REV. A5

8 Precautions for Handling

8.1 Solder cream in reflow soldering

Refer to the recommendable land pattern as printing mask pattern for solder cream.

(1) Print solder in a thickness of 0.15 to 0.2 mm.

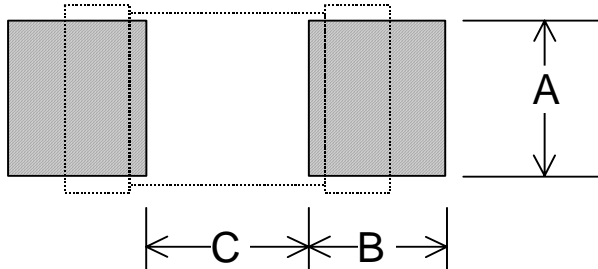

Unit : mm(inch)

A	0.75± 0.1 (0.03± 0.004)
B	0.75± 0.1 (0.03± 0.004)
C	0.75± 0.1 (0.03± 0.004)

8.2 Precaution for handling of substrate

Do not exceed to bend the board after soldering this product extremely. (reference examples)

- Mounting place must be as far as possible from the position, which is close to the break line of board, or on the line of large holes of board.
- Do not bend extremely the board, in mounting another components.

If necessary, use back-up pin (support pin) to prevent from bending extremely.

- Do not break the board by hand. We recommend to use the machine or the jig to break it.

UNLESS OTHER SPECIFIED TOLERANCES ON : X=± X.X=± X.XX=± ANGLES=± HOLEDIA=±		 佳邦科技股份有限公司 INPAQ TECHNOLOGY CO., Ltd			
SCALE : XXXX	UNIT : XXXX				
DRAWN BY : 彭郁喬 <i>Jase</i>	CHECKED BY : 劉德邦 <i>Alan</i>	<small>THIS DRAWINGS AND SPECIFICATIONS ARE THE PROPERTY OF INPAQ TECHNOLOGY CO.,LTD.AND SHALL NOT BE REPRODUCED OR USED AS THE BASIS FOR THE MANUFACTURE OR SALE OF APPARATUS OR DEVICES WITHOUT PERMISSION</small>			
DESIGNED BY : 劉德邦 <i>Alan</i>	APPROVED BY : 劉元文 <i>Alan</i>				
TITLE : EGA10603V05A1-B Engineering Specification		<table border="1"> <tbody> <tr> <td>DOCUMENT NO.</td> <td>000111401059</td> <td>SPEC REV. A5</td> </tr> </tbody> </table>	DOCUMENT NO.	000111401059	SPEC REV. A5
DOCUMENT NO.	000111401059	SPEC REV. A5			

8.3 Precaution for soldering

Note that this product will be easily damaged by rapid heating, rapid cooling or local heating.

Do not give heat shock over 100°C in the process of soldering. We recommend to take preheating and gradual cooling.

8.4 Recommendable reflow soldering

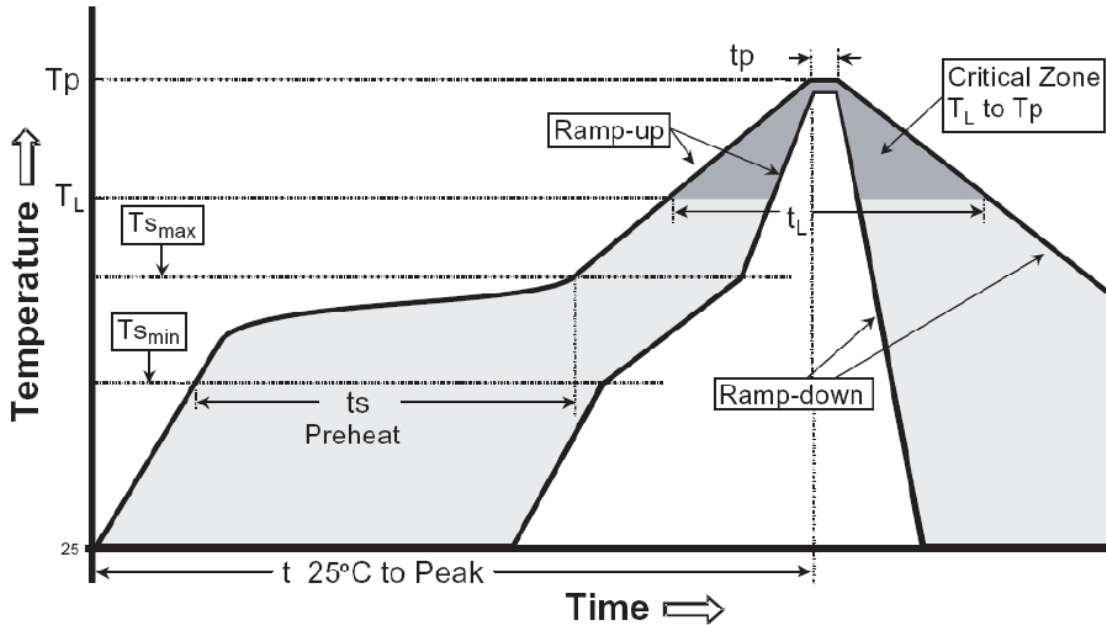

Profile Feature	Pb free Assembly
Average Ramp Rate (Ts max to Tp)	3 °C/second max
Preheat	
- Temperature Min (Ts _{min})	150°C
- Temperature Min (Ts _{max})	200°C
- Time(ts _{min} to ts _{min})	60-180 seconds
Time maintained above:	
- Temperature (T _L)	217°C
- Time (t _L)	60-150 seconds
Peak Temperature (T _p)	260°C +0/-5 °C
Time within 5 °C of actual Peak Temperature (T _p)	20-40 seconds
Ramp-Down Rate	6 °C/second max.
Time 25°C to Peak Temperature	8 minutes max

UNLESS OTHER SPECIFIED TOLERANCES ON :

X=± X.X=± X.XX=±

ANGLES=± HOLEDIA=±

SCALE : XXXX UNIT : XXXX

DRAWN BY : 彭郁喬 *Jane* CHECKED BY : 劉德邦 *Alan*

DESIGNED BY : 劉德邦 *Alan* APPROVED BY : 劉元文 *John*

TITLE : EGA10603V05A1-B Engineering Specification



佳邦科技股份有限公司

INPAQ TECHNOLOGY CO., Ltd

THIS DRAWINGS AND SPECIFICATIONS ARE THE PROPERTY OF INPAQ TECHNOLOGY CO.,LTD.AND SHALL NOT BE REPRODUCED OR USED AS THE BASIS FOR THE MANUFACTURE OR SALE OF APPARATUS OR DEVICES WITHOUT PERMISSION

DOCUMENT NO.

000111401059

SPEC REV. A5

8.5 Soldering gun procedure

Note the follows, in case of using solder gun for replacement.

(1) The tip temperature must be less than 280°C for the period within 3 seconds by using soldering gun under 30 W.

(2) The soldering gun tip shall not touch this product directly.

8.6 Soldering volume

Note that excess of soldering volume will easily get crack the body of this product.

8.7 Taping Package Storage Condition

Storage Temperature : 5 to 40 °C

Relative Humidity: < 65%RH

Storage Time : 12 months max

UNLESS OTHER SPECIFIED TOLERANCES ON :		 佳邦科技股份有限公司 INPAQ TECHNOLOGY CO., Ltd
X=±	X.X=±	
X.XX=±		THIS DRAWINGS AND SPECIFICATIONS ARE THE PROPERTY OF INPAQ TECHNOLOGY CO.,LTD.AND SHALL NOT BE REPRODUCED OR USED AS THE BASIS FOR THE MANUFACTURE OR SALE OF APPARATUS OR DEVICES WITHOUT PERMISSION
ANGLES=±	HOLEDIA=±	
SCALE : XXXX	UNIT : XXXX	DOCUMENT NO. 000111401059 SPEC REV. A5
DRAWN BY : 彭郁喬 <i>Jase</i>	CHECKED BY : 劉德邦 <i>Alan</i>	
DESIGNED BY : 劉德邦 <i>Alan</i>	APPROVED BY : 劉元文 <i>Yuan</i>	
TITLE : EGA10603V05A1-B Engineering Specification		

X-ON Electronics

Largest Supplier of Electrical and Electronic Components

Click to view similar products for [ESD Suppressors / TVS Diodes](#) category:

Click to view products by [Inpaq](#) manufacturer:

Other Similar products are found below :

[NTE4902](#) [P4SMAJ15A](#) [P4SMAJ26A](#) [SMAJ400CA-TP](#) [TGL34-47CA](#) [ESDAULC45-1BF4](#) [SM1605E3/TR13](#) [SMF20A-TP](#) [P4SMAJ12A](#)
[CPDUR24V-HF](#) [CPDQC5V0USP-HF](#) [CPDQC5V0-HF](#) [MPLAD30KP280A](#) [MPLAD30KP45CAE3](#) [MMBZ27VCLQ-7-F](#) [MMAD1108/TR13](#)
[MPLAD30KP24A](#) [MPLAD30KP30CAE3](#) [ACPDQC5V0R-HF](#) [DFLT170A-7](#) [NTE4900](#) [NTE4926](#) [NTE4938](#) [JANTX1N6144A](#)
[JANTX1N6057A](#) [SMF22A-TP](#) [SMF12A-TP](#) [SLVU2.8-TP](#) [SMLJ6.5CA-TP](#) [SMAJ6.5CA-TP](#) [MMAD1108E3/TR13](#) [JANTX1N6160A](#)
[D5V0M1U2LP3-7](#) [SMAJ400A-TP](#) [AOZ8811DT-03](#) [AOZ8831DI-05](#) [AOZ8831DT-03](#) [SMAJ188CA](#) [3SMC33CA BK](#) [CPDQC3V3C-HF](#)
[CPDQC12VE-HF](#) [GRPADATAJANTX1N6041A](#) [MPLAD30KP170CA](#) [82357120100](#) [5.0SMLJ15CA-TP](#) [5KP18A-TP](#) [P6KE8.2A-TP](#)
[MPLAD30KP43CAE3](#) [SMAJ43A-TP](#) [D26V0H1U2LP16-7](#)